

Load Switch ICs

# 0.5A Current Load Switch ICs for Portable Equipment

**BD6528HFV BD6529GUL**

**General Description**

BD6528HFV and BD6529GUL are high side switch IC using an N-Channel Power MOSFET and used as a power switch for memory card slot. This switch IC has an ON-Resistance of 100mΩ for BD6529GUL and 110mΩ for BD6528HFV. Operations using low input voltage ( $V_{IN} \geq 2.7V$ ) are possible for various switch applications. BD6528HFV is available in space-saving HVSO6 package.

**Key Specifications**

■ Switch Voltage Range	0V to 2.7V
■ Input Voltage Range:	2.7V to 4.5V
■ ON-Resistance:	
BD6528HFV	110mΩ(Typ)
BD6529GUL	100mΩ(Typ)
■ Output Current:	0.5 A(Max)
■ Standby Current:	0.01μA (Typ)
■ Operating Temperature Range:	-25°C to +85°C

**Features**

- Built-in Single N-Channel MOSFET with Low ON-Resistance
- Low-Voltage Switching Capability
- Soft-Start Function
- Output Discharge Circuit
- Reverse Current Flow Blocking at Switch OFF Condition

**Applications**

Load Switches for Mobile Phone, Digital Still Camera, PDA, MP3 Player, PC, etc.

**Packages**

W(Typ) D(Typ) H (Max)

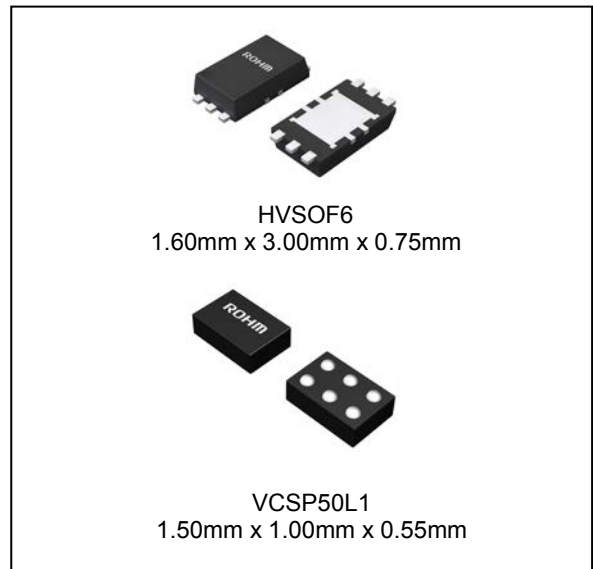

**Typical Application Circuit**

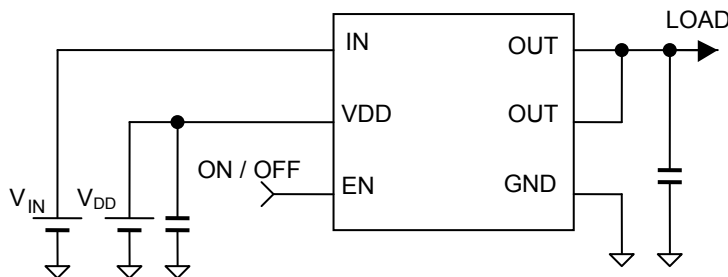

**Lineup**

ON-Resistance (Typ)	Control Input Logic	Package		Orderable Part Number
110mΩ	High	HVSO6	Reel of 3000	BD6528HFV-TR
100mΩ	High	VCSP50L1	Reel of 3000	BD6529GUL-E2

Block Diagram

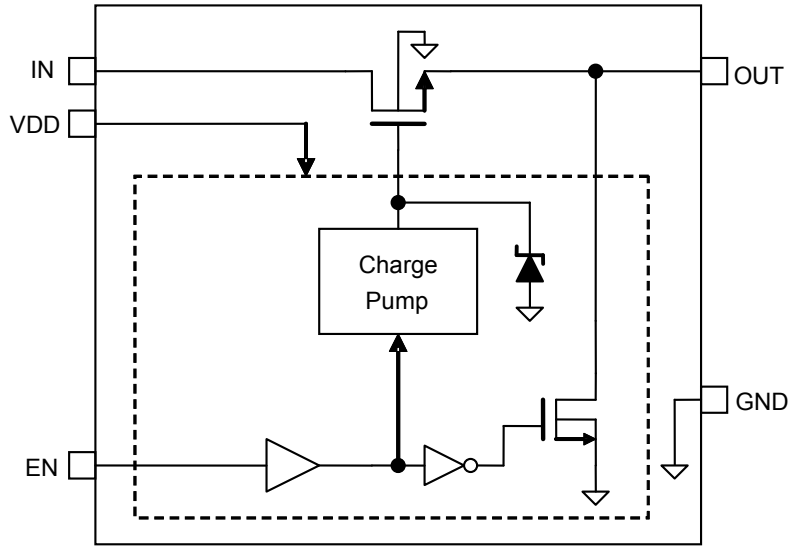

Pin Configuration

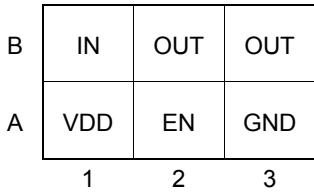

BD6529GUL (Bottom view)

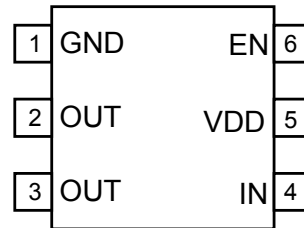

BD6528HFV (Top view)

Pin Description

Pin Number	Pin Name	Pin Function
1 (A3)	GND	Ground
2, 3 (B2, B3)	OUT	Switch output (connect each pin externally)
4 (B1)	IN	Switch input
5 (A1)	VDD	Power supply (for switch control and drive circuit)
6 (A2)	EN	Enable input (active-high input)

## Absolute Maximum Ratings

Parameter	Symbol	Rating	Unit
Supply Voltage	V <sub>DD</sub>	-0.3 to +6.0	V
IN Voltage	V <sub>IN</sub>	-0.3 to +6.0	V
EN Voltage	V <sub>EN</sub>	-0.3 to V <sub>DD</sub> +0.3	V
OUT Voltage	V <sub>OUT</sub>	-0.3 to +6.0	V
Storage Temperature	T <sub>stg</sub>	-55 to +150	°C
Power Dissipation	Pd	0.84 <sup>(Note 1)</sup> (BD6528HFV)	W
		0.57 <sup>(Note 2)</sup> (BD6529GUL)	

(Note 1) When mounted on 70mm x 70mm x 1.6mm Glass-epoxy PCB, derate by 6.8mW /°C at Ta > 25°C

(Note 2) When mounted on 50mm x 58mm x 1.75mm Glass-epoxy PCB, derate by 4.6mW /°C at Ta > 25°C

**Caution:** Operating the IC over the absolute maximum ratings may damage the IC. The damage can either be a short circuit between pins or an open circuit between pins and the internal circuitry. Therefore, it is important to consider circuit protection measures, such as adding a fuse, in case the IC is operated over the absolute maximum ratings.

## Recommended Operating Conditions

Parameter	Symbol	Rating			Unit
		Min	Typ	Max	
Operating Voltage	V <sub>DD</sub>	2.7	3.3	4.5	V
Switch Input Voltage	V <sub>IN</sub>	0	1.2	2.7	V
Operation Temperature	Topr	-25	+25	+85	°C
Output Current	I <sub>LO</sub>	0	-	500	mA

## Electrical Characteristics

BD6528HFV (Unless otherwise specified, V<sub>DD</sub> = 3.3V, V<sub>IN</sub> = 1.2V, Ta = 25°C)

Parameter	Symbol	Limit			Unit	Conditions
		Min	Typ	Max		
[Current Consumption]						
Operating Current	I <sub>DD</sub>	-	20	30	μA	V <sub>EN</sub> = 1.2V
Standby Current	I <sub>STB</sub>	-	0.01	1	μA	V <sub>EN</sub> = 0V
[I/O]						
EN Input Voltage	V <sub>ENH</sub>	1.2	-	-	V	High Level Input
	V <sub>ENL</sub>	-	-	0.4	V	Low Level Input
EN Input Current	I <sub>EN</sub>	-1	-	+1	μA	V <sub>EN</sub> = 0V or V <sub>EN</sub> = 1.2V
[Power Switch]						
ON-Resistance	R <sub>ON</sub>	-	110	-	mΩ	I <sub>OUT</sub> = 500mA
Switch Leakage Current	I <sub>LEAK</sub>	-	0.01	10	μA	V <sub>EN</sub> = 0V, V <sub>OUT</sub> = 0V
Output Rise Time	t <sub>ON1</sub>	-	0.5	1	ms	R <sub>L</sub> = 10Ω, V <sub>OUT</sub> 10% to 90%
Output Turn ON Time	t <sub>ON2</sub>	-	0.6	2	ms	R <sub>L</sub> = 10Ω, V <sub>EN</sub> High to V <sub>OUT</sub> 90%
Output Fall Time	t <sub>OFF1</sub>	-	1	20	μs	R <sub>L</sub> = 10Ω, V <sub>OUT</sub> 90% to 10%
Output Turn OFF Time	t <sub>OFF2</sub>	-	15	100	μs	R <sub>L</sub> = 10Ω, V <sub>EN</sub> Low to V <sub>OUT</sub> 10%
[Discharge Circuit]						
Discharge ON-Resistance	R <sub>DISC</sub>	-	70	110	Ω	I <sub>OUT</sub> = -1mA, V <sub>EN</sub> = 0V
Discharge Current	I <sub>DISC</sub>	-	15	20	mA	V <sub>OUT</sub> = 3.3V, V <sub>EN</sub> = 0V

**Electrical Characteristics - continued**

BD6529GUL (Unless otherwise specified,  $V_{DD} = 3.3V$ ,  $V_{IN} = 1.2V$ ,  $T_a = 25^\circ C$ )

Parameter	Symbol	Limit			Unit	Conditions
		Min	Typ	Max		
[Current Consumption]						
Operating Current	$I_{DD}$	-	20	30	$\mu A$	$V_{EN} = 1.2V$
Standby Current	$I_{STB}$	-	0.01	1	$\mu A$	$V_{EN} = 0V$
[I/O]						
EN Input Voltage	$V_{ENH}$	1.2	-	-	V	High Level Input
	$V_{ENL}$	-	-	0.4	V	Low Level Input
EN Input Current	$I_{EN}$	-1	-	+1	$\mu A$	$V_{EN} = 0V$ or $V_{EN} = 1.2V$
[Power Switch]						
ON-Resistance	$R_{ON}$	-	100	-	$m\Omega$	$I_{OUT} = 500mA$
Switch Leakage Current	$I_{LEAK}$	-	0.01	10	$\mu A$	$V_{EN} = 0V$ , $V_{OUT} = 0V$
Output Rise Time	$t_{ON1}$	-	0.5	1	ms	$R_L = 10\Omega$ , $V_{OUT}$ 10% to 90%
Output Turn ON Time	$t_{ON2}$	-	0.6	2	ms	$R_L = 10\Omega$ , $V_{EN}$ High to $V_{OUT}$ 90%
Output Fall Time	$t_{OFF1}$	-	0.1	4	$\mu s$	$R_L = 10\Omega$ , $V_{OUT}$ 90% to 10%
Output Turn OFF Time	$t_{OFF2}$	-	1	6	$\mu s$	$R_L = 10\Omega$ , $V_{EN}$ Low to $V_{OUT}$ 10%
[Discharge Circuit]						
Discharge ON-Resistance	$R_{DISC}$	-	70	110	$\Omega$	$I_{OUT} = -1mA$ , $V_{EN} = 0V$
Discharge Current	$I_{DISC}$	-	15	20	mA	$V_{OUT} = 3.3V$ , $V_{EN} = 0V$

**Measurement Circuit**

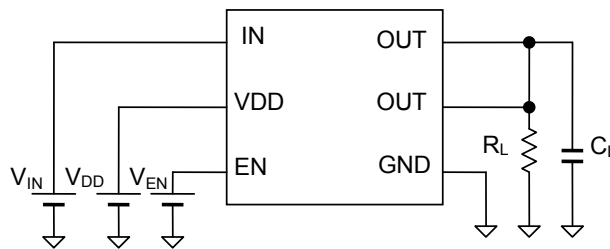

**Timing Diagram**

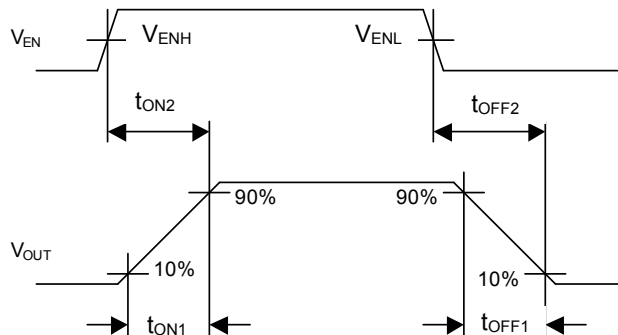

Typical Performance Curves

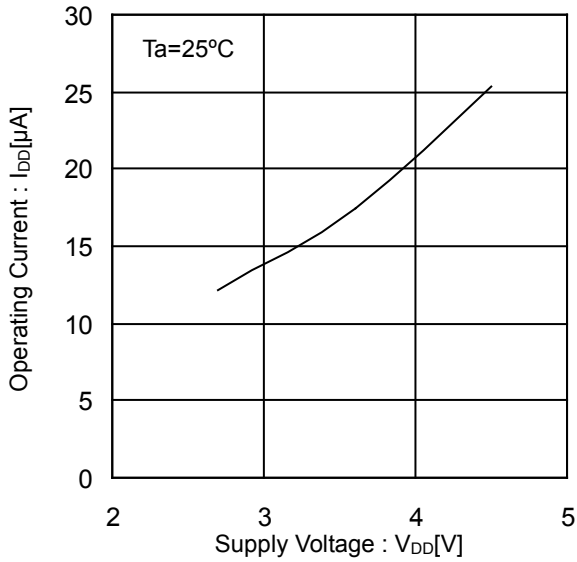

Figure 1. Operating Current vs Supply Voltage (EN Enable)

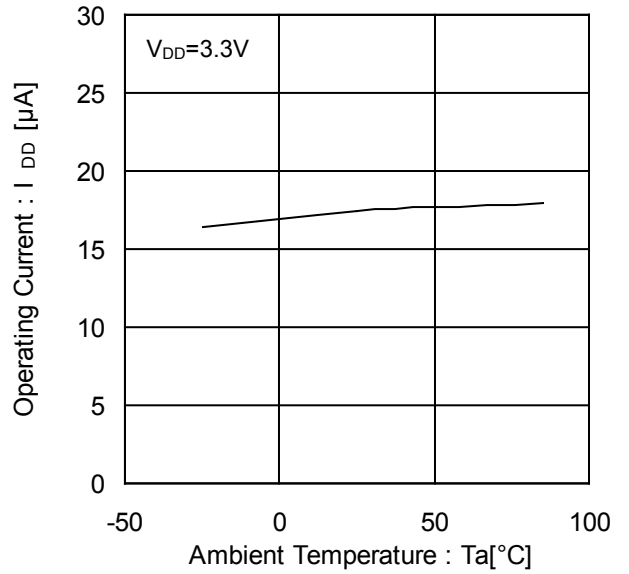

Figure 2. Operating Current vs Ambient Temperature (EN Enable)

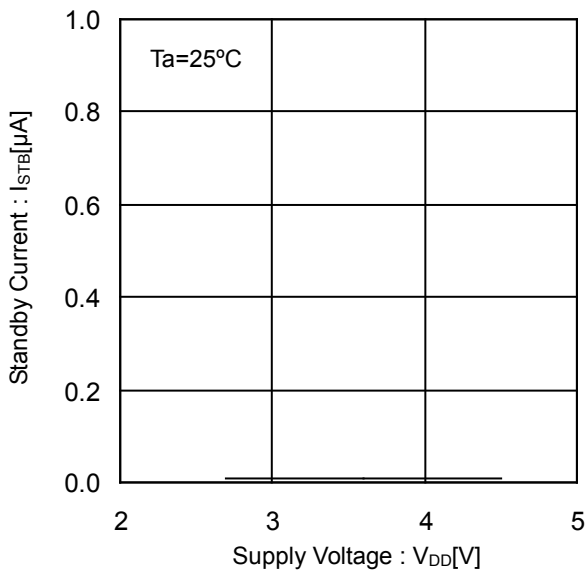

Figure 3. Standby Current vs Supply Voltage (EN Disable)

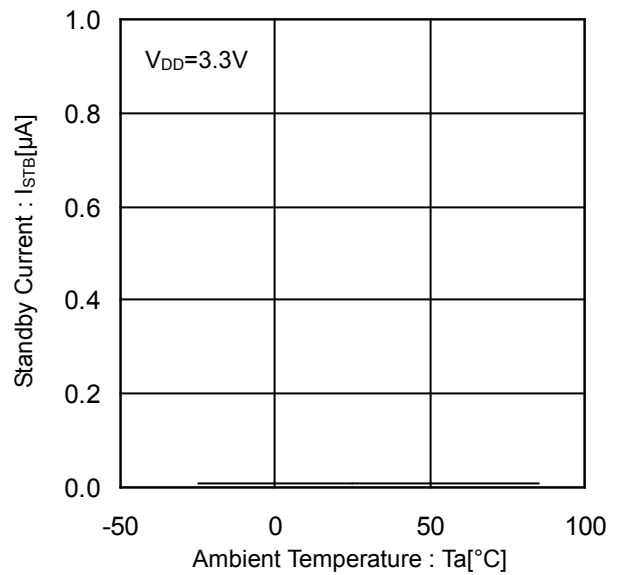

Figure 4. Standby Current vs Ambient Temperature (EN Disable)

Typical Performance Curves - continued

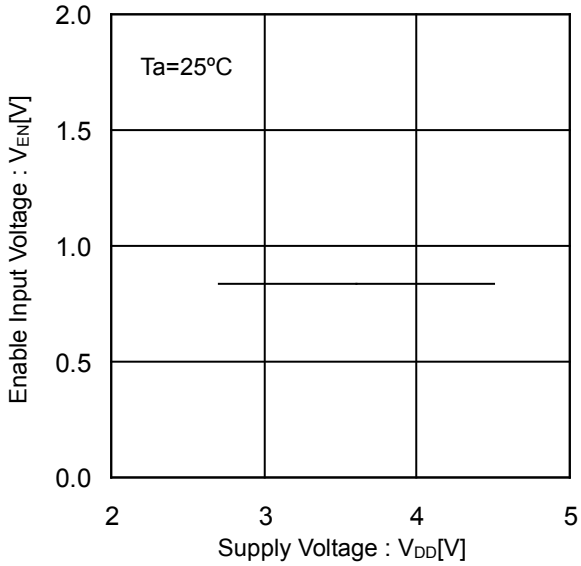

Figure 5. EN Input Voltage vs Supply Voltage

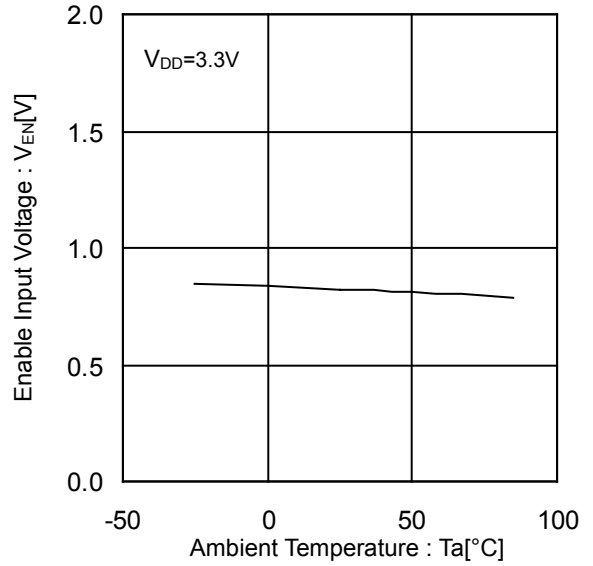

Figure 6. EN Input Voltage vs Ambient Temperature

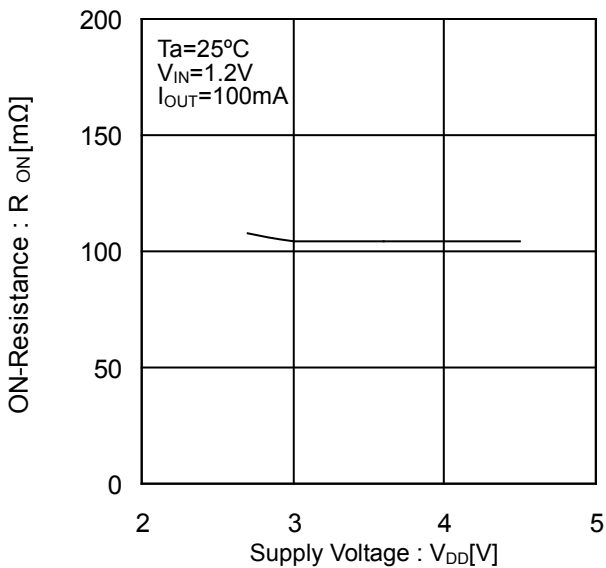

Figure 7. ON-Resistance vs Supply Voltage (BD6528HFV)

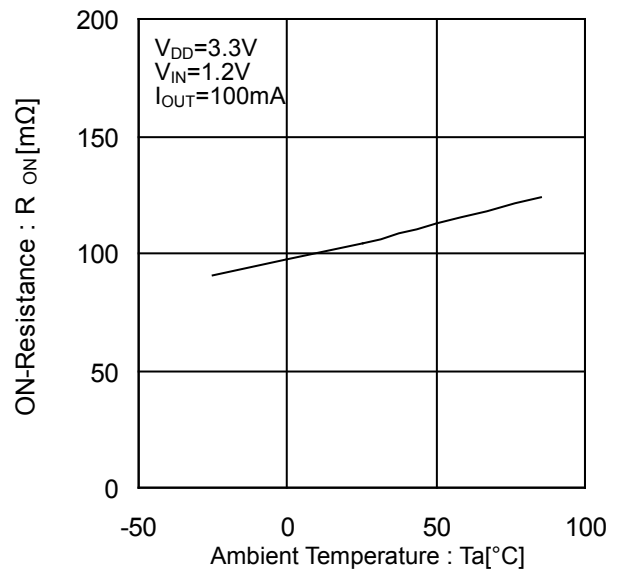

Figure 8. ON-Resistance vs Ambient Temperature (BD6528HFV)

Typical Performance Curves - continued

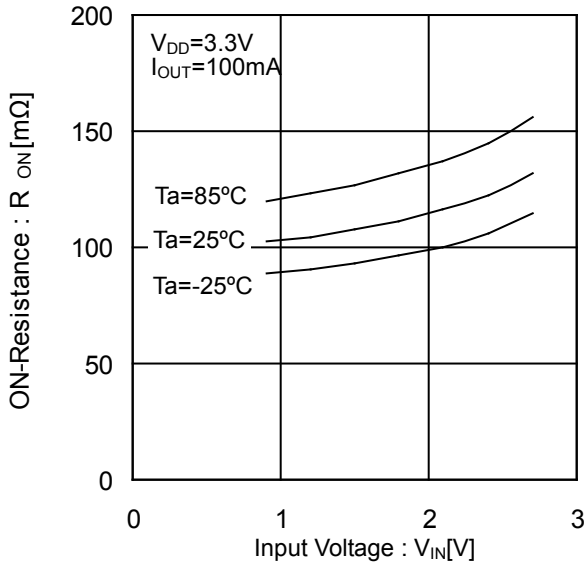

Figure 9. ON-Resistance vs Input Voltage (BD6528HFV)

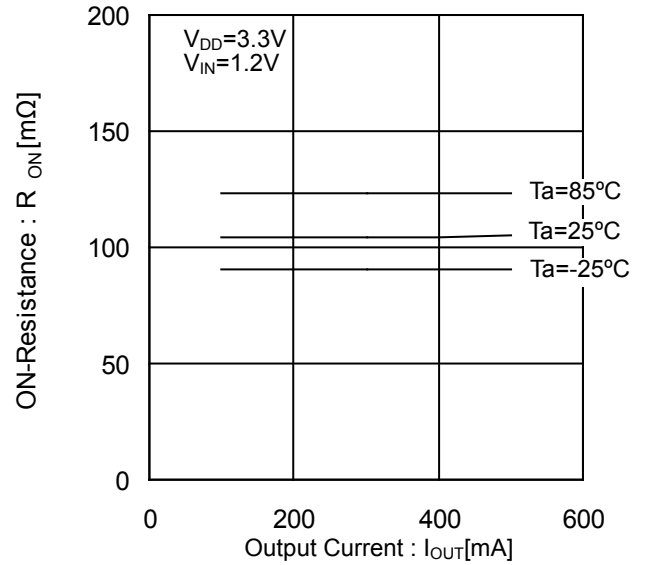

Figure 10. ON-Resistance vs Output Current (BD6528HFV)

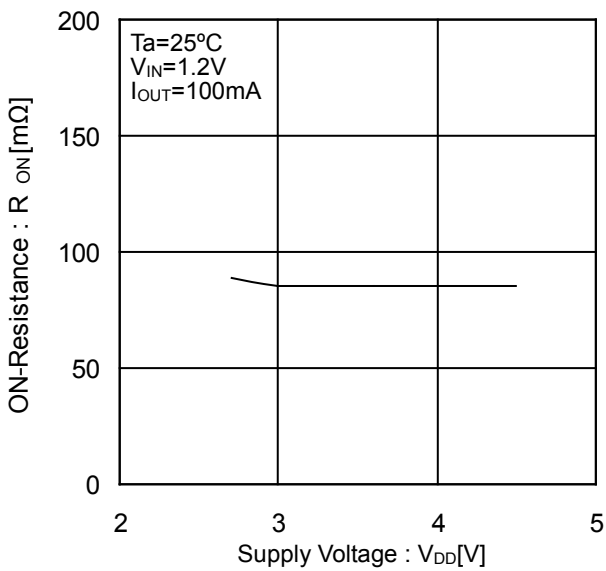

Figure 11. ON-Resistance vs Supply Voltage (BD6529GUL)

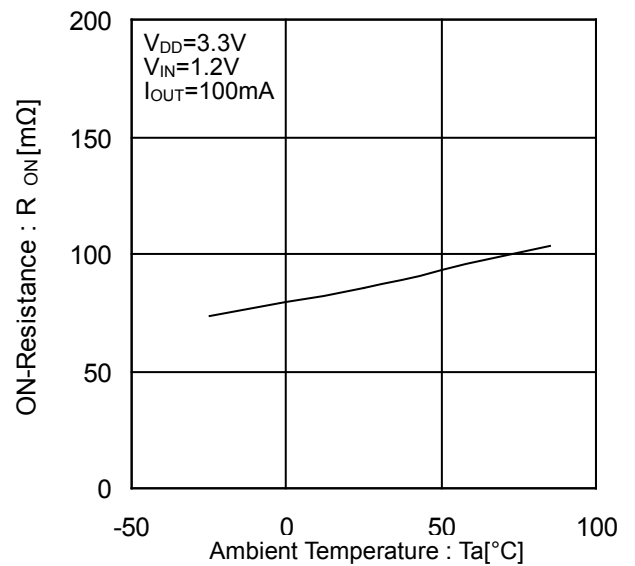

Figure 12. ON-Resistance vs Ambient Temperature (BD6529GUL)

Typical Performance Curves - continued

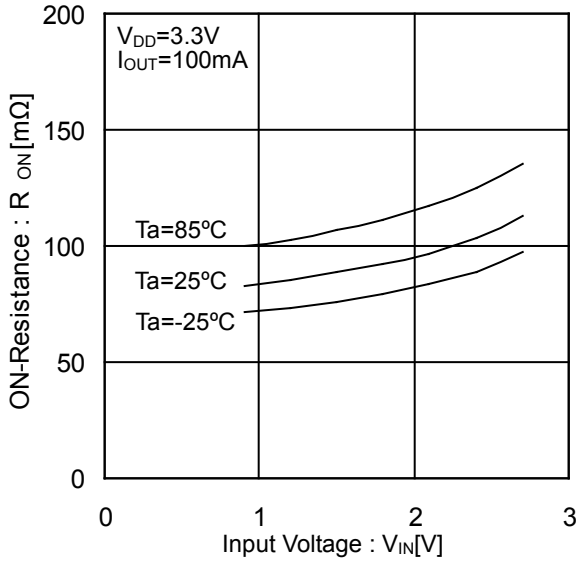

Figure 13. ON-Resistance vs Input Voltage (BD6529GUL)

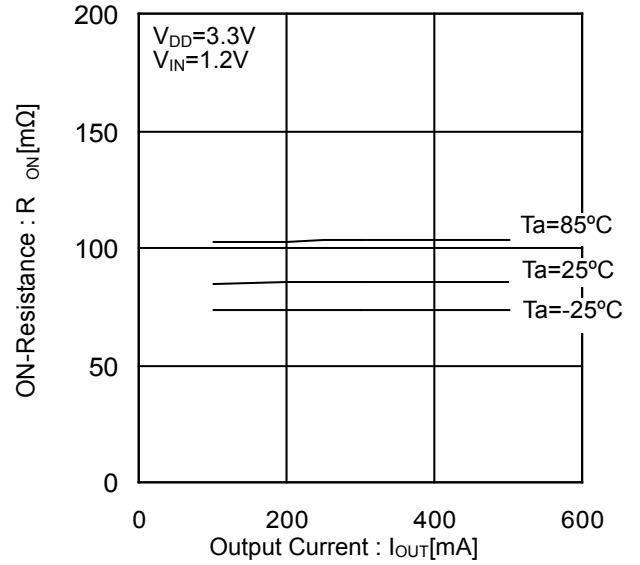

Figure 14. ON-Resistance vs Output Current (BD6529GUL)

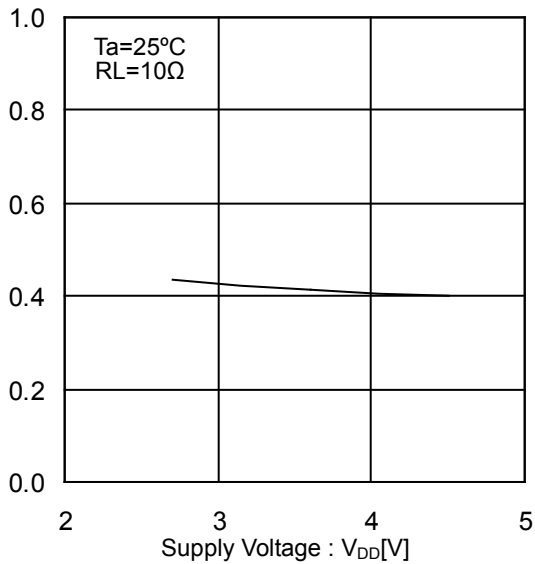

Figure 15. Output Rise Time vs Supply Voltage

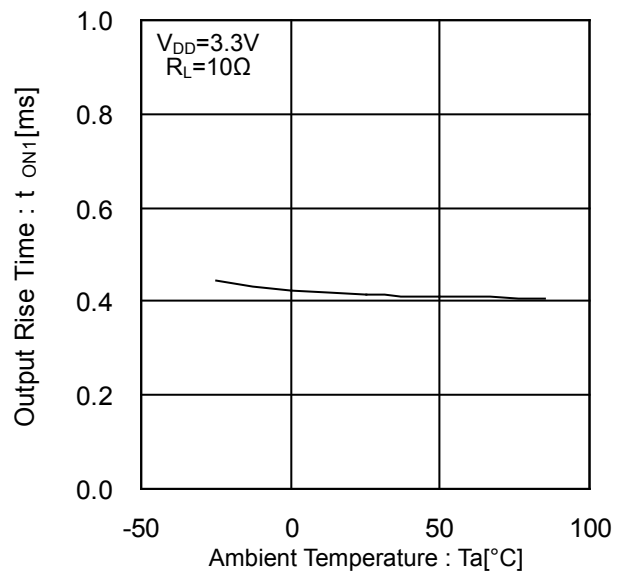

Figure 16. Output Rise Time vs Ambient Temperature



Typical Performance Curves - continued

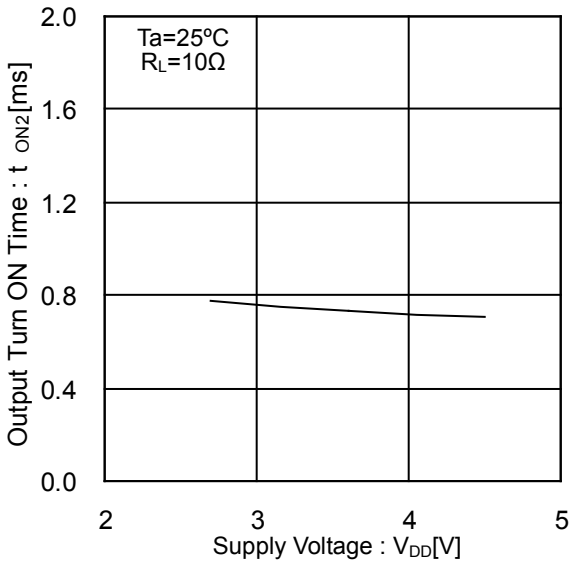

Figure 17. Output Turn ON Time vs Supply Voltage

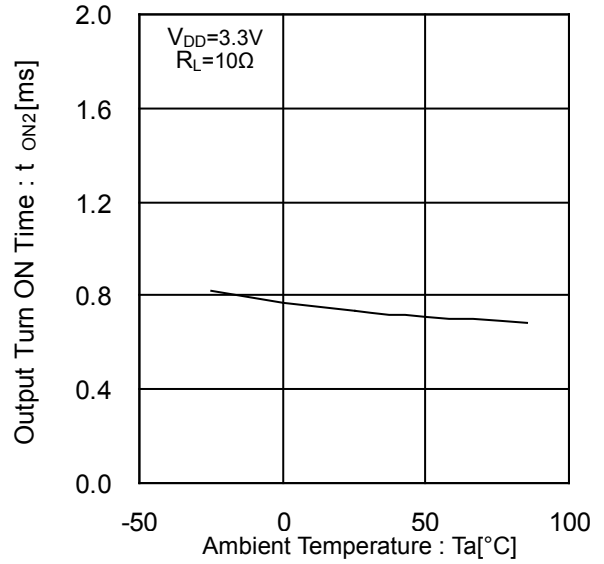

Figure 18. Output Turn ON Time vs Ambient Temperature

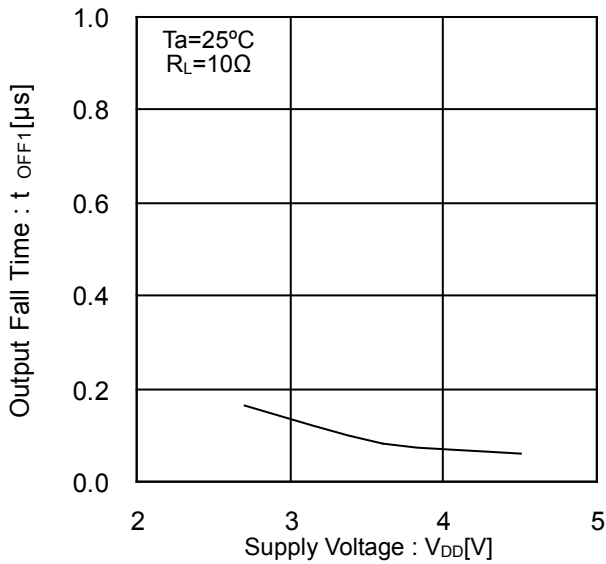

Figure 19. Output Fall Time vs Supply Voltage

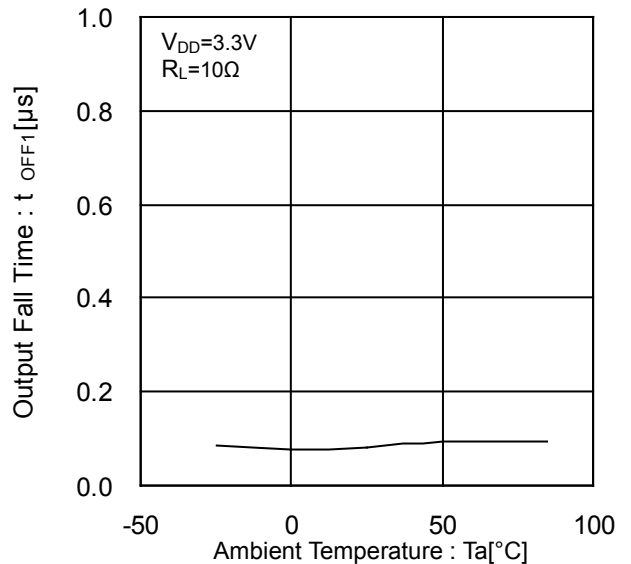

Figure 20. Output Fall Time vs Ambient Temperature

Typical Performance Curves - continued

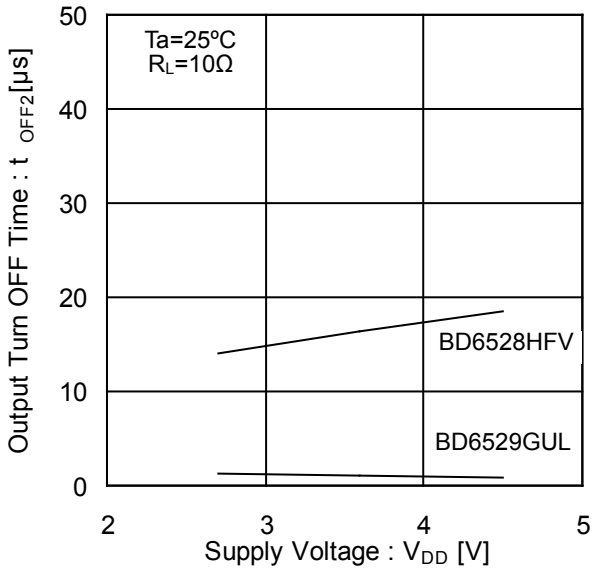

Figure 21. Output Turn OFF Time vs Supply Voltage

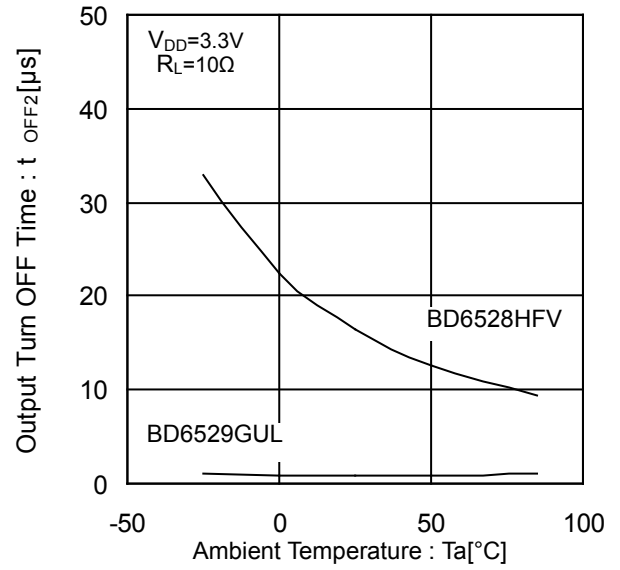

Figure 22. Output Turn OFF Time vs Ambient Temperature

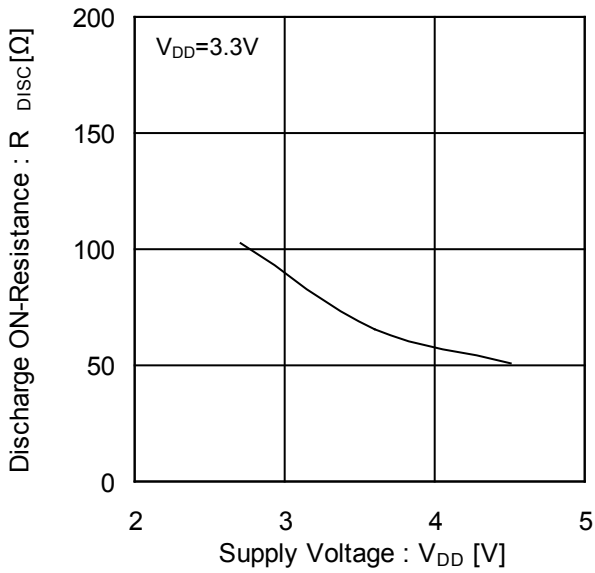

Figure 23. Discharge ON-Resistance vs Supply Voltage

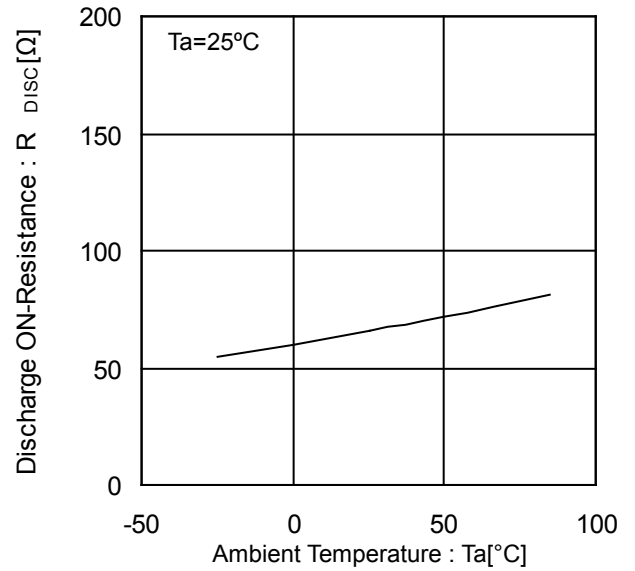

Figure 24. Discharge ON-Resistance vs Ambient Temperature

Typical Wave Forms

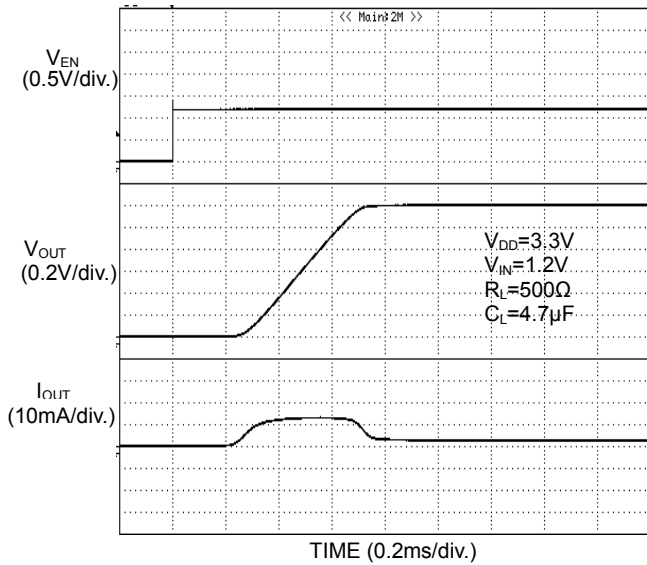

Figure 25. Output Turn ON Response  
BD6528HFV

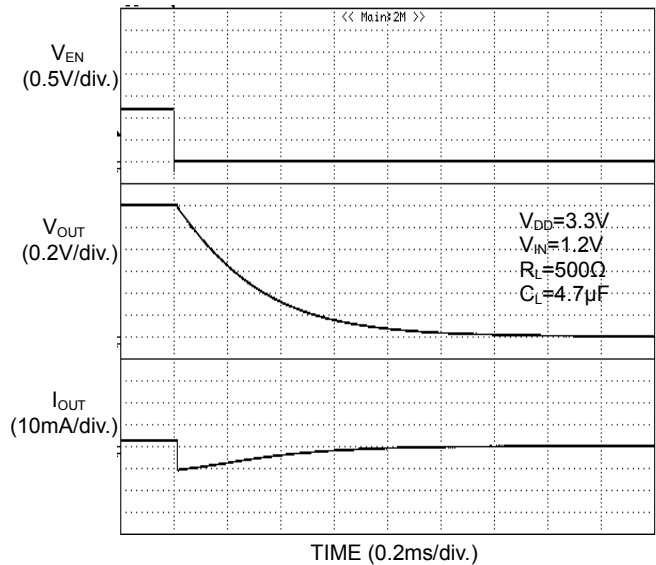

Figure 26. Output Turn OFF Response  
BD6528HFV

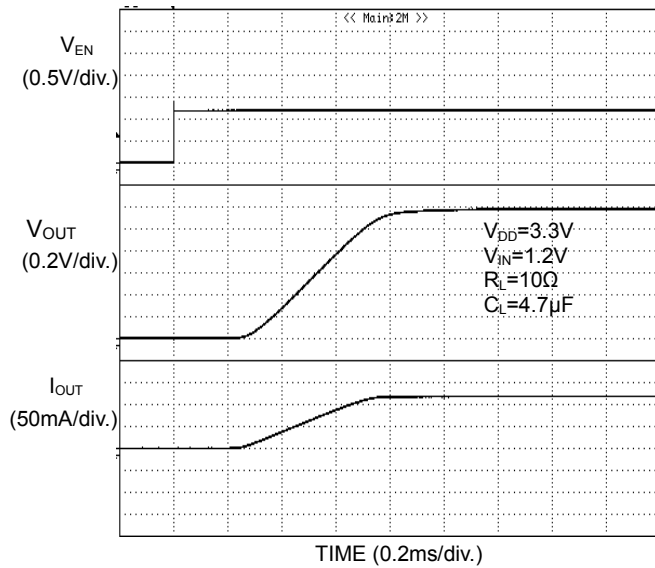

Figure 27. Output Turn ON Response  
BD6528HFV

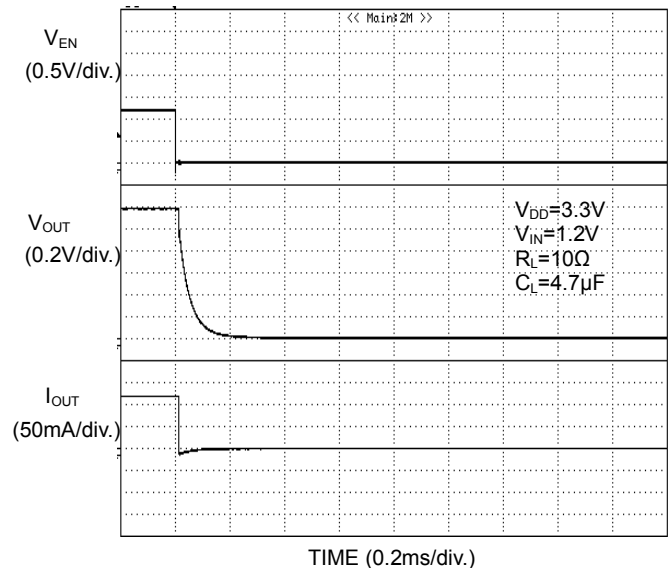

Figure 28. Output Turn OFF Response  
BD6528HFV

Typical Wave Forms - continued

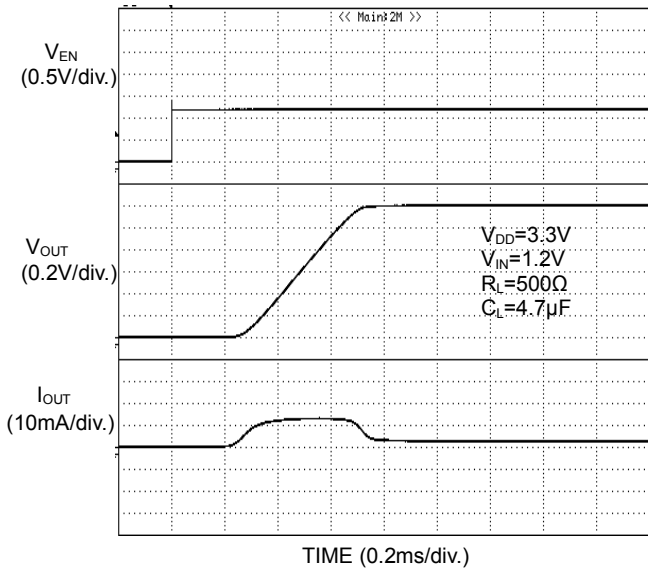

Figure 29. Output Turn ON Response  
BD6529GUL

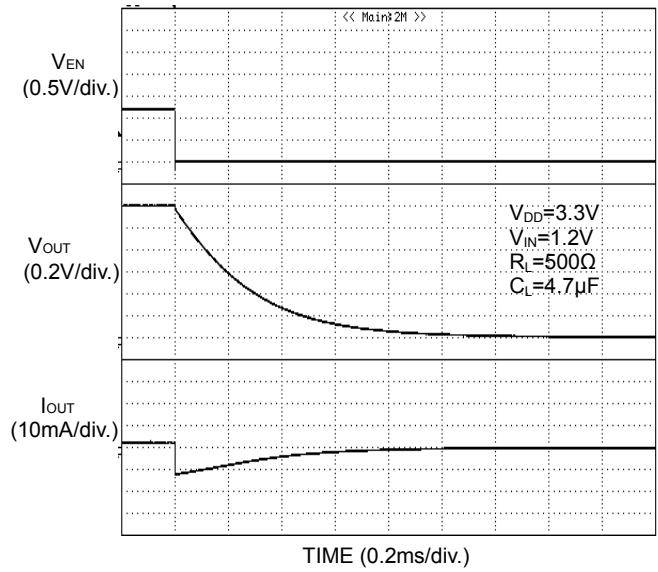

Figure 30. Output Turn OFF Response  
BD6529GUL

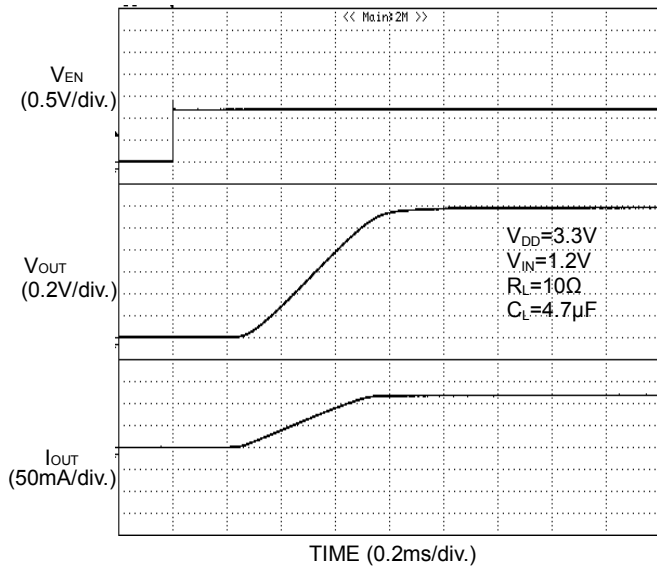

Figure 31. Output Turn ON Response  
BD6529GUL

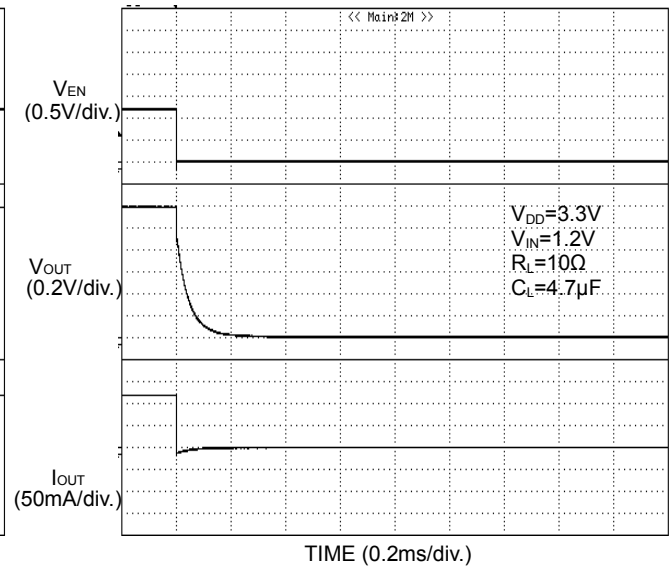

Figure 32. Output Turn OFF Response  
BD6529GUL

Typical Wave Forms - continued

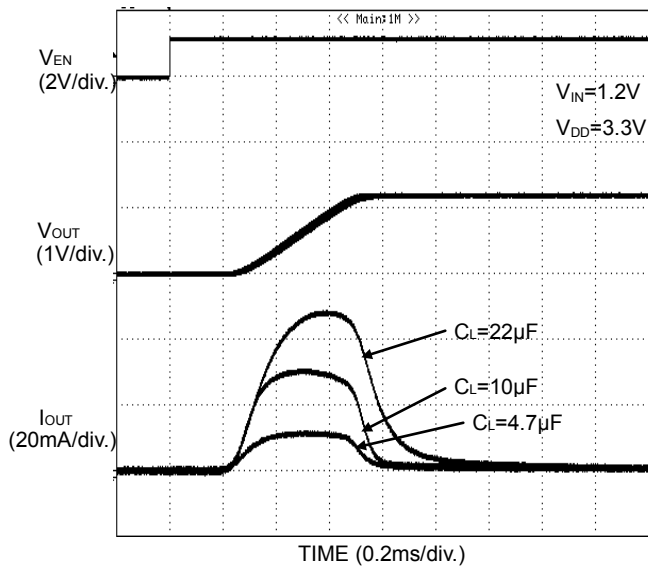
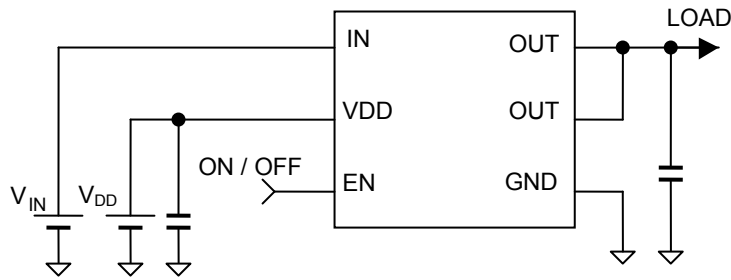

Figure 33. Rush Current Response

Typical Application Circuit



This application circuit does not guarantee its operation.

When the recommended external circuit components are changed, be sure to consider adequate margins by taking into account external parts and/or IC's dispersion including not only static characteristics, but also transient characteristics.

Functional Description

1. Switch Operation

Each IN and OUT pins are connected to MOSFET's drain and source respectively. By setting EN input to High level, the internal charge pump operates and turns on the MOSFET. When MOSFET is turned on, the switch's operation becomes bidirectional. Consequently, in case of  $V_{IN} < V_{OUT}$ , the current is flowing from OUT to IN.

Since there is no parasitic diode between switch's drain and source, the reverse flow of current from OUT to IN is prevented when the switch is at off condition.

2. Output Discharge Circuit

When the switch between the IN and OUT pins is turned OFF, the 70Ω (Typ) discharge switch between OUT and GND turns on. By turning on this switch, the electric charge at capacitive load is discharged quickly.

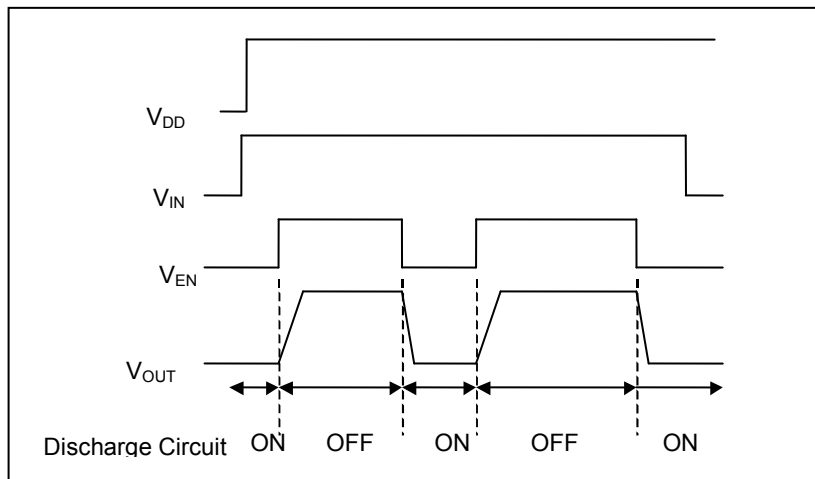

Figure 34. Operation Timing

Power Dissipation

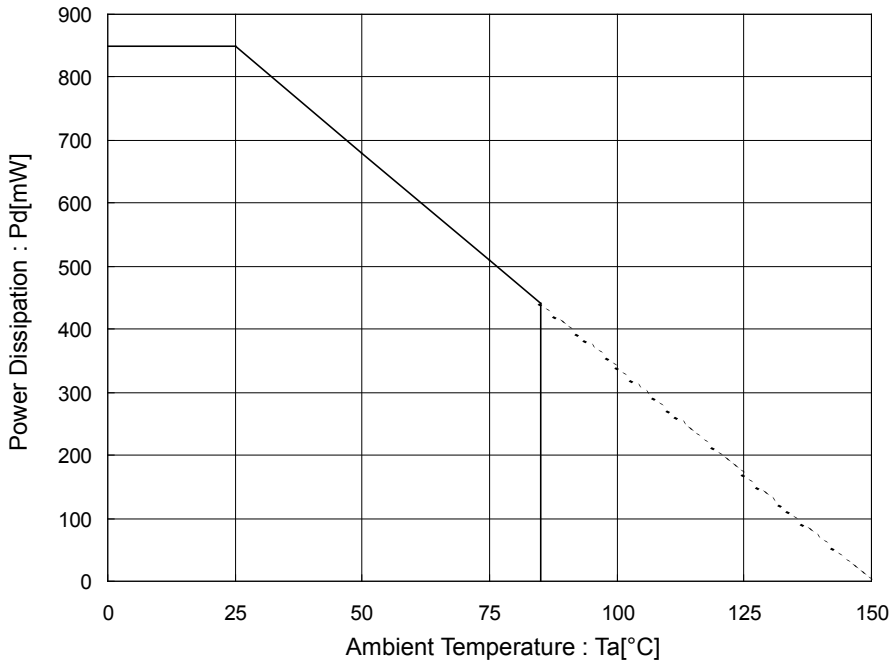

Figure 35. Power Dissipation Curve (Pd-Ta Curve)  
Mounted on 70mm x 70mm x 1.6mm Glass-epoxy PCB  
(HVSO6 Package)

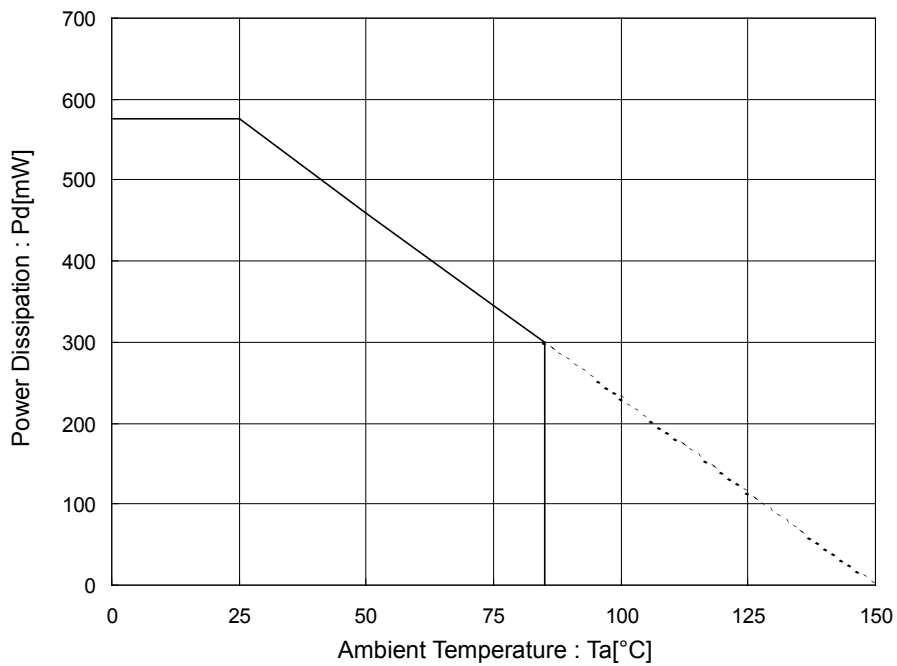
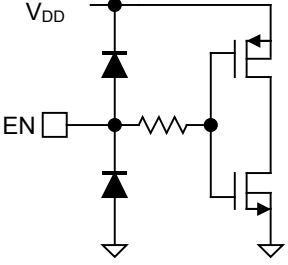
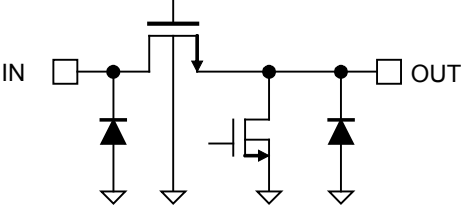

Figure 36. Power Dissipation Curve (Pd-Ta Curve)  
Mounted on 50mm x 58mm x 1.75mm Glass-epoxy PCB  
(VCSP50L1 Package)

I/O Equivalence Circuit

Pin Name	Pin Number	Equivalence Circuit
EN	6 (A2)	 <p>The diagram shows the EN pin connected to a pull-up resistor to V<sub>DD</sub> and a pull-down resistor to ground. The signal path continues through a CMOS buffer stage consisting of a PMOS transistor connected to V<sub>DD</sub> and an NMOS transistor connected to ground.</p>
IN OUT	4 (B1) 2, 3 (B2, B3)	 <p>The diagram shows an IN pin connected to a CMOS buffer stage. The output of the buffer is connected to an OUT pin. Schottky diodes are connected from the input and output nodes to ground for protection. The buffer stage consists of a PMOS transistor connected to V<sub>DD</sub> and an NMOS transistor connected to ground.</p>



## Operational Notes

### 1. Reverse Connection of Power Supply

Connecting the power supply in reverse polarity can damage the IC. Take precautions against reverse polarity when connecting the power supply, such as mounting an external diode between the power supply and the IC's power supply pins.

### 2. Power Supply Lines

Design the PCB layout pattern to provide low impedance supply lines. Separate the ground and supply lines of the digital and analog blocks to prevent noise in the ground and supply lines of the digital block from affecting the analog block. Furthermore, connect a capacitor to ground at all power supply pins. Consider the effect of temperature and aging on the capacitance value when using electrolytic capacitors.

### 3. Ground Voltage

Ensure that no pins are at a voltage below that of the ground pin at any time, even during transient condition.

### 4. Ground Wiring Pattern

When using both small-signal and large-current ground traces, the two ground traces should be routed separately but connected to a single ground at the reference point of the application board to avoid fluctuations in the small-signal ground caused by large currents. Also ensure that the ground traces of external components do not cause variations on the ground voltage. The ground lines must be as short and thick as possible to reduce line impedance.

### 5. Thermal Consideration

Should by any chance the power dissipation rating be exceeded the rise in temperature of the chip may result in deterioration of the properties of the chip. The absolute maximum rating of the Pd stated in this specification is when the IC is mounted on a 70mm x 70mm x 1.6mm glass epoxy board. In case of exceeding this absolute maximum rating, increase the board size and copper area to prevent exceeding the Pd rating.

### 6. Recommended Operating Conditions

These conditions represent a range within which the expected characteristics of the IC can be approximately obtained. The electrical characteristics are guaranteed under the conditions of each parameter.

### 7. Inrush Current

When power is first supplied to the IC, it is possible that the internal logic may be unstable and inrush current may flow instantaneously due to the internal powering sequence and delays, especially if the IC has more than one power supply. Therefore, give special consideration to power coupling capacitance, power wiring, width of ground wiring, and routing of connections.

### 8. Operation Under Strong Electromagnetic Field

Operating the IC in the presence of a strong electromagnetic field may cause the IC to malfunction.

### 9. Testing on Application Boards

When testing the IC on an application board, connecting a capacitor directly to a low-impedance output pin may subject the IC to stress. Always discharge capacitors completely after each process or step. The IC's power supply should always be turned off completely before connecting or removing it from the test setup during the inspection process. To prevent damage from static discharge, ground the IC during assembly and use similar precautions during transport and storage.

### 10. Inter-pin Short and Mounting Errors

Ensure that the direction and position are correct when mounting the IC on the PCB. Incorrect mounting may result in damaging the IC. Avoid nearby pins being shorted to each other especially to ground, power supply and output pin. Inter-pin shorts could be due to many reasons such as metal particles, water droplets (in very humid environment) and unintentional solder bridge deposited in between pins during assembly to name a few.

**Operational Notes - continued**

**11. Unused Input Pins**

Input pins of an IC are often connected to the gate of a MOS transistor. The gate has extremely high impedance and extremely low capacitance. If left unconnected, the electric field from the outside can easily charge it. The small charge acquired in this way is enough to produce a significant effect on the conduction through the transistor and cause unexpected operation of the IC. So unless otherwise specified, unused input pins should be connected to the power supply or ground line.

**12. Regarding the Input Pin of the IC**

This monolithic IC contains P+ isolation and P substrate layers between adjacent elements in order to keep them isolated. P-N junctions are formed at the intersection of the P layers with the N layers of other elements, creating a parasitic diode or transistor. For example (refer to figure below):

When GND > Pin A and GND > Pin B, the P-N junction operates as a parasitic diode.  
 When GND > Pin B, the P-N junction operates as a parasitic transistor.

Parasitic diodes inevitably occur in the structure of the IC. The operation of parasitic diodes can result in mutual interference among circuits, operational faults, or physical damage. Therefore, conditions that cause these diodes to operate, such as applying a voltage lower than the GND voltage to an input pin (and thus to the P substrate) should be avoided.

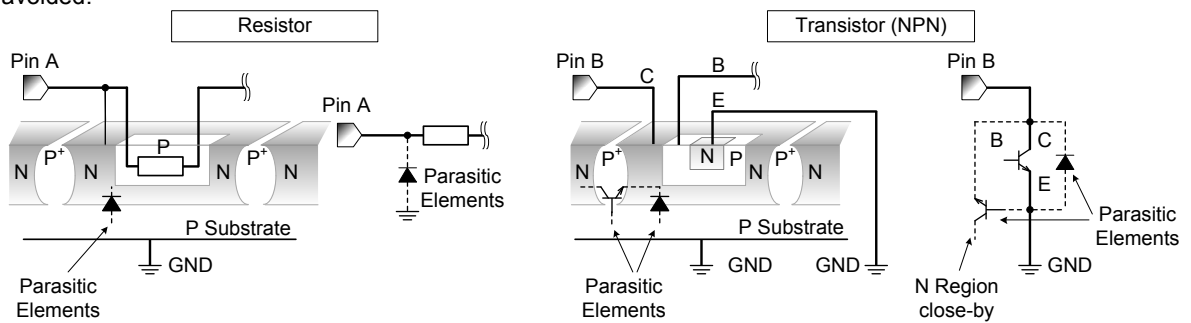

Figure 37. Example of monolithic IC structure

**13. Ceramic Capacitor**

When using a ceramic capacitor, determine the dielectric constant considering the change of capacitance with temperature and the decrease in nominal capacitance due to DC bias and others.

**14. Disturbance light**

In a device where a portion of silicon is exposed to light such as in a WL-CSP, IC characteristics may be affected due to photoelectric effect. For this reason, it is recommended to come up with countermeasures that will prevent the chip from being exposed to light.

Ordering Information

B D 6 5 2 8 H F V	-	T R
Part Number	Package HFV: HVSOF6	Packaging and forming specification TR: Embossed tape and reel (HVSOF6)
B D 6 5 2 9 G U L	-	E 2
Part Number	Package GUL: VCSP50L1	Packaging and forming specification E2: Embossed tape and reel (VCSP50L1)

Marking Diagrams

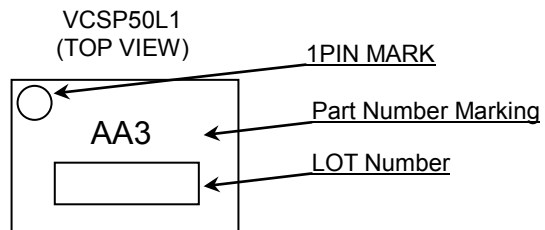
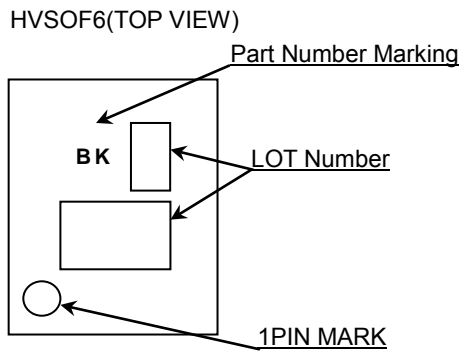

Physical Dimension, Tape and Reel Information

Package Name	HVSOF6
--------------	--------

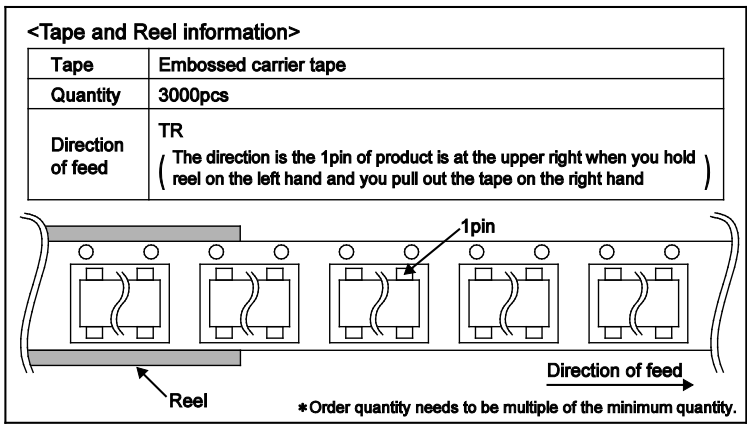
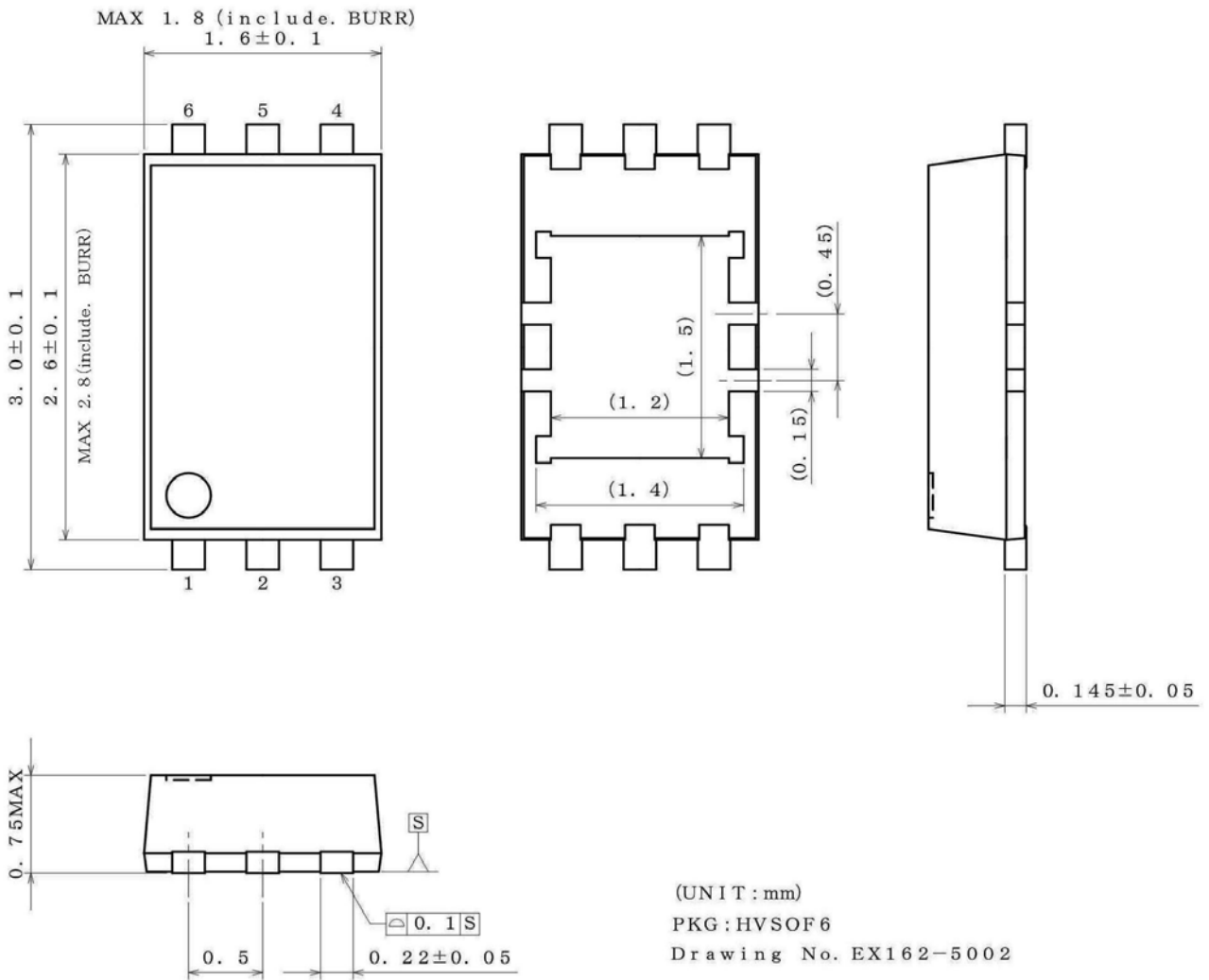

Physical Dimension, Tape and Reel Information – continued

Package Name	VCSP50L1 (BD6529GUL)
--------------	----------------------

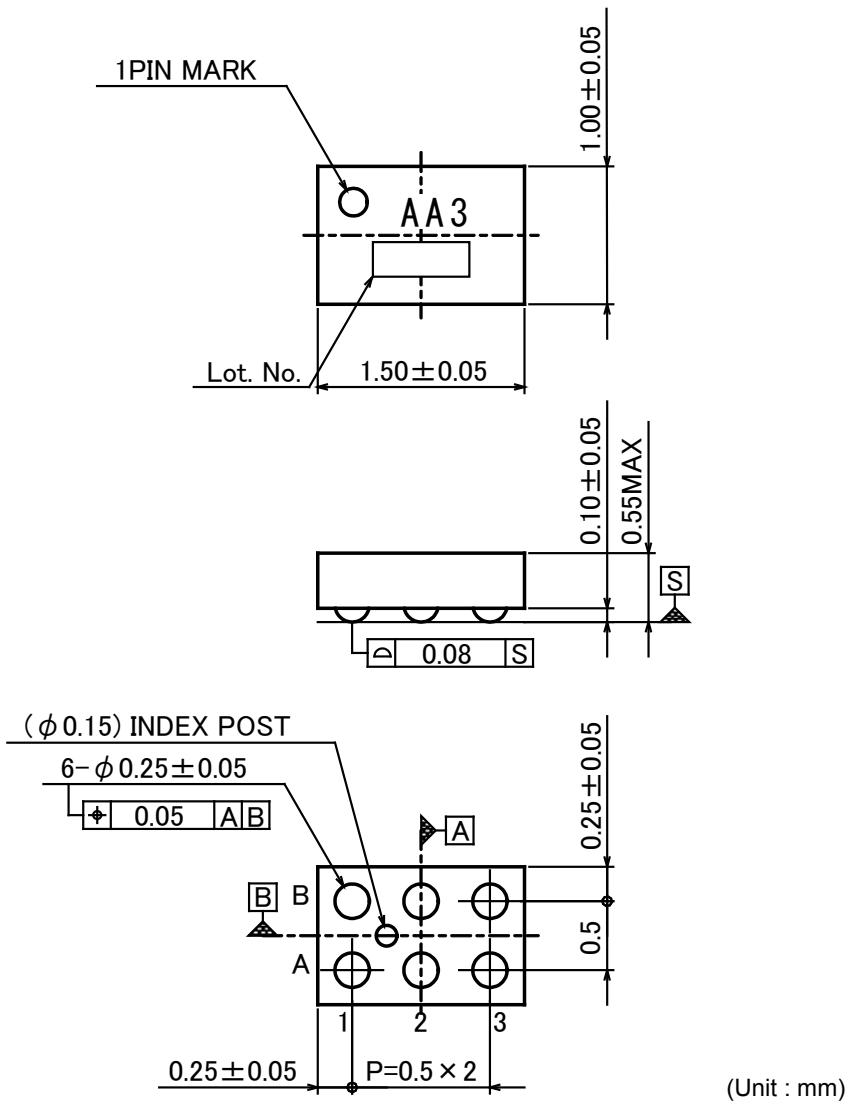

**<Tape and Reel information>**

Tape	Embossed carrier tape (heat sealing method)
Quantity	3000pcs
Direction of feed	E2 (The direction is the 1pin of product is at the upper left when you hold reel on the left hand and you pull out the tape on the right hand)

\*Order quantity needs to be multiple of the minimum quantity.

**Revision History**

Date	Revision	Changes
11.Mar.2013	001	New Release
25.Jun.2013	002	Deleted figures of package on page 1.
21.Aug.2014	003	Applied the ROHM Standard Style and improved understandability.

# Notice

## Precaution on using ROHM Products

- Our Products are designed and manufactured for application in ordinary electronic equipments (such as AV equipment, OA equipment, telecommunication equipment, home electronic appliances, amusement equipment, etc.). If you intend to use our Products in devices requiring extremely high reliability (such as medical equipment <sup>(Note 1)</sup>, transport equipment, traffic equipment, aircraft/spacecraft, nuclear power controllers, fuel controllers, car equipment including car accessories, safety devices, etc.) and whose malfunction or failure may cause loss of human life, bodily injury or serious damage to property ("Specific Applications"), please consult with the ROHM sales representative in advance. Unless otherwise agreed in writing by ROHM in advance, ROHM shall not be in any way responsible or liable for any damages, expenses or losses incurred by you or third parties arising from the use of any ROHM's Products for Specific Applications.

(Note1) Medical Equipment Classification of the Specific Applications

JAPAN	USA	EU	CHINA
CLASS III	CLASS III	CLASS II b	CLASS III
CLASS IV		CLASS III	

- ROHM designs and manufactures its Products subject to strict quality control system. However, semiconductor products can fail or malfunction at a certain rate. Please be sure to implement, at your own responsibilities, adequate safety measures including but not limited to fail-safe design against the physical injury, damage to any property, which a failure or malfunction of our Products may cause. The following are examples of safety measures:
  - Installation of protection circuits or other protective devices to improve system safety
  - Installation of redundant circuits to reduce the impact of single or multiple circuit failure
- Our Products are designed and manufactured for use under standard conditions and not under any special or extraordinary environments or conditions, as exemplified below. Accordingly, ROHM shall not be in any way responsible or liable for any damages, expenses or losses arising from the use of any ROHM's Products under any special or extraordinary environments or conditions. If you intend to use our Products under any special or extraordinary environments or conditions (as exemplified below), your independent verification and confirmation of product performance, reliability, etc. prior to use, must be necessary:
  - Use of our Products in any types of liquid, including water, oils, chemicals, and organic solvents
  - Use of our Products outdoors or in places where the Products are exposed to direct sunlight or dust
  - Use of our Products in places where the Products are exposed to sea wind or corrosive gases, including Cl<sub>2</sub>, H<sub>2</sub>S, NH<sub>3</sub>, SO<sub>2</sub>, and NO<sub>2</sub>
  - Use of our Products in places where the Products are exposed to static electricity or electromagnetic waves
  - Use of our Products in proximity to heat-producing components, plastic cords, or other flammable items
  - Sealing or coating our Products with resin or other coating materials
  - Use of our Products without cleaning residue of flux (even if you use no-clean type fluxes, cleaning residue of flux is recommended); or Washing our Products by using water or water-soluble cleaning agents for cleaning residue after soldering
  - Use of the Products in places subject to dew condensation
- The Products are not subject to radiation-proof design.
- Please verify and confirm characteristics of the final or mounted products in using the Products.
- In particular, if a transient load (a large amount of load applied in a short period of time, such as pulse. is applied, confirmation of performance characteristics after on-board mounting is strongly recommended. Avoid applying power exceeding normal rated power; exceeding the power rating under steady-state loading condition may negatively affect product performance and reliability.
- De-rate Power Dissipation (Pd) depending on Ambient temperature (Ta). When used in sealed area, confirm the actual ambient temperature.
- Confirm that operation temperature is within the specified range described in the product specification.
- ROHM shall not be in any way responsible or liable for failure induced under deviant condition from what is defined in this document.

## Precaution for Mounting / Circuit board design

- When a highly active halogenous (chlorine, bromine, etc.) flux is used, the residue of flux may negatively affect product performance and reliability.
- In principle, the reflow soldering method must be used; if flow soldering method is preferred, please consult with the ROHM representative in advance.

For details, please refer to ROHM Mounting specification

**Precautions Regarding Application Examples and External Circuits**

1. If change is made to the constant of an external circuit, please allow a sufficient margin considering variations of the characteristics of the Products and external components, including transient characteristics, as well as static characteristics.
2. You agree that application notes, reference designs, and associated data and information contained in this document are presented only as guidance for Products use. Therefore, in case you use such information, you are solely responsible for it and you must exercise your own independent verification and judgment in the use of such information contained in this document. ROHM shall not be in any way responsible or liable for any damages, expenses or losses incurred by you or third parties arising from the use of such information.

**Precaution for Electrostatic**

This Product is electrostatic sensitive product, which may be damaged due to electrostatic discharge. Please take proper caution in your manufacturing process and storage so that voltage exceeding the Products maximum rating will not be applied to Products. Please take special care under dry condition (e.g. Grounding of human body / equipment / solder iron, isolation from charged objects, setting of Ionizer, friction prevention and temperature / humidity control).

**Precaution for Storage / Transportation**

1. Product performance and soldered connections may deteriorate if the Products are stored in the places where:
  - [a] the Products are exposed to sea winds or corrosive gases, including Cl<sub>2</sub>, H<sub>2</sub>S, NH<sub>3</sub>, SO<sub>2</sub>, and NO<sub>2</sub>
  - [b] the temperature or humidity exceeds those recommended by ROHM
  - [c] the Products are exposed to direct sunshine or condensation
  - [d] the Products are exposed to high Electrostatic
2. Even under ROHM recommended storage condition, solderability of products out of recommended storage time period may be degraded. It is strongly recommended to confirm solderability before using Products of which storage time is exceeding the recommended storage time period.
3. Store / transport cartons in the correct direction, which is indicated on a carton with a symbol. Otherwise bent leads may occur due to excessive stress applied when dropping of a carton.
4. Use Products within the specified time after opening a humidity barrier bag. Baking is required before using Products of which storage time is exceeding the recommended storage time period.

**Precaution for Product Label**

QR code printed on ROHM Products label is for ROHM's internal use only.

**Precaution for Disposition**

When disposing Products please dispose them properly using an authorized industry waste company.

**Precaution for Foreign Exchange and Foreign Trade act**

Since our Products might fall under controlled goods prescribed by the applicable foreign exchange and foreign trade act, please consult with ROHM representative in case of export.

**Precaution Regarding Intellectual Property Rights**

1. All information and data including but not limited to application example contained in this document is for reference only. ROHM does not warrant that foregoing information or data will not infringe any intellectual property rights or any other rights of any third party regarding such information or data. ROHM shall not be in any way responsible or liable for infringement of any intellectual property rights or other damages arising from use of such information or data.:
2. No license, expressly or implied, is granted hereby under any intellectual property rights or other rights of ROHM or any third parties with respect to the information contained in this document.

**Other Precaution**

1. This document may not be reprinted or reproduced, in whole or in part, without prior written consent of ROHM.
2. The Products may not be disassembled, converted, modified, reproduced or otherwise changed without prior written consent of ROHM.
3. In no event shall you use in any way whatsoever the Products and the related technical information contained in the Products or this document for any military purposes, including but not limited to, the development of mass-destruction weapons.
4. The proper names of companies or products described in this document are trademarks or registered trademarks of ROHM, its affiliated companies or third parties.



**General Precaution**

1. Before you use our Products, you are requested to carefully read this document and fully understand its contents. ROHM shall not be in any way responsible or liable for failure, malfunction or accident arising from the use of any ROHM's Products against warning, caution or note contained in this document.
2. All information contained in this document is current as of the issuing date and subject to change without any prior notice. Before purchasing or using ROHM's Products, please confirm the latest information with a ROHM sales representative.
3. The information contained in this document is provided on an "as is" basis and ROHM does not warrant that all information contained in this document is accurate and/or error-free. ROHM shall not be in any way responsible or liable for any damages, expenses or losses incurred by you or third parties resulting from inaccuracy or errors of or concerning such information.

# Mouser Electronics

Authorized Distributor

Click to View Pricing, Inventory, Delivery & Lifecycle Information:

[ROHM Semiconductor:](#)

[BD6529GUL-E2](#)



Компания «ЭлектроПласт» предлагает заключение долгосрочных отношений при поставках импортных электронных компонентов на взаимовыгодных условиях!

Наши преимущества:

- Оперативные поставки широкого спектра электронных компонентов отечественного и импортного производства напрямую от производителей и с крупнейших мировых складов;
- Поставка более 17-ти миллионов наименований электронных компонентов;
- Поставка сложных, дефицитных, либо снятых с производства позиций;
- Оперативные сроки поставки под заказ (от 5 рабочих дней);
- Экспресс доставка в любую точку России;
- Техническая поддержка проекта, помощь в подборе аналогов, поставка прототипов;
- Система менеджмента качества сертифицирована по Международному стандарту ISO 9001;
- Лицензия ФСБ на осуществление работ с использованием сведений, составляющих государственную тайну;
- Поставка специализированных компонентов (Xilinx, Altera, Analog Devices, Intersil, Interpoint, Microsemi, Aeroflex, Peregrine, Syfer, Eurofarad, Texas Instrument, Miteq, Cobham, E2V, MA-COM, Hittite, Mini-Circuits, General Dynamics и др.);

Помимо этого, одним из направлений компании «ЭлектроПласт» является направление «Источники питания». Мы предлагаем Вам помощь Конструкторского отдела:

- Подбор оптимального решения, техническое обоснование при выборе компонента;
- Подбор аналогов;
- Консультации по применению компонента;
- Поставка образцов и прототипов;
- Техническая поддержка проекта;
- Защита от снятия компонента с производства.



#### Как с нами связаться

**Телефон:** 8 (812) 309 58 32 (многоканальный)

**Факс:** 8 (812) 320-02-42

**Электронная почта:** [org@eplast1.ru](mailto:org@eplast1.ru)

**Адрес:** 198099, г. Санкт-Петербург, ул. Калинина, дом 2, корпус 4, литера А.