

TWM/TWW Series



Ceramic Housed Radial Terminal Power

The TWM/TWW series radial terminal power resistors offer significant board space savings over axial terminal products. Generated heat is also kept away from the circuit board.

They are recommended for commercial applications requiring low cost.



FEATURES

- Economical Commercial Grade for general purpose use
- Wirewound and Metal Oxide construction
- Wide resistance range
- Flameproof inorganic construction

SERIES SPECIFICATIONS

Series	Wattage	Resistance	Voltage	Element
TWW3	3	0.01-39Ω	250	Wire
TWW5	5	0.01-47Ω	350	Wire
TWW10	10	0.04-990Ω	750	Wire
TWW15	15	0.1Ω-560Ω	700	Wire
TWW20	20	0.1Ω-560Ω	750	Wire
TWM3	3	43-50KΩ	250	Metal oxide
TWM5	5	51-50KΩ	350	Metal oxide
TWM10	10	1000-50KΩ	750	Metal oxide
TWM15	15	561Ω-200KΩ	700	Metal oxide
TWM20	20	561Ω-200KΩ	750	Metal oxide

CHARACTERISTICS

Housing	Ceramic
Core	Fiberglass
Filling	Cement based
Tolerance	5% standard
Temperature coefficient	0.01-20Ω ±400ppm/°C; >20-10Ω ±350ppm/°C
Dielectric withstanding voltage	1,000VAC
Short time overload	TWW: 10x rated power for 5 sec.; TWM: 5x rated power for 5 sec. 15 & 20 watt: 2.5x RCWV for 5 sec.
Operating Temperature	-55°C to 275°C
Storage Temperature	15°C-35°C, humidity: 25%-75%

Derating



(continued)

TWM/TWW Series

Ceramic Housed Radial Terminal Power

DIMENSIONS

3-10 watt Series	Height (in./mm) ±1mm	Width (in./mm) ±1mm
TWW3	0.98 / 25	0.33 / 8.5
TWW5	0.98 / 25	0.35 / 9
TWM10	1.97 / 50	0.35 / 9
TWM3	0.98 / 25	0.33 / 8.5
TWM5	0.98 / 25	0.35 / 9
TWM10	1.97 / 50	0.35 / 9

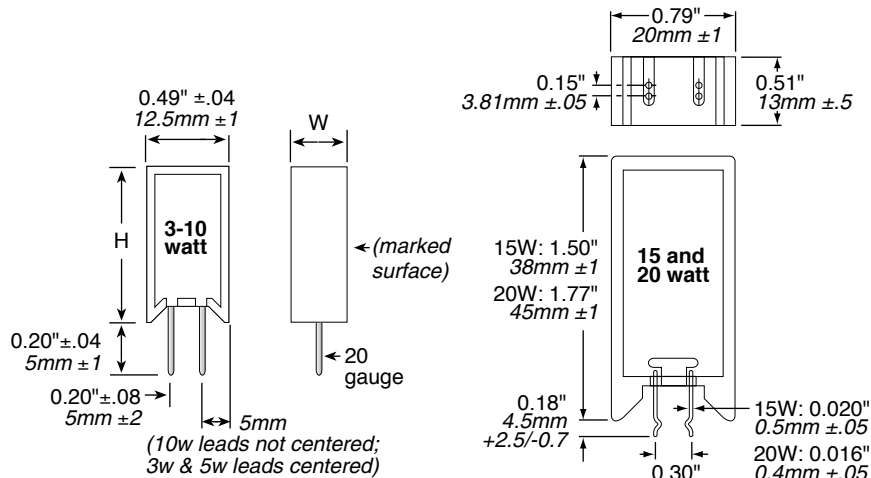

HOW TO ORDER



Standard part numbers for TWW series

Ohmic value	Wattage					Ohmic value	Wattage					Ohmic value	Wattage						
	Part No. Prefix Suffix	3	5	10	15		20	Part No. Prefix Suffix	3	5	10		15	20	Part No. Prefix Suffix	3	5	10	15
0.01	R01E	✓	✓			2.0	R0E	✓	✓	✓		47	R7E	✓	✓	✓			
0.02	R02E	✓	✓			2.7	R7E	✓	✓	✓	✓	51	R1E	✓	✓	✓			✓
0.03	R03E	✓	✓			3.0	R0E	✓	✓	✓		56	R6E	✓	✓	✓			
0.04	R04E	✓	✓	✓		3.3	R3E	✓	✓	✓		68	R8E	✓	✓	✓			
0.05	R05E	✓	✓	✓		3.9	R9E	✓	✓	✓		75	R5E	✓	✓	✓			✓
0.10	R10E	✓	✓	✓	✓	4.3	R3E	✓	✓	✓		82	R2E	✓	✓	✓			
0.15	R15E	✓	✓	✓	✓	4.7	R7E	✓	✓	✓		100	R0E	✓	✓	✓			✓
0.20	R20E	✓	✓	✓	✓	5.6	R6E	✓	✓	✓		150	R5E	✓	✓	✓			✓
0.27	R27E	✓	✓	✓	✓	6.8	R8E	✓	✓	✓		200	R0E	✓	✓	✓			✓
0.30	R30E	✓	✓	✓	✓	7.5	R5E	✓	✓	✓		270	R7E	✓	✓	✓			✓
0.33	R33E	✓	✓	✓	✓	8.2	R2E	✓	✓	✓		300	R0E	✓	✓	✓			
0.39	R39E	✓	✓	✓	✓	10	R0E	✓	✓	✓		330	R3E	✓	✓	✓			
0.43	R43E	✓	✓	✓	✓	15	R5E	✓	✓	✓		390	R9E	✓	✓	✓			
0.47	R47E	✓	✓	✓	✓	20	R0E	✓	✓	✓		430	R3E	✓	✓	✓			
0.56	R56E	✓	✓	✓	✓	22	R2E	✓	✓	✓		470	R7E	✓	✓	✓			
0.68	R68E	✓	✓	✓	✓	27	R7E	✓	✓	✓		500	R0E	✓	✓	✓			✓
0.75	R75E	✓	✓	✓	✓	30	R0E	✓	✓	✓		560	R6E	✓	✓	✓			
0.82	R82E	✓	✓	✓	✓	33	R3E	✓	✓	✓		680	R8E	✓	✓	✓			
1.0	R10E	✓	✓	✓	✓	39	R9E	✓	✓	✓		750	R5E	✓	✓	✓			
1.5	R15E	✓	✓	✓	✓	43	R3E	✓	✓	✓		820	R2E	✓	✓	✓			

Standard part numbers for TWM series

Ohmic value	Wattage		Ohmic value	Wattage		Ohmic value	Wattage		Ohmic value	Wattage				
	Part No. Prefix Suffix	3		5	Part No. Prefix Suffix		3	5		Part No. Prefix Suffix	3	5	Part No. Prefix Suffix	3
43	R3E	✓	1000	R1K0	✓	47	R7E	✓	1500	R1K5	✓			
47	R7E	✓	1500	R1K5	✓	56	R6E	✓	2000	R2K0	✓			
56	R6E	✓	2000	R2K0	✓	68	R8E	✓	2700	R2K7	✓			
68	R8E	✓	2700	R2K7	✓	75	R5E	✓	3000	R3K0	✓			
75	R5E	✓	3000	R3K0	✓	82	R2E	✓	3300	R3K3	✓			
82	R2E	✓	3300	R3K3	✓	100	R0E	✓	3900	R3K9	✓			
100	R0E	✓	3900	R3K9	✓	150	R5E	✓	4300	R4K3	✓			
150	R5E	✓	4300	R4K3	✓	200	R0E	✓	4700	R4K7	✓			
200	R0E	✓	4700	R4K7	✓	270	R7E	✓	5600	R5K6	✓			
270	R7E	✓	5600	R5K6	✓	300	R0E	✓	5100	R5K1	✓			
300	R0E	✓	5100	R5K1	✓	330	R3E	✓	6800	R6K8	✓			
330	R3E	✓	6800	R6K8	✓	390	R9E	✓	7500	R7K5	✓			
390	R9E	✓	7500	R7K5	✓	430	R3E	✓	8200	R8K2	✓			
430	R3E	✓	8200	R8K2	✓	470	R7E	✓	10000	R10K	✓			
470	R7E	✓	10000	R10K	✓	560	R6E	✓	27000	R27K	✓			
560	R6E	✓	27000	R27K	✓	680	R8E	✓	47000	R47K	✓			
680	R8E	✓	47000	R47K	✓	750	R5E	✓	51000	R51K	✓			
750	R5E	✓	51000	R51K	✓	820	R2E	✓	75000	R75K	✓			
820	R2E	✓	75000	R75K	✓									



Компания «ЭлектроПласт» предлагает заключение долгосрочных отношений при поставках импортных электронных компонентов на взаимовыгодных условиях!

Наши преимущества:

- Оперативные поставки широкого спектра электронных компонентов отечественного и импортного производства напрямую от производителей и с крупнейших мировых складов;
- Поставка более 17-ти миллионов наименований электронных компонентов;
- Поставка сложных, дефицитных, либо снятых с производства позиций;
- Оперативные сроки поставки под заказ (от 5 рабочих дней);
- Экспресс доставка в любую точку России;
- Техническая поддержка проекта, помощь в подборе аналогов, поставка прототипов;
- Система менеджмента качества сертифицирована по Международному стандарту ISO 9001;
- Лицензия ФСБ на осуществление работ с использованием сведений, составляющих государственную тайну;
- Поставка специализированных компонентов (Xilinx, Altera, Analog Devices, Intersil, Interpoint, Microsemi, Aeroflex, Peregrine, Syfer, Eurofarad, Texas Instrument, Miteq, Cobham, E2V, MA-COM, Hittite, Mini-Circuits, General Dynamics и др.);

Помимо этого, одним из направлений компании «ЭлектроПласт» является направление «Источники питания». Мы предлагаем Вам помощь Конструкторского отдела:

- Подбор оптимального решения, техническое обоснование при выборе компонента;
- Подбор аналогов;
- Консультации по применению компонента;
- Поставка образцов и прототипов;
- Техническая поддержка проекта;
- Защита от снятия компонента с производства.



Как с нами связаться

Телефон: 8 (812) 309 58 32 (многоканальный)

Факс: 8 (812) 320-02-42

Электронная почта: org@eplast1.ru

Адрес: 198099, г. Санкт-Петербург, ул. Калинина, дом 2, корпус 4, литера А.