

# Highly compact signal conditioners

with plug-in connection technology

## MINI Analog Pro

# Easier than ever but as slim as before

MINI Analog Pro offers the easiest installation and startup with minimum space requirements. MINI Analog Pro is the first 6 mm signal conditioner range with plug-in connection technology. Easily accessible terminal points and current measurement during operation make your work easier than ever.

## Your advantages

- Easy installation, thanks to easily accessible terminal points, power bridging, and plug-in connection terminal blocks
- Measure current signals during operation, without disconnecting current loops
- Set parameters in a versatile way: via DIP switch, software or a MINI Analog Pro app
- Easy to maintain, thanks to large-surface marking areas, status LEDs, and group error messaging
- Optimum signal quality, thanks to the latest in switching technology and safe electrical isolation
- Suitable for all applications: from cost-effective standard signal conditioners right through to multifunctional device types

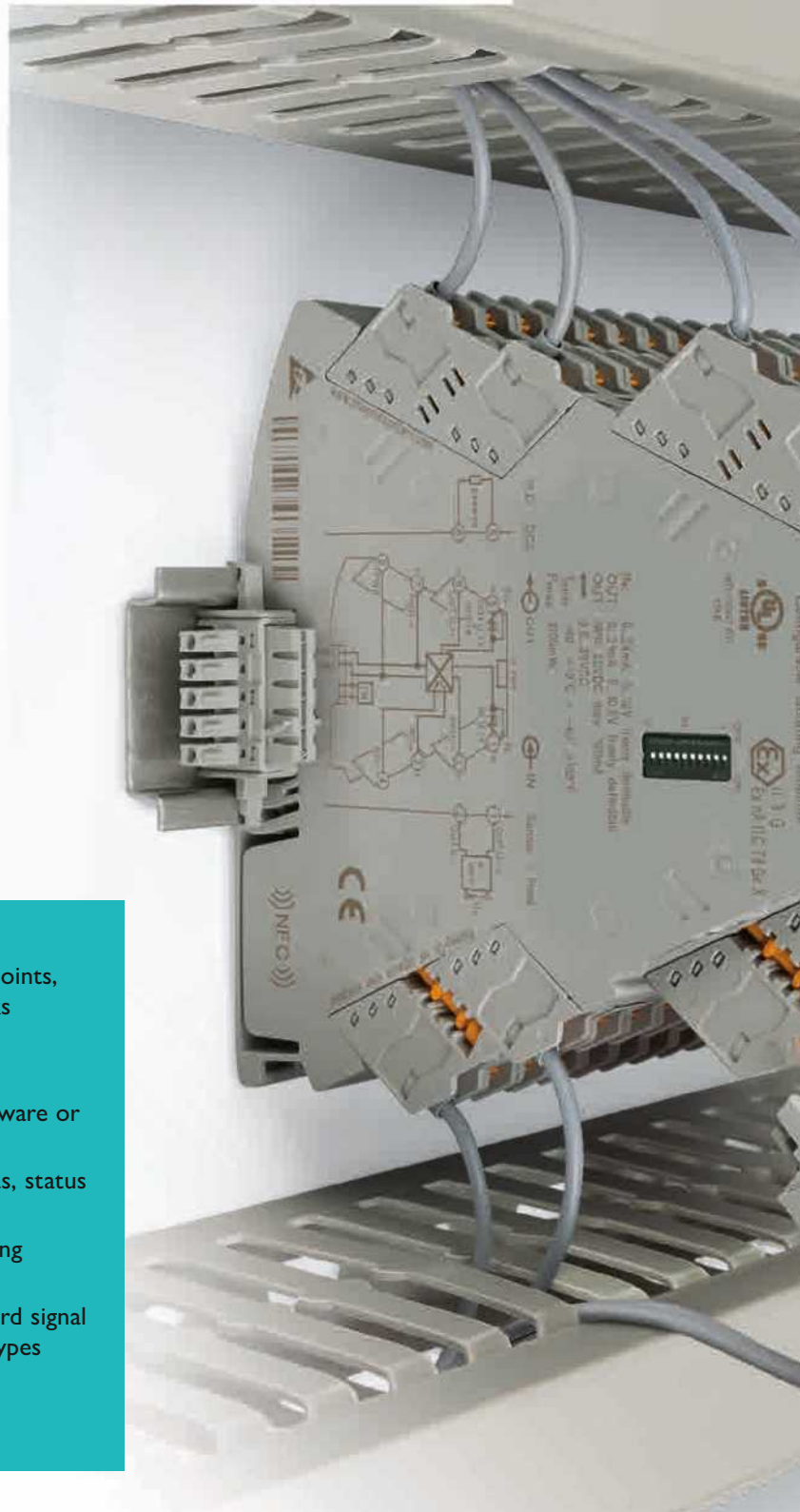



## Push-in Technology

Designed by PHOENIX CONTACT

### Unique in the 6 mm class

FASTCON Pro plug-in connection terminal blocks: with either screw or push-in connection technology.

## MINI Analog Pro product overview

### Analog IN/Analog OUT

- Universal signal conditioners
- Standard signal conditioners
- Repeater power supplies
- Passive isolators

Page 10 – 11

### Temperature

- Universal temperature transducers for resistance thermometers and thermocouples

Page 12

### Frequency

- Universal analog frequency measuring transducers

Page 12

### Potentiometers

- Potiposition transducers with automatic potentiometer detection

Page 12

### Digital IN

- Signal conditioners for NAMUR sensors and floating contacts

Page 12

### Limit values

- Limit value switch with relay PDT output

Page 12

### Accessories

- Constant voltage/constant current source
- Supply components
- Fault monitoring module
- Marking material
- Set consisting of current transformer for retrofitting, Rogowski coil, and measuring transducer

Page 13–14

### Universal use

thanks to international approval package:





# The easiest installation and startup in a confined space

The design with frontal connection and operating elements saves space between the cable ducts. Even in the smallest spaces, the conductors can be fed in, in any sequence, regardless of whether they begin with wiring at the point of input, output or supply.

## Now it's within your reach

All connection and operating elements are easy to access and view from the front.

Further information on  
MINI Analog Pro:  
Simply type a web code into the  
search field on our website.

 Web code: #0492

## Your advantages with MINI Analog Pro



### Easy installation

The FASTCON Pro connection terminal blocks can even be inserted and removed independently as part of a device network. The robust direct insertion ensures that the contact quality remains consistently high, even after frequent use.



### Fast power bridging and group error messaging

Easy power bridging with the DIN rail connector simplifies wiring, system extension or module replacement during operation. In addition, benefit from group error messaging in multi-channel applications.



### Measure current signals during operation

Measure current signals during operation and integrate your current measuring device into the signal circuit, without having to disconnect it. With just one measurement, you can record the entire current loop, from the sensor to the controller.

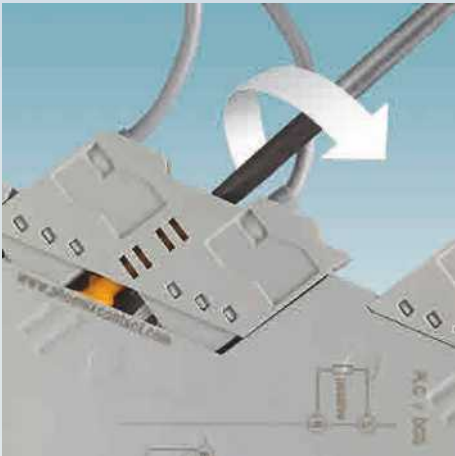

### Easy startup and service

Interrupt the signal and supply circuit in the event of service and startup in no time at all, by setting the FASTCON Pro connection terminal blocks to the disconnect position. The wiring remains the same.



### Easy maintenance

Large-surface marking areas enable full loops to be marked with standard marking material, despite the compact design. All status and error displays are constantly visible and provide you with an instant overview on site.

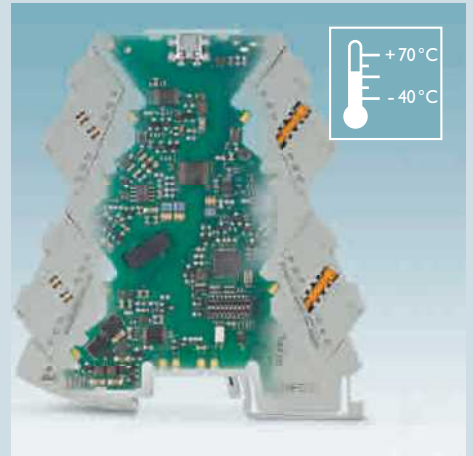

### Optimum signal quality for every application

The latest transmission technology and safe electrical isolation with 3 kV test voltage ensure optimum signal quality, even under extreme temperatures. Multifunctional product types and a supply of 9.6 to 30 V enable flexible use.

# Always the right product for your signal processing

MINI Analog Pro offers you the right product for all standard signal processing applications: from cost-effective standard signal conditions with fixed functions right through to freely configurable universal signal conditioners with as many signal combinations as necessary.

0 ... 2,5 V  
0 ... 10 V  
2 ... 7 V  
3 ... 10 V  
0 ... 5 mA  
4 ... 20 mA  
7 ... 18 mA  
10 ... 20 mA

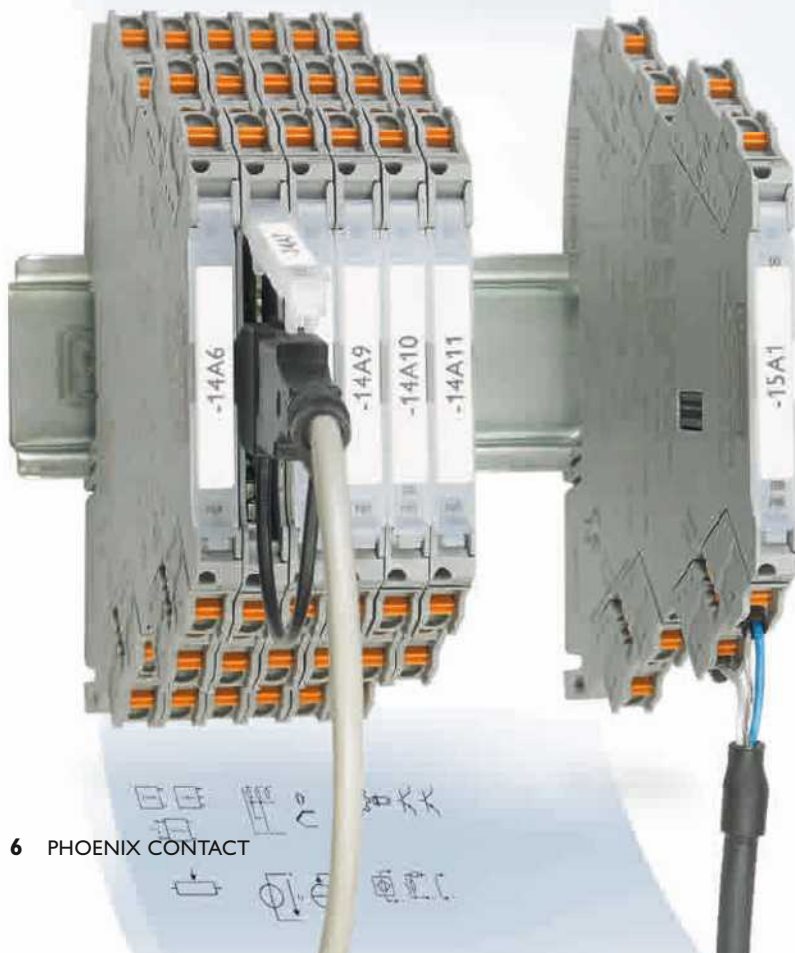

## Convert high currents into analog standard signals

Thanks to the two-part PACT RCP-4000A-UIRO measuring system, you can convert alternating currents of up to 4000 A directly into the widest range of analog standard signals. Install the handy Rogowski coil easily on busbars and round conductors, without having to disassemble system parts. The downstream measuring transducer can be freely configured both at the signal input as well as the signal output.



## Numerous parameterization options



### Easy standard configuration without additional adjustment

The standard functions can be easily adjusted via DIP switch. The calibrated measuring range switchover guarantees consistent accuracy without additional adjustment.

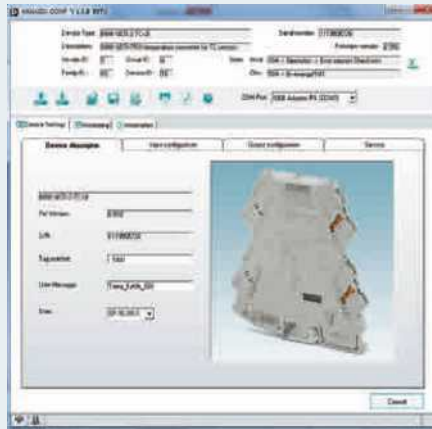

### Extended configuration and monitoring via PC

For extended functionality, you can easily configure the multifunctional modules from your PC with standalone software or via FDT/DTM. In addition, you can monitor your process data using the monitoring function.



### Information and configuration irrespective of location

All MINI Analog Pro modules have an NFC interface for wireless communication with your Android smartphone. Without any need for accessories, benefit from the many functionalities of the MINI Analog Pro app and configure the modules directly on site, for example in the event of servicing.



### Smart configuration and monitoring with the MINI Analog Pro app

Download the free MINI Analog Pro app to your smartphone or tablet. Depending on the mobile terminal device and product type, the application offers various functionalities:

- 1) Calling module information
- 2) Calling DIP switch setting help
- 3) Configuration of the multifunctional modules
  - Via NFC with your Android device, without any need for further accessories
  - Via Bluetooth with your Android or iOS device and the Bluetooth adapter
- 4) Monitoring and optimization of process data in the multifunctional modules
  - Via Bluetooth with your Android or iOS device and the Bluetooth adapter



Thanks to the Bluetooth adapter, you can communicate conveniently with the multifunctional modules using your Android or iOS device



### State-of-the-art switching technology

#### Flexible supply

The extended supply voltage range from 9.6 V DC to 30 V DC ensures a high level of availability and enables flexible use, for example in 12 V applications.

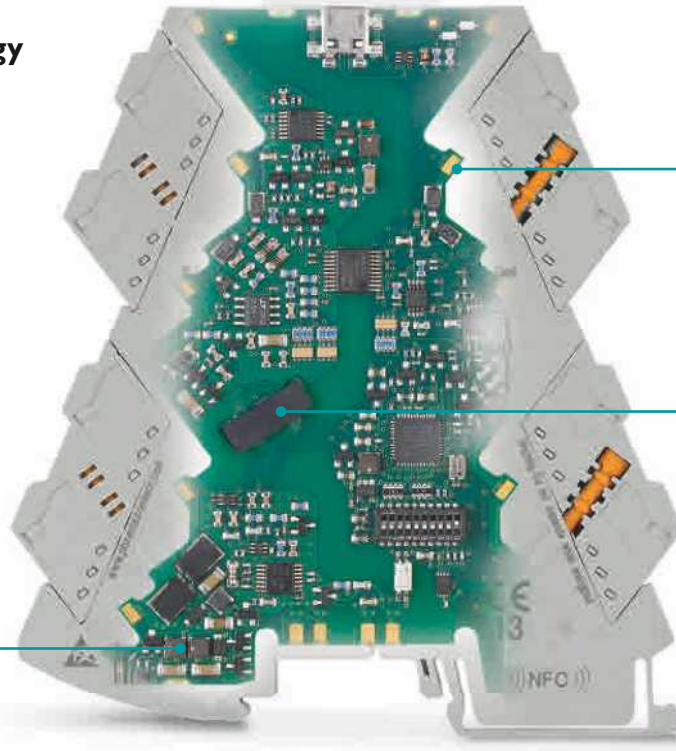

#### High contact quality

The connection terminal blocks make contact by means of robust direct insertion. There are no metal pins that can be damaged.

#### Safe electrical isolation

MINI Analog offers the latest transmission technology and safe electrical isolation between the input, output, and supply, with 3 kV test voltage.

#### Hot, cold? No problem.

The wide operating temperature range from -40°C to +70°C enables use even under extreme ambient conditions.

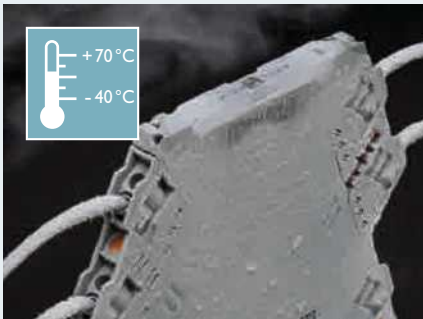

*MINI Analog Pro signal conditioners function safely and reliably even at -40°C*

#### Quality from a single source – made in Germany

It is only when the smallest details are taken into account that you can be sure the quality is right. For this reason, we develop and manufacture all the components for the MINI Analog Pro ourselves. In our own plastic, metal



*Modern production processes ensure high quality and short delivery times*

part, and SMD manufacturing plants, we produce high-quality signal conditioners that are “made in Germany”. Yet another advantage: short deliver times, even when ordering large quantities.





## Flexible and simple power supply

Easy power bridging with the DIN rail connector simplifies wiring, system extension or even module replacement during operation.

The DIN rail connector gives you three device supply options:

- 1) Direct DC supply to any MINI Analog Pro module:
  - For up to 16 MINI Analog Pro modules
  - No additional accessories required other than the DIN rail connector
- 2) Via a supply module with the same shape:
  - For up to 115 MINI Analog Pro modules
  - Also allows redundant supply and supply monitoring
- 3) Via the system power supply with wide range input from 85 V AC right through to 264 V AC:
  - When a DC supply is not available
  - For up to 60 MINI Analog Pro modules

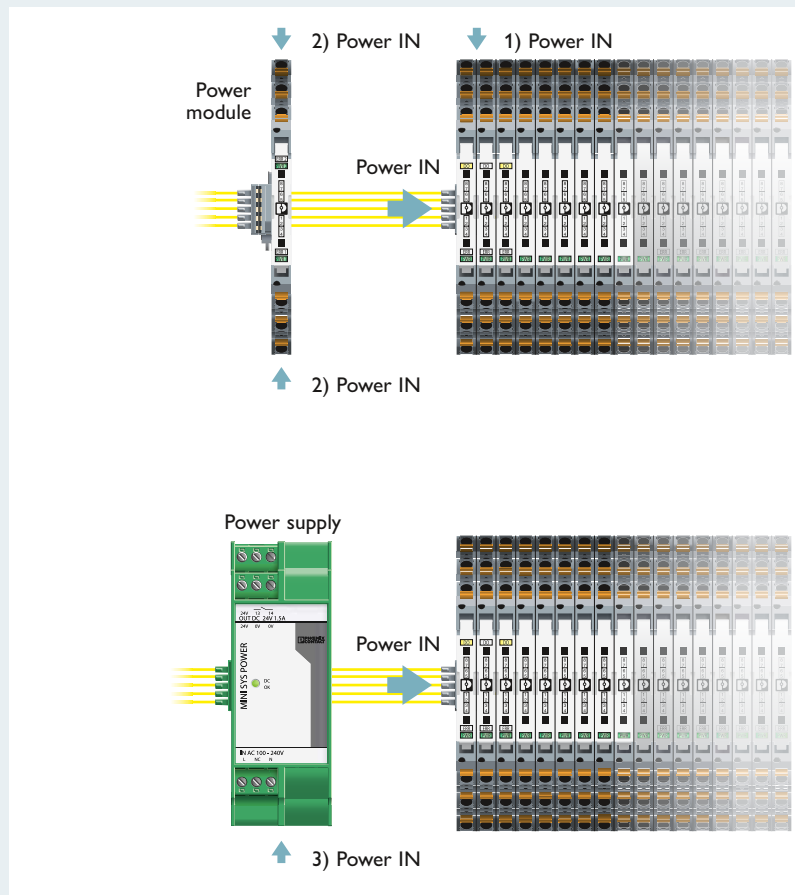

## Convenient error evaluation with fault monitoring

Fault monitoring is a modular solution for convenient error evaluation in multi-channel applications. Depending on the module type, the following errors can be indicated by means of a group error message:

- Measuring range overshoot
- Measuring range undershot
- Open circuit
- Short circuit
- Module error

It is also possible to detect and indicate the failure of a supply voltage at the power terminal. The modularity is distinguished by the error evaluation which can be freely adjusted, both on the device side and in the evaluation module.

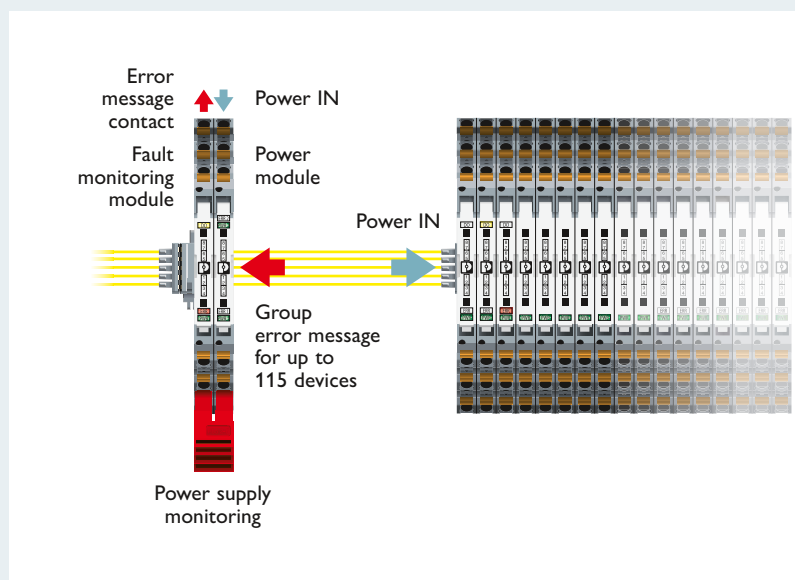

## MINI Analog Pro product overview

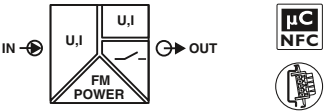
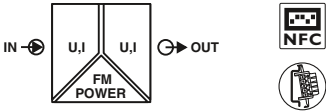
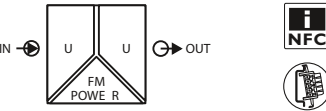
	Analog IN/Analog OUT	Analog IN/Analog OUT	Analog IN/Analog OUT
	 <p>Universal 4-way signal conditioner with relay contact, configurable</p>	 <p>3-way signal conditioner, configurable</p>	 <p>3-way signal conditioner, with fixed signal combinations</p>
<b>IN</b>	<p>0 ... 24 mA (can be set freely)                      0 ... 12 V (can be set freely)                      Can be set via DIP switch, software or app</p>	<p>0 ... 20 mA, 4...20 mA, -20...20 mA,                      0 ... 5 V, 1 ... 5 V, -5 ... 5 V,                      0 ... 10 V, 2 ... 10 V, -10 ... 10 V,                      0 ... 20 V, 4 ... 20 V, -20 ... 20 V,                      0 ... 24 V, 4.8 ... 24 V, -24 ... 24 V,                      0 ... 30 V, 6 ... 30 V, -30 ... 30 V                      Can be set via DIP switch</p>	<p>0 ... 20 mA, 4 ... 20 mA; IN = OUT</p>
<b>OUT</b>	<p>0 ... 21 mA (can be set freely),                      0 ... 10.5 V (can be set freely)                      With fault signaling                      Supports fault monitoring                      Can be set via DIP switch, software or app</p>	<p>0 ... 20 mA, 4 ... 20 mA,                      0 ... 5 V, 1 ... 5 V, -5 ... 5 V,                      0 ... 10 V, 2 ... 10 V, -10 ... 10 V                      Supports fault monitoring                      Can be set via DIP switch</p>	<p>0 ... 20 mA, 4 ... 20 mA; IN = OUT                      Supports fault monitoring</p>
<b>Screw connection</b>	<b>MINI MCR-2-UNI-UI-UIRO*)</b> 2902026	<b>MINI MCR-2-UI-UI*)</b> 2902037	<b>MINI MCR-2-I-I</b> 2901998
<b>Push-in connection</b>	<b>MINI MCR-2-UNI-UI-UIRO-PT*)</b> 2902028	<b>MINI MCR-2-UI-UI-PT*)</b> 2902040	<b>MINI MCR-2-I-I-PT</b> 2901999

	Analog IN/Analog OUT	Analog IN/Analog OUT	Analog IN/Analog OUT
	 <p>3-way signal conditioner, with fixed signal combinations</p>	 <p>3-way signal conditioner, with fixed signal combinations</p>	 <p>3-way signal conditioner, with fixed signal combinations</p>
<b>IN</b>	<p>0 ... 10 V, -10 ... 10 V; IN = OUT</p>	<p>0 ... 10 V</p>	<p>0 ... 10 V</p>
<b>OUT</b>	<p>0 ... 10 V, -10 ... 10 V; IN = OUT                      Supports fault monitoring</p>	<p>0 ... 20 mA                      Supports fault monitoring</p>	<p>4 ... 20 mA                      Supports fault monitoring</p>
<b>Screw connection</b>	<b>MINI MCR-2-U-U</b> 2902042	<b>MINI MCR-2-U-I0</b> 2902022	<b>MINI MCR-2-U-I4</b> 2902029
<b>Push-in connection</b>	<b>MINI MCR-2-U-U-PT</b> 2902043	<b>MINI MCR-2-U-I0-PT</b> 2902023	<b>MINI MCR-2-U-I4-PT</b> 2902030

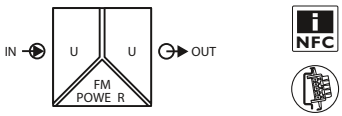
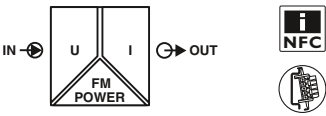
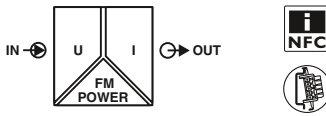
\*) Versions can also be ordered pre-configured ex-works



The module can be snapped onto the DIN rail connector.

# MINI Analog Pro product overview

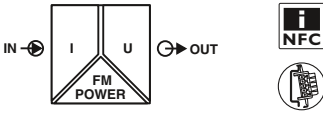
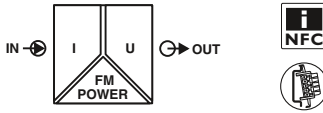
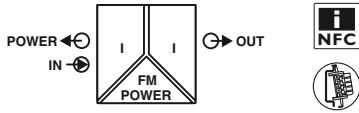
	Analog IN/Analog OUT	Analog IN/Analog OUT	Analog IN/Analog OUT
	 <p>3-way signal conditioner, with fixed signal combinations</p>	 <p>3-way signal conditioner, with fixed signal combinations</p>	 <p>Repeater power supply, HART-transparent</p>
<b>IN</b>	0 ... 20 mA	4 ... 20 mA	Isolator operation: 0 ... 20 mA, 4 ... 20 mA; IN = OUT Repeater power supply operation 4 ... 20 mA; IN = OUT
<b>OUT</b>	0 ... 10 V Supports fault monitoring	0 ... 10 V Supports fault monitoring	0 ... 20 mA, 4 ... 20 mA; IN = OUT Supports fault monitoring
<b>Screw connection</b>	<b>MINI MCR-2-I0-U</b> 2902000	<b>MINI MCR-2-I4-U</b> 2902002	<b>MINI MCR-2-RPSS-I-I</b> 2902014
<b>Push-in connection</b>	<b>MINI MCR-2-I0-U-PT</b> 2902001	<b>MINI MCR-2-I4-U-PT</b> 2902003	<b>MINI MCR-2-RPSS-I-I-PT</b> 2902015

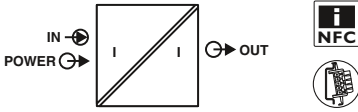
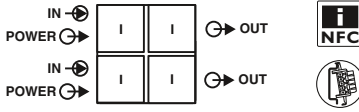
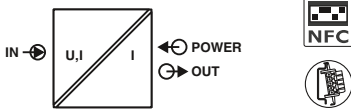
	Analog IN/Analog OUT	Analog IN/Analog OUT	Analog IN/Analog OUT
	 <p>Input loop-powered 2-way isolator, 1-channel</p>	 <p>Input loop-powered 2-way isolator, 2-channel</p>	 <p>Output loop-powered 2-way isolator</p>
<b>IN</b>	0 ... 20 mA, 4 ... 20 mA; IN = OUT	2 x 0 ... 20 mA, 4 ... 20 mA; IN = OUT	0 ... 2 mA up to 0 ... 40 mA (16 ranges) Unipolar and bipolar: 0 ... 50 mV up to 0 ... 30 V (58 ranges) Can be set via DIP switch
<b>OUT</b>	0 ... 20 mA, 4 ... 20 mA; IN = OUT	2 x 0 ... 20 mA, 4 ... 20 mA; IN = OUT	4 ... 20 mA
<b>Screw connection</b>	<b>MINI MCR-2-I-I-ILP</b> 2901994	<b>MINI MCR-2-2I-2I-ILP</b> 2901996	<b>MINI MCR-2-UI-I-OLP</b> 2902061
<b>Push-in connection</b>	<b>MINI MCR-2-I-I-ILP-PT</b> 2901995	<b>MINI MCR-2-2I-2I-ILP-PT</b> 2901997	<b>MINI MCR-2-UI-I-OLP-PT</b> 2902063

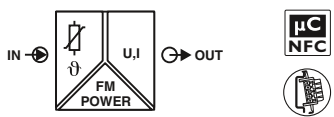
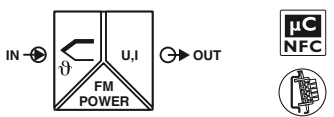
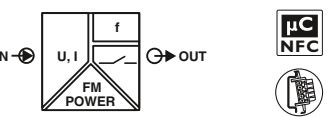

## MINI Analog Pro product overview

	Temperature	Temperature	Frequency
	 <p>Universal measuring transducer for resistance thermometers, configurable</p>	 <p>Universal measuring transducer for thermocouples, configurable</p>	 <p>Analog frequency transducer/limit value switch, configurable</p>
<b>IN</b>	2-, 3- or 4-wire IEC 751: Pt100, Pt200, Pt500, Pt1000 GOST 6651-2009: Pt100, Pt1000, Cu50, Cu100, Cu53 JIS C1604-1997: Pt100, Pt1000 DIN 43760: Ni100, Ni1000 -200°C...+850°C (depending on the sensor) Linear resistance: 0...4 kΩ Can be set via DIP switch, software or app	IEC 584-1: B, E, J, K, N, R, S, T DIN 43710: L, U GOST 8.585: A-1, A-2, A-3, M, L -250°C...+2500°C (depending on the sensor) Can be set via DIP switch, software or app	0...24 mA (can be set freely), 0...12 V (can be set freely) Can be set via DIP switch, software or app
<b>OUT</b>	0...21 mA (can be set freely), 0...10.5 V (can be set freely) With fault signaling Supports fault monitoring Can be set via DIP switch, software or app	0...21 mA (can be set freely), 0...10.5 V (can be set freely) With fault signaling Supports fault monitoring Can be set via DIP switch, software or app	Frequency output: 0...10 kHz (can be set freely) PWM output: 0...100% Switching output: 1 N/O contact transistor output (F/PWM output can also be used as a second switching output) Can be set via DIP switch, software or app
<b>Screw connection</b>	<b>MINI MCR-2-RTD-UI *</b> 2902049	<b>MINI MCR-2-TC-UI *</b> 2902055	<b>MINI MCR-2-UI-FRO *</b> 2902031
<b>Push-in connection</b>	<b>MINI MCR-2-RTD-UI-PT *</b> 2902052	<b>MINI MCR-2-TC-UI-PT *</b> 2905249	<b>MINI MCR-2-UI-FRO-PT *</b> 2902032

	Potentiometer	Digital IN	Limit values
	 <p>Potentiometer measuring transducer, configurable</p>	 <p>NAMUR signal conditioner, configurable</p>	 <p>Limit value switch, configurable</p>
<b>IN</b>	3-wire potentiometer 100 Ω...100 kΩ Automatic detection Can be set via DIP switch, software or app	NAMUR proximity sensors Floating switch contacts Switch contacts with resistance circuit Can be set via DIP switch	0...24 mA (can be set freely) 0...12 V (can be set freely) Can be set via DIP switch, software or app
<b>OUT</b>	0...21 mA (can be set freely) 0...10.5 V (can be set freely) With fault signaling Supports fault monitoring Can be set via DIP switch, software or app	2 N/O contact transistor outputs 1 output, can be used either for signal duplication or error messaging Can be set via DIP switch	1 PDT relay Switching threshold can be set via DIP switch, software or app
<b>Screw connection</b>	<b>MINI MCR-2-POT-UI *</b> 2902016	<b>MINI MCR-2-NAM-2RO</b> 2902004	<b>MINI MCR-2-UI-REL *</b> 2902033
<b>Push-in connection</b>	<b>MINI MCR-2-POT-UI-PT *</b> 2902017	<b>MINI MCR-2-NAM-2RO-PT</b> 2902005	<b>MINI MCR-2-UI-REL-PT *</b> 2902035

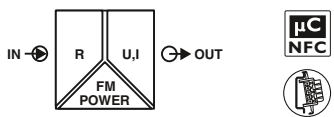
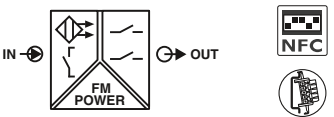
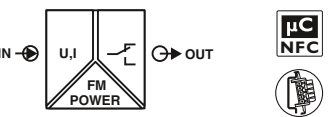
<sup>\*)</sup> Versions can also be ordered pre-configured ex-works



The module can be snapped onto the DIN rail connector.

# MINI Analog Pro product overview

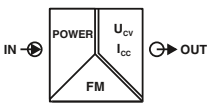
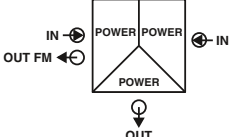
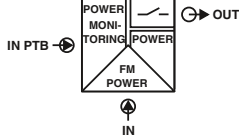
	Accessories	Accessories	Accessories
	 Constant voltage/constant current source	 Power terminal	 Fault monitoring module
<b>Description</b>	Constant voltage/constant current source for potentiometers, measuring bridges, encoders, etc. Input: 9.6...30 V DC Output: 10 V / 8.75 V / 7.5 V / 6.25 V / 5 V / 3.75 V / 2.5 V / 1.25 V / 20 mA / 17.5 mA / 15 mA / 12.5 mA / 10 mA / 7.5 mA / 5 mA / 2.5 mA Can be set via DIP switch	For redundant supply on the DIN rail connector Inputs: 9.9 ... 30 V DC Output: max. 3.2 A; 9.6 ... 29.7 V DC Monitoring of the supply possible in combination with fault monitoring	Fault monitoring module for evaluation and group error messaging in the fault monitoring system Monitoring of supply voltages of MINI MCR-2-PTB(-PT) power terminals
<b>Screw connection</b>	<b>MINI MCR-2-CVCS</b> 2902064	<b>MINI MCR-2-PTB</b> 2902066	<b>MINI MCR-2-FM-RC</b> 2904504
<b>Push-in connection</b>	<b>MINI MCR-2-CVCS-PT</b> 2902065	<b>MINI MCR-2-PTB-PT</b> 2902067	<b>MINI MCR-2-FM-RC-PT</b> 2904508

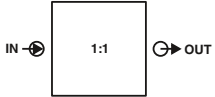
	Accessories
	 Feed-through terminal block 1:1 connection
<b>Description</b>	Feed-through terminal block for 1:1 forwarding of signals that are already electrically isolated in the MINI Analog Pro group
<b>Screw connection</b>	<b>MINI MCR-2-TB</b> 2902068
<b>Push-in connection</b>	



## Order configuration

Order your desired device configuration easily and flexibly:

- Use the order key from the catalog
- User-guided e-shop

[www.phoenixcontact.net/products](http://www.phoenixcontact.net/products)

## Accessories for MINI Analog Pro



### DIN rail connector

#### ME 6,2 TBUS-2 1,5/5-ST-3,81 GY

Order No.: 2695439

- Gray, for two MINI Analog Pro modules each

#### ME 17,5 TBUS 1,5/5-ST-3,81 GN

Order No.: 2709561

- Green, for MINI-SYS system power supply (2 required)



### System power supply

#### MINI-SYS-PS-100-240AC/24DC/1.5

Order No.: 2866983

#### MINI-PS-100-240AC/24DC/1.5/EX

Order No. 2866653 (Ex n-capable)

- Wide range input: 85 ... 264 V AC (45 – 65 Hz)
- Output voltage: 24 V DC  $\pm$  1%
- Output current: 1.5 A at 60°C/2 A at 40°C



### Programming adapter

#### IFS-USB-PROG-ADAPTER

Order No.: 2811271

- Programming adapter with USB interface, for programming via PC

#### NFC-USB-PROG-ADAPTER

Order No.: 2900013

- Programming adapter for wireless communication via NFC

#### IFS-BT-PROG-ADAPTER

Order No.: 2905872

- Programming adapter for wireless communication via Bluetooth



### Marking labels

**UCT-EM (30x5)** Order No. 0801505

**UCT-EM (30x5) CUS** Order No. 0801589

**UCT-EM (30x5) YE** Order No. 0830340

**UC-EMLP (15x5)** Order No. 0819301

**UC-EMLP (15x5) CUS** Order No. 0824550

- For snapping or sticking onto module cover
- Can be marked with THERMOMARK CARD or BLUEMARK printer
- Marking field: 30 x 5 mm/15 x 5 mm



### Adhesive labels

#### SK 5,0 WH:REEL

Order No.: 0805221

- Self-adhesive marker strips, unmarked, continuous
- Roll material for marking with THERMOMARK ROLL thermal transfer printer

You can find other marking materials, printers, and printing accessories on our website:  
[phoenixcontact.com](http://phoenixcontact.com)



### Current transformer for retrofitting

#### PACT RCP-4000A-UIRO-PT-D95

Order No.: 2906234

- Set with 300 mm coil length

#### PACT RCP-4000A-UIRO-PT-D140

Order No.: 2906235

- Set with 450 mm coil length

#### PACT RCP-4000A-UIRO-PT-D190

Order No.: 2906236

- Set with 600 mm coil length

#### PACT RCP-CLAMP

Order No.: 2904895

- Coil holding device for busbars



## Isolating, converting, filtering, and amplifying – the functions at a glance

### Electrical isolation

The most important task of a signal conditioner is the electrical isolation of signals. MINI Analog Pro offers consistent isolation of input, output, and supply. As such, ground current loops can be prevented in the event of potential differences, which would otherwise lead to a distortion of the measured process values.

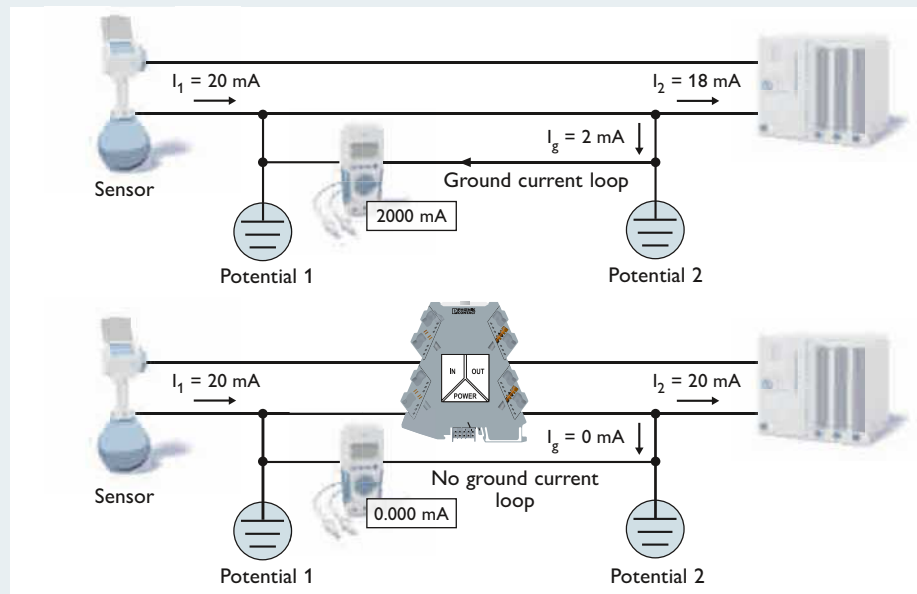

### Converting signals

An advantage of signal conversion is the conversion of sensor signals into a signal that can be read by the controller. In addition, signals susceptible to interference can be converted into less sensitive signals.

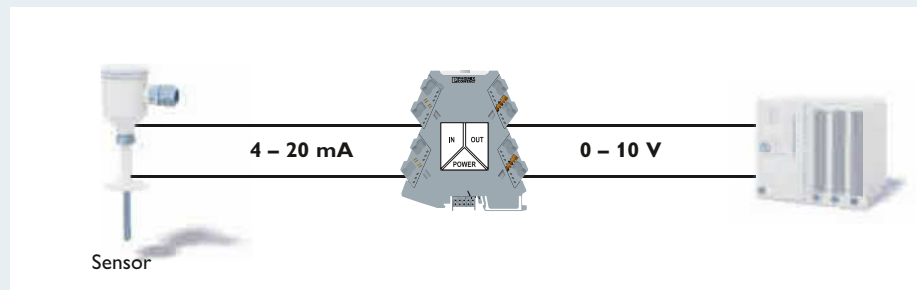

### Amplifying signals

Signals always need to be amplified in the event that cables are long or if high loads are to be driven. It is here that the signal conditioners of the MINI Analog Pro range provide a high output power at a low input power.

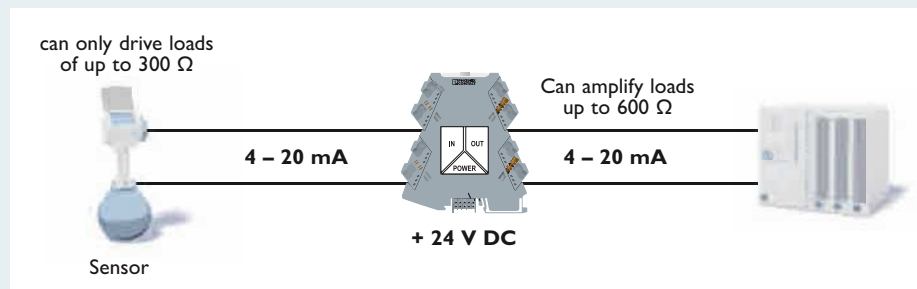

### Filtering signals

In industrial environments, interference often occurs as a result of high-frequency signals. The input filters of the MINI Analog Pro signal conditioners therefore reliably filter out such interference signals.

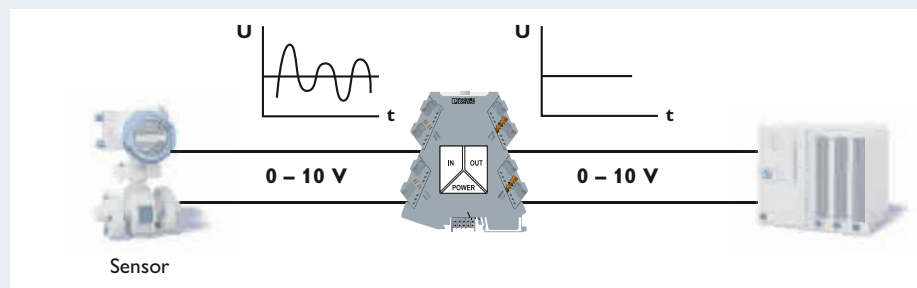



Always up to date, always available – find out about our products, solutions, and services here:

[phoenixcontact.com](http://phoenixcontact.com)

## Product range

- Lighting and signaling
- Electronics housings
- Electronic switching devices and motor control
- Fieldbus components and systems
- Functional Safety
- HMIs and industrial PCs
- I/O systems
- Industrial Ethernet
- Industrial communication technology
- Installation and mounting material
- Cables and lines
- PCB terminal blocks and PCB connectors
- Marking and labeling
- Measurement and control technology
- Monitoring
- Terminal blocks
- Relay modules
- Protective devices
- Sensor/actuator cabling
- Software
- Connectors
- Controllers
- Power supplies and UPS
- System cabling for controllers
- Surge protection and interference suppression filters
- Tools
- Wireless data communication

PHOENIX CONTACT GmbH & Co. KG  
Flachmarktstraße 8  
32825 Blomberg, Germany  
Phone: + 49 5235 3-00  
Fax: + 49 5235 3-41200  
E-mail: [info@phoenixcontact.com](mailto:info@phoenixcontact.com)  
[phoenixcontact.com](http://phoenixcontact.com)



Компания «ЭлектроПласт» предлагает заключение долгосрочных отношений при поставках импортных электронных компонентов на взаимовыгодных условиях!

Наши преимущества:

- Оперативные поставки широкого спектра электронных компонентов отечественного и импортного производства напрямую от производителей и с крупнейших мировых складов;
- Поставка более 17-ти миллионов наименований электронных компонентов;
- Поставка сложных, дефицитных, либо снятых с производства позиций;
- Оперативные сроки поставки под заказ (от 5 рабочих дней);
- Экспресс доставка в любую точку России;
- Техническая поддержка проекта, помощь в подборе аналогов, поставка прототипов;
- Система менеджмента качества сертифицирована по Международному стандарту ISO 9001;
- Лицензия ФСБ на осуществление работ с использованием сведений, составляющих государственную тайну;
- Поставка специализированных компонентов (Xilinx, Altera, Analog Devices, Intersil, Interpoint, Microsemi, Aeroflex, Peregrine, Syfer, Eurofarad, Texas Instrument, Miteq, Cobham, E2V, MA-COM, Hittite, Mini-Circuits, General Dynamics и др.);

Помимо этого, одним из направлений компании «ЭлектроПласт» является направление «Источники питания». Мы предлагаем Вам помощь Конструкторского отдела:

- Подбор оптимального решения, техническое обоснование при выборе компонента;
- Подбор аналогов;
- Консультации по применению компонента;
- Поставка образцов и прототипов;
- Техническая поддержка проекта;
- Защита от снятия компонента с производства.



#### Как с нами связаться

**Телефон:** 8 (812) 309 58 32 (многоканальный)

**Факс:** 8 (812) 320-02-42

**Электронная почта:** [org@eplast1.ru](mailto:org@eplast1.ru)

**Адрес:** 198099, г. Санкт-Петербург, ул. Калинина, дом 2, корпус 4, литера А.