

E-T-A Thermal-Magnetic Circuit Breaker 2210-T2..

Description

One, two and three pole thermal-magnetic circuit breakers with trip-free mechanism and toggle actuation (S-type TM CBE to EN 60934/IEC 934). Featuring a combi-foot design for both symmetric and asymmetric rail mounting. Available with auxiliary contact (1 x N/O or 1 x N/C) for status signalling. Two and three pole models are internally linked to ensure that both/all poles trip in the event of an overload on one pole, even if the actuator is held in the ON position. This CBE can be supplied in current ratings up to 32 A with a choice of characteristic curves. All screw terminals are recessed for safety. Approved to CBE standard EN 60934 (IEC 60934).

Typical applications

Process control equipment, robotics, machine tool control, communications systems, instrumentation.

Features

- Comprehensive approvals allow global use
- Current rating range from 0.1 A to 32 A
- Very small width of only 12.5 mm including auxiliary contacts
- High vibration resistance to DNV GL Class B for mounting with combustion engines, pumps, compressors
- Compliant with the relevant requirements of the railway standards DIN EN 50155, DIN EN 61373 and EN 45545 (detailed information upon request)



2210-T2..
2-pole

Your benefits

- Space and weight savings of at least 50 % compared to conventional MCBs
- Reduced assembly times thanks to integral auxiliary contacts
- Optimum equipment protection through fine grading of current ratings

Preferred types – for more details on all configurations please see order numbering code

Preferred types are E-T-A products most frequently used by E-T-A customers. We manufacture E-T-A preferred types in particularly high

volumes. Our preferred types are supplied at shorter lead times than non-standard versions.

| Preferred types | Standard current ratings (A) | | | | | | | | | | | |
|----------------------|------------------------------|---|---|---|---|---|---|---|----|----|----|---|
| | 0.5 | 1 | 2 | 3 | 4 | 5 | 6 | 8 | 10 | 16 | 20 | |
| 1-pole | | | | | | | | | | | | |
| 2210-T210-K0M1-H121- | x | x | x | x | x | x | x | x | x | x | x | x |
| 2-pole | | | | | | | | | | | | |
| 2210-T220-K0M1-H221- | | | x | | x | | x | | x | x | x | x |

Approvals



Data sheet

For access to the latest documents please follow: www.e-t-a.de/en053

Compliances



Technical data

For further details please see: www.e-t-a.de/ti_e

| | | |
|---|---|---|
| Voltage rating | AC 250 V; 3 AC 433 V (50/60 Hz); DC 65 V (UL: AC 277/480 V; DC 65 V) | |
| Current rating range | 0.1...32 A for curves M1, T1 0.1...16 A for curves F1, F2 | |
| Auxiliary circuit | 1 A, AC 240 V / DC 65 V, resistive (min. 10 V / 10 mA) | |
| Typical life | 3 AC 433 V; AC 250 V: 0.1...25 A 10,000 operations at 1 x I _N , inductive | |
| DC 65 V: | 0.1...32 A 10,000 operations at 1 x I _N , inductive | |
| 3 AC 433 V; AC 250 V: | 32 A 6,000 operations at 1 x I _N , resistive | |
| Ambient temperature | -30...+60 °C (-22...+140 °F) T 60 | |
| Insulation co-ordination (IEC 60664 and 60664 A) | rated impulse withstand voltage 2.5 kV reinforced insulation in operating area | pollution degree 2 |
| Dielectric strength (IEC 60664 and 60664A) | test voltage operating area main/aux. circuit pole/pole | AC 3,000 V AC 3,000 V AC 1,500 V |
| Insulation resistance | > 100 MΩ (DC 500 V) | |
| Interrupting capacity I _{cn} | 0.1...5 A 6...32 A | 400 A 800 A |
| Interrupting capacity (UL 1077) | curves F1, F2, M1, T1: | 0.1...16 A 2,500 A (at DC 32 V) |
| I _N | 0.1...16 A | 20...32 A |
| AC 277 V 1-pole | 5,000 A | 2,000 A |
| AC 277/480 V 2-/3-pole | 5,000 A | 2,000 A |
| DC 65 V | 2,000 A | 2,000 A |
| Degree of protection (IEC 60529/DIN 40050) | operating area IP30 terminal area IP20 | |
| Vibration | curves F1, F2: | 3 g (57-500 Hz), ± 0.23 mm (10-57 Hz) |
| | curves M1, T1: | 5 g (57-500 Hz), ± 0.38 mm (10-57 Hz) to IEC 60068-2-6, test Fc 10 frequency cycles/axis |
| Shock | curves F1, F2: | 25 g (11 ms), directions 1, 2, 3, 4, 5 10 g (11 ms), direction 6 |
| | curves M1, T1: | 25 g (11 ms), directions 1, 2, 3, 4, 5 20 g (11 ms), direction 6 to IEC 60068-2-27, test Ea |
| Corrosion | 96 hours at 5 % salt mist to IEC 60068-2-11, test Ka | |
| Humidity | 240 hours at 95 % RH to IEC 60068-2-78, test Cab | |
| Mass | approx. 60 g per pole | |

Standard current ratings and typical internal resistance values

| Current rating (A) | Internal resistance (Ω) | | | |
|--------------------|----------------------------|-------------------------------------|-----------------------|--|
| | F1 | F2 | M1 | T1 |
| | fast acting for DC only | fast acting delay for AC + DC | standard for AC+DC | delayed low resistance for AC only |
| 0.1 | 162 | 162 | 92 | 81 |
| 0.2 | 39.3 | 39.3 | 26.1 | 24.2 |
| 0.3 | 17.5 | 17.5 | 11.6 | 10.4 |
| 0.4 | 9.2 | 9.2 | 6.6 | 6.0 |
| 0.5 | 6.8 | 6.8 | 4.1 | 3.9 |
| 0.6 | 4.2 | 4.2 | 3 | 2.7 |
| 0.8 | 2.8 | 2.8 | 1.65 | 1.53 |
| 1 | 1.6 | 1.6 | 1.10 | 0.98 |
| 1.5 | 0.78 | 0,78 | 0.47 | 0.42 |
| 2 | 0.42 | 0,42 | 0.28 | 0.24 |
| 2.5 | 0.26 | 0.26 | 0.183 | 0.17 |
| 3 | 0.18 | 0.18 | 0.124 | 0.12 |
| 4 | 0.12 | 0.12 | 0.077 | 0.073 |
| 5 | 0.092 | 0.092 | 0.063 | 0.055 |
| 6 | 0.054 | 0.054 | 0.045 | 0.039 |
| 8 | 0.025 | 0.025 | ≤ 0.02 | ≤ 0.02 |
| 10 | 0.022 | 0.02 | ≤ 0.02 | ≤ 0.02 |
| 12 | ≤ 0.02 | ≤ 0.02 | ≤ 0.02 | ≤ 0.02 |
| 16 | ≤ 0.02 | ≤ 0.02 | ≤ 0.02 | ≤ 0.02 |
| 20 | - | - | ≤ 0.02 | ≤ 0.02 |
| 25 | - | - | ≤ 0.02 | ≤ 0.02 |
| 32 | - | - | ≤ 0.02 | ≤ 0.02 |

Approvals

| Authority | Standard | Rated voltage | Current ratings |
|-----------|---------------------------------|--------------------------------------|--|
| VDE | IEC/EN 60934 | 3 AC 433 V AC 250 V DC 65 V | 0.1 A...32 A 0.1 A...32 A 0.1 A...32 A |
| UL | UL 1077 | AC 277/480 V AC 277 V DC 65 V | 0.1 A...32 A 0.1 A...32 A 0.1 A...32 A |
| CSA | C22.2 No 235 | AC 277/480 V AC 277 V DC 65 V | 0.1 A...32 A 0.1 A...32 A 0.1 A...32 A |
| CQC | GB 17701 | AC 250/433 V AC 250 V DC 65 V | 0.1 A...32 A 0.1 A...32 A 0.1 A...32 A |
| DNV GL | IEC 60934, DNVGL- CG 0339 | 3 AC 433 V AC 250 V DC 65 V | 0.1 A...32 A 0.1 A...32 A 0.1 A...32 A |
| KTL | KC60934 | AC 250 V, 1-pole AC 433 V, 2-pole | 0.1 A...16 A 0.1 A...16 A |

Preferred types

Preferred types are E-T-A products most frequently used by E-T-A customers. We manufacture E-T-A preferred types in particularly high volumes. Our preferred types are supplied at shorter lead times than non-standard versions.

| Preferred types | Standard current ratings (A) | | | | | | | | | | | |
|----------------------|------------------------------|---|---|---|---|---|---|---|----|----|----|---|
| | 0.5 | 1 | 2 | 3 | 4 | 5 | 6 | 8 | 10 | 16 | 20 | |
| 1-pole | | | | | | | | | | | | |
| 2210-T210-K0M1-H121- | x | x | x | x | x | x | x | x | x | x | x | x |
| 2-pole | | | | | | | | | | | | |
| 2210-T220-K0M1-H221- | | | x | | x | | x | | x | | x | x |

Ordering information

Type No.

2210 single and multipole thermal-magnetic circuit breaker

Mounting

T rail mounting

Actuator design

2 toggle

Number of poles

1 single pole protected

2 2-pole protected

3 3-pole protected

Accessories

0 without accessories

Terminal design (main contacts)

K0 screw terminals

Characteristic curve

F1 fast acting: therm. 1.01-1.4xI_N;
magn. 2-4xI_N DC (DC only)

F2 fast acting: therm. 1.01-1.4xI_N;
magn. 3,5-6,5xI_N AC/4,5-8,5xI_N DC

M1 standard delay: therm. 1.01-1.4xI_N;
magn. 6-12xI_N AC, 7,8-15,6xI_N DC

T1 delayed: therm. 1.01-1.4xI_N; magn. 10-20xI_N AC

Auxiliary contact design

H without intermediate position

Auxiliary contacts

1 with auxiliary contacts

2 auxiliary contacts on pole 1 only
(multipole devices)

Auxiliary contact function (see diagrams)

2 1 N/O contact

3 1 N/C contact

Auxiliary contact - terminal design

1 screw terminals

Current ratings

0.1...32 A

2210 - T 2 1 0 - K0 M1 - H 1 2 1 - 10 A ordering example

Please be informed that we have minimum ordering quantities to be observed.

Custom designed versions

Looking for a version you cannot find in our ordering number code? Please get in touch. We will be pleased to find a solution for you.

Typical time/current characteristics

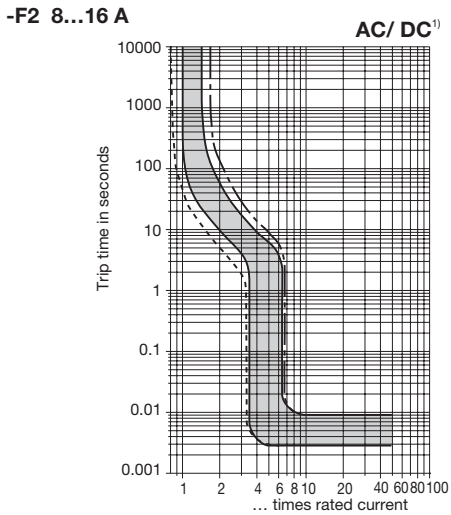
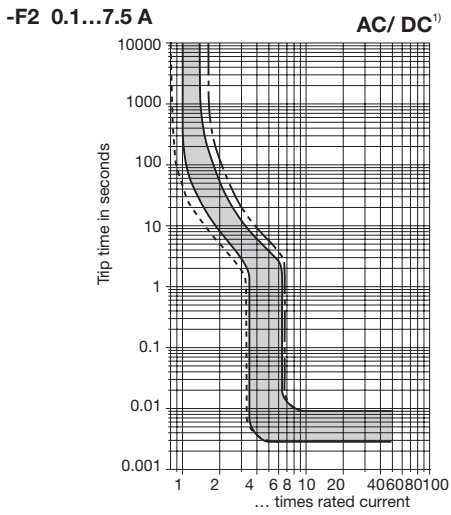
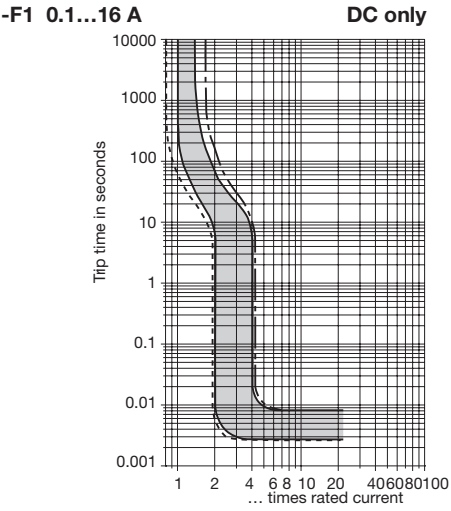

--- +60 °C ——— +23 °C - · - · -30 °C
 +140 °F +73.4 °F -22 °F

¹⁾Magnetic tripping currents are increased by 30% on DC supplies.

1

Typical time/current characteristics

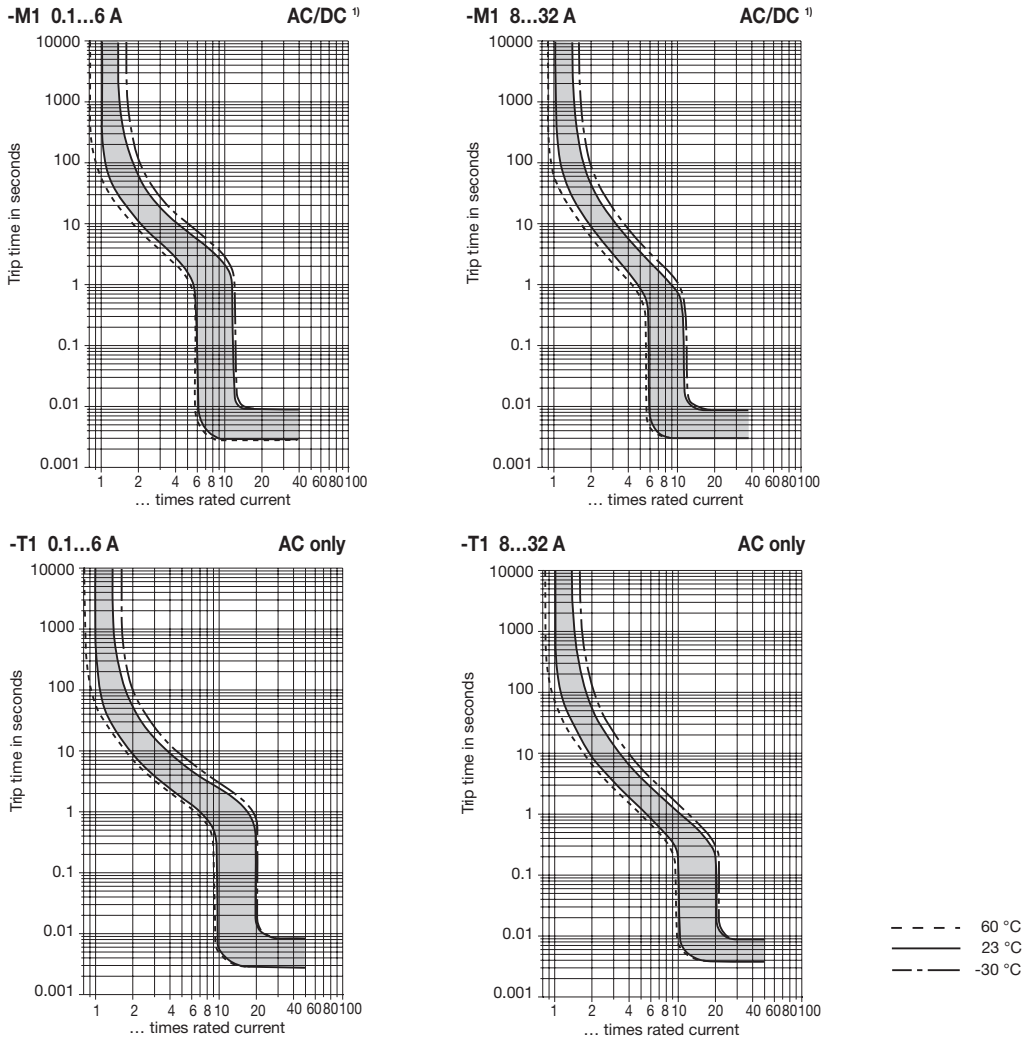

The time/current characteristic curve depends on the ambient temperature prevailing. In order to eliminate nuisance tripping, please multiply the circuit breaker current ratings by the derating factor shown below. See also section Technical information.

| Ambient temp. | -22 °F -30 °C | -4 °F -20 °C | +14 °F -10 °C | +32 °F 0 °C | +73.4 °F +23 °C | +86 °F +30 °C | +104 °F +40 °C | +122 °F +50 °C | +140 °F +60 °C |
|-----------------|------------------|-----------------|------------------|----------------|--------------------|------------------|-------------------|-------------------|-------------------|
| Derating factor | 0.76 | 0.79 | 0.83 | 0.88 | 1 | 1.04 | 1.11 | 1.19 | 1.29 |

Multi pole devices: all poles symmetrically loaded. With single pole overload, thermal tripping will be at max. $1.7 \times I_N$ with curves F1, F2 and M1.

¹⁾ Magnetic tripping currents are increased by 30 % on DC supplies (curves F2, M1).

Accessories

Connector bus links -K10

X210 589 01/ 2.5 mm², (AWG 14) (black) up to 20 A max. load
X210 589 02/ 1.5 mm², (AWG 16) (brown) up to 13 A max. load

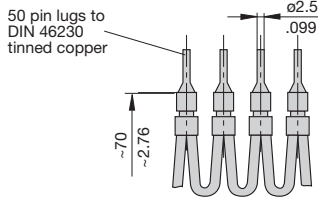

Busbar 1-pole, 90° X 222 540 11

The one metre long busbars can be cut to suitable lengths. Plug-on caps can be fitted on the ends to provide brush contact protection. cross section: 16 mm²



Busbar 1-pole Y 308 498 01

cross section: 16 mm²



Busbar for 1-pole devices

Firmly mounted supply terminals, placed at fixed distances (1 supply terminal every 7 modules)
 For cable feed from the side

Ideal for applications with high vibration requirements

Y31270901 cross section: 16 mm²

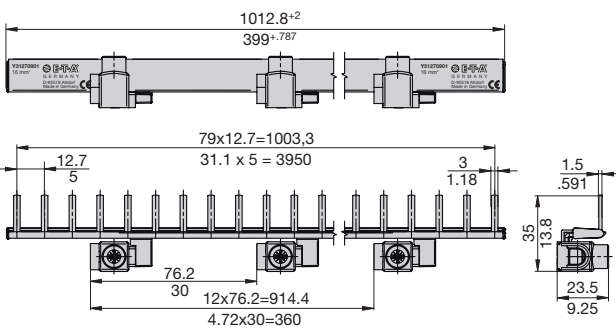

Plug-on cap, 1-pole

Y 307 851 01



Busbar 2-pole

Y 308 499 01 cross section: 16 mm²



Plug-on cap, busbar 2/3-pole

Y 308 506 01

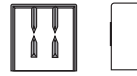

Busbar 3-pole

Y 308 500 01

cross section: 16 mm²



Plug-on cap, busbar 2/3-pole

Y 308 506 01



Supply terminal

Y 308 503 01

I_{max} 63 A with 1-pole busbar,

50 A with multipole busbar

Max. tightening torque of terminal screw 2 Nm

Max. cable cross section: 25 mm² / single strand

16 mm² / multistrand

with wire end ferrule

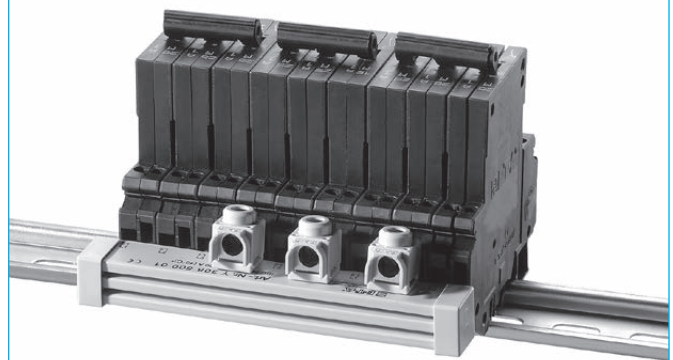
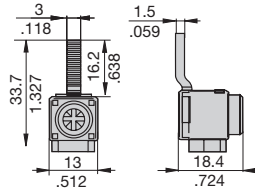

Caution:

When using multipole busbars please leave at least one pole's width between two adjacent line entry terminals.

This is a metric design and millimeter dimensions take precedence ($\frac{\text{mm}}{\text{inch}}$)

All dimensions without tolerances are for reference only. In the interest of improved design, performance and cost effectiveness the right to make changes in these specifications without notice is reserved. Product markings may not be exactly as the ordering codes. Errors and omissions excepted.



Компания «ЭлектроПласт» предлагает заключение долгосрочных отношений при поставках импортных электронных компонентов на взаимовыгодных условиях!

Наши преимущества:

- Оперативные поставки широкого спектра электронных компонентов отечественного и импортного производства напрямую от производителей и с крупнейших мировых складов;
- Поставка более 17-ти миллионов наименований электронных компонентов;
- Поставка сложных, дефицитных, либо снятых с производства позиций;
- Оперативные сроки поставки под заказ (от 5 рабочих дней);
- Экспресс доставка в любую точку России;
- Техническая поддержка проекта, помощь в подборе аналогов, поставка прототипов;
- Система менеджмента качества сертифицирована по Международному стандарту ISO 9001;
- Лицензия ФСБ на осуществление работ с использованием сведений, составляющих государственную тайну;
- Поставка специализированных компонентов (Xilinx, Altera, Analog Devices, Intersil, Interpoint, Microsemi, Aeroflex, Peregrine, Syfer, Eurofarad, Texas Instrument, Miteq, Cobham, E2V, MA-COM, Hittite, Mini-Circuits, General Dynamics и др.);

Помимо этого, одним из направлений компании «ЭлектроПласт» является направление «Источники питания». Мы предлагаем Вам помощь Конструкторского отдела:

- Подбор оптимального решения, техническое обоснование при выборе компонента;
- Подбор аналогов;
- Консультации по применению компонента;
- Поставка образцов и прототипов;
- Техническая поддержка проекта;
- Защита от снятия компонента с производства.



Как с нами связаться

Телефон: 8 (812) 309 58 32 (многоканальный)

Факс: 8 (812) 320-02-42

Электронная почта: org@eplast1.ru

Адрес: 198099, г. Санкт-Петербург, ул. Калинина, дом 2, корпус 4, литера А.