

UM11055

NXP USB Type-C Shield 2 Demo Kit User Manual

Rev. 1.0 — 18 October 2018

User manual
COMPANY PUBLIC

Document information

Information	Content
Keywords	USB Type-C, PD (power delivery), Alt-mode-DP, Host, Dock, Shield, PTN5110, PTN5110N
Abstract	This user manual presents demonstration / application kit capability of power, data, video delivery through single USB Type-C cable between a Shield host board and a Shield dock board, also the power swap, different power profile request capability between these two boards.



Revision history		
Rev	Date	Description
1.0	20181018	First Release

1 Introduction

PTN5110N is a 1-port TCPC compliant USB Power Delivery (PD) PHY IC that implements Type-C Configuration channel interface and USB PD Physical layer functions to a Type-C Port Manager that handles PD Policy management. It complies with USB PD, Type-C and TCPC specifications and relevant ECNs/ECRs. This IC is targeted primarily for use in system platforms.

PTN5110N is a USB PD TCPC PHY IC, in HX2QFN16 2.6 mm x 2.6 mm x 0.35 mm, 0.4 mm pitch package.

The demo contains two separate kits: one for the host side (Host board - OM13790HOST), and one for the device side (Dock board - OM13790DOCK). Host and Dock boards both have all the same connectors except one - Host board has USB3 Type-B connector, dock board has USB3 Type-A connector.

The demo is intended to demonstrate power and USB data / display port video delivery through a single USB Type-C cable between a host board and a dock board, as well as the power swap and high/low power request capability between the host and the dock boards.

This document is intended to be used as the user manual of NXP USB Type-C Shield 2 demo.

- Overall PCB connectors, jumpers, and power supplies
- Laptop and VGA monitor that this demo will be interfacing with during demo
- System level connections such as cables and connectors that this demo will need

1.1 Purposes

- This demo allows customers to evaluate NXP USB Type-C Power Delivery PHY and protocol IC PTN5110N and DP Alternate Mode features through single USB Type-C connection.
 - Power swap between the host and the dock boards
 - Power delivery between the host and the dock boards during dead battery condition
 - Power delivery selection between 5V or 9V
 - CC logic and PD control through Arduino headers to a microcontroller
 - Transfer power, data, video through USB Type-C cable between the host and the dock boards

2 General description

2.1 Block diagram

2.1.1 Shield 2 host board

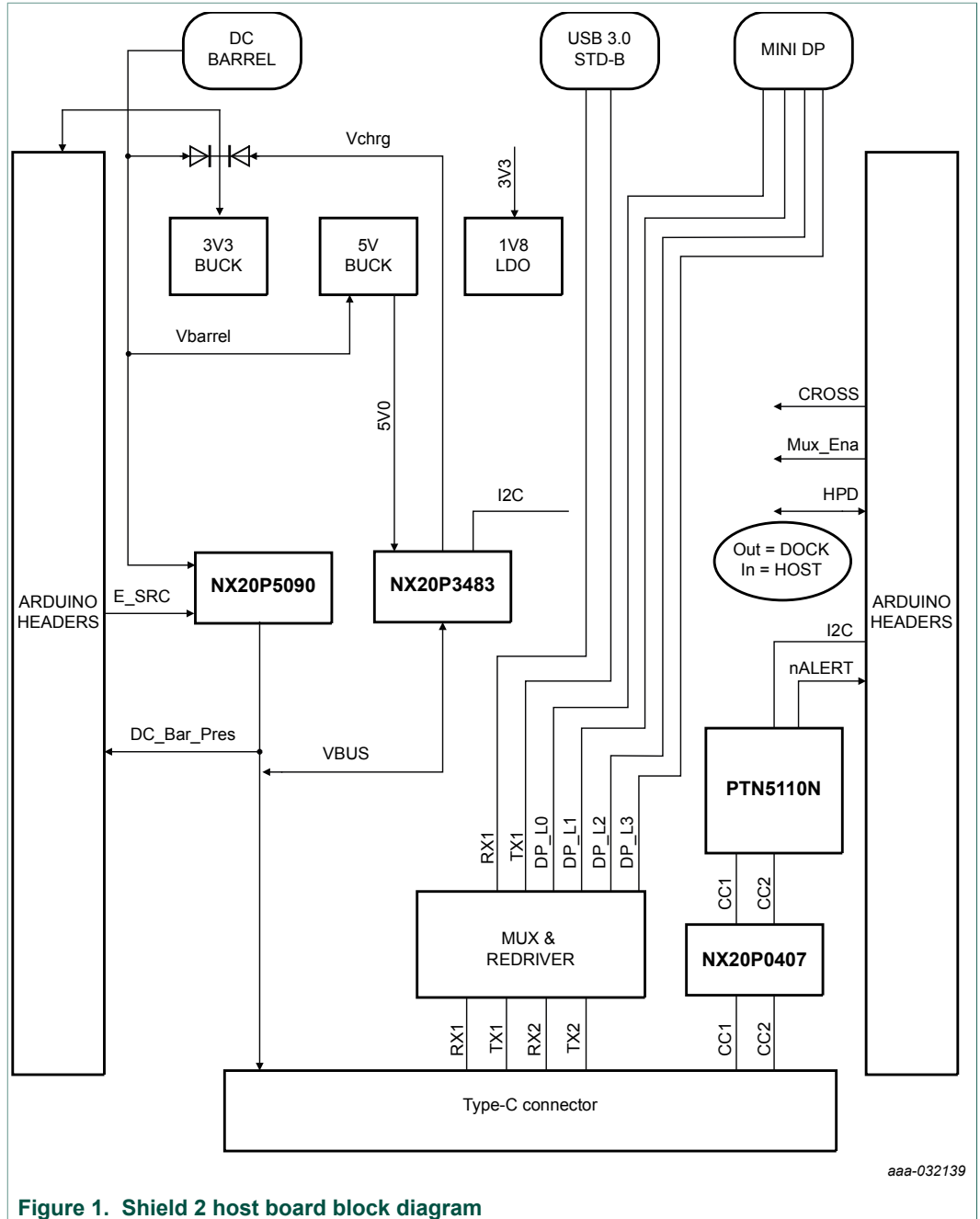

Figure 1. Shield 2 host board block diagram

2.1.2 Shield 2 dock board

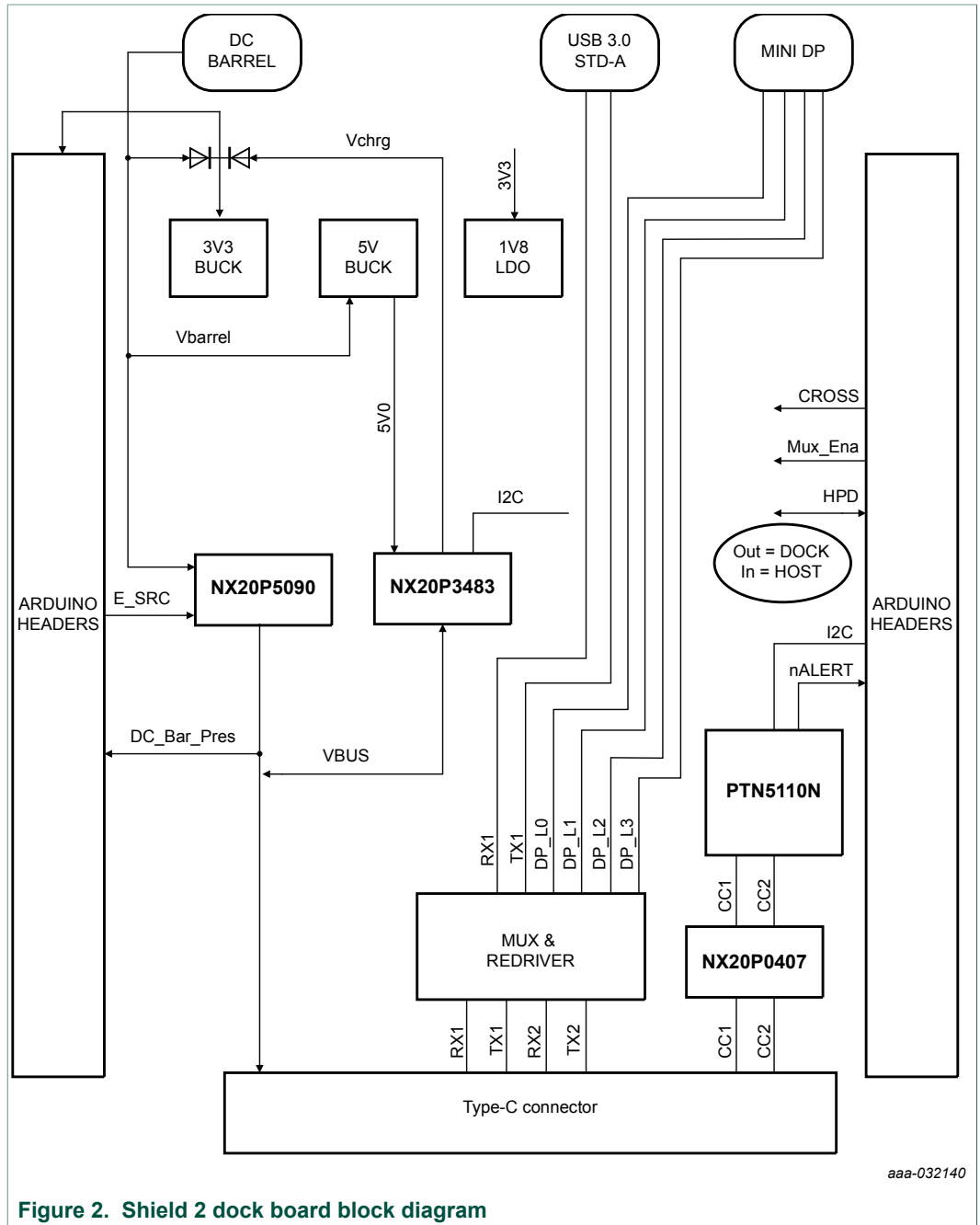

Figure 2. Shield 2 dock board block diagram

2.2 Connectors and jumpers

Please refer to [Figure 3](#) and [Figure 4](#) below to find connectors and jumper's location on the host board and the dock board.

2.2.1 Shield 2 host board connectors and jumpers location

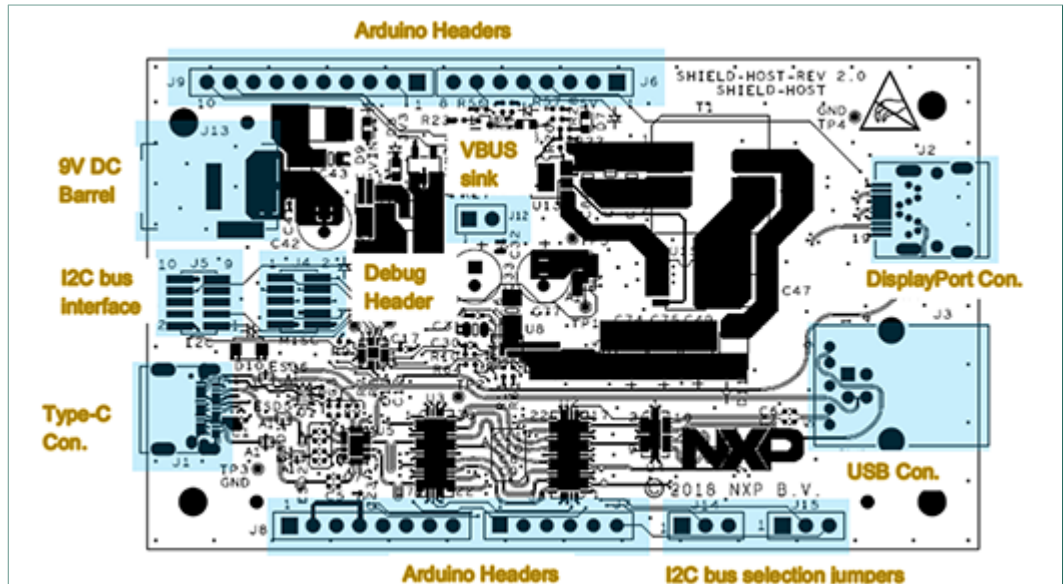

Figure 3. Shield 2 host board connectors and jumpers location

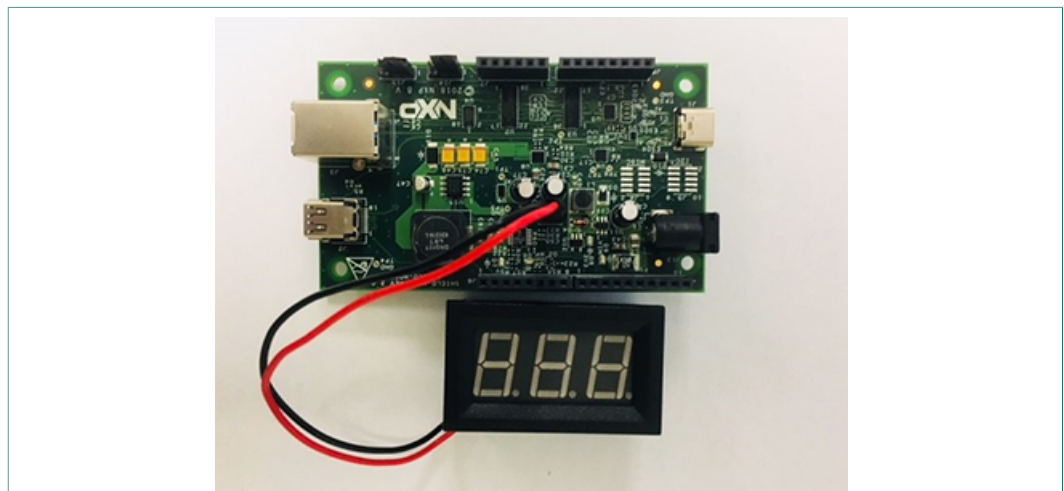

Figure 4. Shield 2 host board connectors and jumpers example

2.2.2 Shield 2 dock board connectors and jumpers location

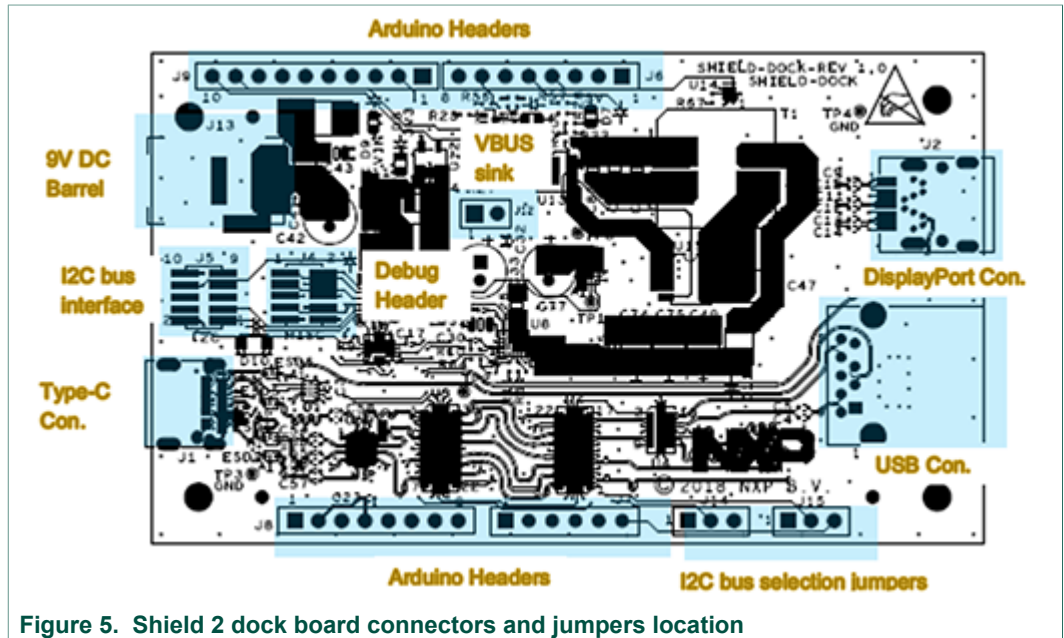

Figure 5. Shield 2 dock board connectors and jumpers location

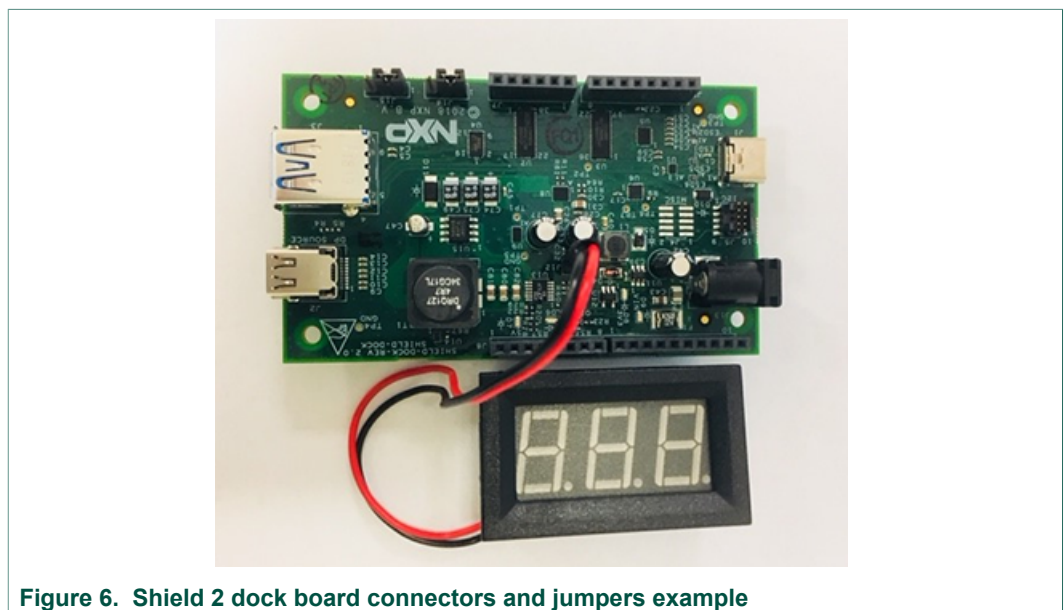

Figure 6. Shield 2 dock board connectors and jumpers example

2.2.3 Connectors list

Both Shield 2 Host/Dock boards have the following connectors:

- Power connector J13 for AC power adapter.
- USB3 connector J3, Type-A on dock board, Type-B on host board.
- Mini-DP receptacle J2.
- USB Type-C receptacle J1.
- Voltmeter 2x1 header with 0.1" spacing J12.

- Debug connectors, micro 2x5, J4.
- I²C (TCPM) interface connector, micro 2x5, J5
- Arduino headers, J6 – J9, for TCPM (LPC54XXX, LPC11U37, KL27Z) interface

2.2.4 Connectors and jumper setting table

Table 1. Connectors jumper setting list

Con/Jumper #	Page Reference	Signal Names	Jumper Type	Jumper Settings	Default Setting
J1	Page 4	USB Type C	USB Type C (Right Angle)		
J3	Page 5	USB_B	USB_B_REC		
J2	Page 5	Mini_DP (Sink)	Mini_DP		
J5	Page 6	I2C HEADER (TCPM)	Micro 2x5	1 I2C_SCL 3 I2C_SDA	
J4	Page 6	Debug HEADER	Micro 2x5		
J13	Page 9	PJ-082BH Power Plug	Power Plug		
J12	Page 9	Power Display Header	1x2	1 Power 2 GND	OPEN
J14	Page 7	I2C Bus SDA Select	1x2	1-2 to select I2C0 2-3 to select I2C1	1-2
J15	Page 7	I2C Bus SCL Select	1x2	1-2 to select I2C0 2-3 to select I2C1	1-2

2.2.5 LED table

Table 2. LED table

LED #	Page Reference	Signal Names
D8	Page 9	3V3
D6	Page 9	1V8
D7	Page 9	5V0
D9	Page 9	DC Barrel

3 Hardware setup

Below is a graphic presentation of the Shield 2 demo hardware setup.

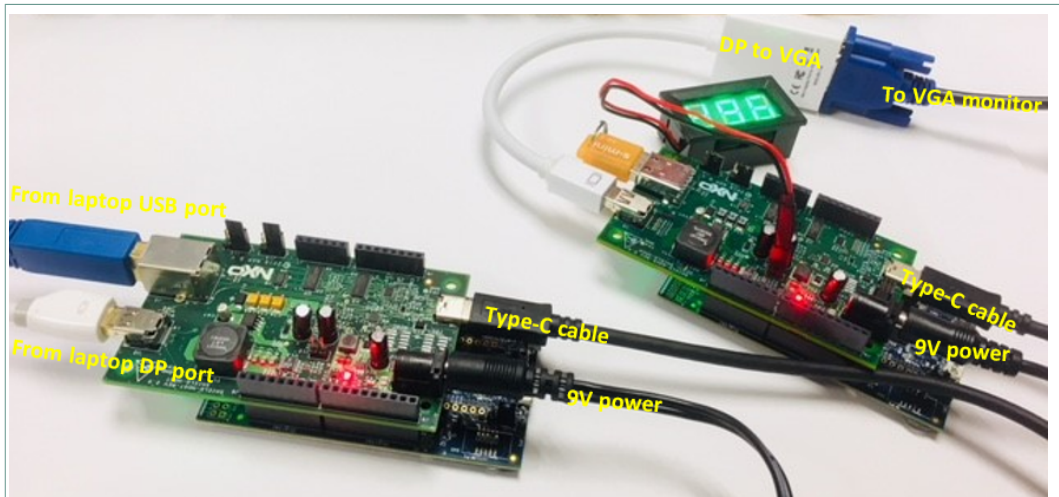

Figure 7. Shield 2 demo kit hardware setup

3.1 Shield 2 demo setup picture

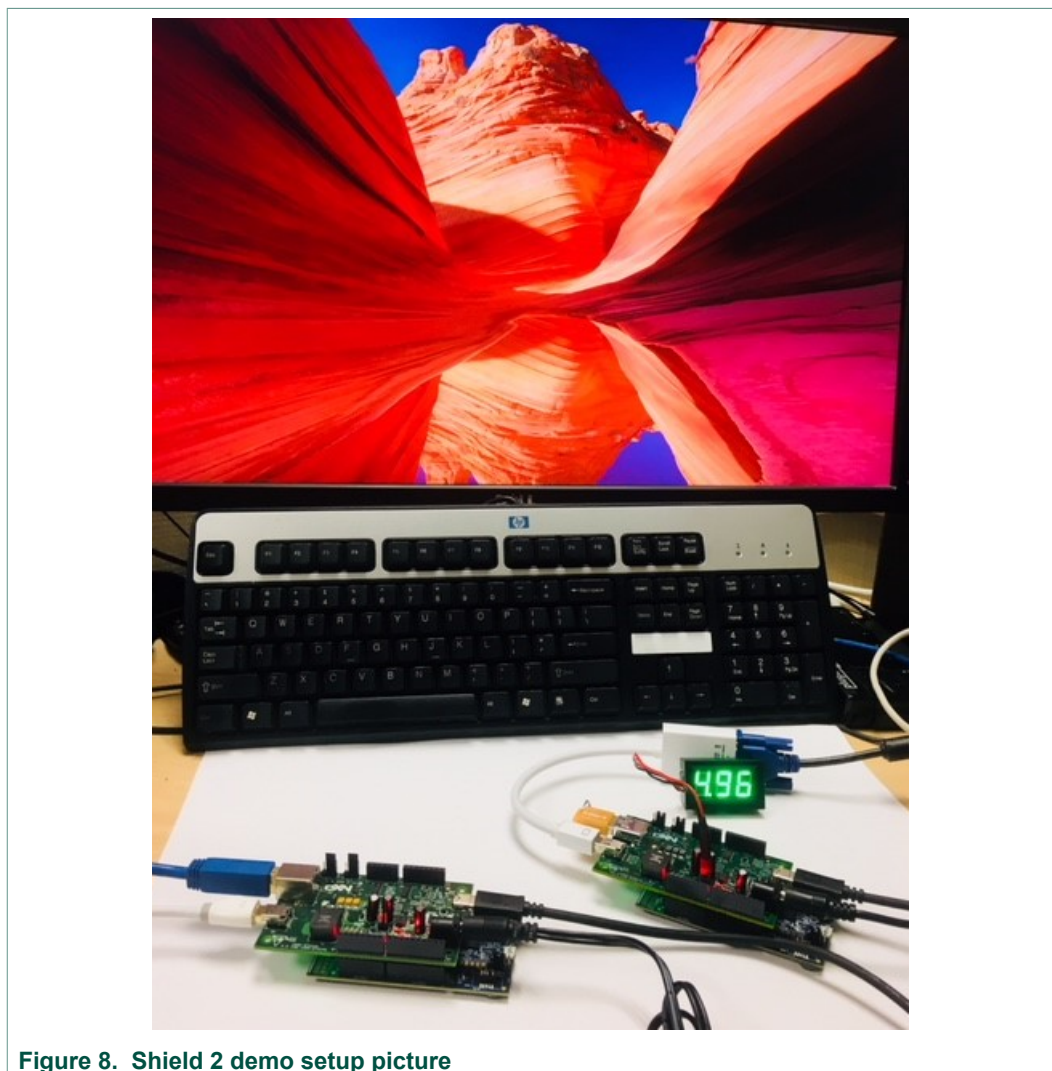

Figure 8. Shield 2 demo setup picture

3.2 Shield 2 host board control and LED indication

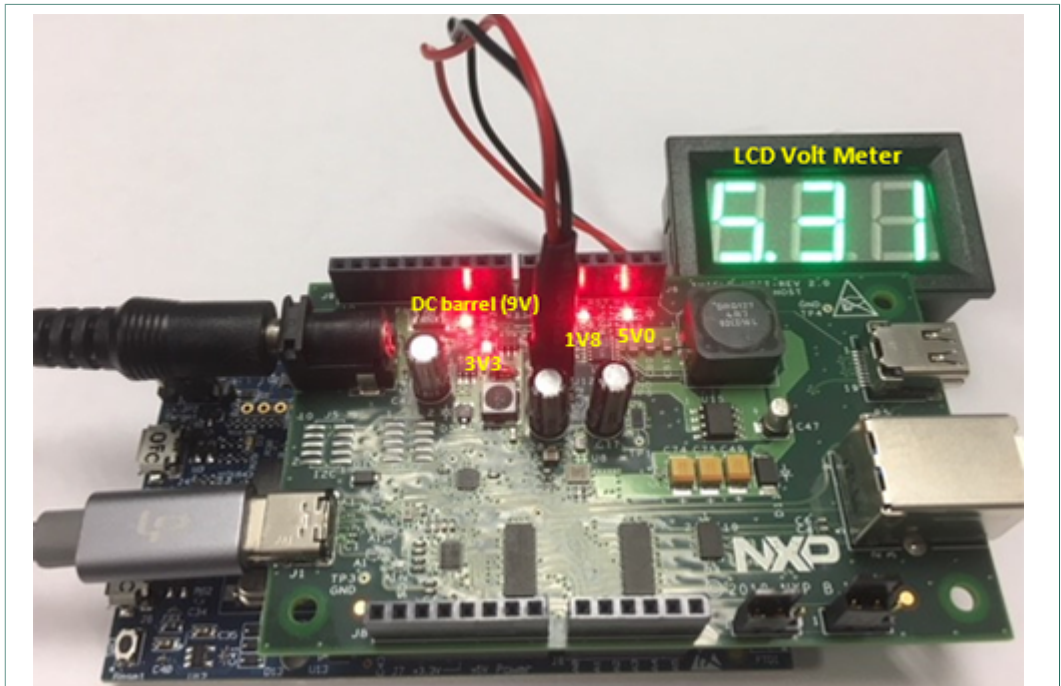

Figure 9. Shield 2 host board control and LED indication

3.3 Shield 2 dock board control and LED indication

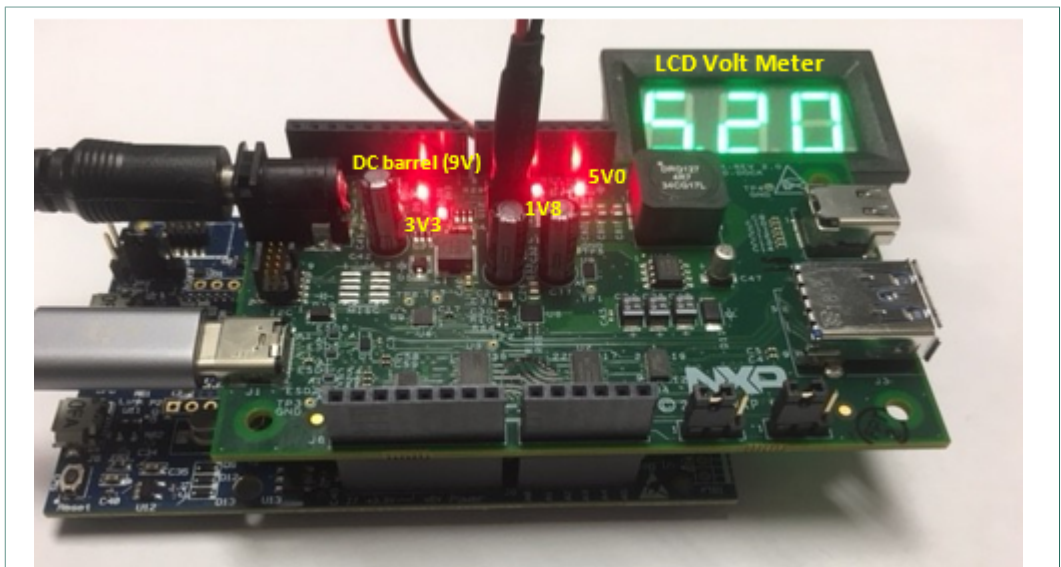

Figure 10. Shield 2 dock board control and LED indication

3.4 Hardware setup procedure

3.4.1 Shield 2 host board

- Connect USB3 cable between Host board J3 and laptop USB 3.0 input port
- Connect Mini-DP cable between Host board J2 and laptop mini-DP input port
- Connect AC/DC power adaptor onto Power connector J13
- Connect Digital Voltmeter with LCD display to J12 (red wire on pin 1)

3.4.2 Shield 2 dock board

- Connect mini DPVGA dongle between Dock board J2 and VGA monitor
- Connect AC/DC power adaptor onto Power connector J13
- Connect Digital Voltmeter with LCD display to J12 (red wire on pin 1)

3.4.3 Shield 2 demo system

- Connect USB Type-C cable between Host and Dock boards on J1
 - 5V should appear on the LCD display of the DOCK board
 - Laptop screen should be on the VGA monitor
- Note:** if the MCU base board is one of these boards: frdmk22f, frdmk64f, frdmkl27z, frdmkl28z, lpcxpresso54018, lpcxpresso54114, lpcxpresso54608, evkbimxrt1050, evkmimxrt1020 and evkmimxrt1060 a user interface menu is available through the serial (virtual COM port) debug port.



Figure 11. Shield 2 demo system

3.5 Shield 2 power sink request 5v, 9v from shield 2 power source board

Once the power contract is established, some debugging messages should be appeared on the serial console on the laptop. These messages are used to indicate whether the host/dock board is a power source, power sink, UFP/DFP role, source PDOs...A test menu will pop up if number '0' is pressed on the keyboard.

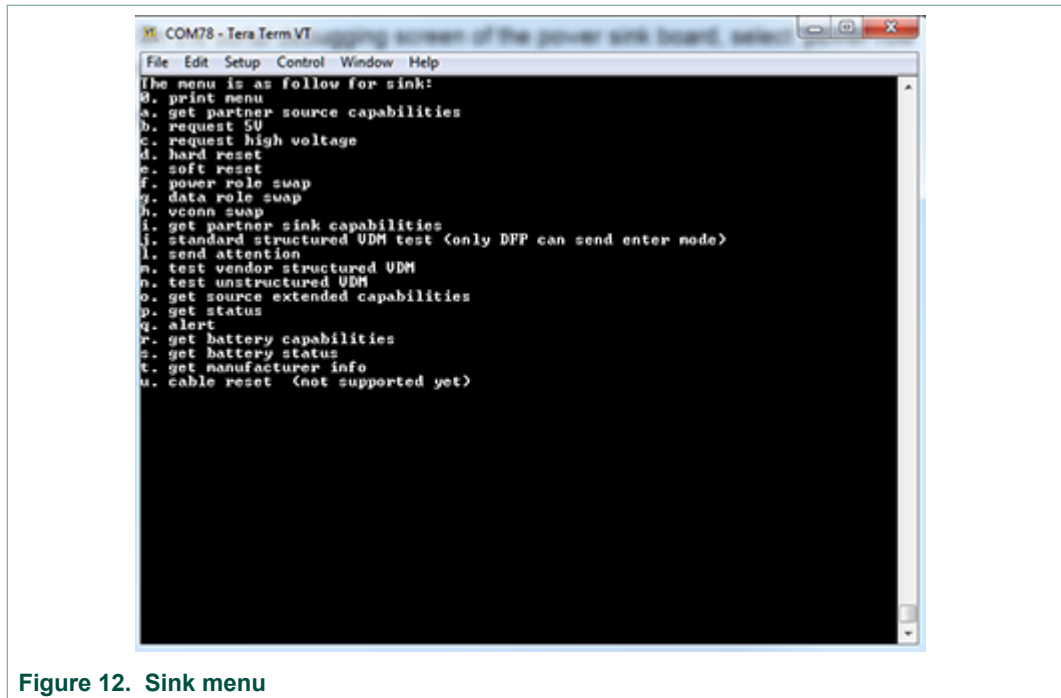

Figure 12. Sink menu

1. On the serial debugging screen of the power sink board, select 'request high voltage' option to request 9V.
2. On the serial debugging screen of the power sink board, select 'request 5V' option to request 5V.
3. On the serial debugging screen of the power sink board, select 'power role swap' option to swap from power sink role to power source role.
4. Follow step 1 and 2 to request 9V or 5V from the new power sink.

3.6 USB PD DP alternate mode

After the HOST board is connected to the DOCK board, 5V should appear on the LCD display of the DOCK board.

Connect a Mini-DP cable between Host board J2 and laptop mini-DP input port. Connect a mini-DPVGA dongle between Dock board J2 and VGA monitor.

Display should show up on the both notebook native monitor and remote VGA monitor in duplicate display mode option setting, or only on VGA monitor in extended display mode option setting.

Different VBUS voltage can be requested from the DOCK board through the serial console interface, and supply by the HOST board while displays are still shown on both native monitor (NB) and VGA monitor.

- On the serial debugging screen of the DOCK, select 'request high voltage' option to request 9V.
- On the serial debugging screen of the DOCK, select 'request 5V' option to request 5V.
- On the serial debugging screen of the DOCK, select 'power role swap' option to swap power role from power sink to power source.

3.7 USB PD DP alternate mode video play demo

Connect a USB3.0 A-B cable between Notebook USB3.0 A port and Host board USB3.0 Type-B receptacle J3. Plug a USB flash drive with movie trailers onto USB3.0 Type-A receptacle on Dock board J3.

From the laptop that is connected to the host board, you should be able to see and access the flash drive on the dock board.

Navigate to the flash drive and play the movie clip from the laptop by double click on the icon.

Display should show up on both NB native monitor and remote VGA monitor in duplicate display mode option setting, or only on VGA monitor in extended display mode option setting.

While the movie clip is playing various VBUS voltages can be requested from the DOCK board, and supply by the HOST board through the serial console screen.

Theory of operation:

Digital video stored in memory stick on Dock board is read by the CPU connected to the Host board via USB3 port on the Host board, the video data is sent to the Host board through USB Type-C cable. The data is further transmitted to the laptop via USB3 cable. The laptop CPU converts video digital data to streaming video then play it back to the Host board through Display Port cable. USB Type-C connection sends the video to the Dock board, video is played out to the monitor through DP-VGA converter dongle to a VGA monitor.

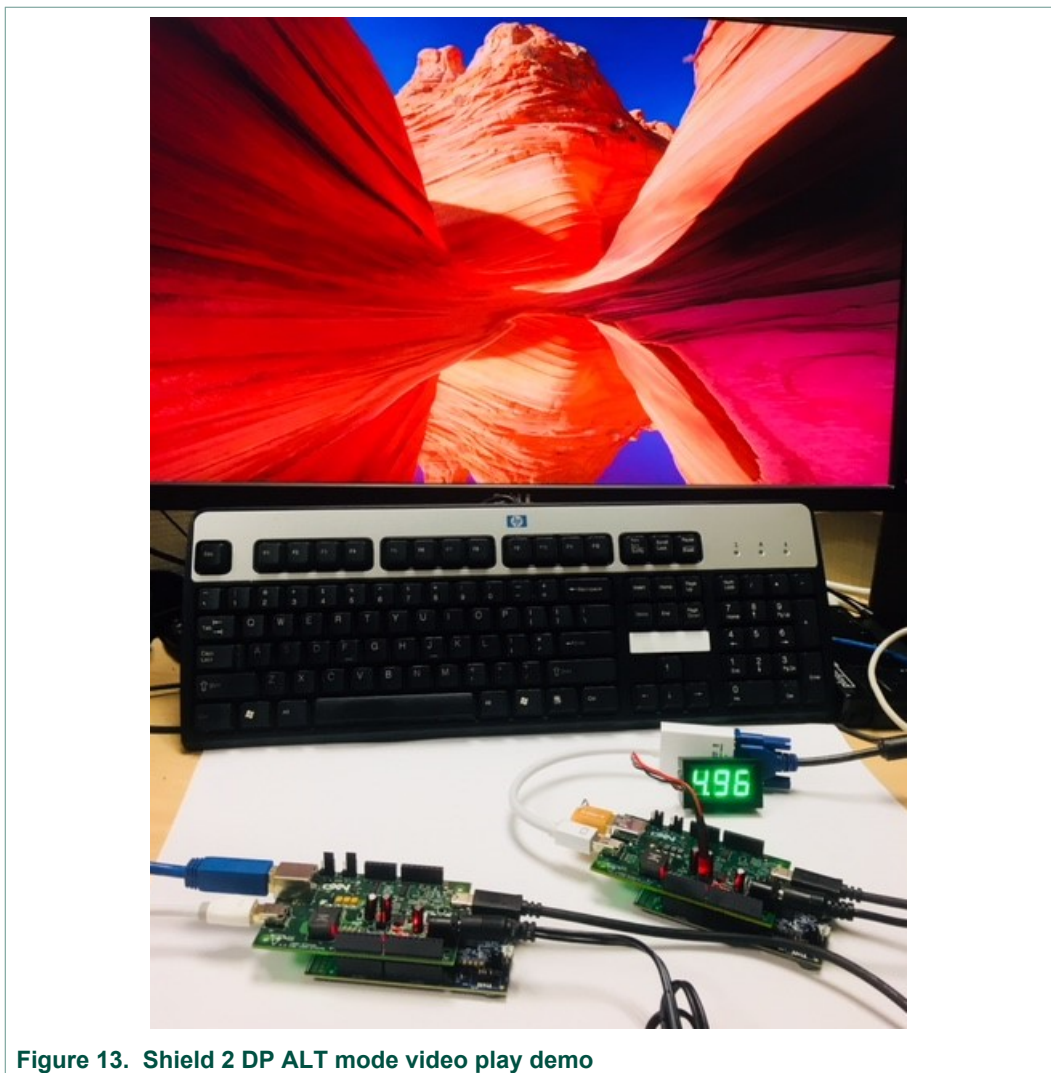

Figure 13. Shield 2 DP ALT mode video play demo

4 Test shield 2 host board only

NXP USB PD Type-C HOST demo board can be used alone to verify Type-C host side functionality. The host board is equivalent to motherboard with Type-C port; while the combined dock board with mini-DP dongle is equivalent to Type-C to DP dongle application.

4.1 Use Type-C to HDMI/VGA dongles to verify host board

Test procedure:

Connect a mini-DP cable from Notebook that has mini-DP port to Host board DP receptacle J2. Connect either a Type-C to HDMI dongle to a HDMI monitor or a Type-C to VGA dongle to a VGA monitor. Notebook shall detect 2nd monitor with monitor name and preferred resolution in extended mode.

Theory of operation:

Video is sent out from NB DP port into Host DP input port. After Type-C connection is established, Shield 2 Host turns on DP ALT mode, and allows video data to be transmitted through Type-C port to either HDMI or VGA monitors.

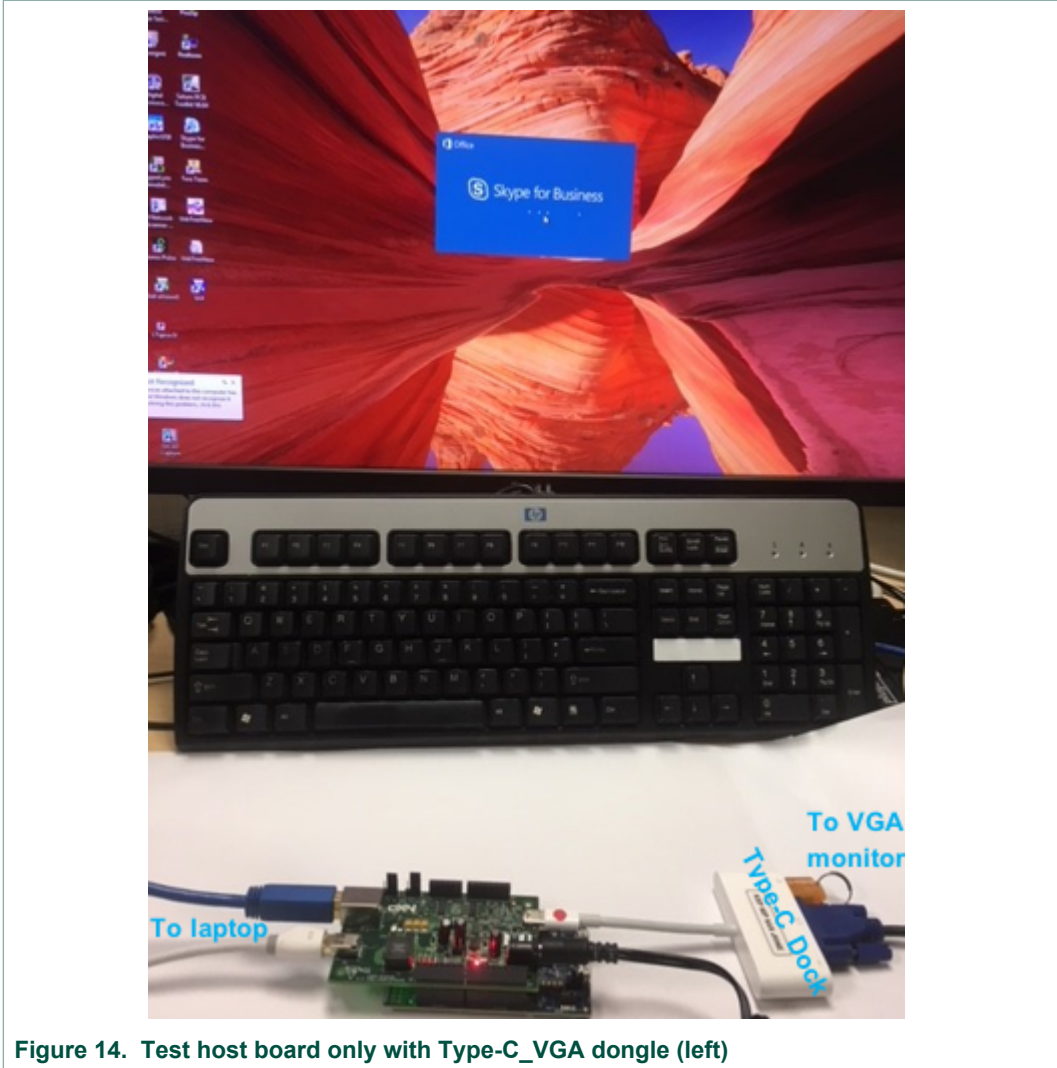

Figure 14. Test host board only with Type-C_VGA dongle (left)

5 Test shield 2 dock board only

NXP USB PD Type-C DOCK demo board can be used alone to verify Type-C dock side functionality. The combined dock board with mini-DP2VGA dongle is equivalent to Type-C to VGA dongle application; while the combined dock board with mini-DP dongle is equivalent to Type-C to DP dongle application.

5.1 Use mini-DP to VGA Dongle to verify Dock Board

Use a Type-C source, such as Mac Book or Chrome Book that has Type-C port to send video or picture files.

1. Connect the dock board to Type-C source (such as Google Chrome as shown) with Type-C cable to Type-C connector J1.
2. Connect a mini-DP2VGA dongle to mini-DP connector J2.
3. Connect a VGA cable from DP2VGA dongle to VGA monitor.
4. 2nd monitor should be detected on Type-C source with 2nd monitor model name and recommended resolution if viewed in extended mode.
5. Play a video clip from desk top of the Type-C source and view the video on 2nd monitor by dragging the video window over to 2nd monitor.
6. Data can be copied onto USB 3 dongle at the same time if one is plugged into J3.

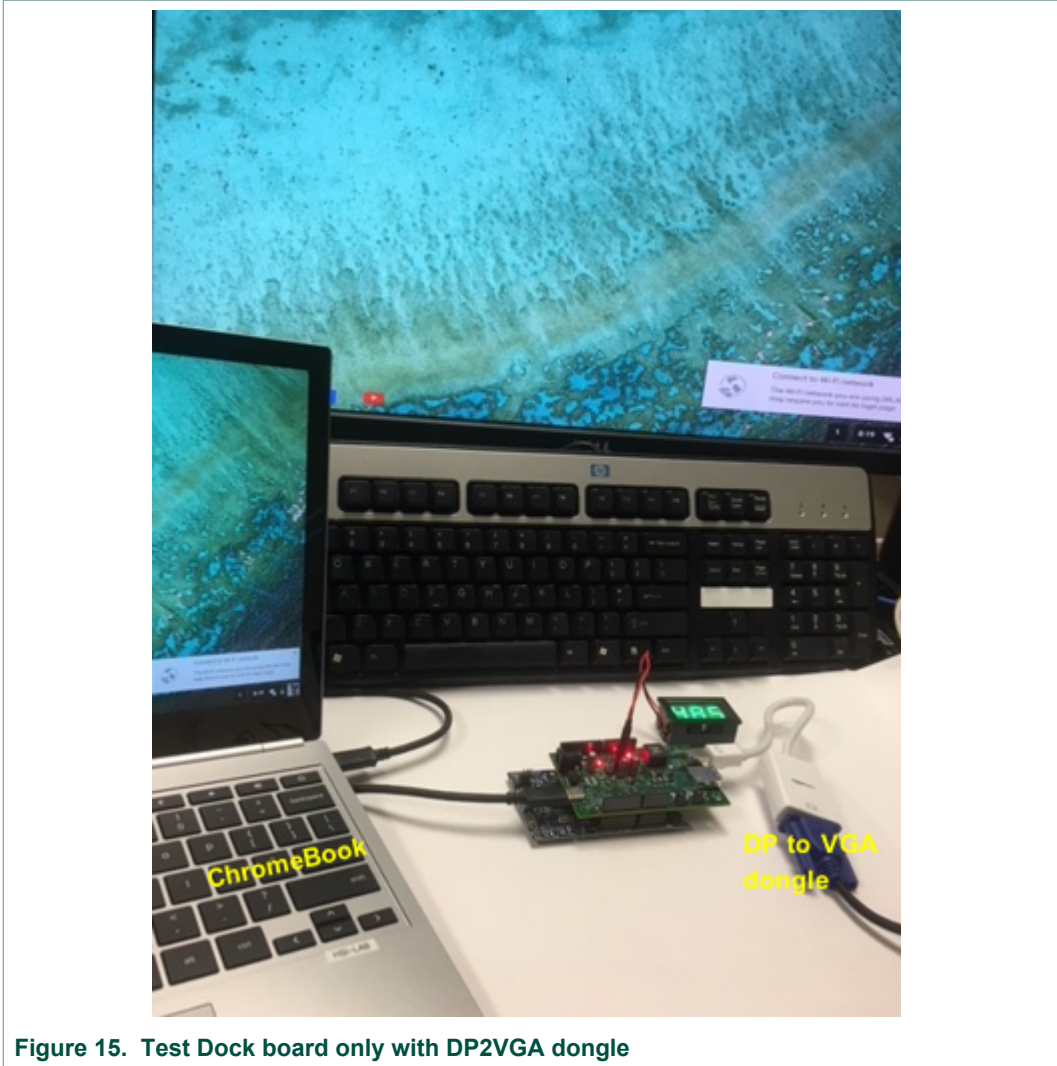

Figure 15. Test Dock board only with DP2VGA dongle

6 Component list

1. NXP USB PD Shield 2 Type-C HOST demo board
2. NXP USB PD Shield 2 Type-C DOCK demo board
3. Voltmeter (**DROK® Small Little DC Digital Voltmeter 3-30V**)
4. Universal Variable **9V ACDC adapter**

7 Shield 2 Type-C Demo Boards – Errata list

7.1 Errata list

Table 3. Errata list

	Errata List	Host Power Role	Dock Power Role	Demo System Impact	Solution
None					

8 Legal information

8.1 Definitions

Draft — The document is a draft version only. The content is still under internal review and subject to formal approval, which may result in modifications or additions. NXP Semiconductors does not give any representations or warranties as to the accuracy or completeness of information included herein and shall have no liability for the consequences of use of such information.

8.2 Disclaimers

Limited warranty and liability — Information in this document is believed to be accurate and reliable. However, NXP Semiconductors does not give any representations or warranties, expressed or implied, as to the accuracy or completeness of such information and shall have no liability for the consequences of use of such information. NXP Semiconductors takes no responsibility for the content in this document if provided by an information source outside of NXP Semiconductors. In no event shall NXP Semiconductors be liable for any indirect, incidental, punitive, special or consequential damages (including - without limitation - lost profits, lost savings, business interruption, costs related to the removal or replacement of any products or rework charges) whether or not such damages are based on tort (including negligence), warranty, breach of contract or any other legal theory. Notwithstanding any damages that customer might incur for any reason whatsoever, NXP Semiconductors' aggregate and cumulative liability towards customer for the products described herein shall be limited in accordance with the Terms and conditions of commercial sale of NXP Semiconductors.

Right to make changes — NXP Semiconductors reserves the right to make changes to information published in this document, including without limitation specifications and product descriptions, at any time and without notice. This document supersedes and replaces all information supplied prior to the publication hereof.

Suitability for use — NXP Semiconductors products are not designed, authorized or warranted to be suitable for use in life support, life-critical or safety-critical systems or equipment, nor in applications where failure or malfunction of an NXP Semiconductors product can reasonably be expected to result in personal injury, death or severe property or environmental damage. NXP Semiconductors and its suppliers accept no liability for inclusion and/or use of NXP Semiconductors products in such equipment or applications and therefore such inclusion and/or use is at the customer's own risk.

Applications — Applications that are described herein for any of these products are for illustrative purposes only. NXP Semiconductors makes no representation or warranty that such applications will be suitable for the specified use without further testing or modification. Customers are responsible for the design and operation of their applications and

products using NXP Semiconductors products, and NXP Semiconductors accepts no liability for any assistance with applications or customer product design. It is customer's sole responsibility to determine whether the NXP Semiconductors product is suitable and fit for the customer's applications and products planned, as well as for the planned application and use of customer's third party customer(s). Customers should provide appropriate design and operating safeguards to minimize the risks associated with their applications and products. NXP Semiconductors does not accept any liability related to any default, damage, costs or problem which is based on any weakness or default in the customer's applications or products, or the application or use by customer's third party customer(s). Customer is responsible for doing all necessary testing for the customer's applications and products using NXP Semiconductors products in order to avoid a default of the applications and the products or of the application or use by customer's third party customer(s). NXP does not accept any liability in this respect.

Export control — This document as well as the item(s) described herein may be subject to export control regulations. Export might require a prior authorization from competent authorities.

Evaluation products — This product is provided on an "as is" and "with all faults" basis for evaluation purposes only. NXP Semiconductors, its affiliates and their suppliers expressly disclaim all warranties, whether express, implied or statutory, including but not limited to the implied warranties of non-infringement, merchantability and fitness for a particular purpose. The entire risk as to the quality, or arising out of the use or performance, of this product remains with customer. In no event shall NXP Semiconductors, its affiliates or their suppliers be liable to customer for any special, indirect, consequential, punitive or incidental damages (including without limitation damages for loss of business, business interruption, loss of use, loss of data or information, and the like) arising out of the use of or inability to use the product, whether or not based on tort (including negligence), strict liability, breach of contract, breach of warranty or any other theory, even if advised of the possibility of such damages. Notwithstanding any damages that customer might incur for any reason whatsoever (including without limitation, all damages referenced above and all direct or general damages), the entire liability of NXP Semiconductors, its affiliates and their suppliers and customer's exclusive remedy for all of the foregoing shall be limited to actual damages incurred by customer based on reasonable reliance up to the greater of the amount actually paid by customer for the product or five dollars (US\$5.00). The foregoing limitations, exclusions and disclaimers shall apply to the maximum extent permitted by applicable law, even if any remedy fails of its essential purpose.

Translations — A non-English (translated) version of a document is for reference only. The English version shall prevail in case of any discrepancy between the translated and English versions.

8.3 Trademarks

Notice: All referenced brands, product names, service names and trademarks are the property of their respective owners.

Tables

Tab. 1. Connectors jumper setting list 8 Tab. 3. Errata list 22
Tab. 2. LED table 8

Figures

Fig. 1.	Shield 2 host board block diagram	4	Fig. 8.	Shield 2 demo setup picture	10
Fig. 2.	Shield 2 dock board block diagram	5	Fig. 9.	Shield 2 host board control and LED indication	11
Fig. 3.	Shield 2 host board connectors and jumpers location	6	Fig. 10.	Shield 2 dock board control and LED indication	11
Fig. 4.	Shield 2 host board connectors and jumpers example	6	Fig. 11.	Shield 2 demo system	13
Fig. 5.	Shield 2 dock board connectors and jumpers location	7	Fig. 12.	Sink menu	14
Fig. 6.	Shield 2 dock board connectors and jumpers example	7	Fig. 13.	Shield 2 DP ALT mode video play demo	16
Fig. 7.	Shield 2 demo kit hardware setup	9	Fig. 14.	Test host board only with Type-C_VGA dongle (left)	18
			Fig. 15.	Test Dock board only with DP2VGA dongle	20

Contents

1	Introduction	3
1.1	Purposes	3
2	General description	4
2.1	Block diagram	4
2.1.1	Shield 2 host board	4
2.1.2	Shield 2 dock board	5
2.2	Connectors and jumpers	5
2.2.1	Shield 2 host board connectors and jumpers location	6
2.2.2	Shield 2 dock board connectors and jumpers location	7
2.2.3	Connectors list	7
2.2.4	Connectors and jumper setting table	8
2.2.5	LED table	8
3	Hardware setup	9
3.1	Shield 2 demo setup picture	10
3.2	Shield 2 host board control and LED indication	11
3.3	Shield 2 dock board control and LED indication	11
3.4	Hardware setup procedure	11
3.4.1	Shield 2 host board	12
3.4.2	Shield 2 dock board	12
3.4.3	Shield 2 demo system	12
3.5	Shield 2 power sink request 5v, 9v from shield 2 power source board	13
3.6	USB PD DP alternate mode	14
3.7	USB PD DP alternate mode video play demo ...	15
4	Test shield 2 host board only	17
4.1	Use Type-C to HDMI/VGA dongles to verify host board	17
5	Test shield 2 dock board only	19
5.1	Use mini-DP to VGA Dongle to verify Dock Board	19
6	Component list	21
7	Shield 2 Type-C Demo Boards – Errata list	22
7.1	Errata list	22
8	Legal information	23

Please be aware that important notices concerning this document and the product(s) described herein, have been included in section 'Legal information'.

© NXP B.V. 2018.

All rights reserved.

For more information, please visit: <http://www.nxp.com>

For sales office addresses, please send an email to: salesaddresses@nxp.com

Date of release: 18 October 2018

Document identifier: UM11055



Компания «ЭлектроПласт» предлагает заключение долгосрочных отношений при поставках импортных электронных компонентов на взаимовыгодных условиях!

Наши преимущества:

- Оперативные поставки широкого спектра электронных компонентов отечественного и импортного производства напрямую от производителей и с крупнейших мировых складов;
- Поставка более 17-ти миллионов наименований электронных компонентов;
- Поставка сложных, дефицитных, либо снятых с производства позиций;
- Оперативные сроки поставки под заказ (от 5 рабочих дней);
- Экспресс доставка в любую точку России;
- Техническая поддержка проекта, помощь в подборе аналогов, поставка прототипов;
- Система менеджмента качества сертифицирована по Международному стандарту ISO 9001;
- Лицензия ФСБ на осуществление работ с использованием сведений, составляющих государственную тайну;
- Поставка специализированных компонентов (Xilinx, Altera, Analog Devices, Intersil, Interpoint, Microsemi, Aeroflex, Peregrine, Syfer, Eurofarad, Texas Instrument, Miteq, Cobham, E2V, MA-COM, Hittite, Mini-Circuits, General Dynamics и др.);

Помимо этого, одним из направлений компании «ЭлектроПласт» является направление «Источники питания». Мы предлагаем Вам помощь Конструкторского отдела:

- Подбор оптимального решения, техническое обоснование при выборе компонента;
- Подбор аналогов;
- Консультации по применению компонента;
- Поставка образцов и прототипов;
- Техническая поддержка проекта;
- Защита от снятия компонента с производства.



Как с нами связаться

Телефон: 8 (812) 309 58 32 (многоканальный)

Факс: 8 (812) 320-02-42

Электронная почта: org@eplast1.ru

Адрес: 198099, г. Санкт-Петербург, ул. Калинина, дом 2, корпус 4, литера А.