



GaAs pHEMT MMIC 3 WATT POWER AMPLIFIER SMT WITH POWER DETECTOR, 12 - 16 GHz

Typical Applications

The HMC995LP5GE is ideal for:

- Point-to-Point Radios
- Point-to-Multi-Point Radios
- VSAT & SATCOM
- Military & Space

Features

- Integrated Power Detector
- Saturated Output Power: 35.5 dBm @ 24% PAE
- High Output IP3: 41 dBm
- High Gain: 27 dB
- DC Supply: +5V to +7V @ 1200 mA
- No External Matching Required

Functional Diagram

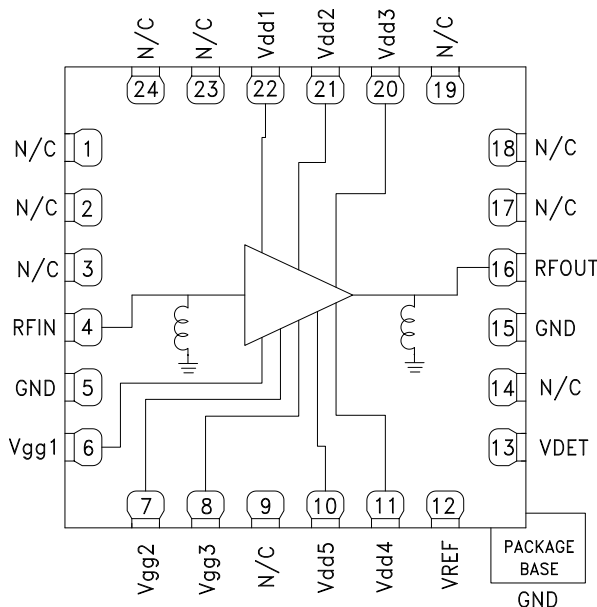

General Description

The HMC995LP5GE is a 4 stage GaAs pHEMT MMIC 2 Watt Power Amplifier with an integrated temperature compensated on-chip power detector which operates between 12 and 16 GHz. The HMC995LP5GE provides 27 dB of gain, 35.5 dBm of saturated output power, and 24% PAE from a +7V supply. The HMC995LP5GE exhibits excellent linearity and is optimized for high capacity digital microwave radio. It is also ideal for 13.75 to 14.5 GHz Ku Band VSAT transmitters as well as SATCOM applications. The HMC995LP5GE amplifier I/Os are internally matched to 50 Ohms and is packaged in a leadless QFN 5x5 mm surface mount package and requires no external matching components.

Electrical Specifications

$T_A = +25^\circ C$, $V_{dd} = V_{dd1} = V_{dd2} = V_{dd3} = V_{dd4} = V_{dd5} = +7V$, $I_{dd} = 1200 mA$ [1]

Parameter	Min.	Typ.	Max.	Units
Frequency Range	12 - 16			GHz
Gain [3]	24	27		dB
Gain Variation Over Temperature		0.03		dB/ °C
Input Return Loss		9		dB
Output Return Loss		15		dB
Output Power for 1 dB Compression (P1dB)	32	34.5		dBm
Saturated Output Power (P _{sat})		35.5		dBm
Output Third Order Intercept (IP3) ^[2]		41		dBm
Total Supply Current (I _{dd})		1200		mA

[1] Adjust (V_{gg1}=V_{gg2}=V_{gg3}) between -2 to 0V to achieve I_{dd} = 1200mA typical.

[2] Measurement taken at +7V @ 1200mA, P_{out} / Tone = +22 dBm

[3] Board loss subtracted out



GaAs pHEMT MMIC 3 WATT POWER AMPLIFIER SMT WITH POWER DETECTOR, 12 - 16 GHz

Broadband Gain & Return Loss vs. Frequency

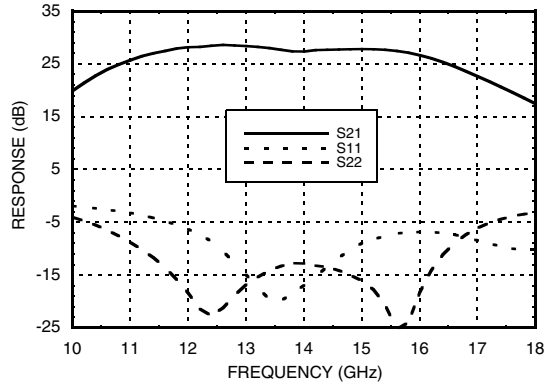

Gain vs. Temperature [1]

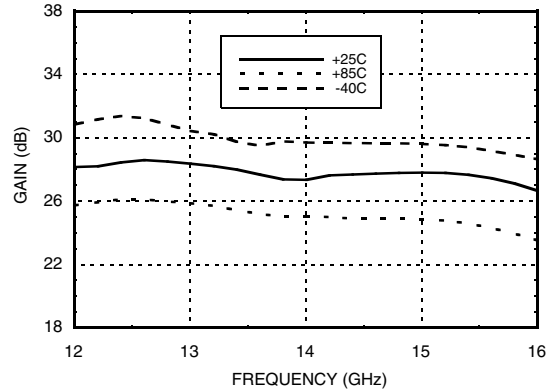

Input Return Loss vs. Temperature

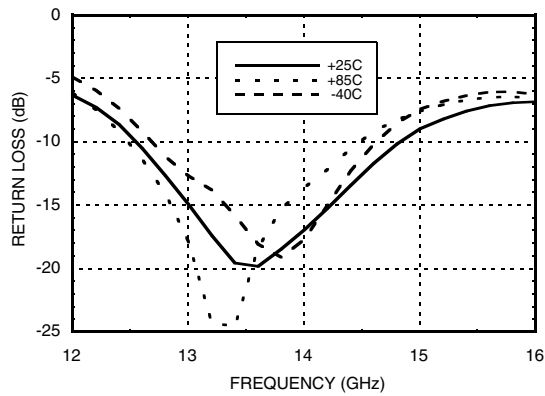

Output Return Loss vs. Temperature

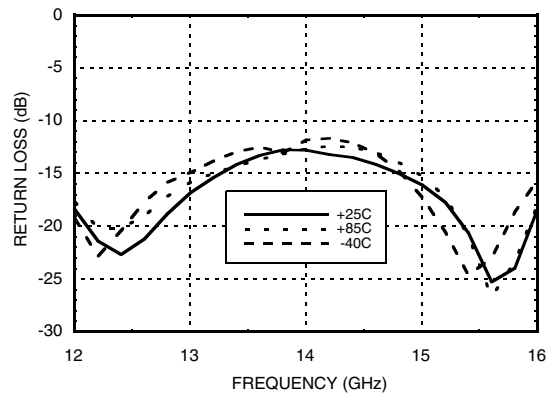

P1dB vs. Temperature

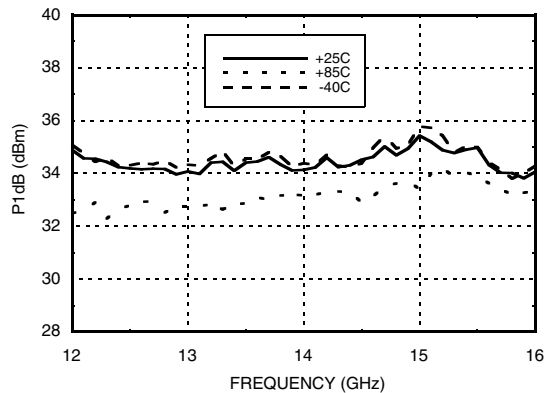

P1dB vs. Supply Voltage

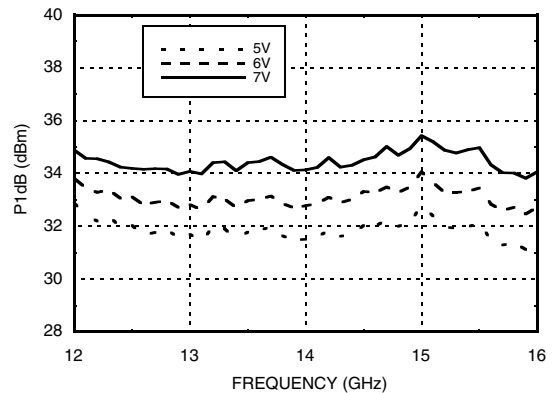

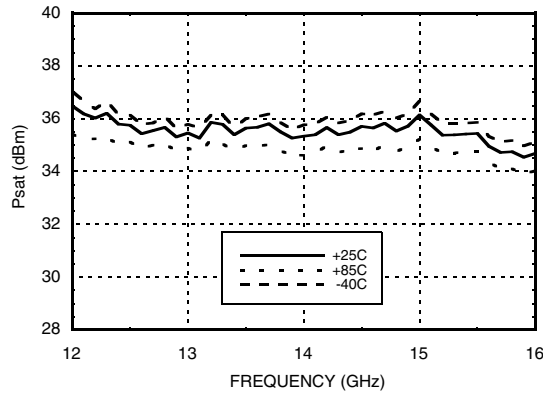
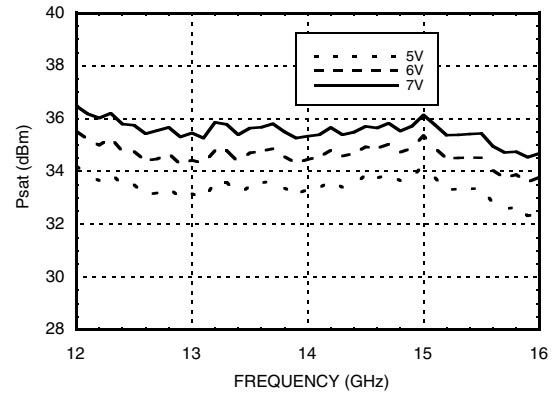
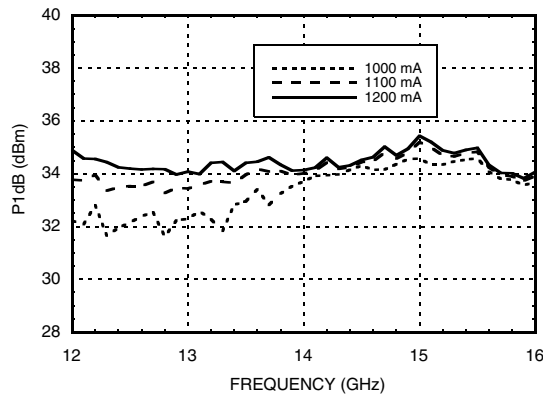
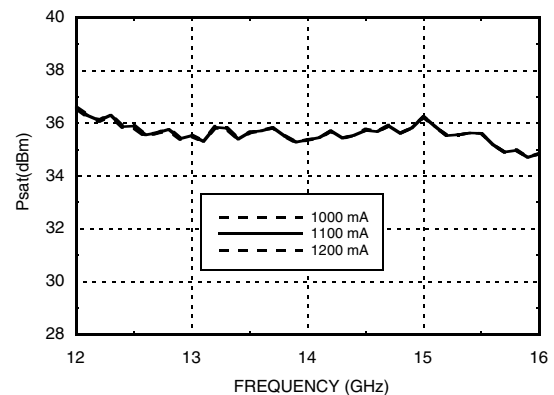
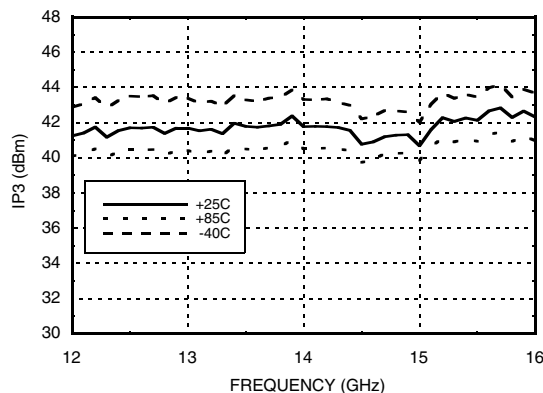
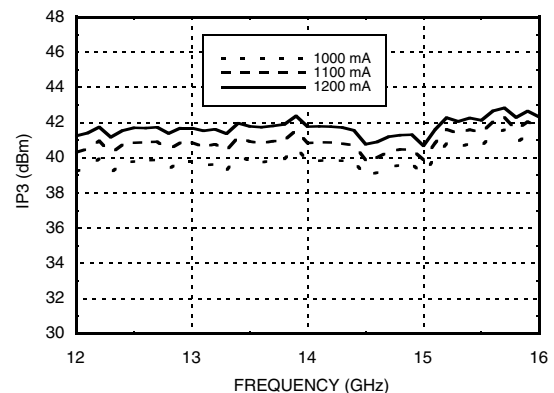

**GaAs pHEMT MMIC 3 WATT POWER AMPLIFIER SMT
WITH POWER DETECTOR, 12 - 16 GHz**
Psat vs. Temperature

Psat vs. Supply Voltage

P1dB vs. Supply Current (Idd)

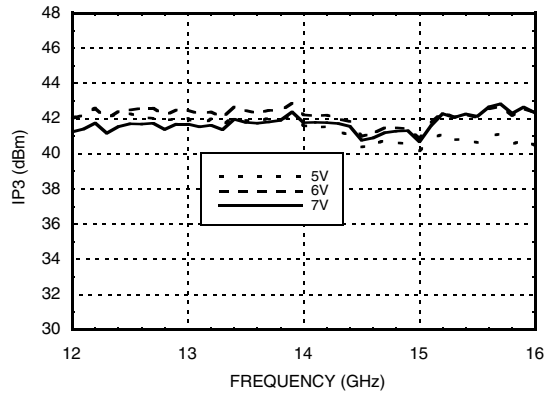
Psat vs. Supply Current (Idd)

Output IP3 vs. Temperature, Pout/Tone = +22 dBm

Output IP3 vs. Supply Current, Pout/Tone = +22 dBm



GaAs pHEMT MMIC 3 WATT POWER AMPLIFIER SMT WITH POWER DETECTOR, 12 - 16 GHz

**Output IP3 vs.
Supply Voltage, Pout/Tone = +22 dBm**



Output IM3 @ Vdd = +5V

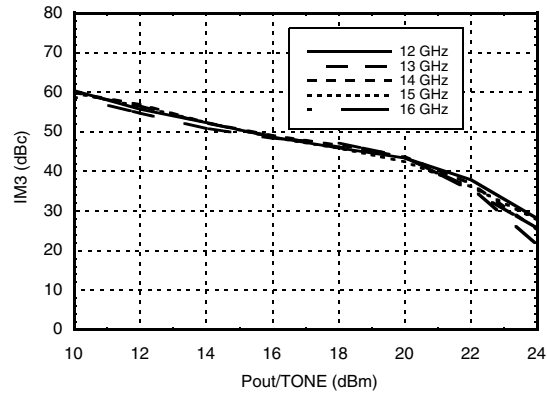

Output IM3 @ Vdd = +6V

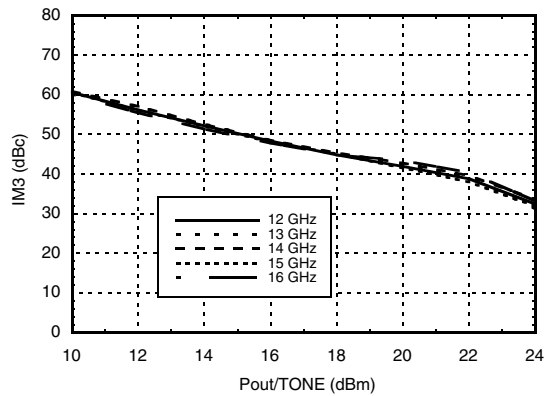

Output IM3 @ Vdd = +7V

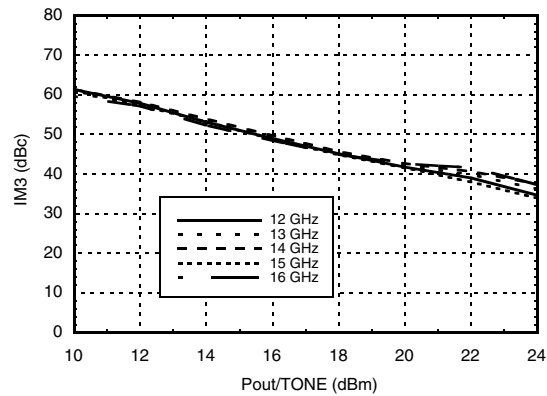

Power Compression @ 13 GHz

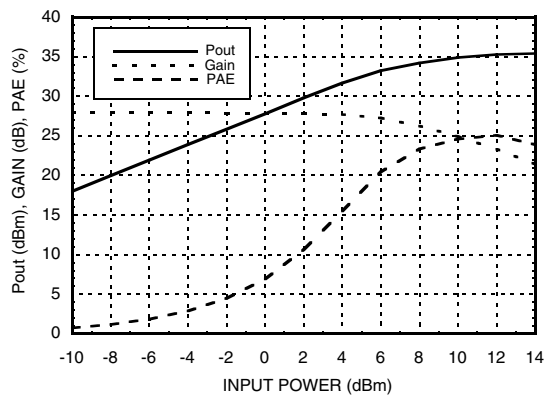

Power Compression @ 15 GHz

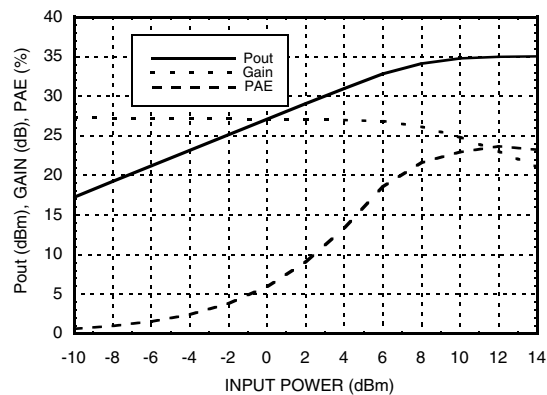



GaAs pHEMT MMIC 3 WATT POWER AMPLIFIER SMT WITH POWER DETECTOR, 12 - 16 GHz

Detector Voltage vs. Frequency & Temperature

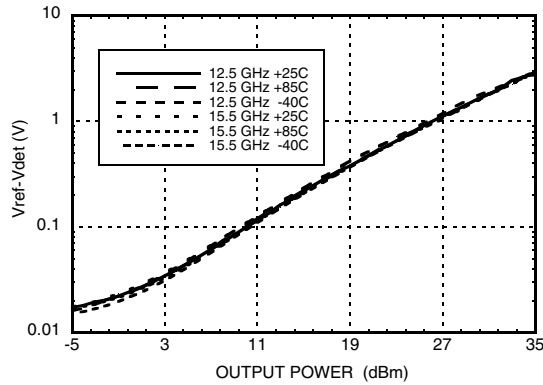

Reverse isolation vs. Temperature

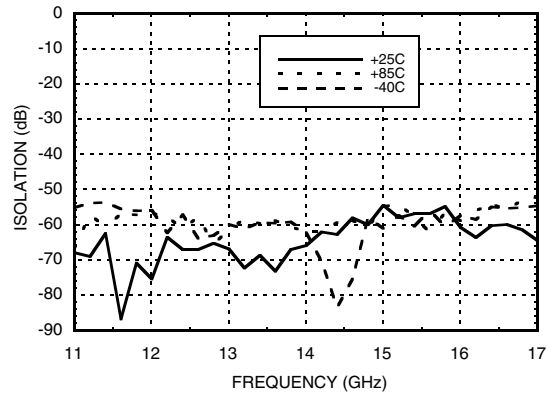

Gain & Power vs. Supply Current @ 14 GHz

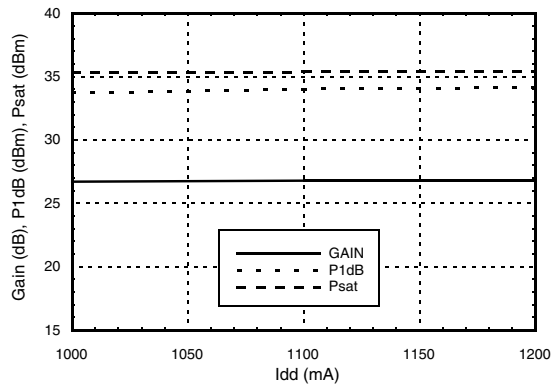

Gain & Power vs. Supply Voltage @ 14 GHz

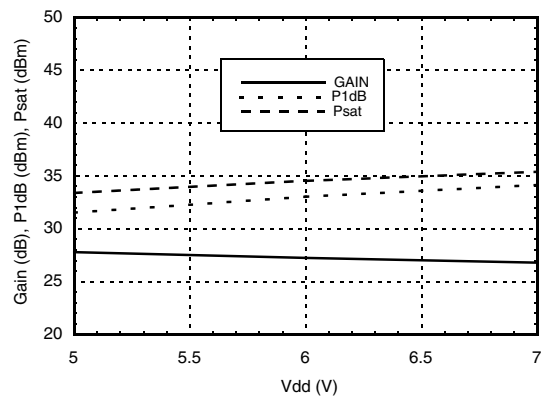

Power Dissipation

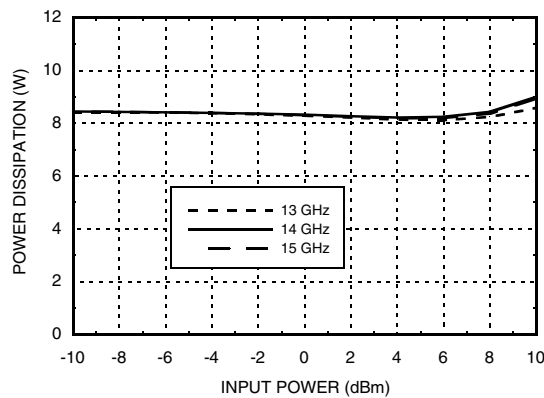

**GaAs pHEMT MMIC 3 WATT POWER AMPLIFIER SMT
WITH POWER DETECTOR, 12 - 16 GHz****Absolute Maximum Ratings**

Drain Bias Voltage (Vdd1-5)	+8V
RF Input Power (RFIN)	+24 dBm
Channel Temperature	150 °C
Continuous P _{diss} (T= 85 °C) (derate 137 mW/°C above 85 °C)	8.9 W
Thermal Resistance (channel to gnd paddle)	7.3 °C/W
Storage Temperature	-65 to +150 °C
Operating Temperature	-40 to +85 °C
ESD Sensitivity (HBM)	Class 1A

Typical Supply Current vs. Vdd

Vdd (V)	I _{dd} (mA)
5	1200
6	1200
7	1200

Note: Amplifier will operate over full voltage ranges shown above V_{gg} adjusted to achieve I_{dd} = 1200 mA



ELECTROSTATIC SENSITIVE DEVICE
OBSERVE HANDLING PRECAUTIONS



GaAs pHEMT MMIC 3 WATT POWER AMPLIFIER SMT WITH POWER DETECTOR, 12 - 16 GHz

Outline Drawing

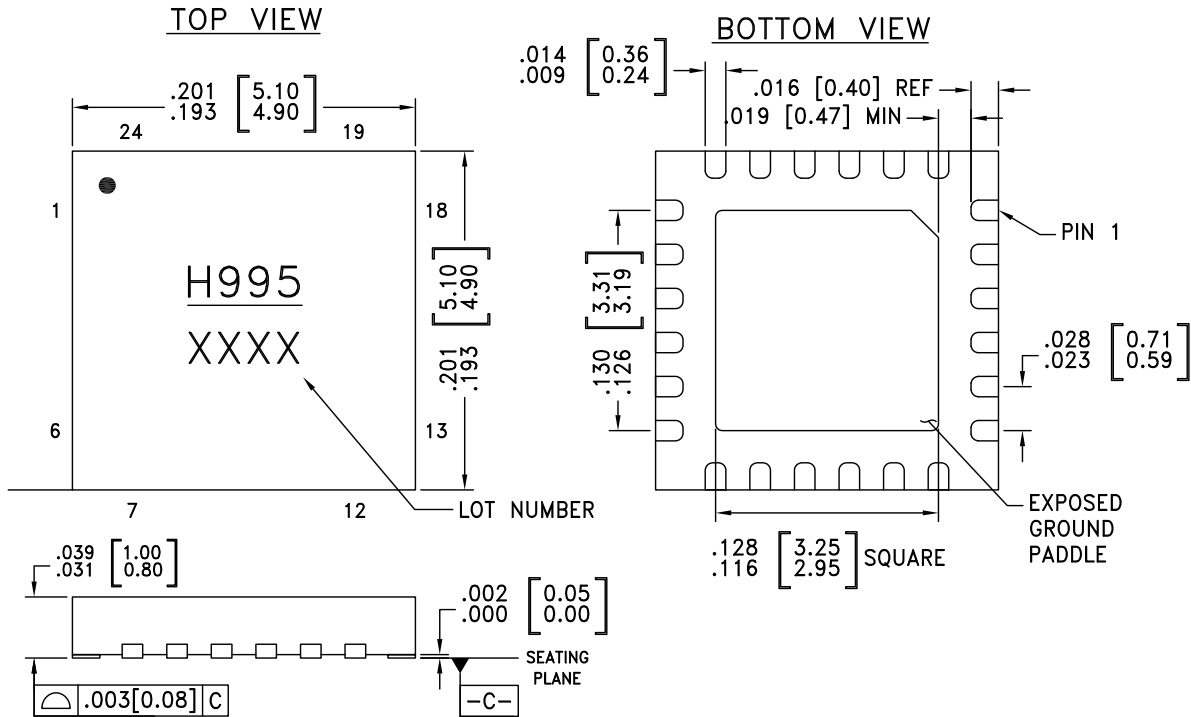

NOTES:

1. PACKAGE BODY MATERIAL: ALUMINA
2. LEAD AND GROUND PADDLE PLATING: 30-80 MICROINCHES GOLD OVER 50 MICROINCHES MINIMUM NICKEL.
3. DIMENSIONS ARE IN INCHES [MILLIMETERS].
4. LEAD SPACING TOLERANCE IS NON-CUMULATIVE
5. PACKAGE WARP SHALL NOT EXCEED 0.05mm DATUM -C-
6. ALL GROUND LEADS AND GROUND PADDLE MUST BE SOLDERED TO PCB RF GROUND.

Package Information

Part Number	Package Body Material	Lead Finish	MSL Rating	Package Marking ^[1]
HMC995LP5GE	RoHS-compliant Low Stress Injection Molded Plastic	100% matte Sn	MSL3 ^[2]	H995 XXXX



[1] 4-Digit lot number XXXX

[2] Max peak reflow temperature of 260 °C

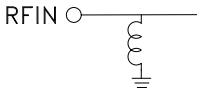

GaAs pHEMT MMIC 3 WATT POWER AMPLIFIER SMT WITH POWER DETECTOR, 12 - 16 GHz

Pin Descriptions

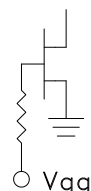
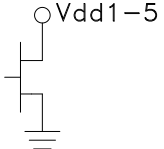
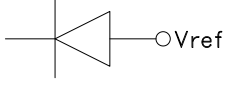
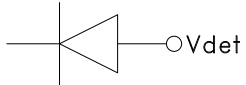
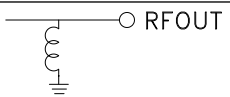
Pin Number	Function	Description	Interface Schematic
1-3, 9, 14 17-19, 23, 24	N/C	These pins are not connected internally, however all data shown herein was measured with these pins connected to RF/DC ground externally.	
4	RFIN	This pad is DC coupled and matched to 50 Ohms.	
5, 15	GND	These pins and package bottom must be connected to RF/DC ground.	
6-8	Vgg1, Vgg2 Vgg3	Gate control for amplifier. External bypass capacitors of 100pF, 10nF and 4.7uF are required. Please follow "MMIC Amplifier Biasing Procedure" App Note.	
10, 11 20-22	Vdd1, Vdd2, Vdd3, Vdd4, Vdd5	Drain bias voltage for the amplifier. External bypass capacitors of 100pF, 10nF and 4.7uF capacitors are required.	
12	Vref	DC voltage of diode biased through external resistor, used for temperature compensation of Vdet. See Application Circuit.	
13	Vdet	DC voltage representing RF output power rectified by diode which is biased through an external resistor. See Application Circuit.	
16	RFOUT	This pin is DC coupled and matched to 50 Ohms.	



GaAs pHEMT MMIC 3 WATT POWER AMPLIFIER SMT WITH POWER DETECTOR, 12 - 16 GHz

Application Circuit

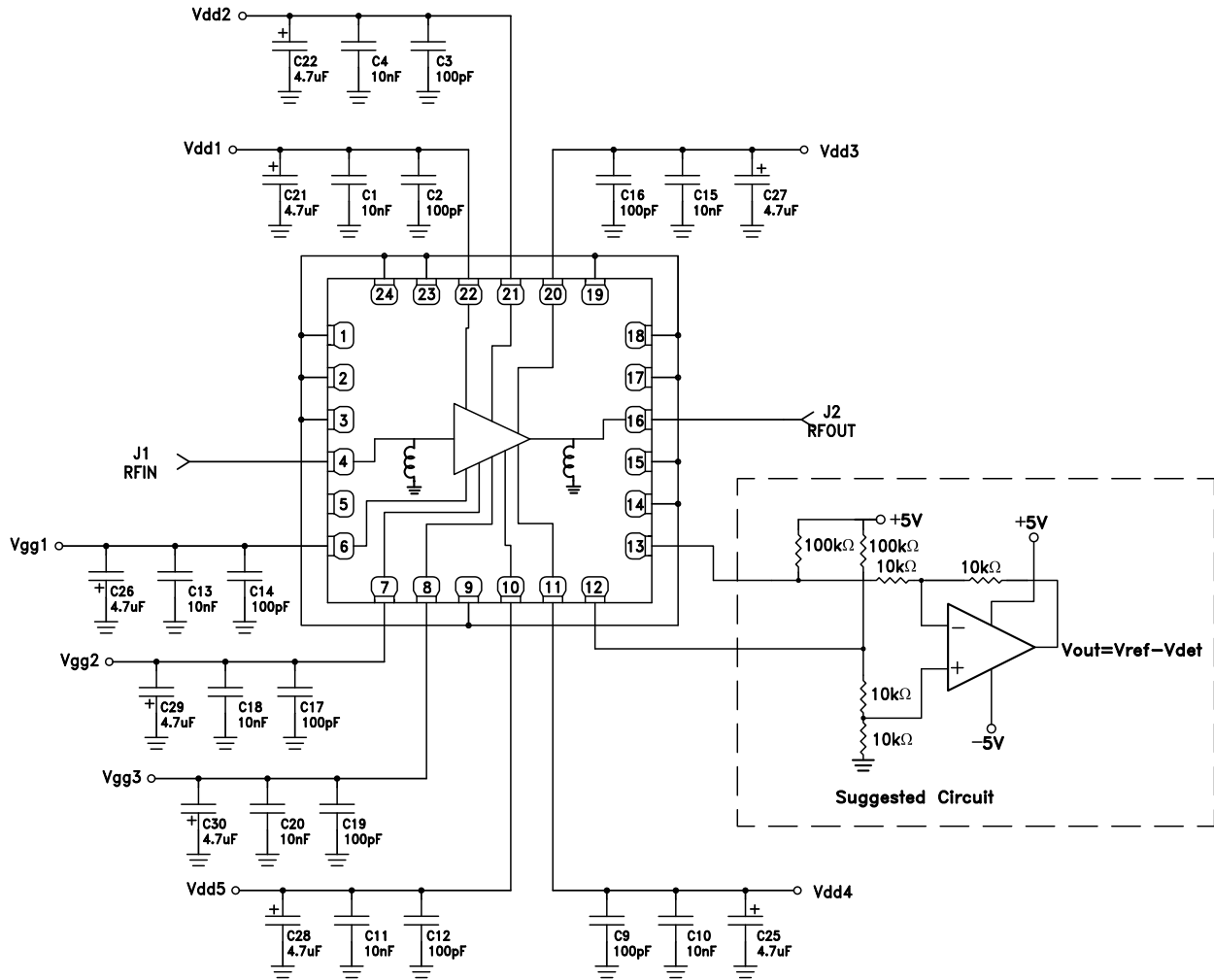

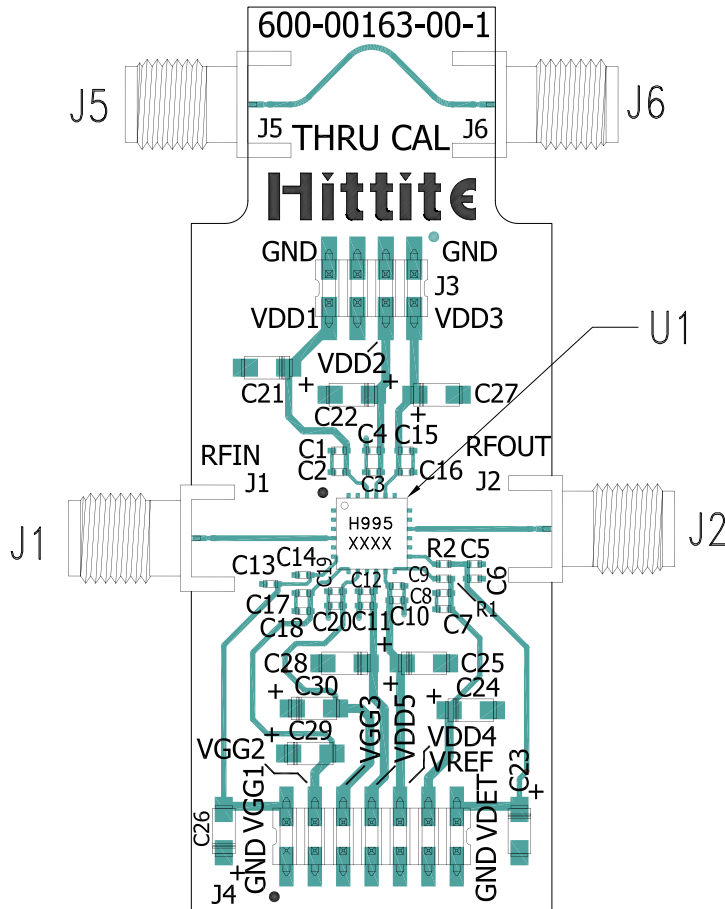
**GaAs pHEMT MMIC 3 WATT POWER AMPLIFIER SMT
WITH POWER DETECTOR, 12 - 16 GHz**
Evaluation PCB

List of Materials for Evaluation PCB EVAL01-HMC995LP5GE [1]

Item	Description
J1, J2, J5, J6	K Connector SRI
J3, J4	DC Pin
C2, C3, C9, C12, C14, C16, C17, C19	100 pF Capacitor, 0402 Pkg.
C1, C4, C10, C11, C13, C15, C18, C20	10 nF Capacitor, 0402 Pkg.
C21, C22, C25 - C30	4.7uF Capacitor, Case A.
U1	HMC995LP5GE Power Amplifier
PCB	600-00163-00 Evaluation PCB

[1] Reference this number when ordering complete evaluation PCB

[2] Circuit Board Material: Rogers 4350 or Arlon FR4

The circuit board used in the application should use RF circuit design techniques. Signal lines should have 50 Ohm impedance while the package ground leads and exposed paddle should be connected directly to the ground plane similar to that shown. A sufficient number of via holes should be used to connect the top and bottom ground planes. The evaluation board should be mounted to an appropriate heat sink. The evaluation circuit board shown is available from Hittite upon request.



Компания «ЭлектроПласт» предлагает заключение долгосрочных отношений при поставках импортных электронных компонентов на взаимовыгодных условиях!

Наши преимущества:

- Оперативные поставки широкого спектра электронных компонентов отечественного и импортного производства напрямую от производителей и с крупнейших мировых складов;
- Поставка более 17-ти миллионов наименований электронных компонентов;
- Поставка сложных, дефицитных, либо снятых с производства позиций;
- Оперативные сроки поставки под заказ (от 5 рабочих дней);
- Экспресс доставка в любую точку России;
- Техническая поддержка проекта, помощь в подборе аналогов, поставка прототипов;
- Система менеджмента качества сертифицирована по Международному стандарту ISO 9001;
- Лицензия ФСБ на осуществление работ с использованием сведений, составляющих государственную тайну;
- Поставка специализированных компонентов (Xilinx, Altera, Analog Devices, Intersil, Interpoint, Microsemi, Aeroflex, Peregrine, Syfer, Eurofarad, Texas Instrument, Miteq, Cobham, E2V, MA-COM, Hittite, Mini-Circuits, General Dynamics и др.);

Помимо этого, одним из направлений компании «ЭлектроПласт» является направление «Источники питания». Мы предлагаем Вам помощь Конструкторского отдела:

- Подбор оптимального решения, техническое обоснование при выборе компонента;
- Подбор аналогов;
- Консультации по применению компонента;
- Поставка образцов и прототипов;
- Техническая поддержка проекта;
- Защита от снятия компонента с производства.



Как с нами связаться

Телефон: 8 (812) 309 58 32 (многоканальный)

Факс: 8 (812) 320-02-42

Электронная почта: org@eplast1.ru

Адрес: 198099, г. Санкт-Петербург, ул. Калинина, дом 2, корпус 4, литера А.