

# LDA10F

LDA 10 F -5 -□

① ② ③ ④ ⑤



Recommended EMI/EMC Filter  
NAC-06-472



High voltage pulse noise type : NAP series  
Low leakage current type : NAM series  
\*The EMI/EMC Filter is recommended to connect with several devices.

- ① Series name
- ② Output wattage
- ③ Universal input
- ④ Output voltage
- ⑤ Optional \*2
- C : with Coating
- G : Low leakage current
- S : with Chassis
- SN : with Chassis & cover
- Y : with Potentiometer

MODEL	LDA10F-3	LDA10F-5	LDA10F-12	LDA10F-15	LDA10F-24
MAX OUTPUT WATTAGE[W]	6	10	10.8	10.5	12
DC OUTPUT	3V 2.0A	5V 2.0A	12V 0.9A	15V 0.7A	24V 0.5A

## SPECIFICATIONS

MODEL		LDA10F-3	LDA10F-5	LDA10F-12	LDA10F-15	LDA10F-24	
INPUT	VOLTAGE[V]	AC85 - 264 1 φ or DC110 - 370					
	CURRENT[A]	ACIN 100V	0.25typ (Io=100%)				
		ACIN 200V	0.16typ (Io=100%)				
	FREQUENCY[Hz]	47 - 440 or DC					
	EFFICIENCY[%]	68typ	72typ	74typ	74typ	78typ	
	INRUSH CURRENT[A]	ACIN 100V	15typ (Io=100%) (At cold start)				
		ACIN 200V	30typ (Io=100%) (At cold start)				
LEAKAGE CURRENT[mA]	0.75max (60Hz, According to UL, CSA, VDE and DEN-AN)						
OUTPUT	VOLTAGE[V]	3	5	12	15	24	
	CURRENT[A]	2	2	0.9	0.7	0.5	
	LINE REGULATION[mV]	20max	20max	48max	60max	96max	
	LOAD REGULATION[mV]	40max	40max	100max	120max	150max	
	RIPPLE[mVp-p]	0 to +50°C	80max	80max	120max	120max	120max
		-10 - 0°C	140max	140max	160max	160max	160max
	RIPPLE NOISE[mVp-p]	0 to +50°C	120max	120max	150max	150max	150max
		-10 - 0°C	160max	160max	180max	180max	180max
	TEMPERATURE REGULATION[mV]	50max	50max	120max	150max	240max	
	DRIFT[mV]	*1 20max	20max	48max	60max	96max	
	START-UP TIME[ms]	200max (ACIN 100V, Io=100%)					
	HOLD-UP TIME[ms]	10typ (ACIN 85V, Io=100%) 20typ (ACIN 100V, Io=100%) 100typ (ACIN 200V, Io=100%)					
	OUTPUT VOLTAGE ADJUSTMENT RANGE[V]	2.85 - 3.6	Fixed ("Y" which can be adjusted the output is available as option :5, 12, 15, 24V ±10%)				
OUTPUT VOLTAGE SETTING[V]	—	4.9 - 5.3	11.5 - 12.5	14.4 - 15.6	23.0 - 25.0		
PROTECTION CIRCUIT AND OTHERS	OVERCURRENT PROTECTION	Works over 105% of rating and recovers automatically					
	OVERVOLTAGE PROTECTION	4.00V min	Works over 115% of rating, by zener diode clamping				
	OPERATING INDICATION	Not provided					
	REMOTE SENSING	Not provided					
ISOLATION	REMOTE ON/OFF	Not provided					
	INPUT-OUTPUT	AC3.000V 1minute, Cutoff current = 10mA, DC500V 50MΩ min (At Room Temperature)					
	INPUT-FG	AC2.000V 1minute, Cutoff current = 10mA, DC500V 50MΩ min (At Room Temperature)					
ENVIRONMENT	OUTPUT-FG	AC500V 1minute, Cutoff current = 100mA, DC500V 50MΩ min (At Room Temperature)					
	OPERATING TEMP., HUMID. AND ALTITUDE	-10 to +60°C, 20 - 90%RH (Non condensing) (Refer to DERATING CURVE) 3.000m (10.000feet) max					
	STORAGE TEMP., HUMID. AND ALTITUDE	-20 to +75°C, 20 - 90%RH (Non condensing) 9.000m (30.000feet) max					
	VIBRATION	10 - 55Hz, 19.6m/s <sup>2</sup> (2G), 3minutes period, 60minutes each along X, Y and Z axis					
SAFETY AND NOISE REGULATIONS	IMPACT	196.1m/s <sup>2</sup> (20G), 11ms, once each X, Y and Z axis					
	AGENCY APPROVALS	UL60950-1, EN60950-1, EN50178, CSA C22.2 No.60950-1 Complies with DEN-AN and IEC60950-1					
	CONDUCTED NOISE	Complies with FCC-B, CISPR22-B, EN55022-B, VCCI-B					
OTHERS	CASE SIZE/WEIGHT	50 X 21 X 105mm (W X H X D) /75g max (without chassis and cover)					
	COOLING METHOD	Convection					

\*1 Drift is the change in DC output for an eight hour period after a half-hour warm-up at 25°C, with the input voltage held constant at the rated input/output.  
 \*2 Please contact us about safety approvals for the model with option.  
 \* Avoid prolonged use under over-load.  
 \* Series/Parallel operation with other model is not possible.  
 \* Derating is required when operated with chassis and cover.

## External view



I/O Connector	Mating Connector	Terminal
CN1	B3P5-VH	VHR-5N
		Chain:SVH-21T-P1.1
		Loose:BVH-21T-P1.1
CN2	B4B-XH-A	XHP-4
		Chain:SXH-001T-P0.6
		Loose:BXH-001T-P0.6

(Mir : J.S.T.)

### <PIN CONNECTION>

Pin No.	Input
1	AC(L)
2	
3	AC(N)
4	
5	FG

Pin No.	Output
1	-V
2	-V
3	+V
4	+V

※ Keep drawing current per pin below 2A for CN2.

- ※ Weight : 75g or less (Without chassis and cover)
- ※ Tolerance : ±1
- ※ Dimensions in mm.
- ※ PCB Material : Glass composite (CEM3)
- ※ Chassis and cover is optional.
- ※ Mounting torque : 0.6N·m (6.3kgf·cm) max

LDA

## Performance data

### ■ STATIC CHARACTERISTICS (LDA10F-5)

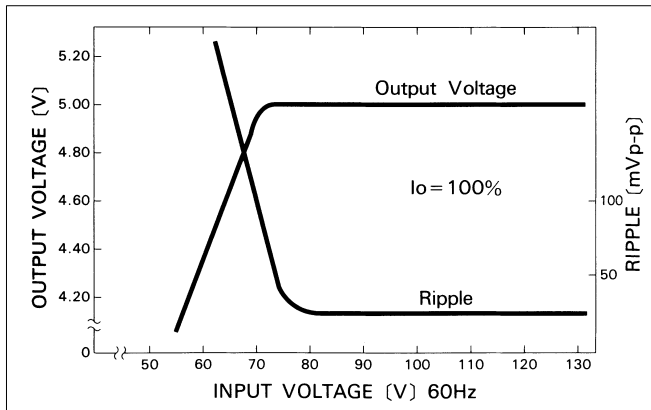

### ■ RISE TIME & FALL TIME (LDA10F-5)

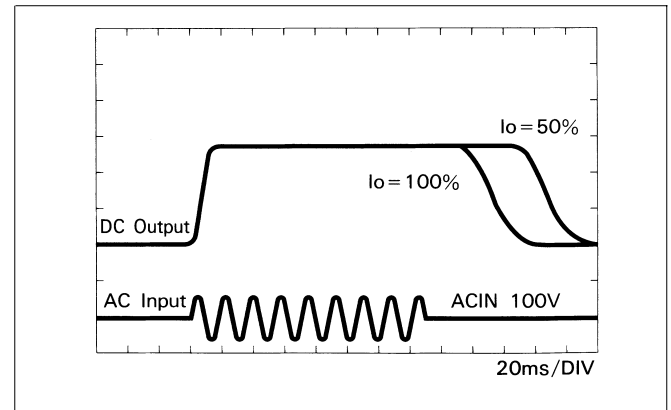

### ■ OVERCURRENT CHARACTERISTICS (LDA10F-5)



### ■ DERATING CURVE



# LDA15F

LDA 15 F -5 -□

① ② ③ ④ ⑤



Recommended EMI/EMC Filter  
NAC-06-472



High voltage pulse noise type : NAP series  
Low leakage current type : NAM series  
\*The EMI/EMC Filter is recommended to connect with several devices.

- ① Series name
- ② Output wattage
- ③ Universal input
- ④ Output voltage
- ⑤ Optional \*2
- C :with Coating
- G :Low leakage current
- S :with Chassis
- SN :with Chassis & cover
- Y :with Potentiometer



MODEL	LDA15F-3	LDA15F-5	LDA15F-12	LDA15F-15	LDA15F-24
MAX OUTPUT WATTAGE[W]	9	15	15.6	15	16.8
DC OUTPUT	3V 3.0A	5V 3.0A	12V 1.3A	15V 1.0A	24V 0.7A

## SPECIFICATIONS

	MODEL	LDA15F-3	LDA15F-5	LDA15F-12	LDA15F-15	LDA15F-24	
INPUT	VOLTAGE[V]	AC85 - 264 1 φ or DC110 - 370					
	CURRENT[A]	ACIN 100V	0.37typ (Io=100%)				
		ACIN 200V	0.23typ (Io=100%)				
	FREQUENCY[Hz]	47 - 440 or DC					
	EFFICIENCY[%]	70typ	74typ	76typ	76typ	78typ	
	INRUSH CURRENT[A]	ACIN 100V	15typ (Io=100%) (At cold start)				
		ACIN 200V	30typ (Io=100%) (At cold start)				
LEAKAGE CURRENT[mA]	0.75max (60Hz, According to UL, CSA, VDE and DEN-AN)						
OUTPUT	VOLTAGE[V]	3	5	12	15	24	
	CURRENT[A]	3	3	1.3	1	0.7	
	LINE REGULATION[mV]	20max	20max	48max	60max	96max	
	LOAD REGULATION[mV]	40max	40max	100max	120max	150max	
	RIPPLE[mVp-p]	0 to +50°C	80max	80max	120max	120max	120max
		-10 - 0°C	140max	140max	160max	160max	160max
	RIPPLE NOISE[mVp-p]	0 to +50°C	120max	120max	150max	150max	150max
		-10 - 0°C	160max	160max	180max	180max	180max
	TEMPERATURE REGULATION[mV]	50max	50max	120max	150max	240max	
	DRIFT[mV]	*1 20max	20max	48max	60max	96max	
	START-UP TIME[ms]	200max (ACIN 100V, Io=100%)					
	HOLD-UP TIME[ms]	10typ (ACIN 85V, Io=100%) 20typ (ACIN 100V, Io=100%) 100typ (ACIN 200V, Io=100%)					
	OUTPUT VOLTAGE ADJUSTMENT RANGE[V]	2.85 - 3.6	Fixed ("Y"which can be adjusted the output is available as option :5, 12, 15, 24V ±10%)				
OUTPUT VOLTAGE SETTING[V]	—	4.9 - 5.3	11.5 - 12.5	14.4 - 15.6	23.0 - 25.0		
PROTECTION CIRCUIT AND OTHERS	OVERCURRENT PROTECTION	Works over 105% of rating and recovers automatically					
	OVERVOLTAGE PROTECTION	4.00V min	Works over 115% of rating, by zener diode clamping				
	OPERATING INDICATION	Not provided					
	REMOTE SENSING	Not provided					
ISOLATION	REMOTE ON/OFF	Not provided					
	INPUT-OUTPUT	AC3.000V 1minute, Cutoff current = 10mA, DC500V 50MΩ min (At Room Temperature)					
	INPUT-FG	AC2.000V 1minute, Cutoff current = 10mA, DC500V 50MΩ min (At Room Temperature)					
ENVIRONMENT	OUTPUT-FG	AC500V 1minute, Cutoff current = 100mA, DC500V 50MΩ min (At Room Temperature)					
	OPERATING TEMP.,HUMID.AND ALTIITUDE	-10 to +60°C, 20 - 90%RH (Non condensing) (Refer to DERATING CURVE) 3.000m (10.000feet) max					
	STORAGE TEMP.,HUMID.AND ALTIITUDE	-20 to +75°C, 20 - 90%RH (Non condensing) 9.000m (30.000feet) max					
	VIBRATION	10 - 55Hz, 19.6m/s <sup>2</sup> (2G), 3minutes period, 60minutes each along X, Y and Z axis					
SAFETY AND NOISE REGULATIONS	IMPACT	196.1m/s <sup>2</sup> (20G), 11ms, once each X, Y and Z axis					
	AGENCY APPROVALS	UL60950-1, EN60950-1, EN50178, CSA C22.2 No.60950-1 Complies with DEN-AN and IEC60950-1					
	CONDUCTED NOISE	Complies with FCC-B, CISPR22-B, EN55022-B, VCCI-B					
OTHERS	CASE SIZE/WEIGHT	50 X 21 X 125mm (W X H X D) /95g max (without chassis and cover)					
	COOLING METHOD	Convection					

\*1 Drift is the change in DC output for an eight hour period after a half-hour warm-up at 25°C, with the input voltage held constant at the rated input/output.  
 \*2 Please contact us about safety approvals for the model with option.  
 \* Avoid prolonged use under over-load.  
 \* Series/Parallel operation with other model is not possible.  
 \* Derating is required when operated with chassis and cover.

## External view

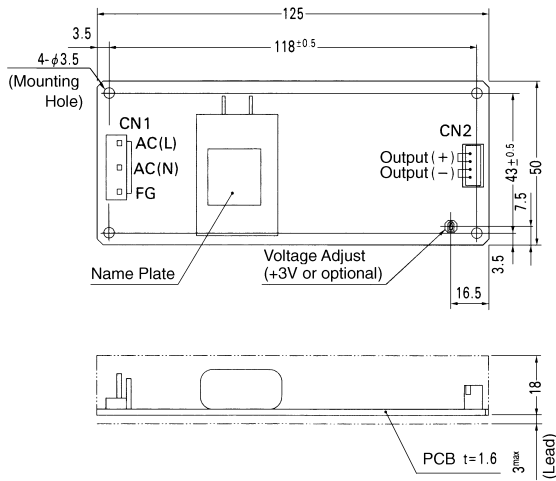

I/O Connector	Mating Connector	Terminal
CN1	B3P5-VH	VHR-5N
		Chain: SVH-21T-P1.1
		Loose: BVH-21T-P1.1
CN2	B4B-XH-A	XHP-4
		Chain: SXH-001T-P0.6
		Loose: BXH-001T-P0.6

(Mfr : J.S.T.)

### <PIN CONNECTION>

Pin No.	Input
1	AC(L)
2	AC(N)
3	AC(N)
4	AC(N)
5	FG

Pin No.	Output
1	-V
2	-V
3	+V
4	+V

- ※ Weight : 95g or less (Without chassis and cover)
- ※ Tolerance : ± 1
- ※ Dimensions in mm.
- ※ PCB Material : Glass composite (CEM3)
- ※ Chassis and cover is optional.
- ※ Mounting torque : 0.6N·m (6.3kgf·cm) max

## Performance data

### ■ STATIC CHARACTERISTICS (LDA15F-5)



### ■ RISE TIME & FALL TIME (LDA15F-5)



### ■ OVERCURRENT CHARACTERISTICS (LDA15F-5)

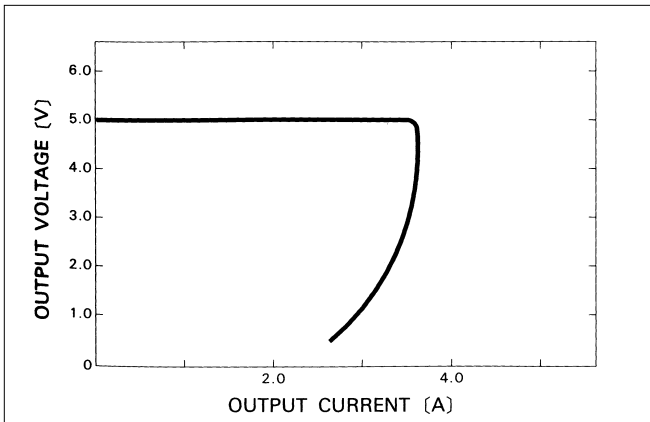

### ■ DERATING CURVE

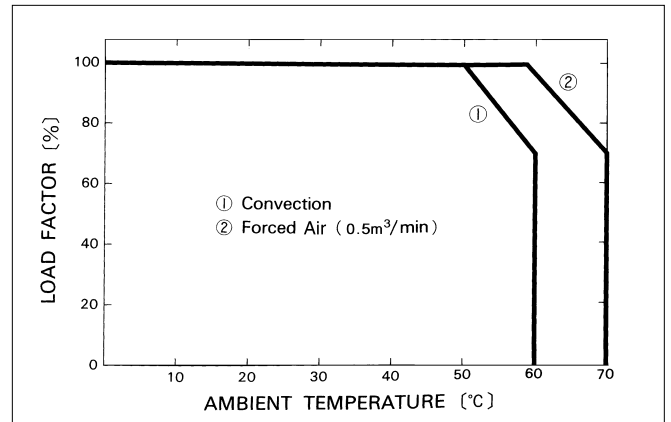

# LDA30F

LDA 30 F -5 -□

① ② ③ ④ ⑤



Recommended EMI/EMC Filter  
NAC-06-472



High voltage pulse noise type : NAP series  
Low leakage current type : NAM series  
\*The EMI/EMC Filter is recommended to connect with several devices.

- ① Series name
- ② Output wattage
- ③ Universal input
- ④ Output voltage
- ⑤ Optional \*2
- C :with Coating
- G :Low leakage current
- S :with Chassis
- SN :with Chassis & cover
- Y :with Potentiometer

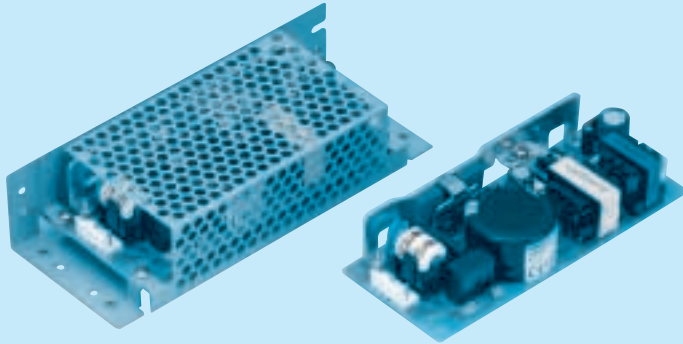

MODEL	LDA30F-3	LDA30F-5	LDA30F-12	LDA30F-15	LDA30F-24
MAX OUTPUT WATTAGE[W]	18	30	30	30	31.2
DC OUTPUT	3V 6.0A	5V 6.0A	12V 2.5A	15V 2.0A	24V 1.3A

## SPECIFICATIONS

	MODEL	LDA30F-3	LDA30F-5	LDA30F-12	LDA30F-15	LDA30F-24	
INPUT	VOLTAGE[V]	AC85 - 264 1 φ or DC110 - 370					
	CURRENT[A]	ACIN 100V	0.8typ (Io=100%)				
		ACIN 200V	0.4typ (Io=100%)				
	FREQUENCY[Hz]	47 - 440 or DC					
	EFFICIENCY[%]	70typ	75typ	77typ	78typ	79typ	
	INRUSH CURRENT[A]	ACIN 100V	15typ (Io=100%) (At cold start)				
		ACIN 200V	30typ (Io=100%) (At cold start)				
LEAKAGE CURRENT[mA]	0.75max (60Hz, According to UL, CSA, VDE and DEN-AN)						
OUTPUT	VOLTAGE[V]	3	5	12	15	24	
	CURRENT[A]	6	6	2.5	2	1.3	
	LINE REGULATION[mV]	20max	20max	48max	60max	96max	
	LOAD REGULATION[mV]	40max	40max	100max	120max	150max	
	RIPPLE[mVp-p]	0 to +50°C	80max	80max	120max	120max	120max
		-10 - 0°C	140max	140max	160max	160max	160max
	RIPPLE NOISE[mVp-p]	0 to +50°C	120max	120max	150max	150max	150max
		-10 - 0°C	160max	160max	180max	180max	180max
	TEMPERATURE REGULATION[mV]	60max	60max	150max	180max	290max	
	DRIFT[mV]	*1 20max	20max	48max	60max	96max	
	START-UP TIME[ms]	200max (ACIN 100V, Io=100%)					
	HOLD-UP TIME[ms]	10typ (ACIN 85V, Io=100%) 20typ (ACIN 100V, Io=100%)					
OUTPUT VOLTAGE ADJUSTMENT RANGE[V]	2.85 - 3.6	Fixed ("Y"which can be adjusted the output is available as option :5, 12, 15, 24V ±10%)					
OUTPUT VOLTAGE SETTING[V]	—	4.9 - 5.3	11.5 - 12.5	14.4 - 15.6	23.0 - 25.0		
PROTECTION CIRCUIT AND OTHERS	OVERCURRENT PROTECTION	Works over 105% of rating and recovers automatically					
	OVERVOLTAGE PROTECTION	4.00 - 5.25V	Works at 115 - 140% of rating				
	OPERATING INDICATION	Not provided					
	REMOTE SENSING	Not provided					
ISOLATION	REMOTE ON/OFF	Not provided					
	INPUT-OUTPUT	AC3.000V 1minute, Cutoff current = 10mA, DC500V 50MΩ min (At Room Temperature)					
	INPUT-FG	AC2.000V 1minute, Cutoff current = 10mA, DC500V 50MΩ min (At Room Temperature)					
ENVIRONMENT	OUTPUT-FG	AC500V 1minute, Cutoff current = 100mA, DC500V 50MΩ min (At Room Temperature)					
	OPERATING TEMP.,HUMID.AND ALTIITUDE	-10 to +60°C, 20 - 90%RH (Non condensing) (Refer to DERATING CURVE) 3.000m (10.000feet) max					
	STORAGE TEMP.,HUMID.AND ALTIITUDE	-20 to +75°C, 20 - 90%RH (Non condensing) 9.000m (30.000feet) max					
	VIBRATION	10 - 55Hz, 19.6m/s <sup>2</sup> (2G), 3minutes period, 60minutes each along X, Y and Z axis					
SAFETY AND NOISE REGULATIONS	IMPACT	196.1m/s <sup>2</sup> (20G), 11ms, once each X, Y and Z axis					
	AGENCY APPROVALS	UL60950-1, EN60950-1, EN50178, CSA C22.2 No.60950-1 Complies with DEN-AN and IEC60950-1					
	CONDUCTED NOISE	Complies with FCC-B, CISPR22-B, EN55022-B, VCCI-B					
OTHERS	CASE SIZE/WEIGHT	55 X 26 X 133mm (W X H X D) /200g max (without chassis and cover)					
	COOLING METHOD	Convection					

\*1 Drift is the change in DC output for an eight hour period after a half-hour warm-up at 25°C, with the input voltage held constant at the rated input/output.  
 \*2 Please contact us about safety approvals for the model with option.  
 \* Avoid prolonged use under over-load.  
 \* Series/Parallel operation with other model is not possible.  
 \* Derating is required when operated with chassis and cover.

## External view

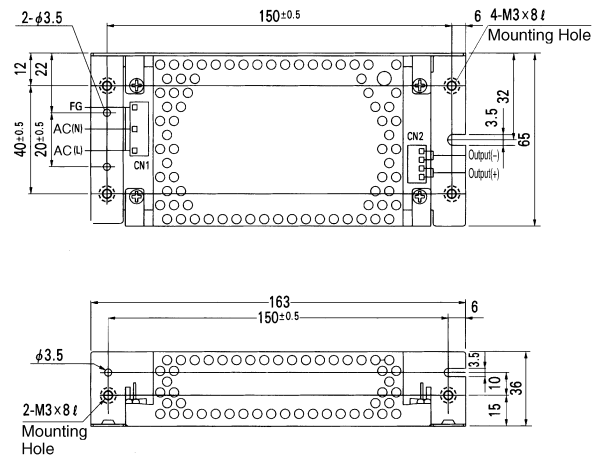
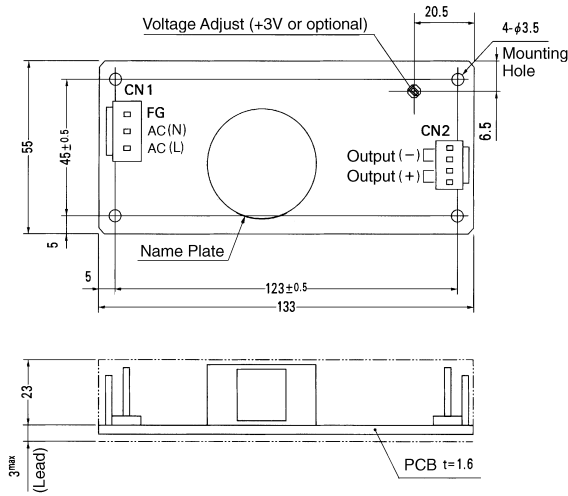

I/O Connector	Mating Connector	Terminal
CN1	B3P5-VH	VHR-5N
		Chain:SVH-21T-P1.1 Loose:BVH-21T-P1.1
CN2	B4P-VH	VHR-4N
		Chain:SVH-21T-P1.1 Loose:BVH-21T-P1.1

(Mfr : J.S.T.)

### <PIN CONNECTION>

Pin No.	Input
1	AC(L)
2	AC(N)
3	AC(N)
4	AC(N)
5	FG

Pin No.	Output
1	-V
2	-V
3	+V
4	+V

- ※ Weight : 200g or less (Without chassis and cover)
- ※ Tolerance : ± 1
- ※ Dimensions in mm.
- ※ PCB Material : Glass composite (CEM3)
- ※ Chassis and cover is optional.
- ※ Mounting torque : 0.6N·m (6.3kgf·cm) max

※ Keep drawing current per pin below 5A for CN2.

LDA

## Performance data

### ■ STATIC CHARACTERISTICS (LDA30F-5)

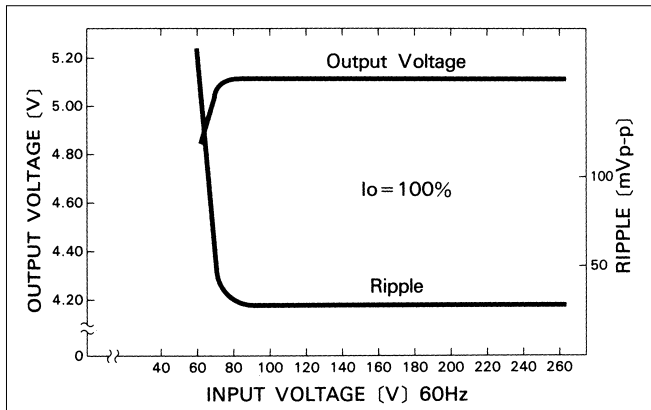

### ■ RISE TIME & FALL TIME (LDA30F-5)

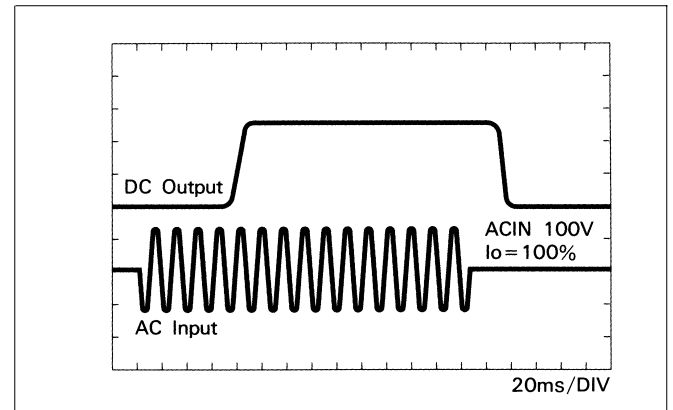

### ■ OVERCURRENT CHARACTERISTICS (LDA30F-5)

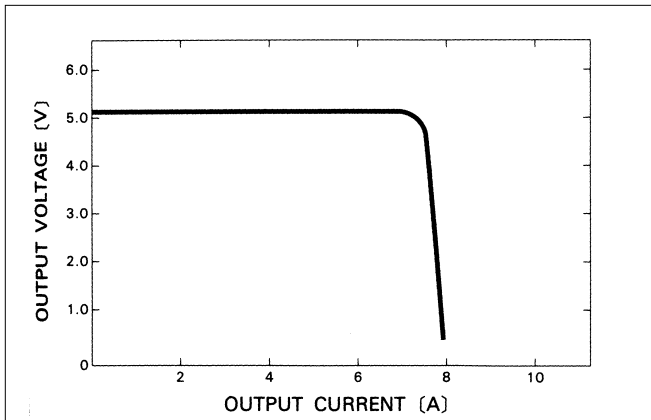

### ■ DERATING CURVE

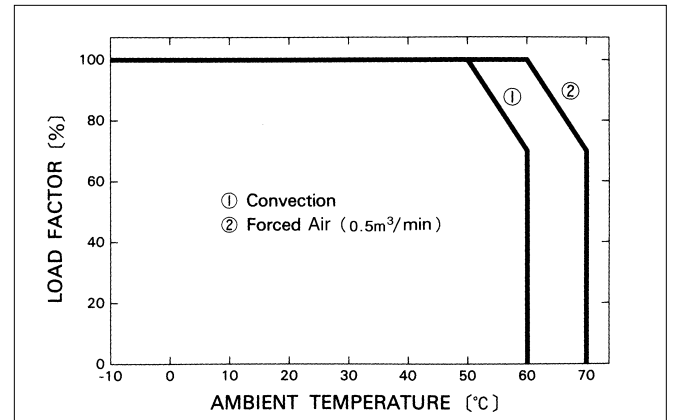

# LDA50F

LDA 50 F -5 -□

① ② ③ ④ ⑤



Recommended EMI/EMC Filter  
NAC-06-472



High voltage pulse noise type : NAP series  
Low leakage current type : NAM series  
\*The EMI/EMC Filter is recommended to connect with several devices.

- ① Series name
- ② Output wattage
- ③ Universal input
- ④ Output voltage
- ⑤ Optional \*4
- C :with Coating
- G :Low leakage current
- R :with Remote ON/OFF
- S :with Chassis
- SN :with Chassis & cover
- Y :with Potentiometer

MODEL	LDA50F-3	LDA50F-5	LDA50F-9	LDA50F-12	LDA50F-15	LDA50F-18	LDA50F-24	LDA50F-24-H	LDA50F-24-HR	LDA50F-30
MAX OUTPUT WATTAGE[W]	30	50	50.4	51.6	52.5	50.4	50.4	50.4	50.4	51
DC OUTPUT	*3 3V 10A	5V 10A	9V 5.6A	12V 4.3A	15V 3.5A	18V 2.8A	24V 2.1A	24V 2.1(3)A	24V 2.1(3)A	30V 1.7A

## SPECIFICATIONS

	MODEL	LDA50F-3	LDA50F-5	LDA50F-9	LDA50F-12	LDA50F-15	LDA50F-18	LDA50F-24	LDA50F-24-H	LDA50F-24-HR	LDA50F-30	
INPUT	VOLTAGE[V]	AC85 - 264 1 φ or DC110 - 370										
	CURRENT[A]	ACIN 100V	1.3typ (Io=100%)									
		ACIN 200V	0.7typ (Io=100%)									
	FREQUENCY[Hz]	47 - 440 or DC										
	EFFICIENCY[%]	73typ	77typ	78typ	80typ	81typ	81typ	82typ	82typ	82typ	82typ	
	INRUSH CURRENT[A]	ACIN 100V	15typ (Io=100%) (At cold start)									
		ACIN 200V	30typ (Io=100%) (At cold start)									
LEAKAGE CURRENT[mA]	0.75max (60Hz, According to UL, CSA, VDE and DEN-AN)											
OUTPUT	VOLTAGE[V]	3	5	9	12	15	18	24	24	24	30	
	CURRENT[A]	*1 10	10	5.6	4.3	3.5	2.8	2.1	2.1 (3)	2.1 (3)	1.7	
	LINE REGULATION[mV]	20max	20max	36max	48max	60max	72max	96max	96max	96max	120max	
	LOAD REGULATION[mV]	40max	40max	100max	100max	120max	120max	150max	150max	150max	180max	
	RIPPLE[mVp-p]	0 to +50°C	80max	80max	120max	120max	120max	120max	120max	120max	120max	
		-10 - 0°C	140max	140max	160max	160max	160max	160max	160max	160max	160max	
	RIPPLE NOISE[mVp-p]	0 to +50°C	120max	120max	150max	150max	150max	150max	150max	250max	250max	
		-10 - 0°C	160max	160max	180max	180max	180max	180max	180max	280max	280max	
	TEMPERATURE REGULATION[mV]	60max	60max	120max	150max	180max	200max	290max	290max	290max	360max	
	DRIFT[mV]	*2 20max	20max	36max	48max	60max	72max	96max	96max	96max	120max	
	START-UP TIME[ms]	200max (ACIN 100V, Io=100%)										
	HOLD-UP TIME[ms]	10typ (ACIN 85V, Io=100%) 20typ (ACIN 100V, Io=100%)										
	OUTPUT VOLTAGE ADJUSTMENT RANGE[V]	2.85 - 3.6	Fixed ("Y"which can be adjusted the output is available as option :5, 9, 12, 15, 18, 24, 30V ±10%)									
OUTPUT VOLTAGE SETTING[V]	—	4.9 - 5.3	8.6 - 9.4	11.5 - 12.5	14.4 - 15.6	17.3 - 18.7	23.0 - 25.0	23.0 - 25.0	23.0 - 25.0	28.5 - 31.5		
PROTECTION CIRCUIT AND OTHERS	OVERCURRENT PROTECTION	Works over 105% of rating (-H : peak) and recovers automatically										
	OVERVOLTAGE PROTECTION	4.00 - 5.25V Works at 115 - 140% of rating										
	OPERATING INDICATION	Not provided										
	REMOTE SENSING	Not provided										
ISOLATION	REMOTE ON/OFF	Option (Refer to Instruction Manual)										
	INPUT-OUTPUT	AC3.000V 1minute, Cutoff current = 10mA, DC500V 50MΩ min (At Room Temperature)										
ENVIRONMENT	INPUT-FG	AC2.000V 1minute, Cutoff current = 10mA, DC500V 50MΩ min (At Room Temperature)										
	OUTPUT-FG	AC500V 1minute, Cutoff current = 100mA, DC500V 50MΩ min (At Room Temperature)										
SAFETY AND NOISE REGULATIONS	OPERATING TEMP.,HUMID.AND ALTIITUDE	-10 to +60°C, 20 - 90%RH (Non condensing) (Refer to DERATING CURVE) 3.000m (10.000feet) max										
	STORAGE TEMP.,HUMID.AND ALTIITUDE	-20 to +75°C, 20 - 90%RH (Non condensing) 9.000m (30.000feet) max										
	VIBRATION	10 - 55Hz, 19.6m/s <sup>2</sup> (2G), 3minutes period, 60minutes each along X, Y and Z axis										
OTHERS	IMPACT	196.1m/s <sup>2</sup> (20G), 11ms, once each X, Y and Z axis										
	AGENCY APPROVALS	UL60950-1, EN60950-1, EN50178, CSA C22.2 No.60950-1 Complies with DEN-AN and IEC60950-1										
OTHERS	CONDUCTED NOISE	Complies with FCC-B, CISPR22-B, EN55022-B, VCCI-B										
	CASE SIZE/WEIGHT	55 X 26 X 195mm (W X H X D) /250g max (without chassis and cover)										
	COOLING METHOD	Convection										

\*1 Peak load for 10sec. or less is acceptable if the total wattage is less than the rated wattage(24V:50.4W).  
 \*2 Drift is the change in DC output for an eight hour period after a half-hour warm-up at 25°C,with the input voltage held constant at the rated input/output.  
 \*3 ( ) : peak current  
 \*4 Please contact us about safety approvals for the model with option.

\* Avoid prolonged use under over-load.  
 \* Parallel operation with other model is not possible.  
 \* Derating is required when operated with chassis and cover.

## External view



I/O Connector	Mating Connector	Terminal
CN1	B3P5-VH	VHR-5N
CN2	B4P-VH	VHR-4N
CN3	B2B-XH-A	XHP-2

### <PIN CONNECTION>

Pin No.	Input
1	AC(L)
2	
3	AC(N)
4	
5	FG

Pin No.	Output
1	-V
2	-V
3	+V
4	+V

Pin No.	Remote ON/OFF
1	RC(+)
2	RC(-)

※ Keep drawing current per pin below 5A for CN2.

- ※ Weight : 250g or less (Without chassis and cover)
- ※ Tolerance : ±1
- ※ Dimensions in mm.
- ※ PCB Material : Glass composite (CEM3)
- ※ Chassis and cover is optional.
- ※ Mounting torque : 0.6N·m (6.3kgf·cm) max

## Performance data

### ■ STATIC CHARACTERISTICS (LDA50F-5)



### ■ RISE TIME & FALL TIME (LDA50F-5)



### ■ OVERCURRENT CHARACTERISTICS (LDA50F-5)



### ■ DERATING CURVE

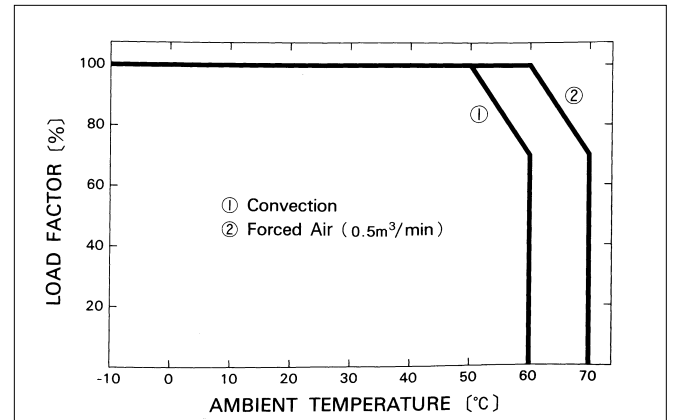



# LDA75F

LDA 75 F -5 -□

① ② ③ ④ ⑤



Recommended EMI/EMC Filter  
NAC-06-472



High voltage pulse noise type : NAP series  
Low leakage current type : NAM series  
\*The EMI/EMC Filter is recommended to connect with several devices.

- ① Series name
- ② Output wattage
- ③ Universal input
- ④ Output voltage
- ⑤ Optional \*4
- C :with Coating
- G :Low leakage current
- L :with LED
- R :with Remote ON/OFF
- S :with Chassis
- SN :with Chassis & cover
- Y :with Potentiometer

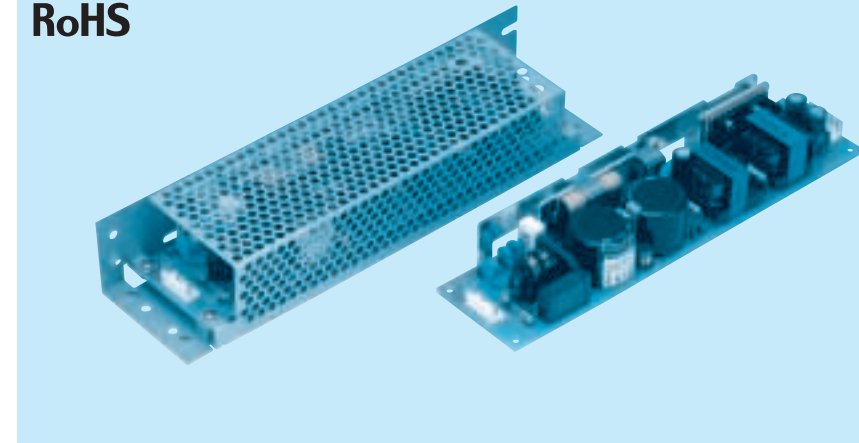

MODEL	LDA75F-3	LDA75F-5	LDA75F-9	LDA75F-12	LDA75F-15	LDA75F-18	LDA75F-24	LDA75F-24-H	LDA75F-24-HR	LDA75F-30
MAX OUTPUT WATTAGE[W]	45	75	76.5	75.6	75	75.6	76.8	76.8	76.8	75
DC OUTPUT	*3 3V 15A	5V 15A	9V 8.5A	12V 6.3A	15V 5A	18V 4.2A	24V 3.2A	24V 3.2(4.5)A	24V 3.2(4.5)A	30V 2.5A

## SPECIFICATIONS

MODEL	LDA75F-3	LDA75F-5	LDA75F-9	LDA75F-12	LDA75F-15	LDA75F-18	LDA75F-24	LDA75F-24-H	LDA75F-24-HR	LDA75F-30														
INPUT	VOLTAGE[V]											AC85 - 264 1 φ or DC110 - 370												
	CURRENT[A]		ACIN 100V											1.8typ (Io=100%)										
			ACIN 200V											1.0typ (Io=100%)										
	FREQUENCY[Hz]											47 - 440												
	EFFICIENCY[%]											73typ 79typ 79typ 80typ 81typ 81typ 82typ 82typ 82typ 82typ												
	INRUSH CURRENT[A]		ACIN 200V											30typ (Io=100%) (At cold start)										
LEAKAGE CURRENT[mA]											0.75max (60Hz, According to UL, CSA, VDE and DEN-AN)													
OUTPUT	VOLTAGE[V]		3		5		9		12		15		18		24		24		24		30			
	CURRENT[A]		*1 15		15		8.5		6.3		5		4.2		3.2		3.2 (4.5)		3.2 (4.5)		2.5			
	LINE REGULATION[mV]		20max		20max		36max		48max		60max		72max		96max		96max		96max		120max			
	LOAD REGULATION[mV]		40max		40max		100max		100max		120max		120max		150max		150max		150max		180max			
	RIPPLE[mVp-p]		0 to +50°C		80max		80max		120max		120max		120max		120max		120max		120max		120max			
			-10 - 0°C		140max		140max		160max		160max		160max		160max		160max		160max		160max			
	RIPPLE NOISE[mVp-p]		0 to +50°C		120max		120max		150max		150max		150max		150max		150max		250max		250max		150max	
			-10 - 0°C		160max		160max		180max		180max		180max		180max		180max		280max		280max		180max	
	TEMPERATURE REGULATION[mV]		60max		60max		120max		150max		180max		200max		290max		290max		290max		360max			
	DRIFT[mV]		*2 20max		20max		36max		48max		60max		72max		96max		96max		96max		120max			
START-UP TIME[ms]		200max (ACIN 100V, Io=100%)																						
HOLD-UP TIME[ms]		10typ (ACIN 85V, Io=100%) 20typ (ACIN 100V, Io=100%)																						
OUTPUT VOLTAGE ADJUSTMENT RANGE[V]		2.85 - 3.6 Fixed ("Y"which can be adjusted the output is available as option : 5, 9, 12, 15, 18, 24, 30V ±10%)																						
OUTPUT VOLTAGE SETTING[V]		—		4.9 - 5.3		8.6 - 9.4		11.5 - 12.5		14.4 - 15.6		17.3 - 18.7		23.0 - 25.0		23.0 - 25.0		23.0 - 25.0		28.5 - 31.5				
PROTECTION CIRCUIT AND OTHERS	OVERCURRENT PROTECTION		Works over 105% of rating (-H : peak) and recovers automatically																					
	OVERVOLTAGE PROTECTION		4.00 - 5.25V Works at 115 - 140% of rating																					
	OPERATING INDICATION		Not provided																					
	REMOTE SENSING		Not provided																					
REMOTE ON/OFF		Option (Refer to Instruction Manual)																						
ISOLATION	INPUT-OUTPUT		AC3,000V 1minute, Cutoff current = 10mA, DC500V 50MΩ min (At Room Temperature)																					
	INPUT-FG		AC2,000V 1minute, Cutoff current = 10mA, DC500V 50MΩ min (At Room Temperature)																					
OUTPUT-FG		AC500V 1minute, Cutoff current = 100mA, DC500V 50MΩ min (At Room Temperature)																						
ENVIRONMENT	OPERATING TEMP.,HUMID.AND ALTIITUDE		-10 to +60°C, 20 - 90%RH (Non condensing) (Refer to DERATING CURVE) 3,000m (10,000feet) max																					
	STORAGE TEMP.,HUMID.AND ALTIITUDE		-20 to +75°C, 20 - 90%RH (Non condensing) 9,000m (30,000feet) max																					
	VIBRATION		10 - 55Hz, 19.6m/s <sup>2</sup> (2G), 3minutes period, 60minutes each along X, Y and Z axis																					
IMPACT		196.1m/s <sup>2</sup> (20G), 11ms, once each X, Y and Z axis																						
SAFETY AND NOISE REGULATIONS	AGENCY APPROVALS		UL60950-1, EN60950-1, EN50178, CSA C22.2 No.60950-1 Complies with DEN-AN and IEC60950-1																					
	CONDUCTED NOISE		Complies with FCC-B, CISPR22-B, EN55022-B, VCCI-B																					
OTHERS	CASE SIZE/WEIGHT		55 X 32 X 222mm (W X H X D) /320g max (without chassis and cover)																					
	COOLING METHOD		Convection																					

\*1 Peak load for 10sec. or less is acceptable if the total wattage is less than the rated wattage(24V:76.8W).  
 \*2 Drift is the change in DC output for an eight hour period after a half-hour warm-up at 25°C,with the input voltage held constant at the rated input/output.  
 \*3 ( ) : peak current  
 \*4 Please contact us about safety approvals for the model with option.

\* Avoid prolonged use under over-load.  
 \* Parallel operation with other model is not possible.  
 \* Derating is required when operated with chassis and cover.

External view



I/O Connector	Mating Connector	Terminal
CN1	B3P5-VH	VHR-5N
CN2	B6P-VH	VHR-6N
CN3	B2B-XH-A	XHP-2

<PIN CONNECTION>

Pin No.	Input
1	AC(L)
2	AC(N)
3	AC(N)
4	FG
5	FG

Pin No.	Output
1~3	-V
4~6	+V

Pin No.	Remote ON/OFF
1	RC(+)
2	RC(-)

※Keep drawing current per pin below 5A for CN2.

- ※ Weight : 320g or less (Without chassis and cover)
- ※ Tolerance : ± 1
- ※ Dimensions in mm.
- ※ PCB Material : Glass composite (CEM3)
- ※ Chassis and cover is optional.
- ※ Mounting torque : 1.5 N·m (16 kgf·cm) max

Performance data

■ STATIC CHARACTERISTICS (LDA75F-5)

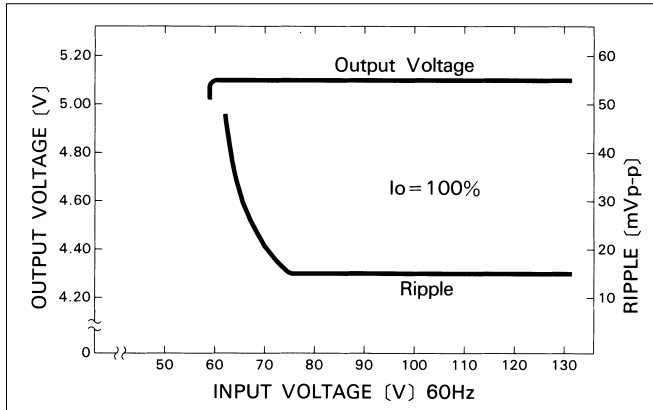

■ RISE TIME & FALL TIME (LDA75F-5)



■ OVERCURRENT CHARACTERISTICS (LDA75F-5)

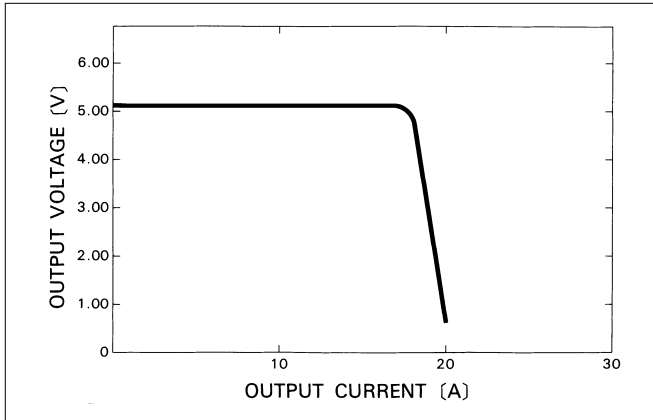

■ DERATING CURVE

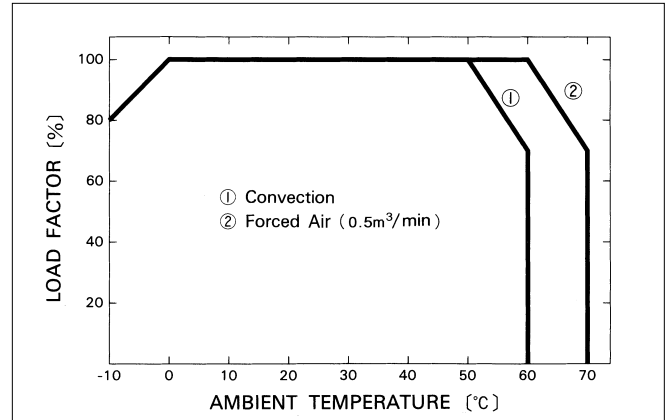

# LDA100W

LDA 100 W -5 -□

① ② ③ ④ ⑤



Recommended EMI/EMC Filter  
NAC-06-472



High voltage pulse noise type : NAP series  
Low leakage current type : NAM series  
\*The EMI/EMC Filter is recommended to connect with several devices.

- ① Series name
- ② Output wattage
- ③ Autoranging input
- ④ Output voltage
- ⑤ Optional \*4
- C :with Coating
- G :Low leakage current
- R :with Remote ON/OFF
- S :with Chassis
- SN :with Chassis & cover
- Y :with Potentiometer

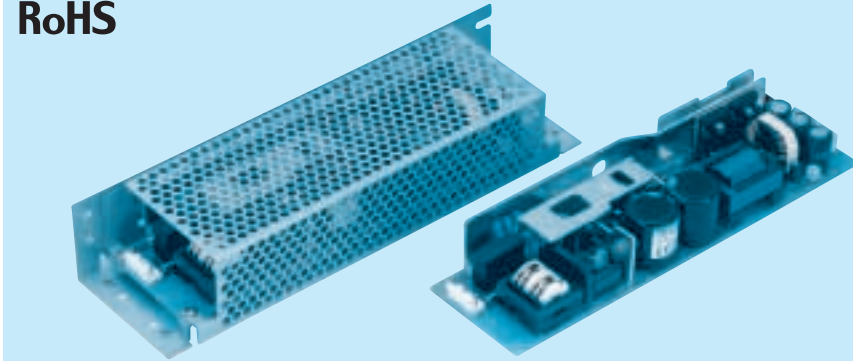

MODEL	LDA100W-3	LDA100W-5	LDA100W-9	LDA100W-12	LDA100W-15	LDA100W-18	LDA100W-24	LDA100W-24-H	LDA100W-30	LDA100W-48
MAX OUTPUT WATTAGE[W]	60	100	103.5	102	100.5	100.8	103.2	103.2	105	96
DC OUTPUT	*3 3V 20A	5V 20A	9V 11.5A	12V 8.5A	15V 6.7A	18V 5.6A	24V 4.3A	24V 4.3(6.5)A	30V 3.5A	48V 2.0A

## SPECIFICATIONS

MODEL	LDA100W-3	LDA100W-5	LDA100W-9	LDA100W-12	LDA100W-15	LDA100W-18	LDA100W-24	LDA100W-24-H	LDA100W-30	LDA100W-48	
INPUT	MODEL										
	VOLTAGE[V]										
	ACIN 100V										
	ACIN 200V										
	FREQUENCY[Hz]										
	EFFICIENCY[%]										
INPUT	INRUSH CURRENT[A]										
	LEAKAGE CURRENT[mA]										
	VOLTAGE[V]										
	CURRENT[A]										
	LINE REGULATION[mV]										
	LOAD REGULATION[mV]										
OUTPUT	RIPPLE[mVp-p]										
	RIPPLE NOISE[mVp-p]										
	TEMPERATURE REGULATION[mV]										
	DRIFT[mV]										
	START-UP TIME[ms]										
	HOLD-UP TIME[ms]										
PROTECTION CIRCUIT AND OTHERS	OVERCURRENT PROTECTION										
	OVERVOLTAGE PROTECTION										
	OPERATING INDICATION										
	REMOTE SENSING										
	REMOTE ON/OFF										
	ISOLATION	INPUT-OUTPUT									
INPUT-FG											
OUTPUT-FG											
ENVIRONMENT	OPERATING TEMP.,HUMID.AND ALTIITUDE										
	STORAGE TEMP.,HUMID.AND ALTIITUDE										
	VIBRATION										
	IMPACT										
SAFETY AND NOISE REGULATIONS	AGENCY APPROVALS										
	CONDUCTED NOISE										
OTHERS	CASE SIZE/WEIGHT										
	COOLING METHOD										

\*1 Peak load for 20sec. or less is acceptable if the total wattage is less than the rated wattage(24V:103.2W).  
\*2 Drift is the change in DC output for an eight hour period after a half-hour warm-up at 25°C, with the input voltage held constant at the rated input/output.  
\*3 ( ) : peak current  
\*4 Please contact us about safety approvals for the model with option.

\* Avoid prolonged use under over-load.  
\* Parallel operation with other model is not possible.  
\* Derating is required when operated with chassis and cover.

## External view

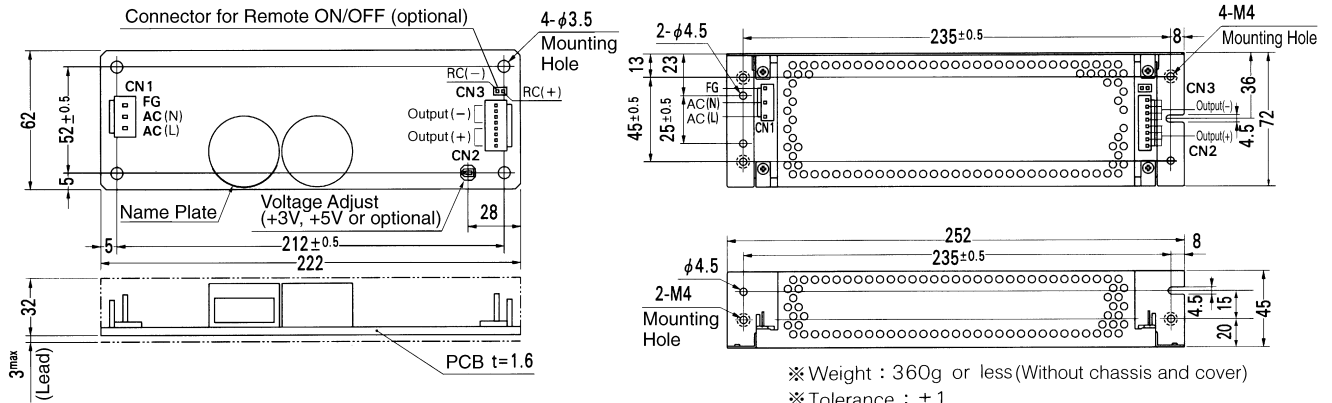

- ※ Weight : 360g or less (Without chassis and cover)
- ※ Tolerance : ± 1
- ※ Dimensions in mm.
- ※ PCB Material : Glass composite (CEM3)
- ※ Chassis and cover is optional.
- ※ Mounting torque : 1.5 N·m (16 kgf·cm) max

I/O Connector	Mating Connector	Terminal	
CN1	B3P5-VH	VHR-5N	Chain: SVH-21T-P1.1
			Loose: BVH-21T-P1.1
CN2	B8P-VH	VHR-8N	Chain: SVH-21T-P1.1
			Loose: BVH-21T-P1.1
CN3	B2B-XH-A	XHP-2	Chain: SXH-001T-P0.6
			Loose: BXH-001T-P0.6

(Mfr : J.S.T.)

### <PIN CONNECTION>

CN1	Pin No.	Input	CN2	Pin No.	Output	CN3	Pin No.	Remote ON/OFF
	1	AC(L)		1~4	-V		1	RC(+)
2						2	RC(-)	
3	AC(N)							
4								
5	FG							

※ Keep drawing current per pin below 5A for CN2.

## Performance data

### ■ STATIC CHARACTERISTICS (LDA100W-5)

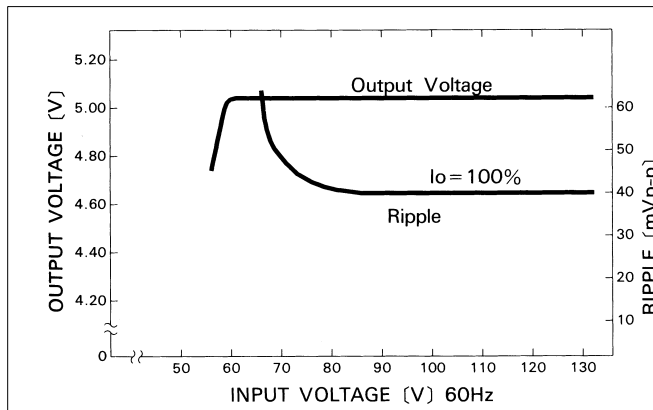

### ■ RISE TIME & FALL TIME (LDA100W-5)

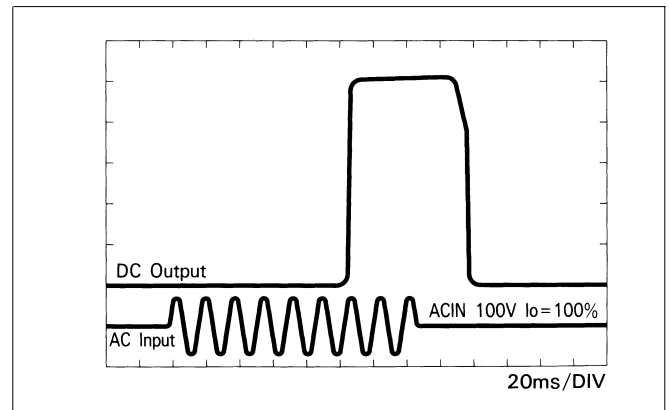

### ■ OVERCURRENT CHARACTERISTICS (LDA100W-5)



### ■ DERATING CURVE



# LDA150W

LDA 150 W -5 -□

① ② ③ ④ ⑤



RoHS

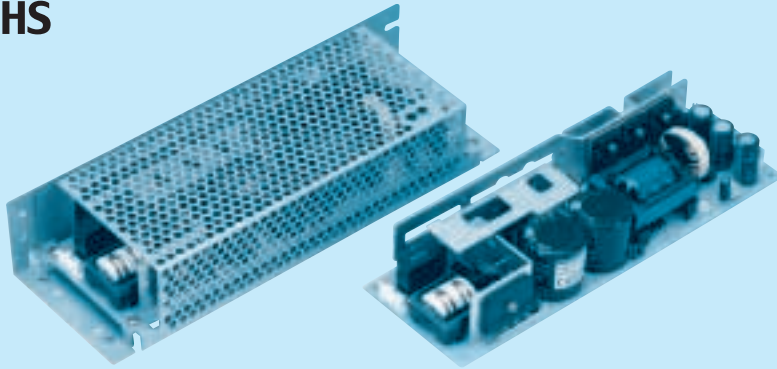

Recommended EMI/EMC Filter  
NAC-06-472



High voltage pulse noise type : NAP series  
Low leakage current type : NAM series  
\*The EMI/EMC Filter is recommended to connect with several devices.

- ① Series name
- ② Output wattage
- ③ Autoranging input
- ④ Output voltage
- ⑤ Optional \*4
- C :with Coating
- G :Low leakage current
- L :with LED
- R :with Remote ON/OFF
- S :with Chassis
- SN :with Chassis & cover
- Y :with Potentiometer

MODEL	LDA150W-3	LDA150W-5	LDA150W-9	LDA150W-12	LDA150W-15	LDA150W-18	LDA150W-24	LDA150W-24-H	LDA150W-30	LDA150W-48
MAX OUTPUT WATTAGE[W]	90	150	153	150	150	153	151.2	151.2	150	144
DC OUTPUT	*3 3V 30A	5V 30A	9V 17A	12V 12.5A	15V 10A	18V 8.5A	24V 6.3A	24V 6.3(10)A	30V 5A	48V 3A

## SPECIFICATIONS

MODEL	LDA150W-3	LDA150W-5	LDA150W-9	LDA150W-12	LDA150W-15	LDA150W-18	LDA150W-24	LDA150W-24-H	LDA150W-30	LDA150W-48																					
INPUT	VOLTAGE[V]											AC 85 - 132 / 170 - 264 1 φ																			
	CURRENT[A]		ACIN 100V											3.6typ (Io=100%)																	
			ACIN 200V											2.0typ (Io=100%)																	
	FREQUENCY[Hz]											47 - 440																			
	EFFICIENCY[%]											75typ		79typ		79typ		82typ		83typ		84typ		85typ		85typ		85typ		82typ	
	INRUSH CURRENT[A]		ACIN 200V											30typ (Io=100%) (At cold start)																	
LEAKAGE CURRENT[mA]											0.75max (60Hz, According to UL, CSA, VDE and DEN-AN)																				
OUTPUT	VOLTAGE[V]		3		5		9		12		15		18		24		24		30		48										
	CURRENT[A]		*1 30		30		17		12.5		10		8.5		6.3		6.3(10)		5		3										
	LINE REGULATION[mV]		20max		20max		36max		48max		60max		72max		96max		96max		120max		192max										
	LOAD REGULATION[mV]		40max		40max		100max		100max		120max		120max		150max		150max		180max		240max										
	RIPPLE[mVp-p]		0 to +50°C		80max		80max		120max		120max		120max		120max		220max		220max		150max										
			-10 - 0°C		140max		140max		160max		160max		160max		160max		160max		260max		160max		200max								
	RIPPLE NOISE[mVp-p]		0 to +50°C		120max		120max		150max		150max		150max		150max		150max		250max		150max		400max								
			-10 - 0°C		160max		160max		180max		180max		180max		180max		180max		280max		180max		600max								
	TEMPERATURE REGULATION[mV]		60max		60max		120max		150max		180max		200max		290max		290max		360max		560max										
	DRIFT[mV]		*2 20max		20max		36max		48max		60max		72max		96max		96max		120max		192max										
START-UP TIME[ms]		200max (ACIN 100V, Io=100%)																													
HOLD-UP TIME[ms]		10typ (ACIN 85V, Io=100%) 20typ (ACIN 100V, Io=100%)																													
OUTPUT VOLTAGE ADJUSTMENT RANGE[V]		2.85 - 3.6		4.5 - 5.5		Fixed ("Y" which can be adjusted the output is available as option :9, 12, 15, 18, 24, 30, 48V ±10%)																									
OUTPUT VOLTAGE SETTING[V]		—		—		8.6 - 9.4		11.5 - 12.5		14.4 - 15.6		17.3 - 18.7		23.0 - 25.0		23.0 - 25.0		28.5 - 31.5		46.0 - 50.0											
PROTECTION CIRCUIT AND OTHERS	OVERCURRENT PROTECTION		Works over 105% of rating (-H : peak) and recovers automatically																												
	OVERVOLTAGE PROTECTION		4.00 - 5.25V		Works at 115 - 140% of rating																										
	OPERATING INDICATION		Not provided																												
	REMOTE SENSING		Not provided																												
REMOTE ON/OFF		Option (Refer to Instruction Manual)																													
ISOLATION	INPUT-OUTPUT		AC3,000V 1minute, Cutoff current = 10mA, DC500V 50MΩ min (At Room Temperature)																												
	INPUT-FG		AC2,000V 1minute, Cutoff current = 10mA, DC500V 50MΩ min (At Room Temperature)																												
	OUTPUT-FG		AC500V 1minute, Cutoff current = 100mA, DC500V 50MΩ min (At Room Temperature)																												
ENVIRONMENT	OPERATING TEMP., HUMID. AND ALTITUDE		-10 to +60°C, 20 - 90%RH (Non condensing) (Refer to DERATING CURVE) 3,000m (10,000feet) max																												
	STORAGE TEMP., HUMID. AND ALTITUDE		-20 to +75°C, 20 - 90%RH (Non condensing) 9,000m (30,000feet) max																												
	VIBRATION		10 - 55Hz, 19.6m/s <sup>2</sup> (2G), 3minutes period, 60minutes each along X, Y and Z axis																												
	IMPACT		196.1m/s <sup>2</sup> (20G), 11ms, once each X, Y and Z axis																												
SAFETY AND NOISE REGULATIONS	AGENCY APPROVALS		UL60950-1, EN60950-1, EN50178, CSA C22.2 No.234 Complies with DEN-AN and IEC60950-1																												
	CONDUCTED NOISE		Complies with FCC-B, CISPR22-B, EN55022-B, VCCI-B																												
OTHERS	CASE SIZE/WEIGHT		75×37×222mm (W×H×D) /510g max (without chassis and cover)																												
	COOLING METHOD		Convection																												

\*1 Peak load for 10sec. or less is acceptable if the total wattage is less than the rated wattage(24V:151.2W).

\*2 Drift is the change in DC output for an eight hour period after a half-hour warm-up at 25°C, with the input voltage held constant at the rated input/output.

\*3 ( ) : peak current

\*4 Please contact us about safety approvals for the model with option.

\* Avoid prolonged use under over-load.

\* Parallel operation with other model is not possible.

\* Derating is required when operated with chassis and cover.

## External view



I/O Connector	Mating Connector	Terminal
CN1	B3P5-VH	VHR-5N
		Chain: SVH-21T-P1.1
		Loose: BVH-21T-P1.1
CN2	B6P-VH	VHR-6N
		Chain: SVH-21T-P1.1
		Loose: BVH-21T-P1.1
CN3	B7P-VH	VHR-7N
		Chain: SVH-21T-P1.1
		Loose: BVH-21T-P1.1
CN4	B2B-XH-A	XHP-2
		Chain: SXH-001T-P0.6
		Loose: BXH-001T-P0.6

### <PIN CONNECTION>

Pin No.	Input	Pin No.	Output	Pin No.	Remote ON/OFF
1	AC(L)	CN2 1~6	+V	1	RC(+)
2				2	RC(-)
3	AC(N)	CN3 1~7	-V		
4					
5	FG				

※ Keep drawing current per pin below 5A for CN2, CN3.

※ Weight : 510g or less  
(Without chassis and cover)

※ Tolerance : ±1

※ Dimensions in mm.

※ PCB Material : Glass composite (CEM3)

※ Chassis and cover is optional.

※ Chassis and cover is not available to remote ON/OFF unit.

※ Mounting torque : 1.5 N·m (16 kgf·cm) max

(Mfr : J.S.T.)

LDA

## Performance data

### ■ STATIC CHARACTERISTICS (LDA150W-5)

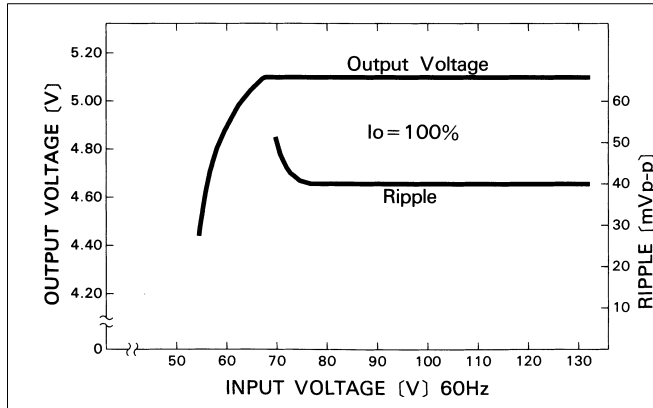

### ■ RISE TIME & FALL TIME (LDA150W-5)

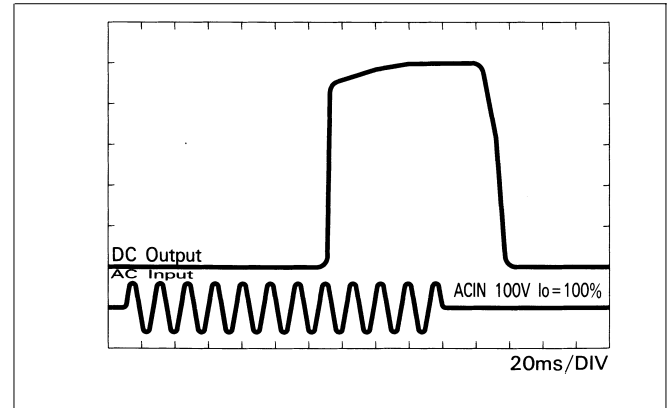

### ■ OVERCURRENT CHARACTERISTICS (LDA150W-5)



### ■ DERATING CURVE



# LDA300W

LDA 300 W -5 -□

① ② ③ ④ ⑤



Recommended EMI/EMC Filter  
NAC-16-472



High voltage pulse noise type : NAP series  
Low leakage current type : NAM series  
\*The EMI/EMC Filter is recommended to connect with several devices.

- ① Series name
- ② Output wattage
- ③ Autoranging input
- ④ Output voltage
- ⑤ Optional \*4
- C :with Coating
- G :Low leakage current
- L :with LED
- R :with Remote ON/OFF
- S :with Chassis
- SNF :with Chassis & cover & fan
- T :Vertical terminal block

MODEL	LDA300W-3	LDA300W-5	LDA300W-9	LDA300W-12	LDA300W-15	LDA300W-18	LDA300W-24	LDA300W-30	LDA300W-48
MAX OUTPUT WATTAGE[W]	180	300	306	324	330	306	336	300	302.4
DC OUTPUT	3V 60A	5V 60A	9V 34A	12V 27A	15V 22A	18V 17A	24V 14A	30V 10A	48V 6.3A

## SPECIFICATIONS

	MODEL	LDA300W-3	LDA300W-5	LDA300W-9	LDA300W-12	LDA300W-15	LDA300W-18	LDA300W-24	LDA300W-30	LDA300W-48	
INPUT	VOLTAGE[V]	AC 85 - 132 / 170 - 264 1 φ									
	CURRENT[A]	ACIN 100V	7.5typ (Io=100%)								
		ACIN 200V	4.5typ (Io=100%)								
	FREQUENCY[Hz]	47 - 440									
	EFFICIENCY[%]	ACIN 100V	72typ	78typ	78typ	80typ	81typ	81typ	83typ	83typ	83typ
		ACIN 200V	74typ	81typ	81typ	83typ	84typ	84typ	86typ	86typ	86typ
INRUSH CURRENT[A]	ACIN 100V	15/30A typ (Primary/Secondary Surge Current) Io=100% (More than 3sec.to re-start)									
	ACIN 200V	30/30typ (Primary/Secondary Surge Current) Io=100% (More than 3sec.to re-start)									
LEAKAGE CURRENT[mA]	0.75max (60Hz, According to UL, CSA, VDE and DEN-AN)										
OUTPUT	VOLTAGE[V]	3	5	9	12	15	18	24	30	48	
	CURRENT[A]	Forced air	60	60	34	27	22	17	14	10	6.3
		Convection*1	40 (60)	40 (60)	23 (34)	17 (27)	14 (22)	12 (17)	9 (14)	7 (10)	4.2 (6.3)
	LINE REGULATION[mV]	20max									
	LOAD REGULATION[mV]	40max									
	RIPPLE[mVp-p]	0 to +50°C*2	80max	80max	120max	120max	120max	120max	120max	120max	150max
		-10 - 0°C*2	140max	140max	160max	160max	160max	160max	160max	160max	200max
	RIPPLE NOISE[mVp-p]	0 to +50°C*2	120max	120max	150max	150max	150max	150max	150max	150max	400max
		-10 - 0°C*2	160max	160max	180max	180max	180max	180max	180max	180max	600max
	TEMPERATURE REGULATION[mV]	60max									
	DRIFT[mV]	*3 20max									
START-UP TIME[ms]	200max (ACIN 100V, Io=100%)										
HOLD-UP TIME[ms]	10typ (ACIN 85V, Io=100%) 20typ (ACIN 100V, Io=100%)										
OUTPUT VOLTAGE ADJUSTMENT RANGE[V]	2.85 - 3.6 5, 9, 12, 15, 18, 24, 30, 48V ±10%										
PROTECTION CIRCUIT AND OTHERS	OVERCURRENT PROTECTION	Works over 105% of rating and recovers automatically									
	OVERVOLTAGE PROTECTION	4.00 - 5.25V Works at 115 - 140% of rating									
	OPERATING INDICATION	Not provided									
	REMOTE SENSING	Provided									
ISOLATION	REMOTE ON/OFF	Option (Refer to Instruction Manual)									
	INPUT-OUTPUT	AC3.000V 1minute, Cutoff current = 10mA, DC500V 50MΩ min (At Room Temperature)									
ENVIRONMENT	INPUT-FG	AC2.000V 1minute, Cutoff current = 10mA, DC500V 50MΩ min (At Room Temperature)									
	OUTPUT-FG	AC500V 1minute, Cutoff current = 100mA, DC500V 50MΩ min (At Room Temperature)									
SAFETY AND NOISE REGULATIONS	OPERATING TEMP.,HUMID.AND ALTIITUDE	-10 to +70°C, 20 - 90%RH (Non condensing) (Refer to DERATING CURVE) 3,000m (10,000feet) max									
	STORAGE TEMP.,HUMID.AND ALTIITUDE	-20 to +75°C, 20 - 90%RH (Non condensing) 9,000m (30,000feet) max									
	VIBRATION	10 - 55Hz, 19.6m/s <sup>2</sup> (2G), 3minutes period, 60minutes each along X, Y and Z axis									
OTHERS	IMPACT	196.1m/s <sup>2</sup> (20G), 11ms, once each X, Y and Z axis									
	AGENCY APPROVALS	UL60950-1, C-UL, EN60950-1, EN50178 Complies with DEN-AN and IEC60950-1									
OTHERS	CONDUCTED NOISE	Complies with FCC-B, CISPR22-B, EN55022-B, VCCI-B									
	CASE SIZE/WEIGHT	108×50×255mm (W×H×D) /1kg max (without terminal block)									
OTHERS	COOLING METHOD	Convection / Forced air (Refer to DERATING CURVE)									

\*1 Peak load for 30sec. or less is acceptable if the total wattage is less than the rated wattage.  
 \*2 This is the value that measured on measuring board with capacitor of 22 μF within 150mm from output terminal.  
 \*3 Drift is the change in DC output for an eight hour period after a half-hour warm-up at 25°C, with the input voltage held constant at the rated input/output.  
 \*4 Please contact us about safety approvals for the model with option.  
 \* Parallel operation with other model is not possible.  
 \* Derating is required when operated with chassis and cover.

## External view



Standard Model

Horizontal type

Vertical type

Optional Model "-T"  
(Ex. LDA300W-5-T)

Optional Model "-SNF"  
(EX. LDA300W-5-SNF)

Applicable options

Terminal Block Horizontal type		Terminal Block Vertical type	
-S	Available	-ST	Available
-SN	Not Available	-SNT	Not Available
-SNF	Available 5V, 12V, 24V	-SNFT	Not Available

CN1 (Connector for Sensing)  
Type: B4B-XH-A

Pin No.	Function
1	-M
2	-S (Remote Sensing)
3	+S (Remote Sensing)
4	+M

Mating Housing & Pin  
Mfr: J. S. T.  
XHP-4(BXH-001T-P0.6 or SXH-001T-P0.6)

CN2 (Optional connector for Remote ON/OFF: optional)  
Type: B2B-XH-A

Pin No.	Function
1	RC (+)
2	RC (-)

Mating Housing & Pin  
Mfr: J. S. T.  
XHP-2(BXH-001T-P0.6 or SXH-001T-P0.6)

- ※ Weight : 1kg or less (without casecover)
- ※ Tolerance : ±1
- ※ Dimensions : mm.
- ※ PCB Material : Glass composite (CEM3)
- ※ Keep drawing current per pin below 20A for TB2
- ※ Mounting torque : 1.5N·m (16kgf·cm) max

LDA

## Performance data

### ■ STATIC CHARACTERISTICS (LDA300W-5)

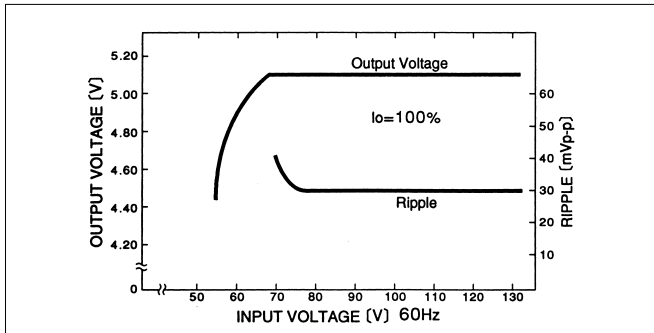

### ■ RISE TIME & FALL TIME (LDA300W-5)

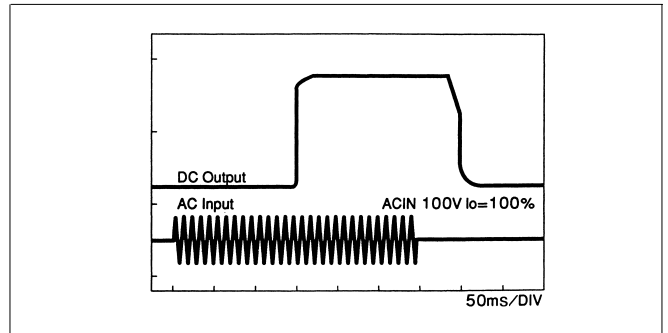

### ■ OVERCURRENT CHARACTERISTICS (LDA300W-5)

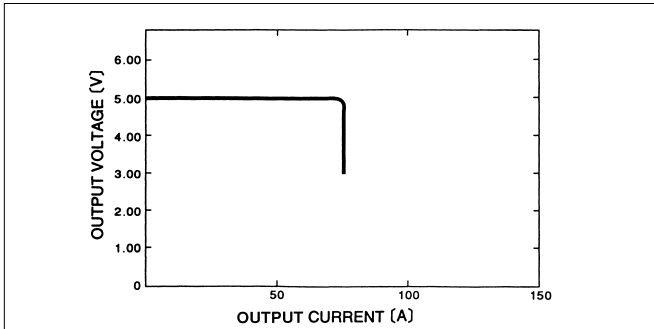

### ■ DERATING CURVE

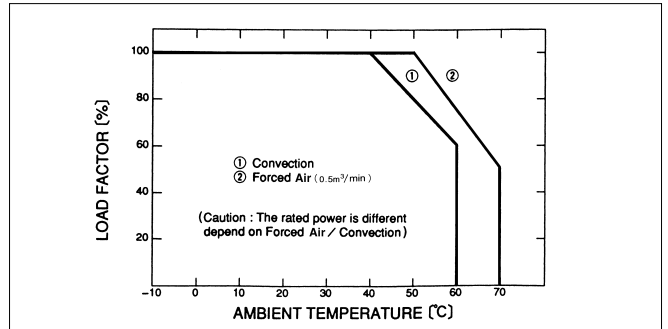



# Mouser Electronics

Authorized Distributor

Click to View Pricing, Inventory, Delivery & Lifecycle Information:

## Cosel:

[S-LDA300](#) [N-LDA75](#) [N-LDA150](#) [N-LDA10](#) [S-LDA15](#) [N-LDA30](#) [S-LDA150](#) [S-LDA50](#) [S-LDA10](#) [N-LDA100](#) [S-LDA100](#) [N-LDA50](#) [S-LDA75](#) [S-LDA30](#) [N-LDA15](#) [LDA50F-5-SNR](#) [LDA100W-24-H](#) [LDA100W-30-SNY](#) [LDA30F-24-SNG](#) [LDA75F-12-S](#) [LDA50F-12-Y](#) [LDA75F-24-SY](#) [LDA150W-9-RY](#) [LDA300W-5-RT](#) [LDA10F-12-SNY](#) [LDA150W-48-SN](#) [LDA100W-48](#) [LDA30F-12-SY](#) [LDA50F-24-GY](#) [LDA300W-3-CT](#) [LDA300W-24-R](#) [LDA150W-12-CR](#) [LDA75F-5-CY](#) [LDA10F-24-M](#) [LDA50F-24-S](#) [LDA30F-24](#) [LDA100W-15-RY](#) [LDA15F-5-GY](#) [LDA150W-18](#) [LDA15F-15-GY](#) [LDA10F-3-SNC](#) [LDA75F-12-M](#) [LDA150W-24-CR](#) [LDA50F-12-R](#) [LDA75F-24-R](#) [LDA75F-30-SNR](#) [LDA50F-3-M](#) [LDA30F-24-SN](#) [LDA15F-3-S](#) [LDA75F-5-V](#) [LDA75F-15-Y](#) [LDA300W-3-R](#) [LDA10F-15-SNQ](#) [LDA50F-24-SN](#) [LDA100W-9-Y](#) [LDA50F-15-SN](#) [LDA150W-30-TD28](#) [LDA300W-48-S](#) [LDA30F-15-SNY](#) [LDA50F-9-SNC](#) [LDA10F-5-S](#) [LDA75F-9-SN](#) [LDA150W-5-L](#) [LDA150W-30](#) [LDA300W-30-CT](#) [LDA150W-12-Y](#) [LDA100W-48-SNY](#) [LDA150W-3-C](#) [LDA30F-5-Y](#) [LDA75F-12-SNY](#) [LDA30F-12-G](#) [LDA75F-24-C](#) [LDA100W-12-SNRY](#) [LDA300W-24-C](#) [LDA100W-24-SNH](#) [LDA15F-5-Q](#) [LDA50F-30](#) [LDA75F-15](#) [LDA75F-9-Y](#) [LDA50F-5-G](#) [LDA30F-3-SNC](#) [LDA15F-24-CG](#) [LDA10F-5-SNC](#) [LDA30F-3-GD3.3](#) [LDA50F-24-CR](#) [LDA100W-48-CY](#) [LDA100W-5-CR](#) [LDA150W-24-SHY](#) [LDA10F-24-SNY](#) [LDA75F-3-SN](#) [LDA50F-30-SNRY](#) [LDA10F-5-SNY](#) [LDA300W-24-L](#) [LDA100W-5-SNC](#) [LDA300W-30-R](#) [LDA15F-12-S](#) [LDA100W-24-HY](#) [LDA50F-24-HY](#) [LDA50F-5-Y](#) [LDA15F-12-Y](#)



Компания «ЭлектроПласт» предлагает заключение долгосрочных отношений при поставках импортных электронных компонентов на взаимовыгодных условиях!

Наши преимущества:

- Оперативные поставки широкого спектра электронных компонентов отечественного и импортного производства напрямую от производителей и с крупнейших мировых складов;
- Поставка более 17-ти миллионов наименований электронных компонентов;
- Поставка сложных, дефицитных, либо снятых с производства позиций;
- Оперативные сроки поставки под заказ (от 5 рабочих дней);
- Экспресс доставка в любую точку России;
- Техническая поддержка проекта, помощь в подборе аналогов, поставка прототипов;
- Система менеджмента качества сертифицирована по Международному стандарту ISO 9001;
- Лицензия ФСБ на осуществление работ с использованием сведений, составляющих государственную тайну;
- Поставка специализированных компонентов (Xilinx, Altera, Analog Devices, Intersil, Interpoint, Microsemi, Aeroflex, Peregrine, Syfer, Eurofarad, Texas Instrument, Miteq, Cobham, E2V, MA-COM, Hittite, Mini-Circuits, General Dynamics и др.);

Помимо этого, одним из направлений компании «ЭлектроПласт» является направление «Источники питания». Мы предлагаем Вам помощь Конструкторского отдела:

- Подбор оптимального решения, техническое обоснование при выборе компонента;
- Подбор аналогов;
- Консультации по применению компонента;
- Поставка образцов и прототипов;
- Техническая поддержка проекта;
- Защита от снятия компонента с производства.



#### Как с нами связаться

**Телефон:** 8 (812) 309 58 32 (многоканальный)

**Факс:** 8 (812) 320-02-42

**Электронная почта:** [org@eplast1.ru](mailto:org@eplast1.ru)

**Адрес:** 198099, г. Санкт-Петербург, ул. Калинина, дом 2, корпус 4, литера А.