

LDA10F

LDA 10 F -5 -□

① ② ③ ④ ⑤



Recommended EMI/EMC Filter
NAC-06-472



High voltage pulse noise type : NAP series
Low leakage current type : NAM series
*The EMI/EMC Filter is recommended to connect with several devices.

- ① Series name
- ② Output wattage
- ③ Universal input
- ④ Output voltage
- ⑤ Optional *2
- C : with Coating
- G : Low leakage current
- S : with Chassis
- SN : with Chassis & cover
- Y : with Potentiometer

MODEL	LDA10F-3	LDA10F-5	LDA10F-12	LDA10F-15	LDA10F-24
MAX OUTPUT WATTAGE[W]	6	10	10.8	10.5	12
DC OUTPUT	3V 2.0A	5V 2.0A	12V 0.9A	15V 0.7A	24V 0.5A

SPECIFICATIONS

	MODEL	LDA10F-3	LDA10F-5	LDA10F-12	LDA10F-15	LDA10F-24	
INPUT	VOLTAGE[V]	AC85 - 264 1 φ or DC110 - 370					
	CURRENT[A]	ACIN 100V	0.25typ (Io=100%)				
		ACIN 200V	0.16typ (Io=100%)				
	FREQUENCY[Hz]	47 - 440 or DC					
	EFFICIENCY[%]	68typ	72typ	74typ	74typ	78typ	
	INRUSH CURRENT[A]	ACIN 100V	15typ (Io=100%) (At cold start)				
		ACIN 200V	30typ (Io=100%) (At cold start)				
LEAKAGE CURRENT[mA]	0.75max (60Hz, According to UL, CSA, VDE and DEN-AN)						
OUTPUT	VOLTAGE[V]	3	5	12	15	24	
	CURRENT[A]	2	2	0.9	0.7	0.5	
	LINE REGULATION[mV]	20max	20max	48max	60max	96max	
	LOAD REGULATION[mV]	40max	40max	100max	120max	150max	
	RIPPLE[mVp-p]	0 to +50°C	80max	80max	120max	120max	120max
		-10 - 0°C	140max	140max	160max	160max	160max
	RIPPLE NOISE[mVp-p]	0 to +50°C	120max	120max	150max	150max	150max
		-10 - 0°C	160max	160max	180max	180max	180max
	TEMPERATURE REGULATION[mV]	50max	50max	120max	150max	240max	
	DRIFT[mV]	*1 20max	20max	48max	60max	96max	
	START-UP TIME[ms]	200max (ACIN 100V, Io=100%)					
	HOLD-UP TIME[ms]	10typ (ACIN 85V, Io=100%) 20typ (ACIN 100V, Io=100%) 100typ (ACIN 200V, Io=100%)					
	OUTPUT VOLTAGE ADJUSTMENT RANGE[V]	2.85 - 3.6	Fixed ("Y" which can be adjusted the output is available as option :5, 12, 15, 24V ±10%)				
OUTPUT VOLTAGE SETTING[V]	—	4.9 - 5.3	11.5 - 12.5	14.4 - 15.6	23.0 - 25.0		
PROTECTION CIRCUIT AND OTHERS	OVERCURRENT PROTECTION	Works over 105% of rating and recovers automatically					
	OVERVOLTAGE PROTECTION	4.00V min	Works over 115% of rating, by zener diode clamping				
	OPERATING INDICATION	Not provided					
	REMOTE SENSING	Not provided					
ISOLATION	REMOTE ON/OFF	Not provided					
	INPUT-OUTPUT	AC3.000V 1minute, Cutoff current = 10mA, DC500V 50MΩ min (At Room Temperature)					
	INPUT-FG	AC2.000V 1minute, Cutoff current = 10mA, DC500V 50MΩ min (At Room Temperature)					
ENVIRONMENT	OUTPUT-FG	AC500V 1minute, Cutoff current = 100mA, DC500V 50MΩ min (At Room Temperature)					
	OPERATING TEMP., HUMID. AND ALTITUDE	-10 to +60°C, 20 - 90%RH (Non condensing) (Refer to DERATING CURVE) 3.000m (10.000feet) max					
	STORAGE TEMP., HUMID. AND ALTITUDE	-20 to +75°C, 20 - 90%RH (Non condensing) 9.000m (30.000feet) max					
	VIBRATION	10 - 55Hz, 19.6m/s ² (2G), 3minutes period, 60minutes each along X, Y and Z axis					
SAFETY AND NOISE REGULATIONS	IMPACT	196.1m/s ² (20G), 11ms, once each X, Y and Z axis					
	AGENCY APPROVALS	UL60950-1, EN60950-1, EN50178, CSA C22.2 No.60950-1 Complies with DEN-AN and IEC60950-1					
	CONDUCTED NOISE	Complies with FCC-B, CISPR22-B, EN55022-B, VCCI-B					
OTHERS	CASE SIZE/WEIGHT	50 X 21 X 105mm (W X H X D) /75g max (without chassis and cover)					
	COOLING METHOD	Convection					

*1 Drift is the change in DC output for an eight hour period after a half-hour warm-up at 25°C, with the input voltage held constant at the rated input/output.
 *2 Please contact us about safety approvals for the model with option.
 * Avoid prolonged use under over-load.
 * Series/Parallel operation with other model is not possible.
 * Derating is required when operated with chassis and cover.

External view



I/O Connector	Mating Connector	Terminal
CN1	B3P5-VH	VHR-5N
		Chain:SVH-21T-P1.1
		Loose:BVH-21T-P1.1
CN2	B4B-XH-A	XHP-4
		Chain:SXH-001T-P0.6
		Loose:BXH-001T-P0.6

(Mir : J.S.T.)

<PIN CONNECTION>

Pin No.	Input
1	AC(L)
2	
3	AC(N)
4	
5	FG

Pin No.	Output
1	-V
2	-V
3	+V
4	+V

※ Keep drawing current per pin below 2A for CN2.

- ※ Weight : 75g or less (Without chassis and cover)
- ※ Tolerance : ±1
- ※ Dimensions in mm.
- ※ PCB Material : Glass composite (CEM3)
- ※ Chassis and cover is optional.
- ※ Mounting torque : 0.6N·m (6.3kgf·cm) max

LDA

Performance data

■ STATIC CHARACTERISTICS (LDA10F-5)



■ RISE TIME & FALL TIME (LDA10F-5)



■ OVERCURRENT CHARACTERISTICS (LDA10F-5)



■ DERATING CURVE



LDA15F

LDA 15 F -5 -□

① ② ③ ④ ⑤



Recommended EMI/EMC Filter
NAC-06-472



High voltage pulse noise type : NAP series
Low leakage current type : NAM series
*The EMI/EMC Filter is recommended to connect with several devices.

- ① Series name
- ② Output wattage
- ③ Universal input
- ④ Output voltage
- ⑤ Optional *2
- C :with Coating
- G :Low leakage current
- S :with Chassis
- SN :with Chassis & cover
- Y :with Potentiometer

MODEL	LDA15F-3	LDA15F-5	LDA15F-12	LDA15F-15	LDA15F-24
MAX OUTPUT WATTAGE[W]	9	15	15.6	15	16.8
DC OUTPUT	3V 3.0A	5V 3.0A	12V 1.3A	15V 1.0A	24V 0.7A

SPECIFICATIONS

	MODEL	LDA15F-3	LDA15F-5	LDA15F-12	LDA15F-15	LDA15F-24	
INPUT	VOLTAGE[V]	AC85 - 264 1 φ or DC110 - 370					
	CURRENT[A]	ACIN 100V	0.37typ (Io=100%)				
		ACIN 200V	0.23typ (Io=100%)				
	FREQUENCY[Hz]	47 - 440 or DC					
	EFFICIENCY[%]	70typ	74typ	76typ	76typ	78typ	
	INRUSH CURRENT[A]	ACIN 100V	15typ (Io=100%) (At cold start)				
		ACIN 200V	30typ (Io=100%) (At cold start)				
LEAKAGE CURRENT[mA]	0.75max (60Hz, According to UL, CSA, VDE and DEN-AN)						
OUTPUT	VOLTAGE[V]	3	5	12	15	24	
	CURRENT[A]	3	3	1.3	1	0.7	
	LINE REGULATION[mV]	20max	20max	48max	60max	96max	
	LOAD REGULATION[mV]	40max	40max	100max	120max	150max	
	RIPPLE[mVp-p]	0 to +50°C	80max	80max	120max	120max	120max
		-10 - 0°C	140max	140max	160max	160max	160max
	RIPPLE NOISE[mVp-p]	0 to +50°C	120max	120max	150max	150max	150max
		-10 - 0°C	160max	160max	180max	180max	180max
	TEMPERATURE REGULATION[mV]	50max	50max	120max	150max	240max	
	DRIFT[mV]	*1 20max	20max	48max	60max	96max	
	START-UP TIME[ms]	200max (ACIN 100V, Io=100%)					
	HOLD-UP TIME[ms]	10typ (ACIN 85V, Io=100%) 20typ (ACIN 100V, Io=100%) 100typ (ACIN 200V, Io=100%)					
	OUTPUT VOLTAGE ADJUSTMENT RANGE[V]	2.85 - 3.6	Fixed ("Y"which can be adjusted the output is available as option :5, 12, 15, 24V ±10%)				
OUTPUT VOLTAGE SETTING[V]	—	4.9 - 5.3	11.5 - 12.5	14.4 - 15.6	23.0 - 25.0		
PROTECTION CIRCUIT AND OTHERS	OVERCURRENT PROTECTION	Works over 105% of rating and recovers automatically					
	OVERVOLTAGE PROTECTION	4.00V min	Works over 115% of rating, by zener diode clamping				
	OPERATING INDICATION	Not provided					
	REMOTE SENSING	Not provided					
ISOLATION	REMOTE ON/OFF	Not provided					
	INPUT-OUTPUT	AC3.000V 1minute, Cutoff current = 10mA, DC500V 50MΩ min (At Room Temperature)					
	INPUT-FG	AC2.000V 1minute, Cutoff current = 10mA, DC500V 50MΩ min (At Room Temperature)					
ENVIRONMENT	OUTPUT-FG	AC500V 1minute, Cutoff current = 100mA, DC500V 50MΩ min (At Room Temperature)					
	OPERATING TEMP.,HUMID.AND ALTIITUDE	-10 to +60°C, 20 - 90%RH (Non condensing) (Refer to DERATING CURVE) 3.000m (10.000feet) max					
	STORAGE TEMP.,HUMID.AND ALTIITUDE	-20 to +75°C, 20 - 90%RH (Non condensing) 9.000m (30.000feet) max					
	VIBRATION	10 - 55Hz, 19.6m/s ² (2G), 3minutes period, 60minutes each along X, Y and Z axis					
SAFETY AND NOISE REGULATIONS	IMPACT	196.1m/s ² (20G), 11ms, once each X, Y and Z axis					
	AGENCY APPROVALS	UL60950-1, EN60950-1, EN50178, CSA C22.2 No.60950-1 Complies with DEN-AN and IEC60950-1					
	CONDUCTED NOISE	Complies with FCC-B, CISPR22-B, EN55022-B, VCCI-B					
OTHERS	CASE SIZE/WEIGHT	50 X 21 X 125mm (W X H X D) /95g max (without chassis and cover)					
	COOLING METHOD	Convection					

*1 Drift is the change in DC output for an eight hour period after a half-hour warm-up at 25°C, with the input voltage held constant at the rated input/output.
 *2 Please contact us about safety approvals for the model with option.
 * Avoid prolonged use under over-load.
 * Series/Parallel operation with other model is not possible.
 * Derating is required when operated with chassis and cover.

External view



I/O Connector	Mating Connector	Terminal
CN1	B3P5-VH	VHR-5N
		Chain:SVH-21T-P1.1
		Loose:BVH-21T-P1.1
CN2	B4B-XH-A	XHP-4
		Chain: SXH-001T-P0.6
		Loose: BXH-001T-P0.6

(Mfr : J.S.T.)

<PIN CONNECTION>

Pin No.	Input
1	AC(L)
2	AC(N)
3	AC(N)
4	AC(N)
5	FG

Pin No.	Output
1	-V
2	-V
3	+V
4	+V

- ※ Weight : 95g or less (Without chassis and cover)
- ※ Tolerance : ± 1
- ※ Dimensions in mm.
- ※ PCB Material : Glass composite (CEM3)
- ※ Chassis and cover is optional.
- ※ Mounting torque : 0.6N·m (6.3kgf·cm) max

Performance data

■ STATIC CHARACTERISTICS (LDA15F-5)



■ RISE TIME & FALL TIME (LDA15F-5)



■ OVERCURRENT CHARACTERISTICS (LDA15F-5)



■ DERATING CURVE



LDA30F

LDA 30 F -5 -□

① ② ③ ④ ⑤



Recommended EMI/EMC Filter
NAC-06-472



High voltage pulse noise type : NAP series
Low leakage current type : NAM series
*The EMI/EMC Filter is recommended to connect with several devices.

- ① Series name
- ② Output wattage
- ③ Universal input
- ④ Output voltage
- ⑤ Optional *2
- C :with Coating
- G :Low leakage current
- S :with Chassis
- SN :with Chassis & cover
- Y :with Potentiometer



MODEL	LDA30F-3	LDA30F-5	LDA30F-12	LDA30F-15	LDA30F-24
MAX OUTPUT WATTAGE[W]	18	30	30	30	31.2
DC OUTPUT	3V 6.0A	5V 6.0A	12V 2.5A	15V 2.0A	24V 1.3A

SPECIFICATIONS

	MODEL	LDA30F-3	LDA30F-5	LDA30F-12	LDA30F-15	LDA30F-24	
INPUT	VOLTAGE[V]	AC85 - 264 1 φ or DC110 - 370					
	CURRENT[A]	ACIN 100V	0.8typ (Io=100%)				
		ACIN 200V	0.4typ (Io=100%)				
	FREQUENCY[Hz]	47 - 440 or DC					
	EFFICIENCY[%]	70typ	75typ	77typ	78typ	79typ	
	INRUSH CURRENT[A]	ACIN 100V	15typ (Io=100%) (At cold start)				
		ACIN 200V	30typ (Io=100%) (At cold start)				
LEAKAGE CURRENT[ma]	0.75max (60Hz, According to UL, CSA, VDE and DEN-AN)						
OUTPUT	VOLTAGE[V]	3	5	12	15	24	
	CURRENT[A]	6	6	2.5	2	1.3	
	LINE REGULATION[mV]	20max	20max	48max	60max	96max	
	LOAD REGULATION[mV]	40max	40max	100max	120max	150max	
	RIPPLE[mVp-p]	0 to +50°C	80max	80max	120max	120max	120max
		-10 - 0°C	140max	140max	160max	160max	160max
	RIPPLE NOISE[mVp-p]	0 to +50°C	120max	120max	150max	150max	150max
		-10 - 0°C	160max	160max	180max	180max	180max
	TEMPERATURE REGULATION[mV]	60max	60max	150max	180max	290max	
	DRIFT[mV]	*1 20max	20max	48max	60max	96max	
	START-UP TIME[ms]	200max (ACIN 100V, Io=100%)					
	HOLD-UP TIME[ms]	10typ (ACIN 85V, Io=100%) 20typ (ACIN 100V, Io=100%)					
OUTPUT VOLTAGE ADJUSTMENT RANGE[V]	2.85 - 3.6	Fixed ("Y"which can be adjusted the output is available as option :5, 12, 15, 24V ±10%)					
OUTPUT VOLTAGE SETTING[V]	—	4.9 - 5.3	11.5 - 12.5	14.4 - 15.6	23.0 - 25.0		
PROTECTION CIRCUIT AND OTHERS	OVERCURRENT PROTECTION	Works over 105% of rating and recovers automatically					
	OVERVOLTAGE PROTECTION	4.00 - 5.25V	Works at 115 - 140% of rating				
	OPERATING INDICATION	Not provided					
	REMOTE SENSING	Not provided					
ISOLATION	REMOTE ON/OFF	Not provided					
	INPUT-OUTPUT	AC3.000V 1minute, Cutoff current = 10mA, DC500V 50MΩ min (At Room Temperature)					
	INPUT-FG	AC2.000V 1minute, Cutoff current = 10mA, DC500V 50MΩ min (At Room Temperature)					
ENVIRONMENT	OUTPUT-FG	AC500V 1minute, Cutoff current = 100mA, DC500V 50MΩ min (At Room Temperature)					
	OPERATING TEMP.,HUMID.AND ALTIITUDE	-10 to +60°C, 20 - 90%RH (Non condensing) (Refer to DERATING CURVE) 3.000m (10.000feet) max					
	STORAGE TEMP.,HUMID.AND ALTIITUDE	-20 to +75°C, 20 - 90%RH (Non condensing) 9.000m (30.000feet) max					
	VIBRATION	10 - 55Hz, 19.6m/s ² (2G), 3minutes period, 60minutes each along X, Y and Z axis					
SAFETY AND NOISE REGULATIONS	IMPACT	196.1m/s ² (20G), 11ms, once each X, Y and Z axis					
	AGENCY APPROVALS	UL60950-1, EN60950-1, EN50178, CSA C22.2 No.60950-1 Complies with DEN-AN and IEC60950-1					
	CONDUCTED NOISE	Complies with FCC-B, CISPR22-B, EN55022-B, VCCI-B					
OTHERS	CASE SIZE/WEIGHT	55 X 26 X 133mm (W X H X D) /200g max (without chassis and cover)					
	COOLING METHOD	Convection					

*1 Drift is the change in DC output for an eight hour period after a half-hour warm-up at 25°C, with the input voltage held constant at the rated input/output.
 *2 Please contact us about safety approvals for the model with option.
 * Avoid prolonged use under over-load.
 * Series/Parallel operation with other model is not possible.
 * Derating is required when operated with chassis and cover.

External view

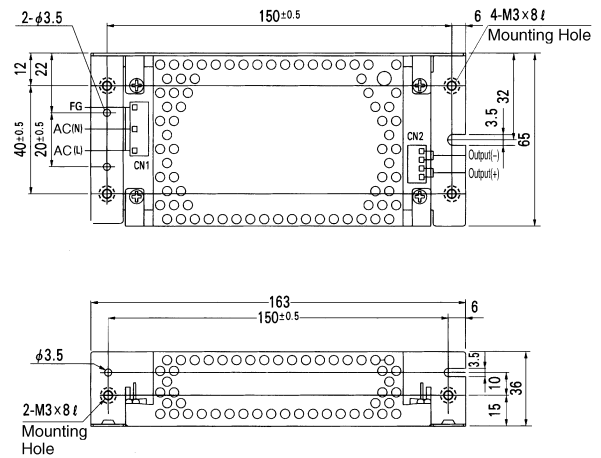

I/O Connector	Mating Connector	Terminal
CN1	B3P5-VH	VHR-5N
		Chain:SVH-21T-P1.1 Loose:BVH-21T-P1.1
CN2	B4P-VH	VHR-4N
		Chain:SVH-21T-P1.1 Loose:BVH-21T-P1.1

(Mfr : J.S.T.)

<PIN CONNECTION>

Pin No.	Input
1	AC(L)
2	
3	AC(N)
4	
5	FG

Pin No.	Output
1	-V
2	-V
3	+V
4	+V

- ※ Weight : 200g or less (Without chassis and cover)
- ※ Tolerance : ± 1
- ※ Dimensions in mm.
- ※ PCB Material : Glass composite (CEM3)
- ※ Chassis and cover is optional.
- ※ Mounting torque : 0.6N·m (6.3kgf·cm) max

※ Keep drawing current per pin below 5A for CN2.

LDA

Performance data

■ STATIC CHARACTERISTICS (LDA30F-5)



■ RISE TIME & FALL TIME (LDA30F-5)



■ OVERCURRENT CHARACTERISTICS (LDA30F-5)



■ DERATING CURVE



LDA50F

LDA 50 F -5 -□

① ② ③ ④ ⑤



Recommended EMI/EMC Filter
NAC-06-472



High voltage pulse noise type : NAP series
Low leakage current type : NAM series
*The EMI/EMC Filter is recommended to connect with several devices.

- ① Series name
- ② Output wattage
- ③ Universal input
- ④ Output voltage
- ⑤ Optional *4
- C :with Coating
- G :Low leakage current
- R :with Remote ON/OFF
- S :with Chassis
- SN :with Chassis & cover
- Y :with Potentiometer

MODEL	LDA50F-3	LDA50F-5	LDA50F-9	LDA50F-12	LDA50F-15	LDA50F-18	LDA50F-24	LDA50F-24-H	LDA50F-24-HR	LDA50F-30
MAX OUTPUT WATTAGE[W]	30	50	50.4	51.6	52.5	50.4	50.4	50.4	50.4	51
DC OUTPUT	*3 3V 10A	5V 10A	9V 5.6A	12V 4.3A	15V 3.5A	18V 2.8A	24V 2.1A	24V 2.1(3)A	24V 2.1(3)A	30V 1.7A

SPECIFICATIONS

	MODEL	LDA50F-3	LDA50F-5	LDA50F-9	LDA50F-12	LDA50F-15	LDA50F-18	LDA50F-24	LDA50F-24-H	LDA50F-24-HR	LDA50F-30	
INPUT	VOLTAGE[V]	AC85 - 264 1 φ or DC110 - 370										
	CURRENT[A]	ACIN 100V	1.3typ (Io=100%)									
		ACIN 200V	0.7typ (Io=100%)									
	FREQUENCY[Hz]	47 - 440 or DC										
	EFFICIENCY[%]	73typ	77typ	78typ	80typ	81typ	81typ	82typ	82typ	82typ	82typ	
	INRUSH CURRENT[A]	ACIN 100V	15typ (Io=100%) (At cold start)									
		ACIN 200V	30typ (Io=100%) (At cold start)									
LEAKAGE CURRENT[mA]	0.75max (60Hz, According to UL, CSA, VDE and DEN-AN)											
OUTPUT	VOLTAGE[V]	3	5	9	12	15	18	24	24	24	30	
	CURRENT[A]	*1 10	10	5.6	4.3	3.5	2.8	2.1	2.1 (3)	2.1 (3)	1.7	
	LINE REGULATION[mV]	20max	20max	36max	48max	60max	72max	96max	96max	96max	120max	
	LOAD REGULATION[mV]	40max	40max	100max	100max	120max	120max	150max	150max	150max	180max	
	RIPPLE[mVp-p]	0 to +50°C	80max	80max	120max	120max	120max	120max	120max	120max	120max	
		-10 - 0°C	140max	140max	160max	160max	160max	160max	160max	160max	160max	
	RIPPLE NOISE[mVp-p]	0 to +50°C	120max	120max	150max	150max	150max	150max	150max	250max	250max	
		-10 - 0°C	160max	160max	180max	180max	180max	180max	180max	280max	280max	
	TEMPERATURE REGULATION[mV]	60max	60max	120max	150max	180max	200max	290max	290max	290max	360max	
	DRIFT[mV]	*2 20max	20max	36max	48max	60max	72max	96max	96max	96max	120max	
	START-UP TIME[ms]	200max (ACIN 100V, Io=100%)										
	HOLD-UP TIME[ms]	10typ (ACIN 85V, Io=100%) 20typ (ACIN 100V, Io=100%)										
	OUTPUT VOLTAGE ADJUSTMENT RANGE[V]	2.85 - 3.6 Fixed ("Y" which can be adjusted the output is available as option :5, 9, 12, 15, 18, 24, 30V ±10%)										
OUTPUT VOLTAGE SETTING[V]	—	4.9 - 5.3	8.6 - 9.4	11.5 - 12.5	14.4 - 15.6	17.3 - 18.7	23.0 - 25.0	23.0 - 25.0	23.0 - 25.0	28.5 - 31.5		
PROTECTION CIRCUIT AND OTHERS	OVERCURRENT PROTECTION	Works over 105% of rating (-H : peak) and recovers automatically										
	OVERVOLTAGE PROTECTION	4.00 - 5.25V Works at 115 - 140% of rating										
	OPERATING INDICATION	Not provided										
	REMOTE SENSING	Not provided										
ISOLATION	REMOTE ON/OFF	Option (Refer to Instruction Manual)										
	INPUT-OUTPUT	AC3.000V 1minute, Cutoff current = 10mA, DC500V 50MΩ min (At Room Temperature)										
ENVIRONMENT	INPUT-FG	AC2.000V 1minute, Cutoff current = 10mA, DC500V 50MΩ min (At Room Temperature)										
	OUTPUT-FG	AC500V 1minute, Cutoff current = 100mA, DC500V 50MΩ min (At Room Temperature)										
SAFETY AND NOISE REGULATIONS	OPERATING TEMP., HUMID. AND ALTITUDE	-10 to +60°C, 20 - 90%RH (Non condensing) (Refer to DERATING CURVE) 3.000m (10.000feet) max										
	STORAGE TEMP., HUMID. AND ALTITUDE	-20 to +75°C, 20 - 90%RH (Non condensing) 9.000m (30.000feet) max										
	VIBRATION	10 - 55Hz, 19.6m/s ² (2G), 3minutes period, 60minutes each along X, Y and Z axis										
OTHERS	IMPACT	196.1m/s ² (20G), 11ms, once each X, Y and Z axis										
	AGENCY APPROVALS	UL60950-1, EN60950-1, EN50178, CSA C22.2 No.60950-1 Complies with DEN-AN and IEC60950-1										
OTHERS	CONDUCTED NOISE	Complies with FCC-B, CISPR22-B, EN55022-B, VCCI-B										
	CASE SIZE/WEIGHT	55 X 26 X 195mm (W X H X D) /250g max (without chassis and cover)										
	COOLING METHOD	Convection										

*1 Peak load for 10sec. or less is acceptable if the total wattage is less than the rated wattage(24V:50.4W).
 *2 Drift is the change in DC output for an eight hour period after a half-hour warm-up at 25°C, with the input voltage held constant at the rated input/output.
 *3 () : peak current
 *4 Please contact us about safety approvals for the model with option.

* Avoid prolonged use under over-load.
 * Parallel operation with other model is not possible.
 * Derating is required when operated with chassis and cover.

External view



I/O Connector	Mating Connector	Terminal
CN1	B3P5-VH	VHR-5N
CN2	B4P-VH	VHR-4N
CN3	B2B-XH-A	XHP-2

<PIN CONNECTION>

Pin No.	Input
1	AC(L)
2	
3	AC(N)
4	
5	FG

Pin No.	Output
1	-V
2	-V
3	+V
4	+V

Pin No.	Remote ON/OFF
1	RC(+)
2	RC(-)

※ Keep drawing current per pin below 5A for CN2.

- ※ Weight : 250g or less (Without chassis and cover)
- ※ Tolerance : ±1
- ※ Dimensions in mm.
- ※ PCB Material : Glass composite (CEM3)
- ※ Chassis and cover is optional.
- ※ Mounting torque : 0.6N·m (6.3kgf·cm) max

Performance data

■ STATIC CHARACTERISTICS (LDA50F-5)



■ RISE TIME & FALL TIME (LDA50F-5)



■ OVERCURRENT CHARACTERISTICS (LDA50F-5)



■ DERATING CURVE



LDA75F

LDA 75 F -5 -□

① ② ③ ④ ⑤



Recommended EMI/EMC Filter
NAC-06-472



High voltage pulse noise type : NAP series
Low leakage current type : NAM series
*The EMI/EMC Filter is recommended to connect with several devices.

- ① Series name
- ② Output wattage
- ③ Universal input
- ④ Output voltage
- ⑤ Optional *4
- C :with Coating
- G :Low leakage current
- L :with LED
- R :with Remote ON/OFF
- S :with Chassis
- SN :with Chassis & cover
- Y :with Potentiometer



MODEL	LDA75F-3	LDA75F-5	LDA75F-9	LDA75F-12	LDA75F-15	LDA75F-18	LDA75F-24	LDA75F-24-H	LDA75F-24-HR	LDA75F-30
MAX OUTPUT WATTAGE[W]	45	75	76.5	75.6	75	75.6	76.8	76.8	76.8	75
DC OUTPUT	*3 3V 15A	5V 15A	9V 8.5A	12V 6.3A	15V 5A	18V 4.2A	24V 3.2A	24V 3.2(4.5)A	24V 3.2(4.5)A	30V 2.5A

SPECIFICATIONS

MODEL	LDA75F-3	LDA75F-5	LDA75F-9	LDA75F-12	LDA75F-15	LDA75F-18	LDA75F-24	LDA75F-24-H	LDA75F-24-HR	LDA75F-30														
INPUT	VOLTAGE[V]											AC85 - 264 1 φ or DC110 - 370												
	CURRENT[A]		ACIN 100V											1.8typ (Io=100%)										
			ACIN 200V											1.0typ (Io=100%)										
	FREQUENCY[Hz]											47 - 440												
	EFFICIENCY[%]											73typ 79typ 79typ 80typ 81typ 81typ 82typ 82typ 82typ 82typ												
	INRUSH CURRENT[A]		ACIN 200V											30typ (Io=100%) (At cold start)										
LEAKAGE CURRENT[mA]											0.75max (60Hz, According to UL, CSA, VDE and DEN-AN)													
OUTPUT	VOLTAGE[V]		3		5		9		12		15		18		24		24		24		30			
	CURRENT[A]		*1 15		15		8.5		6.3		5		4.2		3.2		3.2 (4.5)		3.2 (4.5)		2.5			
	LINE REGULATION[mV]		20max		20max		36max		48max		60max		72max		96max		96max		96max		120max			
	LOAD REGULATION[mV]		40max		40max		100max		100max		120max		120max		150max		150max		150max		180max			
	RIPPLE[mVp-p]		0 to +50°C		80max		80max		120max		120max		120max		120max		120max		120max		120max			
			-10 - 0°C		140max		140max		160max		160max		160max		160max		160max		160max		160max			
	RIPPLE NOISE[mVp-p]		0 to +50°C		120max		120max		150max		150max		150max		150max		150max		250max		250max		150max	
			-10 - 0°C		160max		160max		180max		180max		180max		180max		180max		280max		280max		180max	
	TEMPERATURE REGULATION[mV]		60max		60max		120max		150max		180max		200max		290max		290max		290max		360max			
	DRIFT[mV]		*2 20max		20max		36max		48max		60max		72max		96max		96max		96max		120max			
START-UP TIME[ms]		200max (ACIN 100V, Io=100%)																						
HOLD-UP TIME[ms]		10typ (ACIN 85V, Io=100%) 20typ (ACIN 100V, Io=100%)																						
OUTPUT VOLTAGE ADJUSTMENT RANGE[V]		2.85 - 3.6 Fixed ("Y"which can be adjusted the output is available as option : 5, 9, 12, 15, 18, 24, 30V ±10%)																						
OUTPUT VOLTAGE SETTING[V]		— 4.9 - 5.3 8.6 - 9.4 11.5 - 12.5 14.4 - 15.6 17.3 - 18.7 23.0 - 25.0 23.0 - 25.0 23.0 - 25.0 28.5 - 31.5																						
PROTECTION CIRCUIT AND OTHERS	OVERCURRENT PROTECTION											Works over 105% of rating (-H : peak) and recovers automatically												
	OVERVOLTAGE PROTECTION											4.00 - 5.25V Works at 115 - 140% of rating												
	OPERATING INDICATION											Not provided												
	REMOTE SENSING											Not provided												
REMOTE ON/OFF											Option (Refer to Instruction Manual)													
ISOLATION	INPUT-OUTPUT											AC3,000V 1minute, Cutoff current = 10mA, DC500V 50MΩ min (At Room Temperature)												
	INPUT-FG											AC2,000V 1minute, Cutoff current = 10mA, DC500V 50MΩ min (At Room Temperature)												
OUTPUT-FG											AC500V 1minute, Cutoff current = 100mA, DC500V 50MΩ min (At Room Temperature)													
ENVIRONMENT	OPERATING TEMP.,HUMID.AND ALTITUDE											-10 to +60°C, 20 - 90%RH (Non condensing) (Refer to DERATING CURVE) 3,000m (10,000feet) max												
	STORAGE TEMP.,HUMID.AND ALTITUDE											-20 to +75°C, 20 - 90%RH (Non condensing) 9,000m (30,000feet) max												
	VIBRATION											10 - 55Hz, 19.6m/s ² (2G), 3minutes period, 60minutes each along X, Y and Z axis												
	IMPACT											196.1m/s ² (20G), 11ms, once each X, Y and Z axis												
SAFETY AND NOISE REGULATIONS	AGENCY APPROVALS											UL60950-1, EN60950-1, EN50178, CSA C22.2 No.60950-1 Complies with DEN-AN and IEC60950-1												
	CONDUCTED NOISE											Complies with FCC-B, CISPR22-B, EN55022-B, VCCI-B												
OTHERS	CASE SIZE/WEIGHT											55 X 32 X 222mm (W X H X D) /320g max (without chassis and cover)												
	COOLING METHOD											Convection												

*1 Peak load for 10sec. or less is acceptable if the total wattage is less than the rated wattage(24V:76.8W).
 *2 Drift is the change in DC output for an eight hour period after a half-hour warm-up at 25°C,with the input voltage held constant at the rated input/output.
 *3 () : peak current
 *4 Please contact us about safety approvals for the model with option.

* Avoid prolonged use under over-load.
 * Parallel operation with other model is not possible.
 * Derating is required when operated with chassis and cover.

External view



I/O Connector	Mating Connector	Terminal
CN1	B3P5-VH	VHR-5N Chain: SVH-21T-P1.1 Loose: BVH-21T-P1.1
CN2	B6P-VH	VHR-6N Chain: SVH-21T-P1.1 Loose: BVH-21T-P1.1
CN3	B2B-XH-A	XHP-2 Chain: SXH-001T-P0.6 Loose: BXH-001T-P0.6

<PIN CONNECTION>

Pin No.	Input
1	AC(L)
2	
3	AC(N)
4	
5	FG

Pin No.	Output
1~3	-V
4~6	+V

Pin No.	Remote ON/OFF
1	RC(+)
2	RC(-)

※Keep drawing current per pin below 5A for CN2.

- ※ Weight : 320g or less (Without chassis and cover)
- ※ Tolerance : ± 1
- ※ Dimensions in mm.
- ※ PCB Material : Glass composite (CEM3)
- ※ Chassis and cover is optional.
- ※ Mounting torque : 1.5 N·m (16 kgf·cm) max

Performance data

■ STATIC CHARACTERISTICS (LDA75F-5)



■ RISE TIME & FALL TIME (LDA75F-5)



■ OVERCURRENT CHARACTERISTICS (LDA75F-5)



■ DERATING CURVE



LDA100W

LDA 100 W -5 -□

① ② ③ ④ ⑤



Recommended EMI/EMC Filter
NAC-06-472



High voltage pulse noise type : NAP series
Low leakage current type : NAM series
*The EMI/EMC Filter is recommended to connect with several devices.

- ① Series name
- ② Output wattage
- ③ Autoranging input
- ④ Output voltage
- ⑤ Optional *4
- C :with Coating
- G :Low leakage current
- R :with Remote ON/OFF
- S :with Chassis
- SN :with Chassis & cover
- Y :with Potentiometer



MODEL	LDA100W-3	LDA100W-5	LDA100W-9	LDA100W-12	LDA100W-15	LDA100W-18	LDA100W-24	LDA100W-24-H	LDA100W-30	LDA100W-48
MAX OUTPUT WATTAGE[W]	60	100	103.5	102	100.5	100.8	103.2	103.2	105	96
DC OUTPUT	*3 3V 20A	5V 20A	9V 11.5A	12V 8.5A	15V 6.7A	18V 5.6A	24V 4.3A	24V 4.3(6.5)A	30V 3.5A	48V 2.0A

SPECIFICATIONS

MODEL	LDA100W-3	LDA100W-5	LDA100W-9	LDA100W-12	LDA100W-15	LDA100W-18	LDA100W-24	LDA100W-24-H	LDA100W-30	LDA100W-48																
INPUT	VOLTAGE[V]											AC 85 - 132 / 170 - 264 1 φ														
	CURRENT[A]		ACIN 100V											2.4typ (Io=100%)												
			ACIN 200V											1.2typ (Io=100%)												
	FREQUENCY[Hz]											47 - 440														
	EFFICIENCY[%]											75typ 79typ 80typ 81typ 82typ 82typ 83typ 83typ 83typ 82typ														
	INRUSH CURRENT[A]		ACIN 200V											30typ (Io=100%) (At cold start)												
LEAKAGE CURRENT[mA]											0.75max (60Hz, According to UL, CSA, VDE and DEN-AN)															
OUTPUT	VOLTAGE[V]		3		5		9		12		15		18		24		24		30		48					
	CURRENT[A]		*1 20		20		11.5		8.5		6.7		5.6		4.3		4.3 (6.5)		3.5		2.0					
	LINE REGULATION[mV]		20max		20max		36max		48max		60max		72max		96max		96max		120max		192max					
	LOAD REGULATION[mV]		40max		40max		100max		100max		120max		120max		150max		150max		180max		240max					
	RIPPLE[mVp-p]		0 to +50°C		80max		80max		120max		120max		120max		120max		120max		120max		150max					
			-10 - 0°C		140max		140max		160max		160max		160max		160max		160max		160max		200max					
	RIPPLE NOISE[mVp-p]		0 to +50°C		120max		120max		150max		150max		150max		150max		150max		250max		150max		400max			
			-10 - 0°C		160max		160max		180max		180max		180max		180max		180max		280max		180max		600max			
	TEMPERATURE REGULATION[mV]		60max		60max		120max		150max		180max		200max		290max		290max		360max		560max					
	DRIFT[mV]		*2 20max		20max		36max		48max		60max		72max		96max		96max		120max		192max					
START-UP TIME[ms]		200max (ACIN 100V, Io=100%)																								
HOLD-UP TIME[ms]		10typ (ACIN 85V, Io=100%) 20typ (ACIN 100V, Io=100%)																								
OUTPUT VOLTAGE ADJUSTMENT RANGE[V]		2.85 - 3.6		4.5 - 5.5		Fixed ("Y"which can be adjusted the output is available as option :9, 12, 15, 18, 24, 30, 48V ±10%)																				
OUTPUT VOLTAGE SETTING[V]		—		—		8.6 - 9.4		11.5 - 12.5		14.4 - 15.6		17.3 - 18.7		23.0 - 25.0		23.0 - 25.0		28.8 - 31.2		46.0 - 50.0						
PROTECTION CIRCUIT AND OTHERS	OVERCURRENT PROTECTION		Works over 105% of rating (-H : peak) and recovers automatically																							
	OVERVOLTAGE PROTECTION		4.00 - 5.25V Works at 115 - 140% of rating																							
	OPERATING INDICATION		Not provided																							
	REMOTE SENSING		Not provided																							
REMOTE ON/OFF		Option (Refer to Instruction Manual)																								
ISOLATION	INPUT-OUTPUT		AC3,000V 1minute, Cutoff current = 10mA, DC500V 50MΩ min (At Room Temperature)																							
	INPUT-FG		AC2,000V 1minute, Cutoff current = 10mA, DC500V 50MΩ min (At Room Temperature)																							
	OUTPUT-FG		AC500V 1minute, Cutoff current = 100mA, DC500V 50MΩ min (At Room Temperature)																							
ENVIRONMENT	OPERATING TEMP.,HUMID.AND ALTIITUDE		-10 to +60°C, 20 - 90%RH (Non condensing) (Refer to DERATING CURVE) 3,000m (10,000feet) max																							
	STORAGE TEMP.,HUMID.AND ALTIITUDE		-20 to +75°C, 20 - 90%RH (Non condensing) 9,000m (30,000feet) max																							
	VIBRATION		10 - 55Hz, 19.6m/s ² (2G), 3minutes period, 60minutes each along X, Y and Z axis																							
	IMPACT		196.1m/s ² (20G), 11ms, once each X, Y and Z axis																							
SAFETY AND NOISE REGULATIONS	AGENCY APPROVALS		UL60950-1, EN60950-1, EN50178, CSA C22.2 No.234 Complies with DEN-AN and IEC60950-1																							
	CONDUCTED NOISE		Complies with FCC-B, CISPR22-B, EN55022-B, VCCI-B																							
OTHERS	CASE SIZE/WEIGHT		62X35X222mm (WxHxD) /360g max (without chassis and cover)																							
	COOLING METHOD		Convection																							

*1 Peak load for 20sec. or less is acceptable if the total wattage is less than the rated wattage(24V:103.2W).
 *2 Drift is the change in DC output for an eight hour period after a half-hour warm-up at 25°C, with the input voltage held constant at the rated input/output.
 *3 () : peak current
 *4 Please contact us about safety approvals for the model with option.

* Avoid prolonged use under over-load.
 * Parallel operation with other model is not possible.
 * Derating is required when operated with chassis and cover.

External view

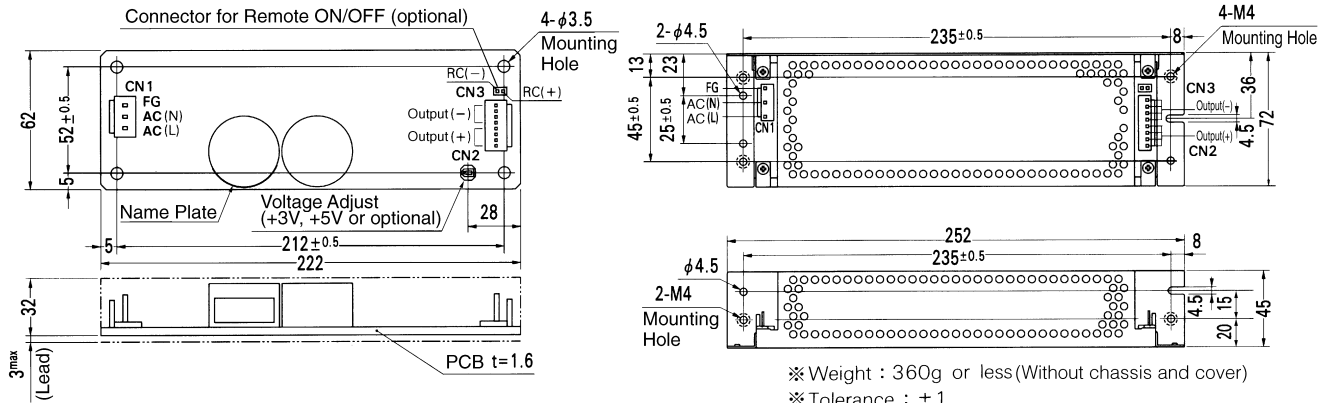

- ※ Weight : 360g or less (Without chassis and cover)
- ※ Tolerance : ± 1
- ※ Dimensions in mm.
- ※ PCB Material : Glass composite (CEM3)
- ※ Chassis and cover is optional.
- ※ Mounting torque : 1.5 N·m (16 kgf·cm) max

I/O Connector	Mating Connector	Terminal	
CN1	B3P5-VH	VHR-5N	Chain: SVH-21T-P1.1
			Loose: BVH-21T-P1.1
CN2	B8P-VH	VHR-8N	Chain: SVH-21T-P1.1
			Loose: BVH-21T-P1.1
CN3	B2B-XH-A	XHP-2	Chain: SXH-001T-P0.6
			Loose: BXH-001T-P0.6

(Mfr : J.S.T.)

<PIN CONNECTION>

CN1	Pin No.	Input	CN2	Pin No.	Output	CN3	Pin No.	Remote ON/OFF
	1	AC(L)		1~4	-V		1	RC(+)
2						2	RC(-)	
3	AC(N)		5~8	+V				
4								
5	FG							

※ Keep drawing current per pin below 5A for CN2.

Performance data

■ STATIC CHARACTERISTICS (LDA100W-5)



■ RISE TIME & FALL TIME (LDA100W-5)

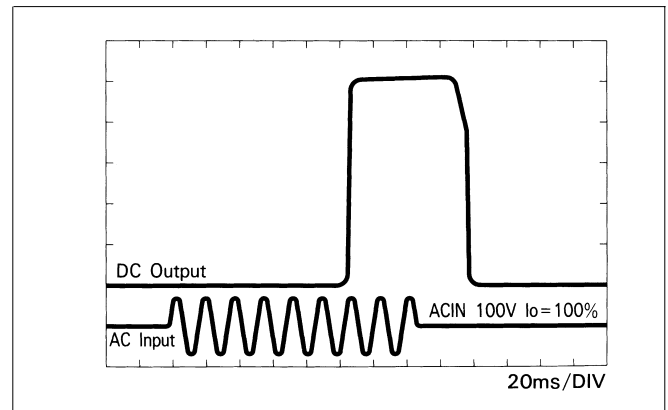

■ OVERCURRENT CHARACTERISTICS (LDA100W-5)



■ DERATING CURVE

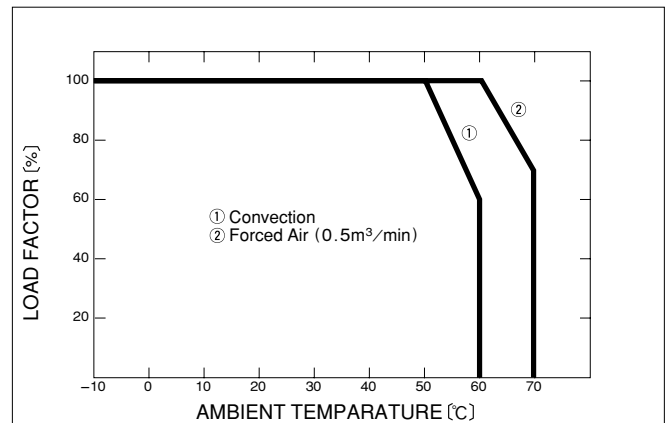

LDA150W

LDA 150 W -5 -□

① ② ③ ④ ⑤



RoHS



Recommended EMI/EMC Filter
NAC-06-472



High voltage pulse noise type : NAP series
Low leakage current type : NAM series
*The EMI/EMC Filter is recommended to connect with several devices.

- ① Series name
- ② Output wattage
- ③ Autoranging input
- ④ Output voltage
- ⑤ Optional *4
- C :with Coating
- G :Low leakage current
- L :with LED
- R :with Remote ON/OFF
- S :with Chassis
- SN :with Chassis & cover
- Y :with Potentiometer

MODEL	LDA150W-3	LDA150W-5	LDA150W-9	LDA150W-12	LDA150W-15	LDA150W-18	LDA150W-24	LDA150W-24-H	LDA150W-30	LDA150W-48
MAX OUTPUT WATTAGE[W]	90	150	153	150	150	153	151.2	151.2	150	144
DC OUTPUT	*3 3V 30A	5V 30A	9V 17A	12V 12.5A	15V 10A	18V 8.5A	24V 6.3A	24V 6.3(10)A	30V 5A	48V 3A

SPECIFICATIONS

MODEL	LDA150W-3	LDA150W-5	LDA150W-9	LDA150W-12	LDA150W-15	LDA150W-18	LDA150W-24	LDA150W-24-H	LDA150W-30	LDA150W-48																					
INPUT	VOLTAGE[V]											AC 85 - 132 / 170 - 264 1 φ																			
	CURRENT[A]		ACIN 100V											3.6typ (Io=100%)																	
			ACIN 200V											2.0typ (Io=100%)																	
	FREQUENCY[Hz]											47 - 440																			
	EFFICIENCY[%]											75typ		79typ		79typ		82typ		83typ		84typ		85typ		85typ		85typ		82typ	
	INRUSH CURRENT[A]		ACIN 200V											30typ (Io=100%) (At cold start)																	
LEAKAGE CURRENT[mA]											0.75max (60Hz, According to UL, CSA, VDE and DEN-AN)																				
OUTPUT	VOLTAGE[V]		3		5		9		12		15		18		24		24		30		48										
	CURRENT[A]		*1 30		30		17		12.5		10		8.5		6.3		6.3(10)		5		3										
	LINE REGULATION[mV]		20max		20max		36max		48max		60max		72max		96max		96max		120max		192max										
	LOAD REGULATION[mV]		40max		40max		100max		100max		120max		120max		150max		150max		180max		240max										
	RIPPLE[mVp-p]		0 to +50°C		80max		80max		120max		120max		120max		120max		220max		220max		150max										
			-10 - 0°C		140max		140max		160max		160max		160max		160max		160max		260max		160max		200max								
	RIPPLE NOISE[mVp-p]		0 to +50°C		120max		120max		150max		150max		150max		150max		150max		250max		150max		400max								
			-10 - 0°C		160max		160max		180max		180max		180max		180max		180max		280max		180max		600max								
	TEMPERATURE REGULATION[mV]		60max		60max		120max		150max		180max		200max		290max		290max		360max		560max										
	DRIFT[mV]		*2 20max		20max		36max		48max		60max		72max		96max		96max		120max		192max										
START-UP TIME[ms]		200max (ACIN 100V, Io=100%)																													
HOLD-UP TIME[ms]		10typ (ACIN 85V, Io=100%) 20typ (ACIN 100V, Io=100%)																													
OUTPUT VOLTAGE ADJUSTMENT RANGE[V]		2.85 - 3.6		4.5 - 5.5		Fixed ("Y" which can be adjusted the output is available as option :9, 12, 15, 18, 24, 30, 48V ±10%)																									
OUTPUT VOLTAGE SETTING[V]		—		—		8.6 - 9.4		11.5 - 12.5		14.4 - 15.6		17.3 - 18.7		23.0 - 25.0		23.0 - 25.0		28.5 - 31.5		46.0 - 50.0											
PROTECTION CIRCUIT AND OTHERS	OVERCURRENT PROTECTION		Works over 105% of rating (-H : peak) and recovers automatically																												
	OVERVOLTAGE PROTECTION		4.00 - 5.25V		Works at 115 - 140% of rating																										
	OPERATING INDICATION		Not provided																												
	REMOTE SENSING		Not provided																												
REMOTE ON/OFF		Option (Refer to Instruction Manual)																													
ISOLATION	INPUT-OUTPUT		AC3,000V 1minute, Cutoff current = 10mA, DC500V 50MΩ min (At Room Temperature)																												
	INPUT-FG		AC2,000V 1minute, Cutoff current = 10mA, DC500V 50MΩ min (At Room Temperature)																												
OUTPUT-FG		AC500V 1minute, Cutoff current = 100mA, DC500V 50MΩ min (At Room Temperature)																													
ENVIRONMENT	OPERATING TEMP., HUMID. AND ALTITUDE		-10 to +60°C, 20 - 90%RH (Non condensing) (Refer to DERATING CURVE) 3,000m (10,000feet) max																												
	STORAGE TEMP., HUMID. AND ALTITUDE		-20 to +75°C, 20 - 90%RH (Non condensing) 9,000m (30,000feet) max																												
	VIBRATION		10 - 55Hz, 19.6m/s ² (2G), 3minutes period, 60minutes each along X, Y and Z axis																												
IMPACT		196.1m/s ² (20G), 11ms, once each X, Y and Z axis																													
SAFETY AND NOISE REGULATIONS	AGENCY APPROVALS		UL60950-1, EN60950-1, EN50178, CSA C22.2 No.234 Complies with DEN-AN and IEC60950-1																												
	CONDUCTED NOISE		Complies with FCC-B, CISPR22-B, EN55022-B, VCCI-B																												
OTHERS	CASE SIZE/WEIGHT		75×37×222mm (W×H×D) /510g max (without chassis and cover)																												
	COOLING METHOD		Convection																												

*1 Peak load for 10sec. or less is acceptable if the total wattage is less than the rated wattage(24V:151.2W).

*2 Drift is the change in DC output for an eight hour period after a half-hour warm-up at 25°C, with the input voltage held constant at the rated input/output.

*3 () : peak current

*4 Please contact us about safety approvals for the model with option.

* Avoid prolonged use under over-load.

* Parallel operation with other model is not possible.

* Derating is required when operated with chassis and cover.

External view



I/O Connector	Mating Connector	Terminal
CN1	B3P5-VH	VHR-5N Chain: SVH-21T-P1.1 Loose: BVH-21T-P1.1
CN2	B6P-VH	VHR-6N Chain: SVH-21T-P1.1 Loose: BVH-21T-P1.1
CN3	B7P-VH	VHR-7N Chain: SVH-21T-P1.1 Loose: BVH-21T-P1.1
CN4	B2B-XH-A	XHP-2 Chain: SXH-001T-P0.6 Loose: BXH-001T-P0.6

(Mfr : J.S.T.)

<PIN CONNECTION>

Pin No.	Input	Pin No.	Output	Pin No.	Remote ON/OFF
1	AC(L)	CN2	1~6	CN4	1
2					
3	AC(N)	CN3	1~7	2	RC(-)
4					
5	FG				

※ Keep drawing current per pin below 5A for CN2, CN3.

※ Weight : 510g or less
(Without chassis and cover)

※ Tolerance : ±1

※ Dimensions in mm.

※ PCB Material : Glass composite (CEM3)

※ Chassis and cover is optional.

※ Chassis and cover is not available to remote ON/OFF unit.

※ Mounting torque : 1.5 N·m (16 kgf·cm) max

LDA

Performance data

■ STATIC CHARACTERISTICS (LDA150W-5)

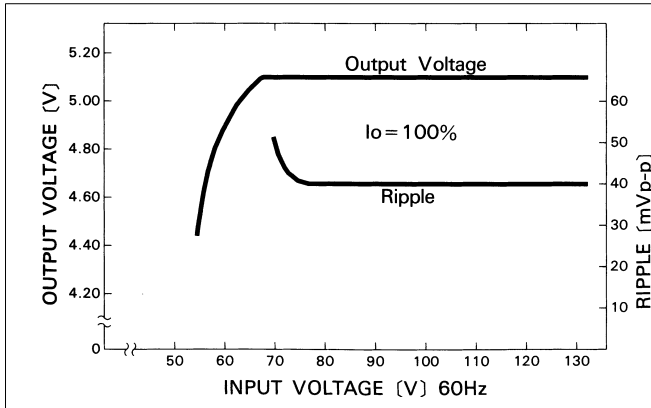

■ RISE TIME & FALL TIME (LDA150W-5)

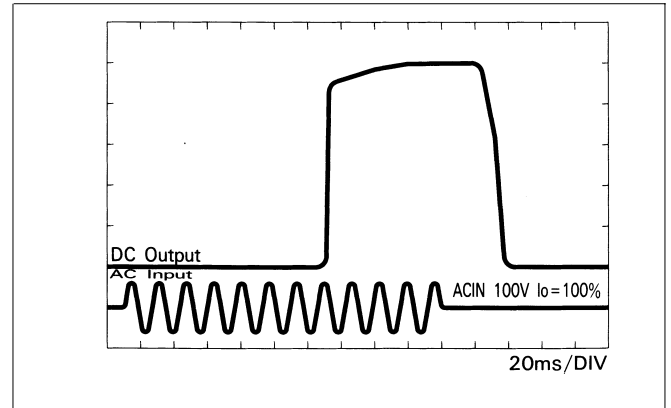

■ OVERCURRENT CHARACTERISTICS (LDA150W-5)

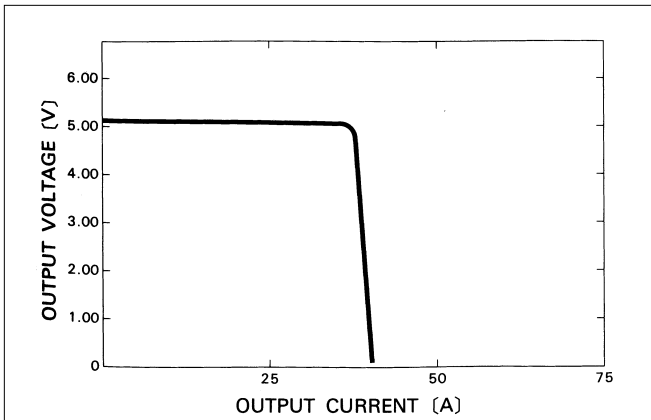

■ DERATING CURVE

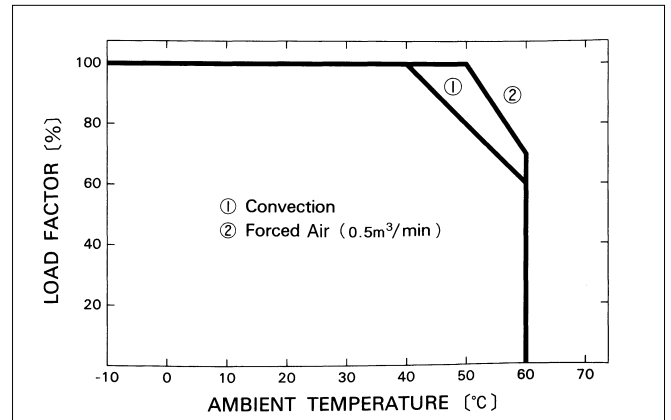

LDA300W

LDA 300 W -5 -□

① ② ③ ④ ⑤



Recommended EMI/EMC Filter
NAC-16-472



High voltage pulse noise type : NAP series
Low leakage current type : NAM series
*The EMI/EMC Filter is recommended to connect with several devices.

- ① Series name
- ② Output wattage
- ③ Autoranging input
- ④ Output voltage
- ⑤ Optional *4
- C :with Coating
- G :Low leakage current
- L :with LED
- R :with Remote ON/OFF
- S :with Chassis
- SNF :with Chassis & cover & fan
- T :Vertical terminal block

MODEL	LDA300W-3	LDA300W-5	LDA300W-9	LDA300W-12	LDA300W-15	LDA300W-18	LDA300W-24	LDA300W-30	LDA300W-48
MAX OUTPUT WATTAGE[W]	180	300	306	324	330	306	336	300	302.4
DC OUTPUT	3V 60A	5V 60A	9V 34A	12V 27A	15V 22A	18V 17A	24V 14A	30V 10A	48V 6.3A

SPECIFICATIONS

	MODEL	LDA300W-3	LDA300W-5	LDA300W-9	LDA300W-12	LDA300W-15	LDA300W-18	LDA300W-24	LDA300W-30	LDA300W-48	
INPUT	VOLTAGE[V]	AC 85 - 132 / 170 - 264 1 φ									
	CURRENT[A]	ACIN 100V	7.5typ (Io=100%)								
		ACIN 200V	4.5typ (Io=100%)								
	FREQUENCY[Hz]	47 - 440									
	EFFICIENCY[%]	ACIN 100V	72typ	78typ	78typ	80typ	81typ	81typ	83typ	83typ	83typ
		ACIN 200V	74typ	81typ	81typ	83typ	84typ	84typ	86typ	86typ	86typ
INRUSH CURRENT[A]	ACIN 100V	15/30A typ (Primary/Secondary Surge Current) Io=100% (More than 3sec.to re-start)									
	ACIN 200V	30/30typ (Primary/Secondary Surge Current) Io=100% (More than 3sec.to re-start)									
LEAKAGE CURRENT[mA]	0.75max (60Hz, According to UL, CSA, VDE and DEN-AN)										
OUTPUT	VOLTAGE[V]	3	5	9	12	15	18	24	30	48	
	CURRENT[A]	Forced air	60	60	34	27	22	17	14	10	6.3
		Convection*1	40 (60)	40 (60)	23 (34)	17 (27)	14 (22)	12 (17)	9 (14)	7 (10)	4.2 (6.3)
	LINE REGULATION[mV]	20max	20max	36max	48max	60max	72max	96max	120max	192max	
	LOAD REGULATION[mV]	40max	40max	100max	100max	120max	120max	150max	180max	240max	
	RIPPLE[mVp-p]	0 to +50°C*2	80max	80max	120max	120max	120max	120max	120max	120max	150max
		-10 - 0°C*2	140max	140max	160max	160max	160max	160max	160max	160max	200max
	RIPPLE NOISE[mVp-p]	0 to +50°C*2	120max	120max	150max	150max	150max	150max	150max	150max	400max
		-10 - 0°C*2	160max	160max	180max	180max	180max	180max	180max	180max	600max
	TEMPERATURE REGULATION[mV]	60max	60max	120max	150max	180max	200max	290max	360max	560max	
	DRIFT[mV]	*3	20max	20max	36max	48max	60max	72max	96max	120max	192max
START-UP TIME[ms]	200max (ACIN 100V, Io=100%)										
HOLD-UP TIME[ms]	10typ (ACIN 85V, Io=100%) 20typ (ACIN 100V, Io=100%)										
OUTPUT VOLTAGE ADJUSTMENT RANGE[V]	2.85 - 3.6 5. 9, 12, 15, 18, 24, 30, 48V ±10%										
PROTECTION CIRCUIT AND OTHERS	OVERCURRENT PROTECTION	Works over 105% of rating and recovers automatically									
	OVERVOLTAGE PROTECTION	4.00 - 5.25V Works at 115 - 140% of rating									
	OPERATING INDICATION	Not provided									
	REMOTE SENSING	Provided									
ISOLATION	REMOTE ON/OFF	Option (Refer to Instruction Manual)									
	INPUT-OUTPUT	AC3.000V 1minute, Cutoff current = 10mA, DC500V 50MΩ min (At Room Temperature)									
ENVIRONMENT	INPUT-FG	AC2.000V 1minute, Cutoff current = 10mA, DC500V 50MΩ min (At Room Temperature)									
	OUTPUT-FG	AC500V 1minute, Cutoff current = 100mA, DC500V 50MΩ min (At Room Temperature)									
SAFETY AND NOISE REGULATIONS	OPERATING TEMP.,HUMID.AND ALTIITUDE	-10 to +70°C, 20 - 90%RH (Non condensing) (Refer to DERATING CURVE) 3.000m (10.000feet) max									
	STORAGE TEMP.,HUMID.AND ALTIITUDE	-20 to +75°C, 20 - 90%RH (Non condensing) 9.000m (30.000feet) max									
	VIBRATION	10 - 55Hz, 19.6m/s ² (2G), 3minutes period, 60minutes each along X, Y and Z axis									
OTHERS	IMPACT	196.1m/s ² (20G), 11ms, once each X, Y and Z axis									
	AGENCY APPROVALS	UL60950-1, C-UL, EN60950-1, EN50178 Complies with DEN-AN and IEC60950-1									
OTHERS	CONDUCTED NOISE	Complies with FCC-B, CISPR22-B, EN55022-B, VCCI-B									
	CASE SIZE/WEIGHT	108×50×255mm (W×H×D) /1kg max (without terminal block)									
OTHERS	COOLING METHOD	Convection / Forced air (Refer to DERATING CURVE)									

*1 Peak load for 30sec. or less is acceptable if the total wattage is less than the rated wattage.
 *2 This is the value that measured on measuring board with capacitor of 22 μF within 150mm from output terminal.
 *3 Drift is the change in DC output for an eight hour period after a half-hour warm-up at 25°C, with the input voltage held constant at the rated input/output.
 *4 Please contact us about safety approvals for the model with option.
 * Parallel operation with other model is not possible.
 * Derating is required when operated with chassis and cover.

External view



Standard Model

Horizontal type

Vertical type

Optional Model "-T"
(Ex. LDA300W-5-T)

Optional Model "-SNF"
(EX. LDA300W-5-SNF)

Applicable options

Terminal Block Horizontal type		Terminal Block Vertical type	
-S	Available	-ST	Available
-SN	Not Available	-SNT	Not Available
-SNF	Available 5V, 12V, 24V	-SNFT	Not Available

CN1 (Connector for Sensing)
Type: B4B-XH-A

Pin No.	Function
1	-M
2	-S (Remote Sensing)
3	+S (Remote Sensing)
4	+M

Mating Housing & Pin
Mfr: J. S. T.
XHP-4(BXH-001T-P0.6 or SXH-001T-P0.6)

CN2 (Optional connector for Remote ON/OFF: optional)
Type: B2B-XH-A

Pin No.	Function
1	RC (+)
2	RC (-)

Mating Housing & Pin
Mfr: J. S. T.
XHP-2(BXH-001T-P0.6 or SXH-001T-P0.6)

- ※ Weight : 1kg or less (without casecover)
- ※ Tolerance : ±1
- ※ Dimensions : mm.
- ※ PCB Material : Glass composite (CEM3)
- ※ Keep drawing current per pin below 20A for TB2
- ※ Mounting torque : 1.5N·m (16kgf·cm) max

LDA

Performance data

■ STATIC CHARACTERISTICS (LDA300W-5)



■ RISE TIME & FALL TIME (LDA300W-5)



■ OVERCURRENT CHARACTERISTICS (LDA300W-5)



■ DERATING CURVE



Mouser Electronics

Authorized Distributor

Click to View Pricing, Inventory, Delivery & Lifecycle Information:

Cosel:

[S-LDA300](#) [N-LDA75](#) [N-LDA150](#) [N-LDA10](#) [S-LDA15](#) [N-LDA30](#) [S-LDA150](#) [S-LDA50](#) [S-LDA10](#) [N-LDA100](#) [S-LDA100](#) [N-LDA50](#) [S-LDA75](#) [S-LDA30](#) [N-LDA15](#) [LDA50F-5-SNR](#) [LDA100W-24-H](#) [LDA100W-30-SNY](#) [LDA30F-24-SNG](#) [LDA75F-12-S](#) [LDA50F-12-Y](#) [LDA75F-24-SY](#) [LDA150W-9-RY](#) [LDA300W-5-RT](#) [LDA10F-12-SNY](#) [LDA150W-48-SN](#) [LDA100W-48](#) [LDA30F-12-SY](#) [LDA50F-24-GY](#) [LDA300W-3-CT](#) [LDA300W-24-R](#) [LDA150W-12-CR](#) [LDA75F-5-CY](#) [LDA10F-24-M](#) [LDA50F-24-S](#) [LDA30F-24](#) [LDA100W-15-RY](#) [LDA15F-5-GY](#) [LDA150W-18](#) [LDA15F-15-GY](#) [LDA10F-3-SNC](#) [LDA75F-12-M](#) [LDA150W-24-CR](#) [LDA50F-12-R](#) [LDA75F-24-R](#) [LDA75F-30-SNR](#) [LDA50F-3-M](#) [LDA30F-24-SN](#) [LDA15F-3-S](#) [LDA75F-5-V](#) [LDA75F-15-Y](#) [LDA300W-3-R](#) [LDA10F-15-SNQ](#) [LDA50F-24-SN](#) [LDA100W-9-Y](#) [LDA50F-15-SN](#) [LDA150W-30-TD28](#) [LDA300W-48-S](#) [LDA30F-15-SNY](#) [LDA50F-9-SNC](#) [LDA10F-5-S](#) [LDA75F-9-SN](#) [LDA150W-5-L](#) [LDA150W-30](#) [LDA300W-30-CT](#) [LDA150W-12-Y](#) [LDA100W-48-SNY](#) [LDA150W-3-C](#) [LDA30F-5-Y](#) [LDA75F-12-SNY](#) [LDA30F-12-G](#) [LDA75F-24-C](#) [LDA100W-12-SNRY](#) [LDA300W-24-C](#) [LDA100W-24-SNH](#) [LDA15F-5-Q](#) [LDA50F-30](#) [LDA75F-15](#) [LDA75F-9-Y](#) [LDA50F-5-G](#) [LDA30F-3-SNC](#) [LDA15F-24-CG](#) [LDA10F-5-SNC](#) [LDA30F-3-GD3.3](#) [LDA50F-24-CR](#) [LDA100W-48-CY](#) [LDA100W-5-CR](#) [LDA150W-24-SHY](#) [LDA10F-24-SNY](#) [LDA75F-3-SN](#) [LDA50F-30-SNRY](#) [LDA10F-5-SNY](#) [LDA300W-24-L](#) [LDA100W-5-SNC](#) [LDA300W-30-R](#) [LDA15F-12-S](#) [LDA100W-24-HY](#) [LDA50F-24-HY](#) [LDA50F-5-Y](#) [LDA15F-12-Y](#)



Компания «ЭлектроПласт» предлагает заключение долгосрочных отношений при поставках импортных электронных компонентов на взаимовыгодных условиях!

Наши преимущества:

- Оперативные поставки широкого спектра электронных компонентов отечественного и импортного производства напрямую от производителей и с крупнейших мировых складов;
- Поставка более 17-ти миллионов наименований электронных компонентов;
- Поставка сложных, дефицитных, либо снятых с производства позиций;
- Оперативные сроки поставки под заказ (от 5 рабочих дней);
- Экспресс доставка в любую точку России;
- Техническая поддержка проекта, помощь в подборе аналогов, поставка прототипов;
- Система менеджмента качества сертифицирована по Международному стандарту ISO 9001;
- Лицензия ФСБ на осуществление работ с использованием сведений, составляющих государственную тайну;
- Поставка специализированных компонентов (Xilinx, Altera, Analog Devices, Intersil, Interpoint, Microsemi, Aeroflex, Peregrine, Syfer, Eurofarad, Texas Instrument, Miteq, Cobham, E2V, MA-COM, Hittite, Mini-Circuits, General Dynamics и др.);

Помимо этого, одним из направлений компании «ЭлектроПласт» является направление «Источники питания». Мы предлагаем Вам помощь Конструкторского отдела:

- Подбор оптимального решения, техническое обоснование при выборе компонента;
- Подбор аналогов;
- Консультации по применению компонента;
- Поставка образцов и прототипов;
- Техническая поддержка проекта;
- Защита от снятия компонента с производства.



Как с нами связаться

Телефон: 8 (812) 309 58 32 (многоканальный)

Факс: 8 (812) 320-02-42

Электронная почта: org@eplast1.ru

Адрес: 198099, г. Санкт-Петербург, ул. Калинина, дом 2, корпус 4, литера А.