

Sonic Fast Recovery Diode

preliminary

$$V_{RRM} = 1800 \text{ V}$$

$$I_{FAV} = 20 \text{ A}$$

$$t_{rr} = 300 \text{ ns}$$

High Performance Fast Recovery Diode
 Low Loss and Soft Recovery
 Single Diode

Part number

DH20-18A

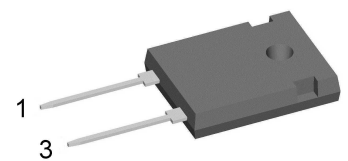

Backside: cathode

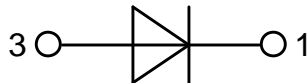

Features / Advantages:

- Planar passivated chips
- Very low leakage current
- Very short recovery time
- Improved thermal behaviour
- Very low I_{rm} -values
- Very soft recovery behaviour
- Avalanche voltage rated for reliable operation
- Soft reverse recovery for low EMI/RFI
- Low I_{rm} reduces:
 - Power dissipation within the diode
 - Turn-on loss in the commutating switch

Applications:

- Antiparallel diode for high frequency switching devices
- Antisaturation diode
- Snubber diode
- Free wheeling diode
- Rectifiers in switch mode power supplies (SMPS)
- Uninterruptible power supplies (UPS)

Package: TO-247

- Industry standard outline
- RoHS compliant
- Epoxy meets UL 94V-0

Terms Conditions of usage:

The data contained in this product data sheet is exclusively intended for technically trained staff. The user will have to evaluate the suitability of the product for the intended application and the completeness of the product data with respect to his application. The specifications of our components may not be considered as an assurance of component characteristics. The information in the valid application- and assembly notes must be considered. Should you require product information in excess of the data given in this product data sheet or which concerns the specific application of your product, please contact your local sales office.

Due to technical requirements our product may contain dangerous substances. For information on the types in question please contact your local sales office.

Should you intend to use the product in aviation, in health or life endangering or life support applications, please notify. For any such application we urgently recommend

- to perform joint risk and quality assessments;

- the conclusion of quality agreements;

- to establish joint measures of an ongoing product survey, and that we may make delivery dependent on the realization of any such measures.

Fast Diode				Ratings			
Symbol	Definition	Conditions	min.	typ.	max.	Unit	
V_{RSM}	max. non-repetitive reverse blocking voltage				1800	V	
V_{RRM}	max. repetitive reverse blocking voltage				1800	V	
I_R	reverse current, drain current	$V_R = 1800\text{ V}$			50	μA	
		$V_R = 1800\text{ V}$			0.2	mA	
V_F	forward voltage drop	$I_F = 20\text{ A}$			2.24	V	
		$I_F = 40\text{ A}$			2.83	V	
		$I_F = 20\text{ A}$			2.35	V	
		$I_F = 40\text{ A}$			3.25	V	
I_{FAV}	average forward current	$T_C = 95^\circ\text{C}$			20	A	
		rectangular $d = 0.5$					
V_{FO}	threshold voltage	} for power loss calculation only			1.44	V	
r_F	slope resistance				43	m Ω	
R_{thJC}	thermal resistance junction to case				0.9	K/W	
R_{thCH}	thermal resistance case to heatsink			0.25		K/W	
P_{tot}	total power dissipation				140	W	
I_{FSM}	max. forward surge current	$t = 10\text{ ms}; (50\text{ Hz}), \text{ sine}; V_R = 0\text{ V}$			150	A	
C_J	junction capacitance	$V_R = 900\text{ V}$ $f = 1\text{ MHz}$			7	pF	
I_{RM}	max. reverse recovery current	} $I_F = 20\text{ A}; V_R = 900\text{ V}$			22	A	
					25	A	
t_{rr}	reverse recovery time	} $-di_F/dt = 400\text{ A}/\mu\text{s}$			300	ns	
					550	ns	

preliminary

Package TO-247			Ratings			
Symbol	Definition	Conditions	min.	typ.	max.	Unit
I_{RMS}	RMS current	per terminal			70	A
T_{VJ}	virtual junction temperature		-55		150	°C
T_{op}	operation temperature		-55		125	°C
T_{stg}	storage temperature		-55		150	°C
Weight				6		g
M_D	mounting torque		0.8		1.2	Nm
F_C	mounting force with clip		20		120	N

Product Marking

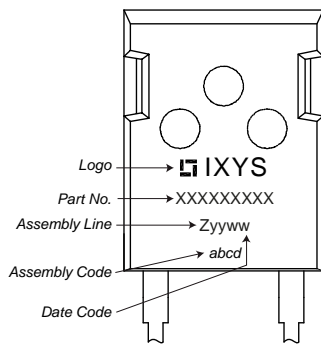

Ordering	Ordering Number	Marking on Product	Delivery Mode	Quantity	Code No.
Standard	DH20-18A	DH20-18A	Tube	30	499730

Equivalent Circuits for Simulation

* on die level

$T_{VJ} = 150\text{ °C}$

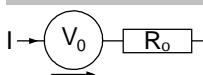

Fast Diode

$V_{0\ max}$	threshold voltage	1.44	V
$R_{0\ max}$	slope resistance *	40	mΩ

Outlines TO-247

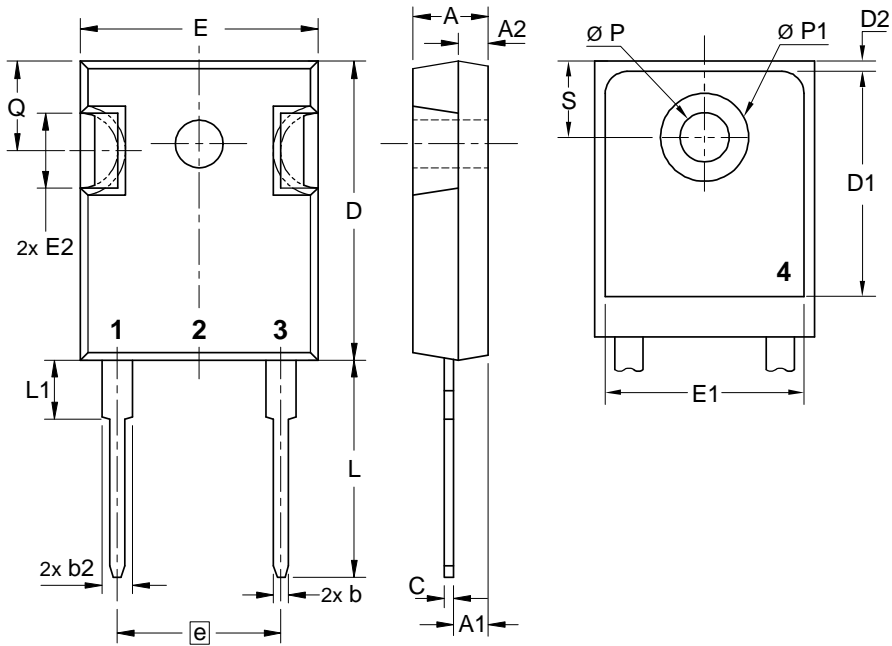

Sym.	Inches		Millimeter	
	min.	max.	min.	max.
A	0.185	0.209	4.70	5.30
A1	0.087	0.102	2.21	2.59
A2	0.059	0.098	1.50	2.49
D	0.819	0.845	20.79	21.45
E	0.610	0.640	15.48	16.24
E2	0.170	0.216	4.31	5.48
e	0.430 BSC		10.92 BSC	
L	0.780	0.800	19.80	20.30
L1	-	0.177	-	4.49
Ø P	0.140	0.144	3.55	3.65
Q	0.212	0.244	5.38	6.19
S	0.242 BSC		6.14 BSC	
b	0.039	0.055	0.99	1.40
b2	0.065	0.094	1.65	2.39
b4	0.102	0.135	2.59	3.43
c	0.015	0.035	0.38	0.89
D1	0.515	-	13.07	-
D2	0.020	0.053	0.51	1.35
E1	0.530	-	13.45	-
Ø P1	-	0.29	-	7.39

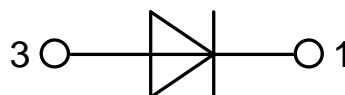

Fast Diode

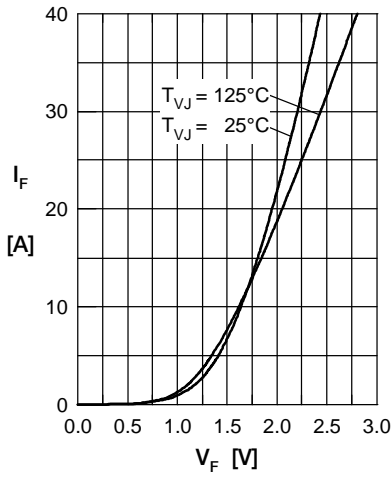

Fig. 1 Typ. Forward current versus V_F

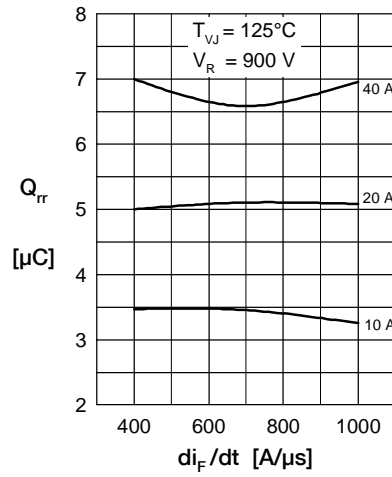

Fig. 2 Typ. reverse recov. charge Q_{rr} versus di/dt

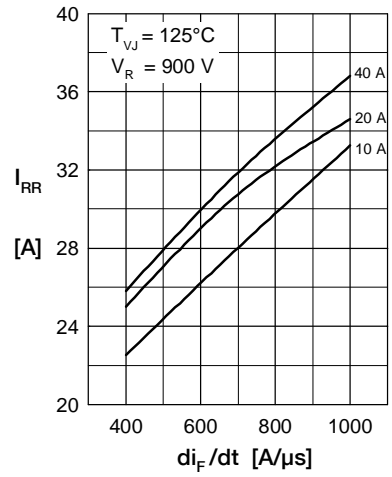

Fig. 3 Typ. peak reverse current I_{RM} versus di/dt

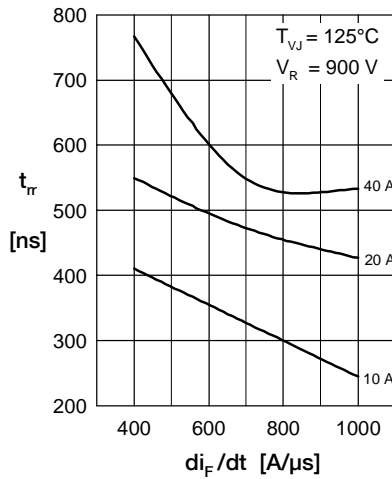

Fig. 4 Dynamic parameters Q_{rr} , I_{RM} versus T_{VJ}

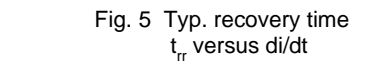

Fig. 5 Typ. recovery time t_{rr} versus di/dt

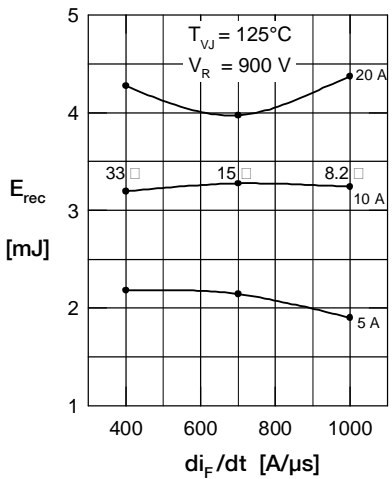

Fig. 6 Typ. recovery energy E_{rec} versus di/dt

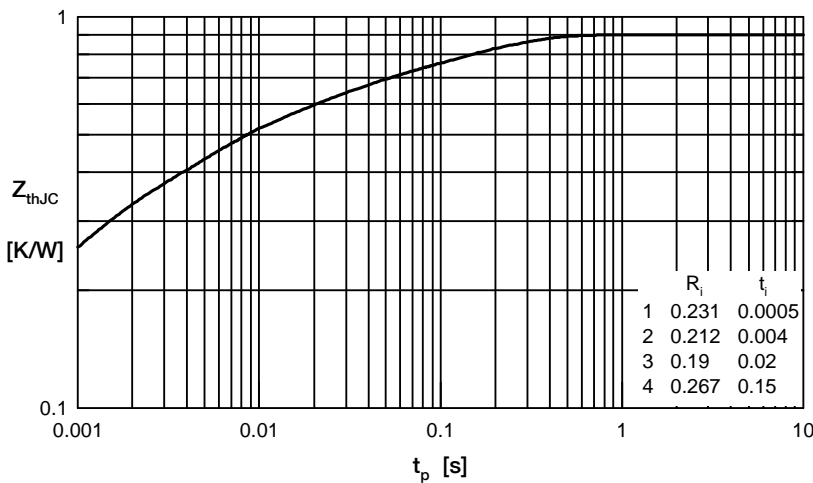

Fig. 7 Typ. transient thermal impedance junction to case



Компания «ЭлектроПласт» предлагает заключение долгосрочных отношений при поставках импортных электронных компонентов на взаимовыгодных условиях!

Наши преимущества:

- Оперативные поставки широкого спектра электронных компонентов отечественного и импортного производства напрямую от производителей и с крупнейших мировых складов;
- Поставка более 17-ти миллионов наименований электронных компонентов;
- Поставка сложных, дефицитных, либо снятых с производства позиций;
- Оперативные сроки поставки под заказ (от 5 рабочих дней);
- Экспресс доставка в любую точку России;
- Техническая поддержка проекта, помощь в подборе аналогов, поставка прототипов;
- Система менеджмента качества сертифицирована по Международному стандарту ISO 9001;
- Лицензия ФСБ на осуществление работ с использованием сведений, составляющих государственную тайну;
- Поставка специализированных компонентов (Xilinx, Altera, Analog Devices, Intersil, Interpoint, Microsemi, Aeroflex, Peregrine, Syfer, Eurofarad, Texas Instrument, Miteq, Cobham, E2V, MA-COM, Hittite, Mini-Circuits, General Dynamics и др.);

Помимо этого, одним из направлений компании «ЭлектроПласт» является направление «Источники питания». Мы предлагаем Вам помощь Конструкторского отдела:

- Подбор оптимального решения, техническое обоснование при выборе компонента;
- Подбор аналогов;
- Консультации по применению компонента;
- Поставка образцов и прототипов;
- Техническая поддержка проекта;
- Защита от снятия компонента с производства.



Как с нами связаться

Телефон: 8 (812) 309 58 32 (многоканальный)

Факс: 8 (812) 320-02-42

Электронная почта: org@eplast1.ru

Адрес: 198099, г. Санкт-Петербург, ул. Калинина, дом 2, корпус 4, литера А.