

SMD Multilayer Chip Bead

ACML-0201



RoHS
Compliant



0.6 x 0.3 x 0.3 mm

FREQUENCY RESPONSE

ACML-0201-600

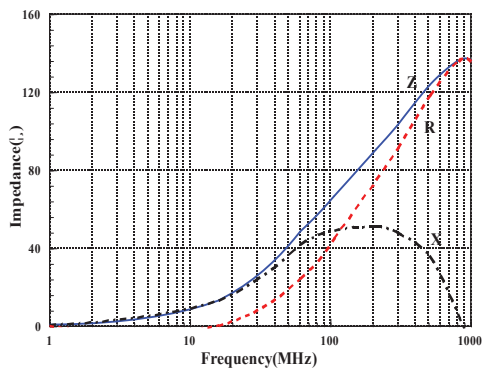

ACML-0201-800

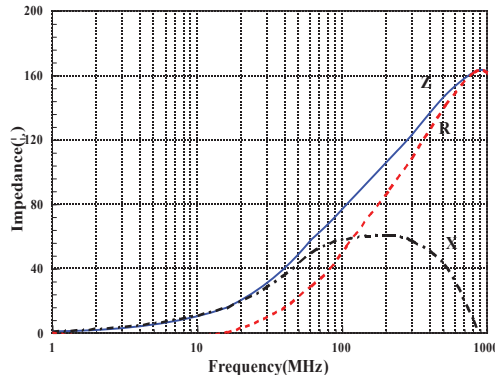

ACML-0201-121

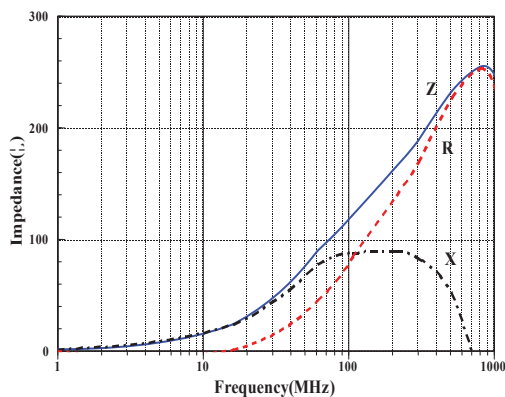

ACML-0201-241

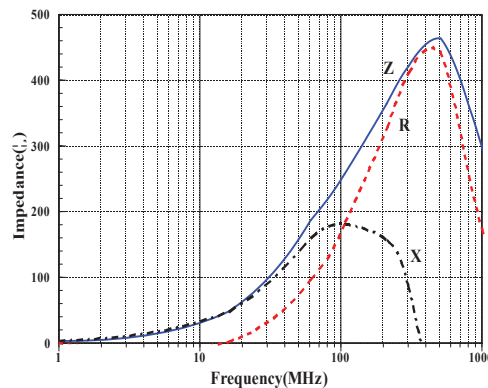

ACML-0201-471

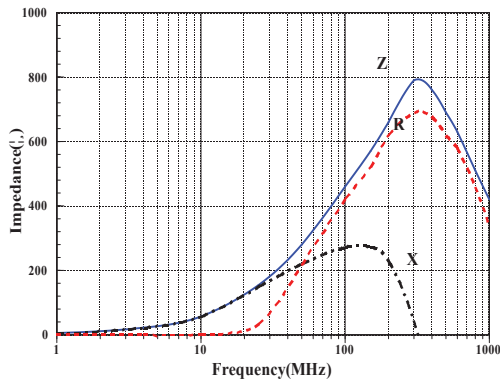

ACML-0201-601

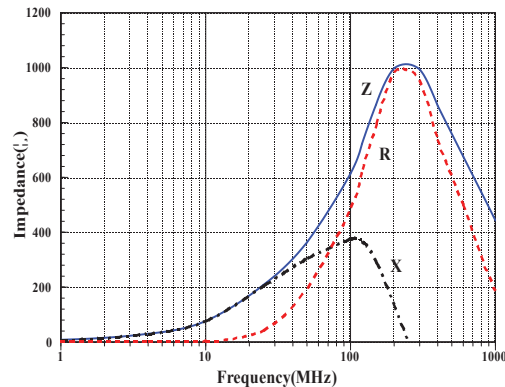

ABRACON IS
ISO 9001:2008
CERTIFIED



ABRACON
CORPORATION

Visit www.abracon.com for Terms & Conditions of Sale **Revised: 09.12.12**
30332 Esperanza, Rancho Santa Margarita, California 92688
tel 949-546-8000 | fax 949-546-8001 | www.abracon.com

SMD Multilayer Chip Bead

ACML-0201



RoHS
Compliant



0.6 x 0.3 x 0.3 mm

OUTLINE DRAWING:

Recommended Land Pattern

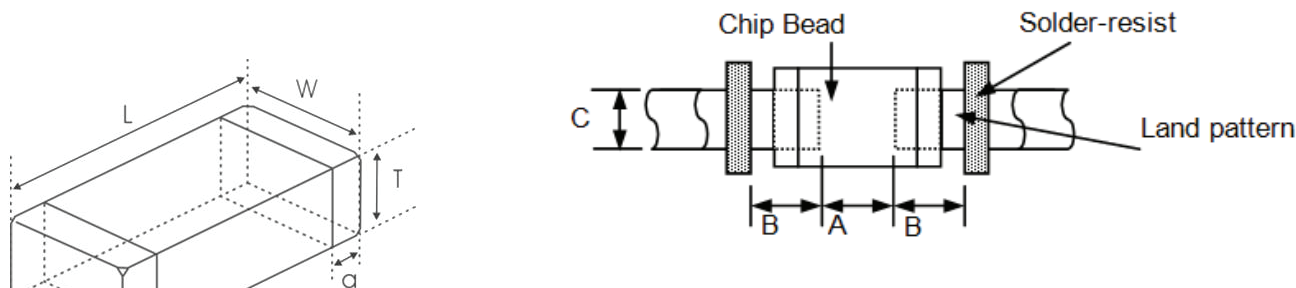

| A | B | C |
|---------|---------|----------|
| 0.2~0.3 | 0.2~0.3 | 0.3~0.35 |

| Series | L | W | T | a |
|-----------|---------------------------|---------------------------|---------------------------|----------------------------|
| ACML-0201 | 0.6±0.05 [0.024±0.002] | 0.3±0.05 [0.012±0.002] | 0.3±0.05 [0.012±0.002] | 0.15±0.05 [0.006±0.002] |

Dimension: mm [inch]

Materials

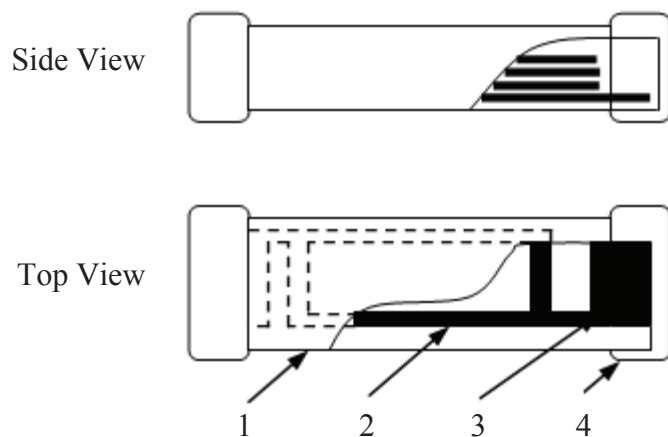

| | Part Name | Material |
|---|--------------------|---|
| 1 | Base Material | Ferrite |
| 2 | Internal Conductor | Ag |
| 3 | Pull out Electrode | Ag |
| 4 | Terminal Electrode | Ag (Inner layer) Ni-Sn (Outer layer) |

SMD Multilayer Chip Bead

ACML-0201



RoHS
Compliant

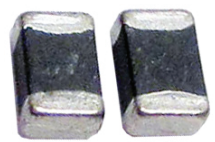

0.6 x 0.3 x 0.3 mm

REFLOW PROFILE:

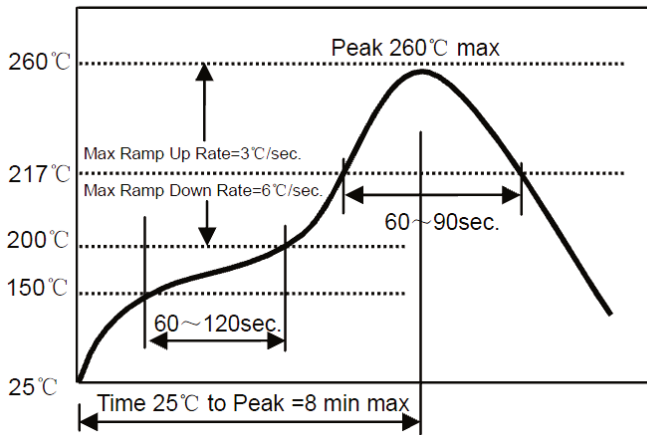

| | |
|-----------------------------|-------------------------------|
| Preheat Condition | 150 to 200 °C; 60 to 120 sec. |
| Albwd time above 217 °C | 60 to 90 sec. |
| Max temperature | 260 °C |
| Max time at max temperature | 10 sec. |
| Solder paste | Sn/3.0Ag/0.5Cu |
| Allowed Reflow time | 2x max. |

TAPE & REEL:

T: 15,000pcs / reel

Sprocket Hole $\Phi 1.5 (+0.1, -0.0)$

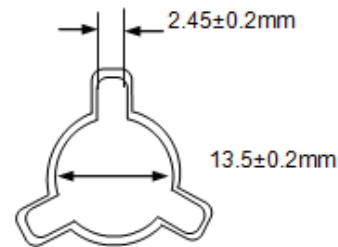
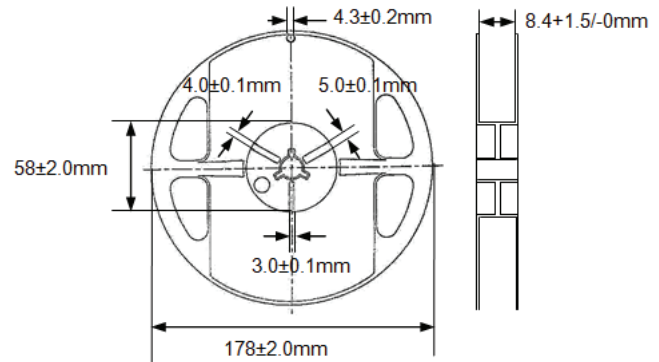
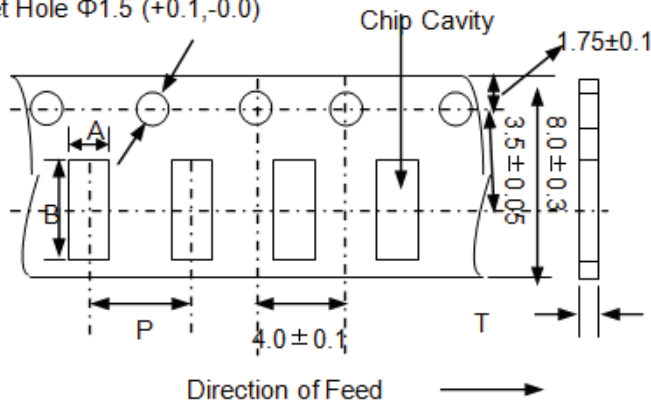

| A | B | P | t(max) |
|----------|----------|---------|--------|
| 0.40±0.1 | 0.70±0.1 | 2.0±0.1 | 0.55 |

Dimension: mm

ATTENTION: Abracon Corporation's products are COTS – Commercial-Off-The-Shelf products; suitable for Commercial, Industrial and, where designated, Automotive Applications. Abracon's products are not specifically designed for Military, Aviation, Aerospace, Life-dependant Medical applications or any application requiring high reliability where component failure could result in loss of life and/or property. For applications requiring high reliability and/or presenting an extreme operating environment, written consent and authorization from Abracon Corporation is required. Please contact Abracon Corporation for more information.

ABRACON IS
ISO 9001:2008
CERTIFIED



Visit www.abracon.com for Terms & Conditions of Sale **Revised: 09.12.12**
30332 Esperanza, Rancho Santa Margarita, California 92688
tel 949-546-8000 | fax 949-546-8001 | www.abracon.com



Компания «ЭлектроПласт» предлагает заключение долгосрочных отношений при поставках импортных электронных компонентов на взаимовыгодных условиях!

Наши преимущества:

- Оперативные поставки широкого спектра электронных компонентов отечественного и импортного производства напрямую от производителей и с крупнейших мировых складов;
- Поставка более 17-ти миллионов наименований электронных компонентов;
- Поставка сложных, дефицитных, либо снятых с производства позиций;
- Оперативные сроки поставки под заказ (от 5 рабочих дней);
- Экспресс доставка в любую точку России;
- Техническая поддержка проекта, помощь в подборе аналогов, поставка прототипов;
- Система менеджмента качества сертифицирована по Международному стандарту ISO 9001;
- Лицензия ФСБ на осуществление работ с использованием сведений, составляющих государственную тайну;
- Поставка специализированных компонентов (Xilinx, Altera, Analog Devices, Intersil, Interpoint, Microsemi, Aeroflex, Peregrine, Syfer, Eurofarad, Texas Instrument, Miteq, Cobham, E2V, MA-COM, Hittite, Mini-Circuits, General Dynamics и др.);

Помимо этого, одним из направлений компании «ЭлектроПласт» является направление «Источники питания». Мы предлагаем Вам помощь Конструкторского отдела:

- Подбор оптимального решения, техническое обоснование при выборе компонента;
- Подбор аналогов;
- Консультации по применению компонента;
- Поставка образцов и прототипов;
- Техническая поддержка проекта;
- Защита от снятия компонента с производства.



Как с нами связаться

Телефон: 8 (812) 309 58 32 (многоканальный)

Факс: 8 (812) 320-02-42

Электронная почта: org@eplast1.ru

Адрес: 198099, г. Санкт-Петербург, ул. Калинина, дом 2, корпус 4, литера А.