

# SMD Multilayer Chip Bead

ACML-0201



RoHS  
Compliant



0.6 x 0.3 x 0.3 mm

## FEATURES:

- Internal silver printed layers and magnetically shielded to minimize crosstalk
- Substantial EMI suppression over a wide frequency range
- Excellent solderability and heat resistance

## APPLICATIONS:

- Noise suppression for computers and peripheral devices, DVD cameras, LCD TVs, communication equipments, OA equipments, etc.
- Reduces noise in ultra high speed circuits as well

## STANDARD SPECIFICATIONS:

**Operating Temperature:** -55°C ~ +125°C

**Storage Temperature:** -10°C to +40°C, 70% RH max

Part No.	Z( $\Omega$ ) $\pm$ 25%	Z Test Freq.	DCR ( $\Omega$ )	Ir (mA)
		(MHz)	(max)	(max)
ACML-0201-600	60	100	0.40	200
ACML-0201-800	80	100	0.60	200
ACML-0201-121	120	100	0.80	200
ACML-0201-241	240	100	1.00	200
ACML-0201-471	470	100	1.40	200
ACML-0201-601	600	100	1.70	200

### Test Conditions and equipments

**Z:** High Accuracy RF Impedance/Material Analyzer -E4991A, 100MHz, -20dBm or 50mV

**DCR:** High Accuracy Milliohm meter -HP4338B

**Ir:** Electric Power Supply, Electric Current Meter, Thermometer.  $\Delta T \leq 20^\circ\text{C}$

**Unless otherwise specified, the standard atmospheric conditions for measurement/test as:**

- Ambient Temperature:  $20 \pm 15^\circ\text{C}$
- Relative Humidity:  $65\% \pm 20\%$
- Air Pressure: 86 KPa to 106 KPa

### Visual Examination

- Inspection Equipment: 20X magnifier

## OPTIONS AND PART IDENTIFICATION:

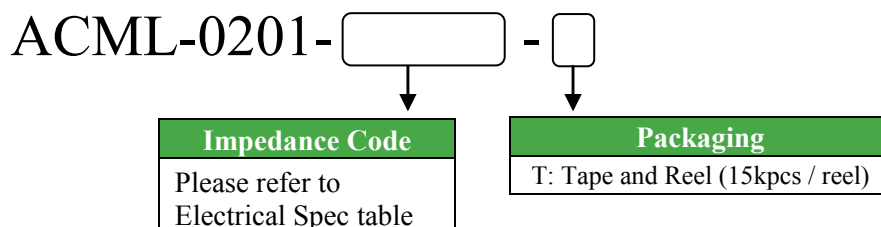

### Impedance Code

Please refer to  
Electrical Spec table

### Packaging

T: Tape and Reel (15kpcs / reel)

# SMD Multilayer Chip Bead

ACML-0201



RoHS  
Compliant

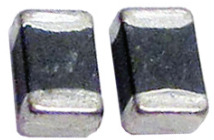

0.6 x 0.3 x 0.3 mm

## FREQUENCY RESPONSE

ACML-0201-600

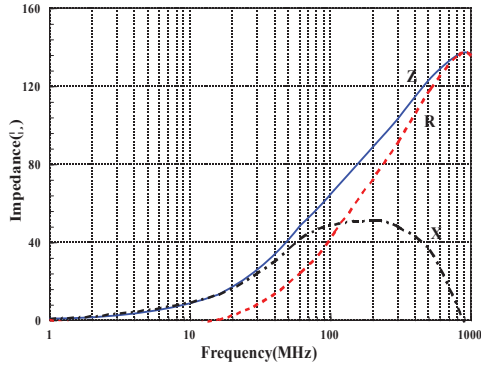

ACML-0201-800

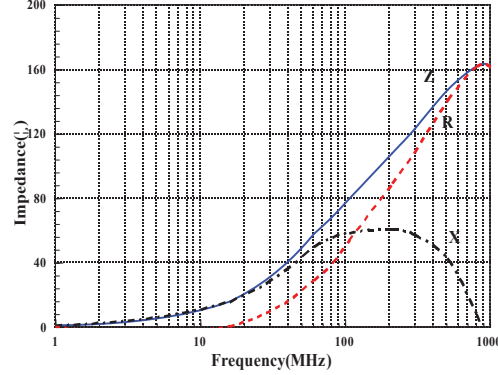

ACML-0201-121

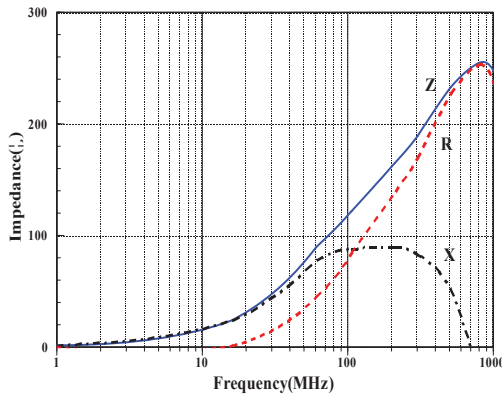

ACML-0201-241

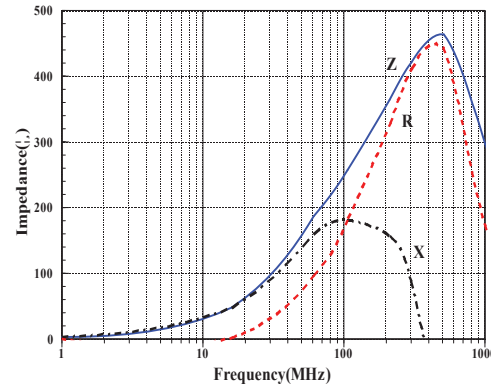

ACML-0201-471

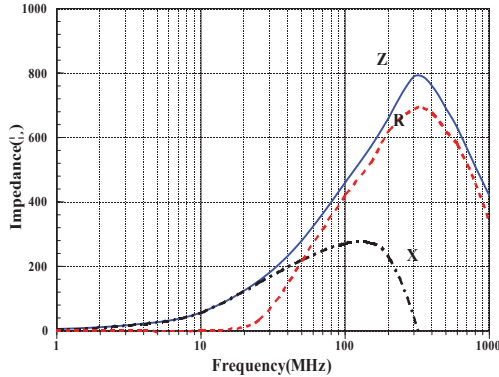

ACML-0201-601

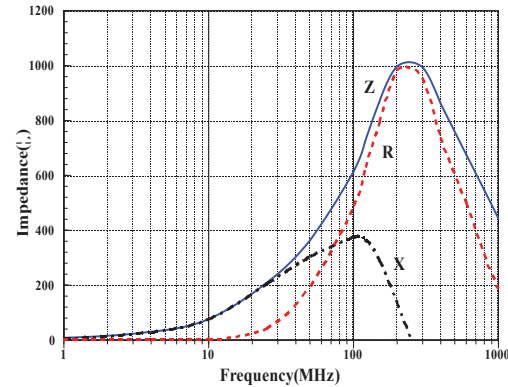

# SMD Multilayer Chip Bead

ACML-0201



RoHS  
Compliant



0.6 x 0.3 x 0.3 mm

## OUTLINE DRAWING:

### Recommended Land Pattern

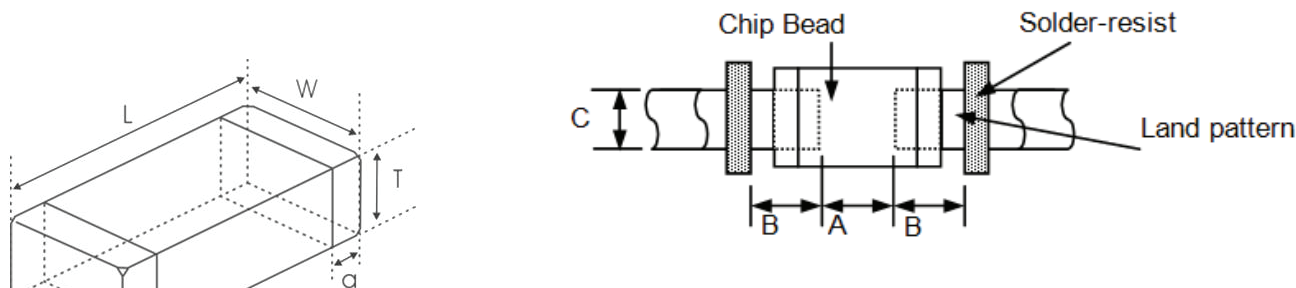

A	B	C
0.2~0.3	0.2~0.3	0.3~0.35

Series	L	W	T	a
ACML-0201	0.6±0.05 [0.024±0.002]	0.3±0.05 [0.012±0.002]	0.3±0.05 [0.012±0.002]	0.15±0.05 [0.006±0.002]

Dimension: mm [inch]

## Materials

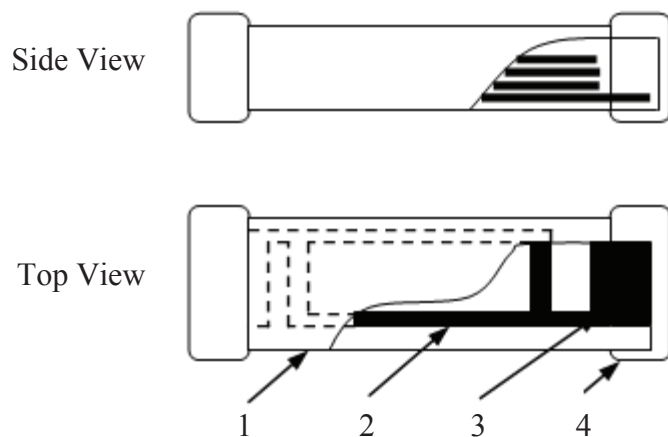

	Part Name	Material
1	Base Material	Ferrite
2	Internal Conductor	Ag
3	Pull out Electrode	Ag
4	Terminal Electrode	Ag (Inner layer) Ni-Sn (Outer layer)

# SMD Multilayer Chip Bead

**ACML-0201**



**RoHS  
Compliant**

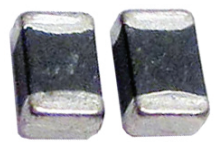

0.6 x 0.3 x 0.3 mm

## REFLOW PROFILE:

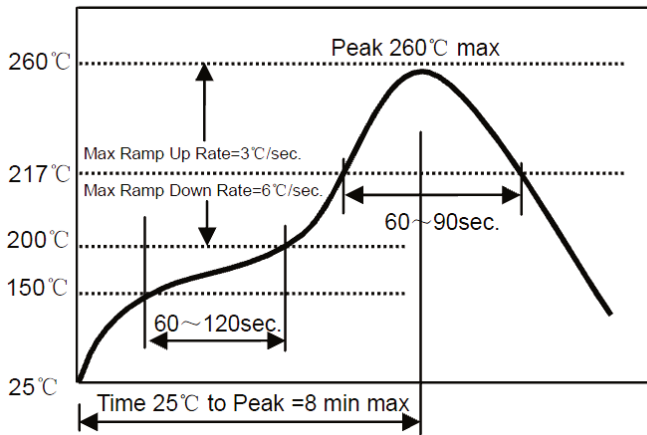

Preheat Condition	150 to 200 °C; 60 to 120 sec.
Albwd time above 217 °C	60 to 90 sec.
Max temperature	260 °C
Max time at max temperature	10 sec.
Solder paste	Sn/3.0Ag/0.5Cu
Allowed Reflow time	2x max.

## TAPE & REEL:

**T: 15,000pcs / reel**

Sprocket Hole  $\Phi 1.5 (+0.1, -0.0)$

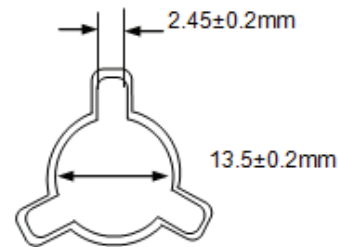
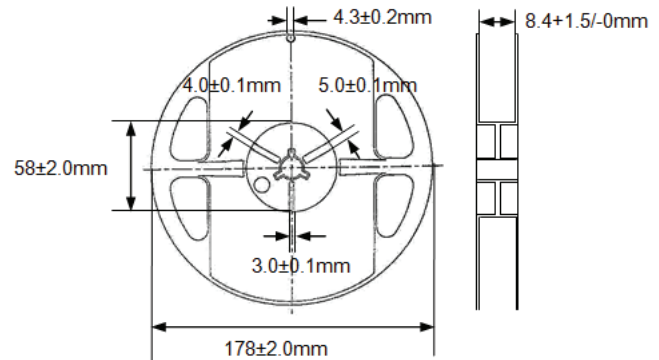
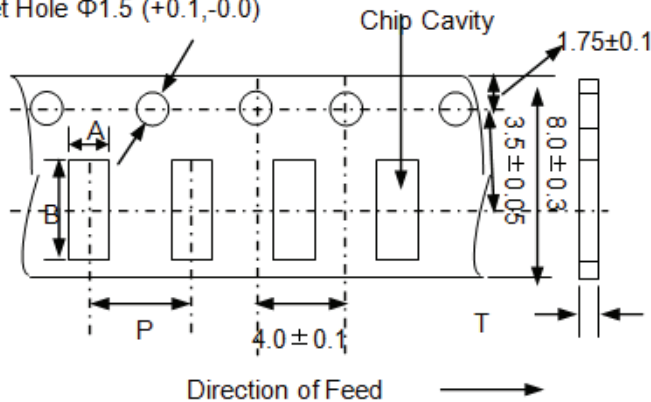

A	B	P	t(max)
0.40±0.1	0.70±0.1	2.0±0.1	0.55

**Dimension: mm**

**ATTENTION:** Abracon Corporation's products are COTS – Commercial-Off-The-Shelf products; suitable for Commercial, Industrial and, where designated, Automotive Applications. Abracon's products are not specifically designed for Military, Aviation, Aerospace, Life-dependant Medical applications or any application requiring high reliability where component failure could result in loss of life and/or property. For applications requiring high reliability and/or presenting an extreme operating environment, written consent and authorization from Abracon Corporation is required. Please contact Abracon Corporation for more information.

ABRACON IS  
ISO 9001:2008  
CERTIFIED



Visit [www.abracon.com](http://www.abracon.com) for Terms & Conditions of Sale **Revised: 09.12.12**  
30332 Esperanza, Rancho Santa Margarita, California 92688  
tel 949-546-8000 | fax 949-546-8001 | [www.abracon.com](http://www.abracon.com)



Компания «ЭлектроПласт» предлагает заключение долгосрочных отношений при поставках импортных электронных компонентов на взаимовыгодных условиях!

Наши преимущества:

- Оперативные поставки широкого спектра электронных компонентов отечественного и импортного производства напрямую от производителей и с крупнейших мировых складов;
- Поставка более 17-ти миллионов наименований электронных компонентов;
- Поставка сложных, дефицитных, либо снятых с производства позиций;
- Оперативные сроки поставки под заказ (от 5 рабочих дней);
- Экспресс доставка в любую точку России;
- Техническая поддержка проекта, помощь в подборе аналогов, поставка прототипов;
- Система менеджмента качества сертифицирована по Международному стандарту ISO 9001;
- Лицензия ФСБ на осуществление работ с использованием сведений, составляющих государственную тайну;
- Поставка специализированных компонентов (Xilinx, Altera, Analog Devices, Intersil, Interpoint, Microsemi, Aeroflex, Peregrine, Syfer, Eurofarad, Texas Instrument, Miteq, Cobham, E2V, MA-COM, Hittite, Mini-Circuits, General Dynamics и др.);

Помимо этого, одним из направлений компании «ЭлектроПласт» является направление «Источники питания». Мы предлагаем Вам помощь Конструкторского отдела:

- Подбор оптимального решения, техническое обоснование при выборе компонента;
- Подбор аналогов;
- Консультации по применению компонента;
- Поставка образцов и прототипов;
- Техническая поддержка проекта;
- Защита от снятия компонента с производства.



#### Как с нами связаться

**Телефон:** 8 (812) 309 58 32 (многоканальный)

**Факс:** 8 (812) 320-02-42

**Электронная почта:** [org@eplast1.ru](mailto:org@eplast1.ru)

**Адрес:** 198099, г. Санкт-Петербург, ул. Калинина, дом 2, корпус 4, литера А.