

Description

The 74LVCE1G04 is a single inverter gate with a standard totem pole output. The device is designed for operation with a power supply range of 1.4V to 5.5V. The inputs are tolerant to 5.5V allowing this device to be used in a mixed voltage environment. The device is fully specified for partial power down applications using I_{OFF}. The I_{OFF} circuitry disables the output preventing damaging current backflow when the device is powered down.

The gate performs the positive Boolean function:

$$Y = \bar{A}$$

Features

- Extended Supply Voltage Range from 1.4 to 5.5V
- Switching speed characterized for operation at 1.5V
- Offers 30% speed improvement over LVC at 1.8V.
- ± 24mA Output Drive at 3.3V
- CMOS low power consumption
- IOFF Supports Partial-Power-Down Mode Operation
- Input accepts up to 5.5V
- ESD Protection Tested per JESD 22
Exceeds 200-V Machine Model (A115-A)
Exceeds 2000-V Human Body Model (A114-A)
- Latch-Up Exceeds 100mA per JESD 78, Class II
- Range of Package Options
- Direct Interface with TTL Levels
- SOT25, SOT353, and DFN1410: Assembled with "Green" Molding Compound (no Br, Sb)
- Lead Free Finish/ RoHS Compliant (Note 1)

- Notes: 1. EU Directive 2002/95/EC (RoHS). All applicable RoHS exemptions applied. Please visit our website at http://www.diodes.com/products/lead_free.html.
2. Pin 2 and pin 5 of the DFN1410 package are internally connected.

Pin Assignments

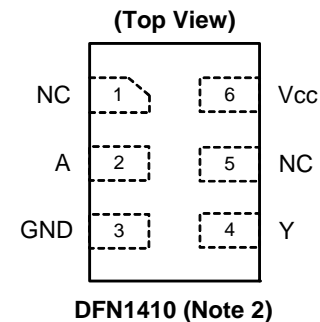
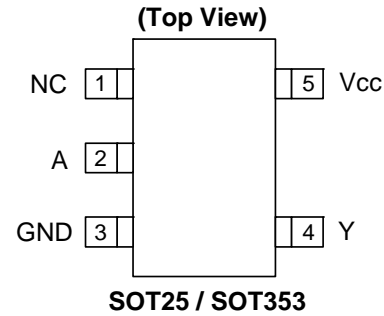

Applications

- Voltage Level Shifting
- General Purpose Logic
- Wide array of products such as.
 - PCs, networking, notebooks, netbooks, PDAs
 - Computer peripherals, hard drives, CD/DVD ROM
 - TV, DVD, DVR, set top box
 - Cell Phones, Personal Navigation / GPS
 - MP3 players ,Cameras, Video Recorders

Pin Descriptions

| Pin Name | Description |
|----------|----------------|
| NC | No connection |
| A | Data Input |
| GND | Ground |
| Y | Data Output |
| Vcc | Supply Voltage |

Logic Diagram

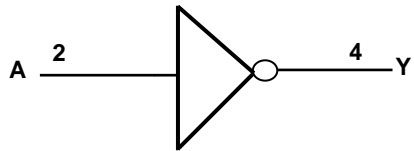

Function Table

| Inputs | Output |
|--------|--------|
| A | Y |
| H | L |
| L | H |

Absolute Maximum Ratings (Note 3)

| Symbol | Description | Rating | Unit |
|-----------|--|------------------------|-------------|
| ESD HBM | Human Body Model ESD Protection | 2 | KV |
| ESD MM | Machine Model ESD Protection | 200 | V |
| V_{CC} | Supply Voltage Range | -0.5 to 6.5 | V |
| V_I | Input Voltage Range | -0.5 to 6.5 | V |
| V_o | Voltage applied to output in high impedance or I_{OFF} state | -0.5 to 6.5 | V |
| V_o | Voltage applied to output in high or low state | -0.3 to $V_{CC} + 0.5$ | V |
| I_{IK} | Input Clamp Current $V_I < 0$ | -50 | mA |
| I_{OK} | Output Clamp Current | -50 | mA |
| I_o | Continuous output current | ± 50 | mA |
| | Continuous current through Vdd or GND | ± 100 | mA |
| T_J | Operating Junction Temperature | -40 to 150 | $^{\circ}C$ |
| T_{STG} | Storage Temperature | -65 to 150 | $^{\circ}C$ |

Note: 3. Stresses beyond the absolute maximum may result in immediate failure or reduced reliability. These are stress values and device operation should be within recommend values.

Recommended Operating Conditions (Note 4)

| Symbol | Parameter | Min | Max | Unit | |
|-----------------|------------------------------------|-----------------------------------|------------------------|------------------------|------|
| V _{CC} | Operating Voltage | Operating | 1.4 | 5.5 | V |
| | | Data retention only | 1.2 | | V |
| V _{IH} | High-level Input Voltage | V _{CC} = 1.4 V to 1.95 V | 0.65 X V _{CC} | | V |
| | | V _{CC} = 2.3 V to 2.7 V | 1.7 | | |
| | | V _{CC} = 3 V to 3.6 V | 2 | | |
| | | V _{CC} = 4.5 V to 5.5 V | 0.7 X V _{CC} | | |
| V _{IL} | Low-level input voltage | V _{CC} = 1.4 V to 1.95 V | | 0.35 X V _{CC} | V |
| | | V _{CC} = 2.3 V to 2.7 V | | 0.7 | |
| | | V _{CC} = 3 V to 3.6 V | | 0.8 | |
| | | V _{CC} = 4.5 V to 5.5 V | | 0.3 X V _{CC} | |
| V _I | Input Voltage | 0 | 5.5 | V | |
| V _O | Output Voltage | 0 | V _{CC} | V | |
| I _{OH} | High-level output current | V _{CC} =1.4 V | | -3 | mA |
| | | V _{CC} = 1.65 V | | -4 | |
| | | V _{CC} = 2.3 V | | -8 | |
| | | V _{CC} = 3 V | | -16 | |
| | | V _{CC} = 4.5 V | | -24 | |
| I _{OL} | Low-level output current | V _{CC} =1.4 V | | 3 | mA |
| | | V _{CC} = 1.65 V | | 4 | |
| | | V _{CC} = 2.3 V | | 8 | |
| | | V _{CC} = 3 V | | 16 | |
| | | V _{CC} = 4.5 V | | 24 | |
| Δt/ΔV | Input transition rise or fall rate | V _{CC} = 1.4 to 3V | | 20 | ns/V |
| | | V _{CC} = 3.3 V ± 0.3 V | | 10 | |
| | | V _{CC} = 5 V ± 0.5 V | | 5 | |
| T _A | Operating free-air temperature | -40 | 85 | °C | |

Note: 4. Unused inputs should be held at V_{CC} or Ground.

Electrical Characteristics (All typical values are at $V_{CC} = 3.3V$, $T_A = 25^\circ C$)

Over recommended free-air temperature range (unless otherwise noted)

| Symbol | Parameter | Test Conditions | Vcc | Min | Typ. | Max | Unit |
|---------------|--|----------------------------------|---------------|----------------|------|----------|--------------|
| V_{OH} | High Level Output Voltage | $I_{OH} = -100\mu A$ | 1.4 V to 5.5V | $V_{CC} - 0.1$ | | | V |
| | | $I_{OH} = -3mA$ | 1.4 V | 1.05 | | | |
| | | $I_{OH} = -4mA$ | 1.65 V | 1.2 | | | |
| | | $I_{OH} = -8mA$ | 2.3V | 1.9 | | | |
| | | $I_{OH} = -16mA$ | 3 V | 2.4 | | | |
| | | $I_{OH} = -24mA$ | | 2.3 | | | |
| | | $I_{OH} = -32mA$ | 4.5 V | 3.8 | | | |
| V_{OL} | High-level Input Voltage | $I_{OL} = 100\mu A$ | 1.4 V to 5.5V | | | 0.1 | V |
| | | $I_{OL} = 3mA$ | 1.4V | | | .4 | |
| | | $I_{OL} = 4mA$ | 1.65 V | | | 0.45 | |
| | | $I_{OL} = 8mA$ | 2.3V | | | 0.3 | |
| | | $I_{OL} = 16mA$ | 3 V | | | 0.4 | |
| | | $I_{OL} = 24mA$ | | | | 0.55 | |
| | | $I_{OL} = 32mA$ | 4.5 | | | 0.55 | |
| I_I | Input Current | $V_I = 5.5 V$ or GND | 0 to 5.5 V | | | ± 5 | μA |
| I_{OFF} | Power Down Leakage Current | V_I or $V_O = 5.5V$ | 0 | | | ± 10 | μA |
| I_{CC} | Supply Current | $V_I = 5.5V$ of GND $I_O = 0$ | 1.4 V to 5.5V | | | 10 | μA |
| C_i | Input Capacitance | $V_i = V_{CC} -$ or GND | 3.3 | | 3.5 | | pF |
| θ_{JA} | Thermal Resistance Junction-to-Ambient | SOT25 | (Note 5) | | 204 | | $^\circ C/W$ |
| | | SOT353 | (Note 5) | | 371 | | |
| | | DFN1410 | (Note 5) | | 430 | | |
| θ_{JC} | Thermal Resistance Junction-to-Case | SOT25 | (Note 5) | | 52 | | $^\circ C/W$ |
| | | SOT353 | (Note 5) | | 143 | | |
| | | DFN1410 | (Note 5) | | 190 | | |

Note: 5. Test condition for SOT25, SOT353, and DFN1410: Device mounted on FR-4 substrate PC board, 2oz copper, with minimum recommended pad layout.

Switching Characteristics

Over recommended free-air temperature range, CL = 15pF (see Figure 1)

| Parameter | From (Input) | TO (OUTPUT) | Vcc = 1.5 V ± 0.1V | | Vcc = 1.8 V ± 0.15V | | Vcc = 2.5 V ± 0.2V | | Vcc = 3.3 V ± 0.3V | | Vcc = 5 V ± 0.5V | | Unit |
|-----------------|--------------|-------------|--------------------|-----|---------------------|-----|--------------------|-----|--------------------|-----|------------------|-----|------|
| | | | Min | Max | Min | Max | Min | Max | Min | Max | Min | Max | |
| t _{pd} | A | Y | 2 | 6.4 | 1.4 | 4.4 | 0.8 | 3.3 | 0.5 | 2.7 | 0.5 | 2.7 | ns |

Over recommended free-air temperature range, CL = 30 or 50pF as noted (see Figure 2)

| Parameter | From (Input) | TO (OUTPUT) | Vcc = 1.5 V ± 0.1V | | Vcc = 1.8 V ± 0.15V | | Vcc = 2.5 V ± 0.2V | | Vcc = 3.3 V ± 0.3V | | Vcc = 5 V ± 0.5V | | Unit |
|-----------------|--------------|-------------|--------------------|-----|---------------------|-----|--------------------|-----|--------------------|-----|------------------|-----|------|
| | | | Min | Max | Min | Max | Min | Max | Min | Max | Min | Max | |
| t _{pd} | A | Y | 3 | 7.5 | 2.1 | 5.2 | 1.1 | 4.1 | 0.8 | 3.4 | 0.9 | 3.3 | ns |

Operating Characteristics

T_A = 25 °C

| Parameter | | Test Conditions | Vcc = 1.5 V | Vcc = 1.8 V | Vcc = 2.5 V | Vcc = 3.3 V | Vcc = 5 V | Unit |
|-----------------|-------------------------------|-----------------|-------------|-------------|-------------|-------------|-----------|------|
| | | | TYP | TYP | TYP | TYP | TYP | |
| C _{pd} | Power dissipation capacitance | f = 10 MHz | 16 | 16 | 18 | 18 | 20 | pF |

Parameter Measurement Information

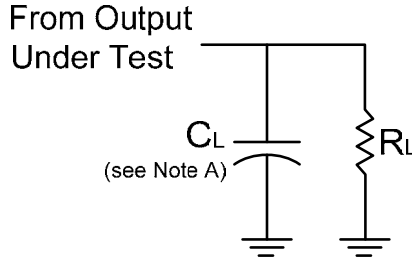

| V _{CC} | Inputs | | V _M | C _L | R _L |
|-----------------|-----------------|--------------------------------|--------------------|----------------|----------------|
| | V _I | t _r /t _f | | | |
| 1.5V±0.1V | V _{CC} | ≤2ns | V _{CC} /2 | 15pF | 1MΩ |
| 1.8V±0.15V | V _{CC} | ≤2ns | V _{CC} /2 | 15pF | 1MΩ |
| 2.5V±0.2V | V _{CC} | ≤2ns | V _{CC} /2 | 15pF | 1MΩ |
| 3.3V±0.3V | 3V | ≤2.5ns | 1.5V | 15pF | 1MΩ |
| 5V±0.5V | V _{CC} | ≤2.5ns | V _{CC} /2 | 15pF | 1MΩ |

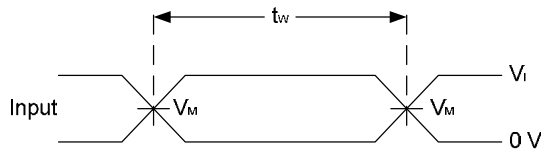

**Voltage Waveform
Pulse Duration**

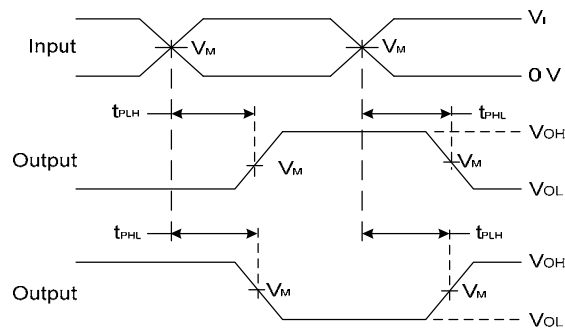

**Voltage Waveform
Propagation Delay Times
Inverting and Non Inverting Outputs**

- Notes:
- A. Includes test lead and test apparatus capacitance.
 - B. All pulses are supplied at pulse repetition rate ≤ 10 MHz.
 - C. Inputs are measured separately one transition per measurement.
 - D. t_{PLH} and t_{PHL} are the same as t_{PD}.

Figure 1. Load Circuit and Voltage Waveforms

Parameter Measurement Information (Continued)

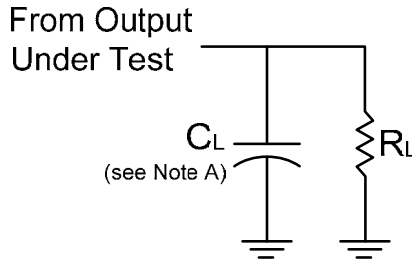

| V_{CC} | Inputs | | V_M | C_L | R_L |
|------------------|----------|--------------|------------|-------|--------------|
| | V_I | t_r/t_f | | | |
| $1.5V \pm 0.1V$ | V_{CC} | $\leq 2ns$ | $V_{CC}/2$ | 30pF | 1K Ω |
| $1.8V \pm 0.15V$ | V_{CC} | $\leq 2ns$ | $V_{CC}/2$ | 30pF | 1K Ω |
| $2.5V \pm 0.2V$ | V_{CC} | $\leq 2ns$ | $V_{CC}/2$ | 30pF | 500 Ω |
| $3.3V \pm 0.3V$ | 3V | $\leq 2.5ns$ | 1.5V | 50pF | 500 Ω |
| $5V \pm 0.5V$ | V_{CC} | $\leq 2.5ns$ | $V_{CC}/2$ | 50pF | 500 Ω |

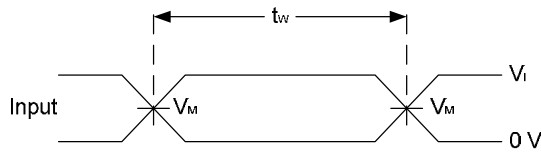

**Voltage Waveform
Pulse Duration**



**Voltage Waveform
Propagation Delay Times
Inverting and Non Inverting Outputs**

- Notes: A. Includes test lead and test apparatus capacitance.
 B. All pulses are supplied at pulse repetition rate ≤ 10 MHz.
 C. Inputs are measured separately one transition per measurement.
 D. t_{PLH} and t_{PHL} are the same as t_{PD} .

Figure 2. Load Circuit and Voltage Waveforms

Ordering Information

74LVCE1G 04 XXX - 7

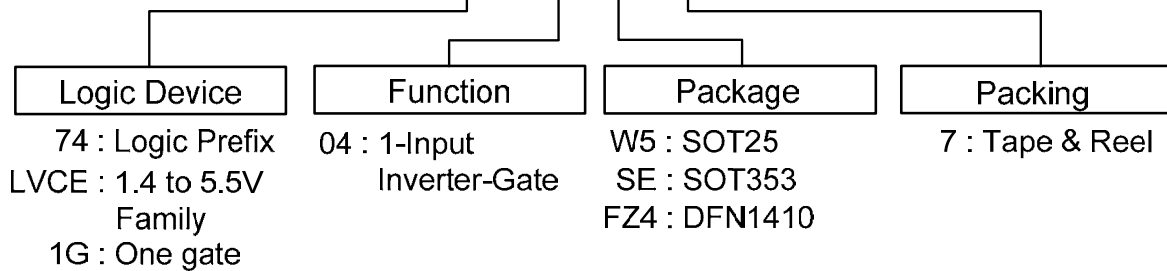

| Device | Package Code | Packaging (Note 5) | 7" Tape and Reel | |
|-----------------|--------------|--------------------|------------------|--------------------|
| | | | Quantity | Part Number Suffix |
| 74LVCE1G04W5-7 | W6 | SOT25 | 3000/Tape & Reel | -7 |
| 74LVCE1G04SE-7 | SE | SOT353 | 3000/Tape & Reel | -7 |
| 74LVCE1G04FZ4-7 | FZ4 | DFN1410 | 5000/Tape & Reel | -7 |



Note: 6. Pad layout as shown on Diodes Inc. suggested pad layout document AP02001, which can be found on our website at <http://www.diodes.com/datasheets/ap02001.pdf>.

NEW PRODUCT

Marking Information

(1) SOT25 and SOT353

(Top View)

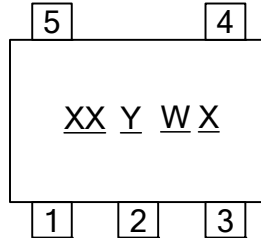

XX : Identification code
Y : Year 0~9
W : Week : A~Z : 1~26 week;
a~z : 27~52 week; z represents
52 and 53 week
X : A~Z : Internal code

| Part Number | Package | Identification Code |
|--------------|---------|---------------------|
| 74LVCE1G04W5 | SOT25 | PU |
| 74LVCE1G04SE | SOT353 | PV |

(2) DFN1410H4-6

(Top View)

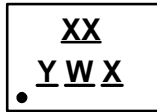

XX : Identification Code
Y : Year : 0~9
W : Week : A~Z : 1~26 week;
a~z : 27~52 week; z represents
52 and 53 week
X : A~Z : Internal code

| Part Number | Package | Identification Code |
|---------------|---------|---------------------|
| 74LVCE1G04FZ4 | DFN1410 | PU |

Package Outline Dimensions (All Dimensions in mm)

(1) Package Type: SOT25



(2) Package Type: SOT353



Package Outline Dimensions (All Dimensions in mm)

(3) Package Type: DFN1410

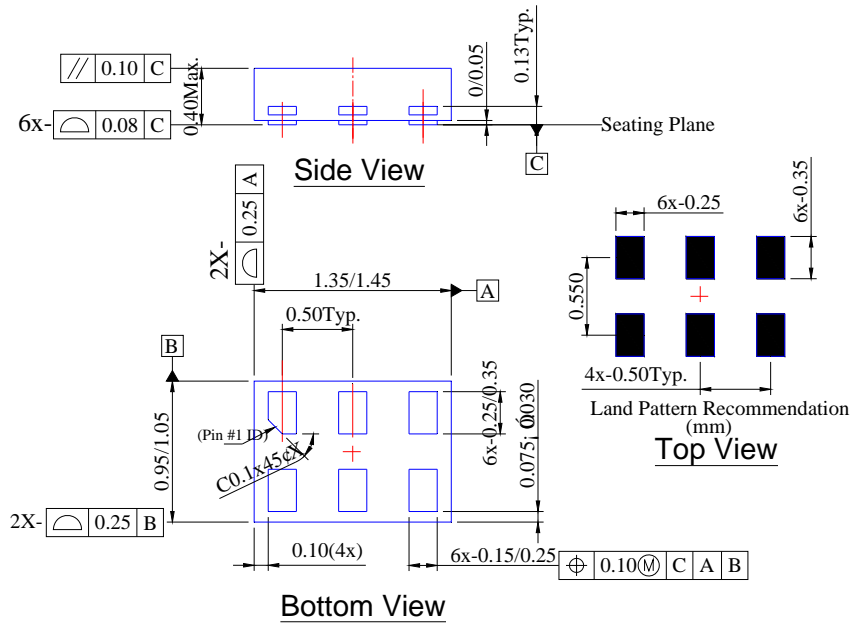

NEW PRODUCT

Taping Orientation (Note 7)

For DFN1410

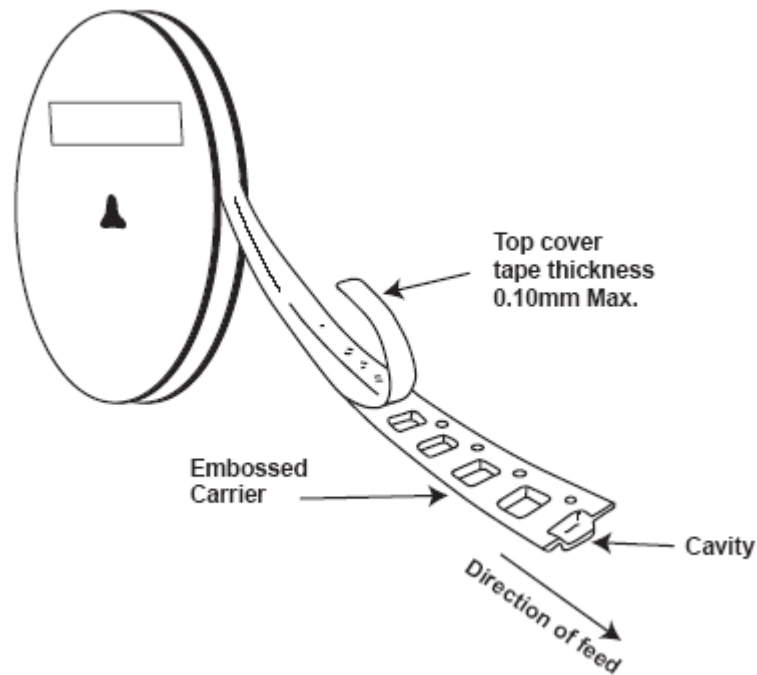
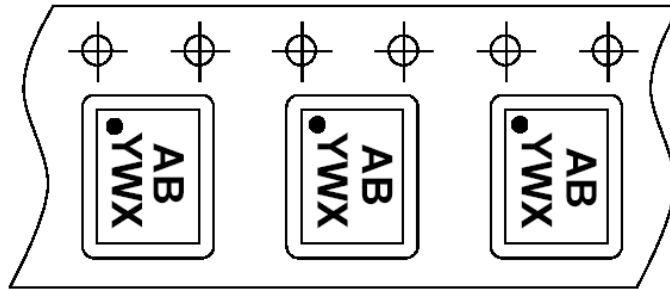

Note: 7. The taping orientation of the other package type can be found on our website at <http://www.diodes.com/datasheets/ap02007.pdf>

NEW PRODUCT

IMPORTANT NOTICE

DIODES INCORPORATED MAKES NO WARRANTY OF ANY KIND, EXPRESS OR IMPLIED, WITH REGARDS TO THIS DOCUMENT, INCLUDING, BUT NOT LIMITED TO, THE IMPLIED WARRANTIES OF MERCHANTABILITY AND FITNESS FOR A PARTICULAR PURPOSE (AND THEIR EQUIVALENTS UNDER THE LAWS OF ANY JURISDICTION).

Diodes Incorporated and its subsidiaries reserve the right to make modifications, enhancements, improvements, corrections or other changes without further notice to this document and any product described herein. Diodes Incorporated does not assume any liability arising out of the application or use of this document or any product described herein; neither does Diodes Incorporated convey any license under its patent or trademark rights, nor the rights of others. Any Customer or user of this document or products described herein in such applications shall assume all risks of such use and will agree to hold Diodes Incorporated and all the companies whose products are represented on Diodes Incorporated website, harmless against all damages.

Diodes Incorporated does not warrant or accept any liability whatsoever in respect of any products purchased through unauthorized sales channel.

Should Customers purchase or use Diodes Incorporated products for any unintended or unauthorized application, Customers shall indemnify and hold Diodes Incorporated and its representatives harmless against all claims, damages, expenses, and attorney fees arising out of, directly or indirectly, any claim of personal injury or death associated with such unintended or unauthorized application.

Products described herein may be covered by one or more United States, international or foreign patents pending. Product names and markings noted herein may also be covered by one or more United States, international or foreign trademarks.

LIFE SUPPORT

Diodes Incorporated products are specifically not authorized for use as critical components in life support devices or systems without the express written approval of the Chief Executive Officer of Diodes Incorporated. As used herein:

A. Life support devices or systems are devices or systems which:

1. are intended to implant into the body, or
2. support or sustain life and whose failure to perform when properly used in accordance with instructions for use provided in the labeling can be reasonably expected to result in significant injury to the user.

B. A critical component is any component in a life support device or system whose failure to perform can be reasonably expected to cause the failure of the life support device or to affect its safety or effectiveness.

Customers represent that they have all necessary expertise in the safety and regulatory ramifications of their life support devices or systems, and acknowledge and agree that they are solely responsible for all legal, regulatory and safety-related requirements concerning their products and any use of Diodes Incorporated products in such safety-critical, life support devices or systems, notwithstanding any devices- or systems-related information or support that may be provided by Diodes Incorporated. Further, Customers must fully indemnify Diodes Incorporated and its representatives against any damages arising out of the use of Diodes Incorporated products in such safety-critical, life support devices or systems.

Copyright © 2010, Diodes Incorporated

www.diodes.com



Компания «ЭлектроПласт» предлагает заключение долгосрочных отношений при поставках импортных электронных компонентов на взаимовыгодных условиях!

Наши преимущества:

- Оперативные поставки широкого спектра электронных компонентов отечественного и импортного производства напрямую от производителей и с крупнейших мировых складов;
- Поставка более 17-ти миллионов наименований электронных компонентов;
- Поставка сложных, дефицитных, либо снятых с производства позиций;
- Оперативные сроки поставки под заказ (от 5 рабочих дней);
- Экспресс доставка в любую точку России;
- Техническая поддержка проекта, помощь в подборе аналогов, поставка прототипов;
- Система менеджмента качества сертифицирована по Международному стандарту ISO 9001;
- Лицензия ФСБ на осуществление работ с использованием сведений, составляющих государственную тайну;
- Поставка специализированных компонентов (Xilinx, Altera, Analog Devices, Intersil, Interpoint, Microsemi, Aeroflex, Peregrine, Syfer, Eurofarad, Texas Instrument, Miteq, Cobham, E2V, MA-COM, Hittite, Mini-Circuits, General Dynamics и др.);

Помимо этого, одним из направлений компании «ЭлектроПласт» является направление «Источники питания». Мы предлагаем Вам помощь Конструкторского отдела:

- Подбор оптимального решения, техническое обоснование при выборе компонента;
- Подбор аналогов;
- Консультации по применению компонента;
- Поставка образцов и прототипов;
- Техническая поддержка проекта;
- Защита от снятия компонента с производства.



Как с нами связаться

Телефон: 8 (812) 309 58 32 (многоканальный)

Факс: 8 (812) 320-02-42

Электронная почта: org@eplast1.ru

Адрес: 198099, г. Санкт-Петербург, ул. Калинина, дом 2, корпус 4, литера А.