



## Inductors

RF chokes, LBC+ series

**Series/Type:**            **B82144B2**

**Date:**                    April 2015

© EPCOS AG 2015. Reproduction, publication and dissemination of this publication, enclosures hereto and the information contained therein without EPCOS' prior express consent is prohibited.

EPCOS AG is a TDK Group Company.

## Inductors

### RF chokes, LBC+ series

B82144B2

#### LBC chokes, radial leaded

Rated inductance 1  $\mu\text{H}$  ... 470  $\mu\text{H}$

Rated current 600 mA ... 4450 mA

#### Construction

- Large ferrite drum core
- Winding: enamel copper wire
- Flame-retardant lacquer coating
- Non-lacquered lead wire

#### Features

- Very high rated current
- High saturation behaviour
- Suitable for wave soldering
- RoHS-compatible

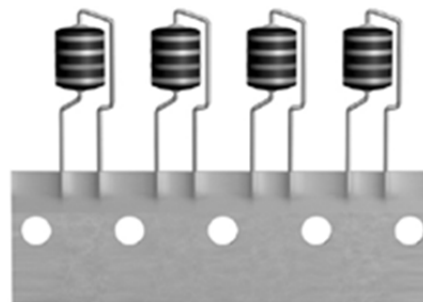

#### Applications

- DC-DC converters
- Filtering of supply voltage
- RF blocking and filtering
- Decoupling and interference suppression
- For telecommunications, LED and energy-saving lamps, entertainment electronics

#### Terminals

- Radially bent to 5 mm lead spacing
- Base material CuAg0.1
- Electroplated with nickel and pure tin

#### Marking

- Inductance indicated by color bands in accordance with IEC 60062

#### Delivery mode and packing units

- Taped, reel packing
- Packing unit: 1000 pcs/reel

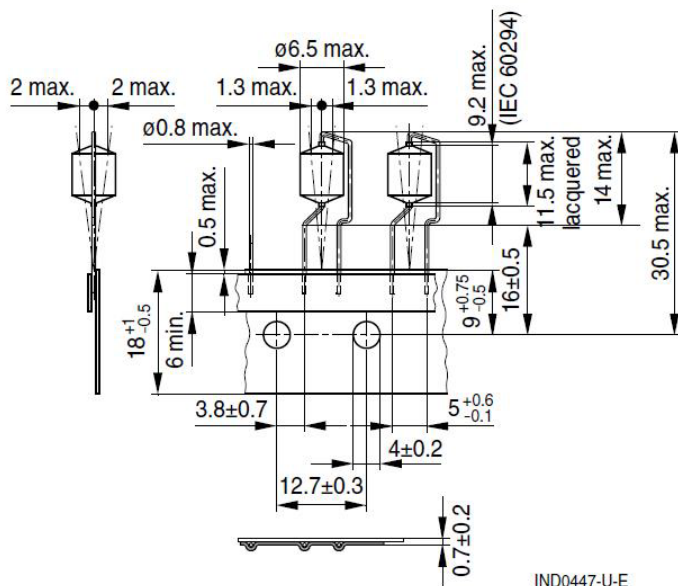
**Dimensional drawing**

Dimensions in mm

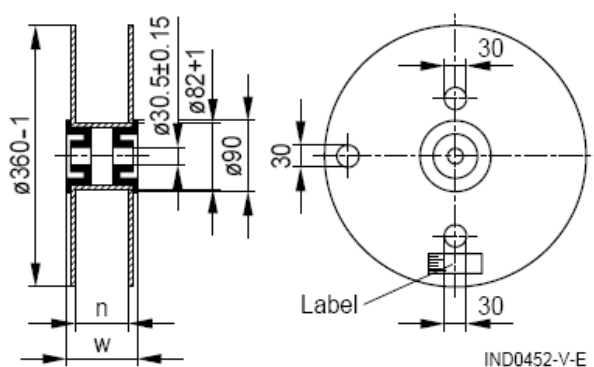
**Packing**

Dimensions in mm

n (mm): 72 +1  
w (mm): 84 max

**Inductors**
**RF chokes, LBC+ series**
**B82144B2**
**Technical data and measuring conditions**

Rated inductance $L_R$	Measured with LCR meter Agilent 4284A or impedance analyzer Agilent 4294A Measuring frequency: $L_R \leq 10 \mu\text{H}$ = 1 MHz $10 \mu\text{H} < L_R \leq 470\mu\text{H}$ = 100 kHz Measuring current: 1 mA Measuring temperature: +20 °C
Q factor $Q_{\min}$	Measured with impedance analyzer Agilent 4294A, +20 °C
Rated temperature $T_R$	+40 °C
Rated current $I_R$	Maximum permissible DC current based on rated temperature of +40 °C and component temperature of max. +125 °C
Saturation current $I_{\text{sat}}$	Max. permissible DC with inductance decrease $\Delta L/L_0$ of approx. 10%, at +20 °C
DC resistance $R_{\text{max}}$	Measured at +20 °C
Resonance frequency $f_{\text{res,min}}$	Measured with Agilent 4294A or 8753ES, +20 °C
Solderability (lead-free)	Sn95.5Ag3.8Cu0.7: (+245 ±5) °C, (3 ±0.3) s Wetting of soldering area: ≥ 90% (to IEC 60068-2-20, test Ta)
Resistance to soldering heat	(+260 ±5)°C, 10 s (to IEC 60068-2-20, test Tb)
Tensile strength of leads	≥ 20 N (to IEC 60068-2-21, test Ua)
Climatic category	55/125/56 (to IEC 60068-1)
Storage conditions	Mounted: -55 °C ... +125 °C Packaged: -25 °C ... +40 °C, ≤ 75% RH
Weight	Approx. 0.95 g

**Mounting information:**

When bending the leads, take care that the start-of-winding areas at the face ends (protected by glue and lacquer) are not subjected to any mechanical stress.

**Inductors**
**RF chokes, LBC+ series**
**B82144B2**
**Characteristics and ordering codes**

$L_R$ $\mu\text{H}$	Tolerance	$Q_{\min}$	$f_Q$ MHz	$I_R$ mA	$I_{\text{sat}}$ mA	$R_{\max}$ $\Omega$	$f_{\text{res, min}}$ MHz	Ordering code
1.0	$\pm 10\% \cong K$	50	2.52	4450	7700	0.043	200	B82144B2102K000
1.2		60	2.52	4250	7400	0.044	190	B82144B2122K000
1.5		60	2.52	4100	7200	0.045	170	B82144B2152K000
1.8		60	2.52	3750	6400	0.050	150	B82144B2182K000
2.2		60	2.52	3650	6000	0.055	140	B82144B2222K000
2.7		60	2.52	3550	5400	0.060	120	B82144B2272K000
3.3		60	2.52	3500	5000	0.065	100	B82144B2332K000
3.9		60	2.52	3350	4400	0.075	90	B82144B2392K000
4.7		50	2.52	3050	4000	0.080	70	B82144B2472K000
5.6		50	2.52	2950	3750	0.090	45	B82144B2562K000
6.8		50	2.52	2750	3500	0.095	40	B82144B2682K000
8.2		40	0.252	2650	3100	0.105	28	B82144B2822K000
10		40	0.252	2450	2850	0.120	22	B82144B2103K000
12		40	0.252	2400	2650	0.130	20	B82144B2123K000
15		50	0.252	2300	2400	0.140	13	B82144B2153K000
18	50	0.252	2200	2250	0.155	12	B82144B2183K000	
22	50	0.252	2100	2000	0.175	10	B82144B2223K000	
27	40	0.252	2000	1800	0.200	9.2	B82144B2273K000	
33	$\pm 5\% \cong J$	40	0.252	1900	1650	0.220	9.0	B82144B2333J000
39		40	0.252	1750	1500	0.250	8.5	B82144B2393J000
47		40	0.252	1700	1400	0.270	7.5	B82144B2473J000
56		40	0.0796	1600	1300	0.310	6.8	B82144B2563J000
68		40	0.0796	1500	1150	0.350	6.1	B82144B2683J000
82		40	0.0796	1400	1100	0.400	6.0	B82144B2823J000
100		40	0.0796	1300	950	0.460	5.4	B82144B2104J000

**Inductors**
**RF chokes, LBC+ series**
**B82144B2**

$L_R$ $\mu\text{H}$	Tolerance	$Q_{\min}$	$f_Q$ MHz	$I_R$ mA	$I_{\text{sat}}$ mA	$R_{\text{max}}$ $\Omega$	$f_{\text{res, min}}$ MHz	Ordering code
120	$\pm 5\% \hat{=} J$	40	0.0796	1100	850	0.600	4.6	B82144B2124J000
150		40	0.0796	1050	750	0.700	4.2	B82144B2154J000
180		40	0.0796	950	720	0.785	4.0	B82144B2184J000
220		40	0.0796	900	650	1.010	3.6	B82144B2224J000
270		40	0.0796	800	580	1.200	3.2	B82144B2274J000
330		40	0.0796	700	520	1.530	2.8	B82144B2334J000
390		40	0.0796	650	480	1.720	2.5	B82144B2394J000
470		40	0.0796	600	440	2.020	2.3	B82144B2474J000

## Inductors

### RF chokes, LBC+ series

B82144B2

#### Impedance $|Z|$ versus frequency $f$

measured with impedance analyzer Agilent 4294A or S-parameter network analyzer Agilent 8753ES, typical values at +20°C

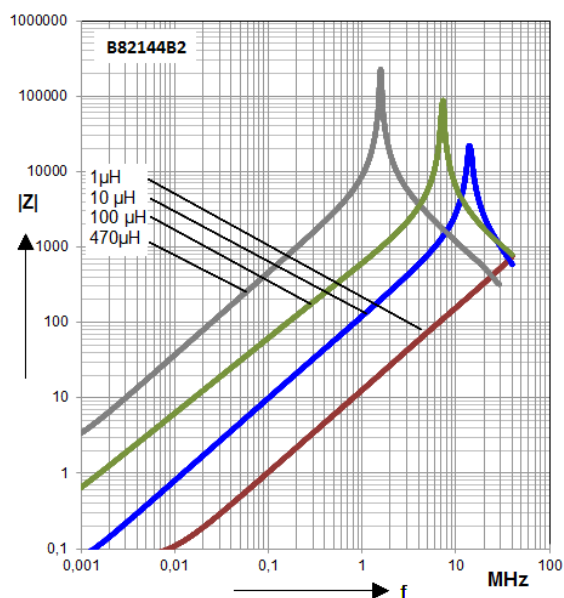

#### Inductance $L$ versus DC load current $I_{DC}$

measured with LCR meter Agilent 4284A, typical values at +20°C

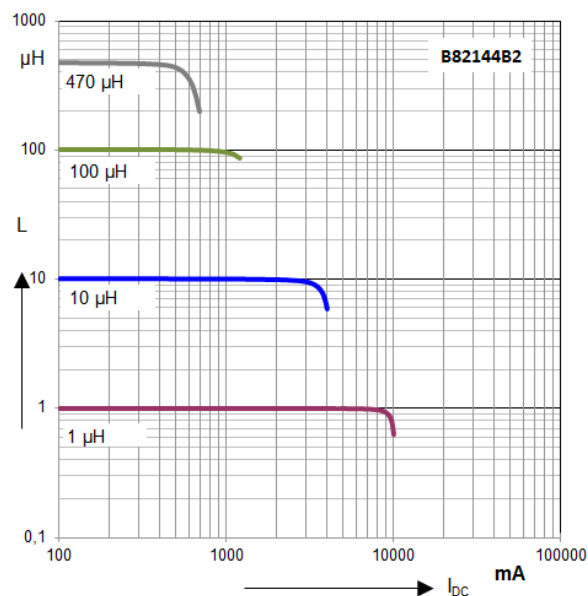

#### Q factor versus frequency $f$

measured with impedance analyzer Agilent 4294A, typical values at +20°C

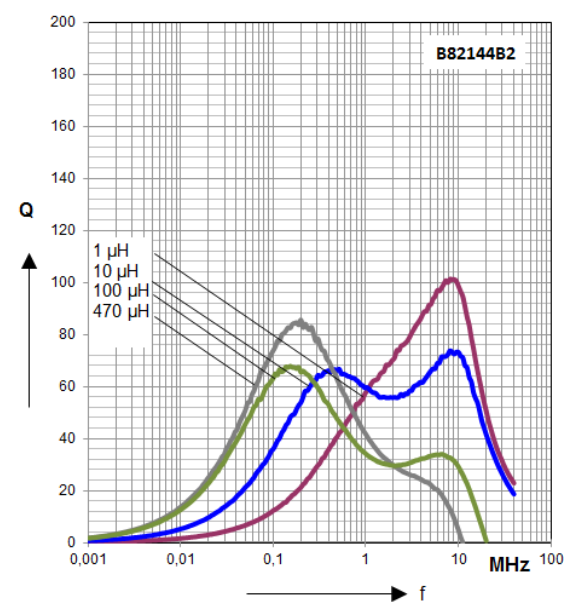

#### Current derating $I_{OP}/I_R$ versus ambient temperature $T_A$

(rated temperature  $T_R = +40^\circ\text{C}$ )

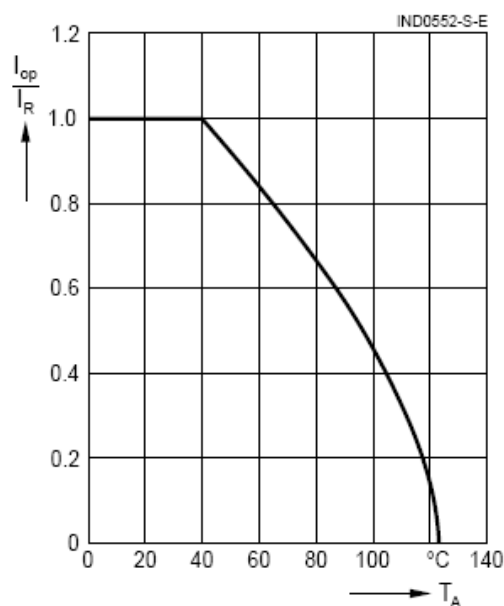

### Cautions and warnings

- Please note the recommendations in our Inductors data book (latest edition) and in the data sheets.
  - Particular attention should be paid to the derating curves given there.
  - The soldering conditions should also be observed. Temperatures quoted in relation to wave soldering refer to the pin, not the housing.
- If the components are to be washed varnished it is necessary to check whether the washing varnish agent that is used has a negative effect on the wire insulation, any plastics that are used, or on glued joints. In particular, it is possible for washing varnish agent residues to have a negative effect in the long-term on wire insulation. Washing processes may damage the product due to the possible static or cyclic mechanical loads (e.g. ultrasonic cleaning). They may cause cracks to develop on the product and its parts, which might lead to reduced reliability or lifetime.
- The following points must be observed if the components are potted in customer applications:
  - Many potting materials shrink as they harden. They therefore exert a pressure on the plastic housing or core. This pressure can have a deleterious effect on electrical properties, and in extreme cases can damage the core or plastic housing mechanically.
  - It is necessary to check whether the potting material used attacks or destroys the wire insulation, plastics or glue.
  - The effect of the potting material can change the high-frequency behaviour of the components.
- Ferrites are sensitive to direct impact. This can cause the core material to flake, or lead to breakage of the core.
- Even for customer-specific products, conclusive validation of the component in the circuit can only be carried out by the customer.

### Display of ordering codes for EPCOS products

The ordering code for one and the same product can be represented differently in data sheets, data books, other publications and the website of EPCOS, or in order-related documents such as shipping notes, order confirmations and product labels. **The varying representations of the ordering codes are due to different processes employed and do not affect the specifications of the respective products.** Detailed information can be found on the Internet under [www.epcos.com/orderingcodes](http://www.epcos.com/orderingcodes).



## Important notes

The following applies to all products named in this publication:

1. Some parts of this publication contain **statements about the suitability of our products for certain areas of application**. These statements are based on our knowledge of typical requirements that are often placed on our products in the areas of application concerned. We nevertheless expressly point out **that such statements cannot be regarded as binding statements about the suitability of our products for a particular customer application**. As a rule we are either unfamiliar with individual customer applications or less familiar with them than the customers themselves. For these reasons, it is always ultimately incumbent on the customer to check and decide whether a product with the properties described in the product specification is suitable for use in a particular customer application.
2. We also point out that **in individual cases, a malfunction of electronic components or failure before the end of their usual service life cannot be completely ruled out in the current state of the art, even if they are operated as specified**. In customer applications requiring a very high level of operational safety and especially in customer applications in which the malfunction or failure of an electronic component could endanger human life or health (e.g. in accident prevention or life-saving systems), it must therefore be ensured by means of suitable design of the customer application or other action taken by the customer (e.g. installation of protective circuitry or redundancy) that no injury or damage is sustained by third parties in the event of malfunction or failure of an electronic component.
3. **The warnings, cautions and product-specific notes must be observed.**
4. In order to satisfy certain technical requirements, **some of the products described in this publication may contain substances subject to restrictions in certain jurisdictions (e.g. because they are classed as hazardous)**. Useful information on this will be found in our Material Data Sheets on the Internet ([www.tdk-electronics.tdk.com/material](http://www.tdk-electronics.tdk.com/material)). Should you have any more detailed questions, please contact our sales offices.
5. We constantly strive to improve our products. Consequently, **the products described in this publication may change from time to time**. The same is true of the corresponding product specifications. Please check therefore to what extent product descriptions and specifications contained in this publication are still applicable before or when you place an order.  
  
We also **reserve the right to discontinue production and delivery of products**. Consequently, we cannot guarantee that all products named in this publication will always be available. The aforementioned does not apply in the case of individual agreements deviating from the foregoing for customer-specific products.
6. Unless otherwise agreed in individual contracts, **all orders are subject to our General Terms and Conditions of Supply**.
7. **Our manufacturing sites serving the automotive business apply the IATF 16949 standard**. The IATF certifications confirm our compliance with requirements regarding the quality management system in the automotive industry. Referring to customer requirements and customer specific requirements ("CSR") TDK always has and will continue to have the policy of respecting individual agreements. Even if IATF 16949 may appear to support the acceptance of unilateral requirements, we hereby like to emphasize that **only requirements mutually agreed upon can and will be implemented in our Quality Management System**. For clarification purposes we like to point out that obligations from IATF 16949 shall only become legally binding if individually agreed upon.
8. The trade names EPCOS, CeraCharge, CeraDiode, CeraLink, CeraPad, CeraPlas, CSMP, CTVS, DeltaCap, DigiSiMic, ExoCore, FilterCap, FormFit, LeaXield, MiniBlue, MiniCell, MKD, MKK, MotorCap, PCC, PhaseCap, PhaseCube, PhaseMod, PhiCap, PowerHap, PQSine, PQvar, SIFERRIT, SIFI, SIKOREL, SilverCap, SIMDAD, SiMic, SIMID, SineFormer, SIOV, ThermoFuse, WindCap are **trademarks registered or pending** in Europe and in other countries. Further information will be found on the Internet at [www.tdk-electronics.tdk.com/trademarks](http://www.tdk-electronics.tdk.com/trademarks).

Release 2018-10

# Mouser Electronics

Authorized Distributor

Click to View Pricing, Inventory, Delivery & Lifecycle Information:

## EPCOS / TDK:

[B82144B2394J000](#) [B82144B2333J000](#) [B82144B2392K000](#) [B82144B2183K000](#) [B82144B2224J000](#)  
[B82144B2393J000](#) [B82144B2104J000](#) [B82144B2122K000](#) [B82144B2473J000](#) [B82144B2152K000](#)  
[B82144B2472K000](#) [B82144B2222K000](#) [B82144B2562K000](#) [B82144B2182K000](#) [B82144B2123K000](#)  
[B82144B2103K000](#) [B82144B2682K000](#) [B82144B2184J000](#) [B82144B2153K000](#) [B82144B2223K000](#)  
[B82144B2332K000](#) [B82144B2124J000](#) [B82144B2273K000](#) [B82144B2154J000](#) [B82144B2274J000](#)  
[B82144B2272K000](#) [B82144B2334J000](#) [B82144B2822K000](#) [B82144B2683J000](#) [B82144B2474J000](#)  
[B82144B2102K000](#) [B82144B2563J000](#) [B82144B2823J000](#)



Компания «ЭлектроПласт» предлагает заключение долгосрочных отношений при поставках импортных электронных компонентов на взаимовыгодных условиях!

Наши преимущества:

- Оперативные поставки широкого спектра электронных компонентов отечественного и импортного производства напрямую от производителей и с крупнейших мировых складов;
- Поставка более 17-ти миллионов наименований электронных компонентов;
- Поставка сложных, дефицитных, либо снятых с производства позиций;
- Оперативные сроки поставки под заказ (от 5 рабочих дней);
- Экспресс доставка в любую точку России;
- Техническая поддержка проекта, помощь в подборе аналогов, поставка прототипов;
- Система менеджмента качества сертифицирована по Международному стандарту ISO 9001;
- Лицензия ФСБ на осуществление работ с использованием сведений, составляющих государственную тайну;
- Поставка специализированных компонентов (Xilinx, Altera, Analog Devices, Intersil, Interpoint, Microsemi, Aeroflex, Peregrine, Syfer, Eurofarad, Texas Instrument, Miteq, Cobham, E2V, MA-COM, Hittite, Mini-Circuits, General Dynamics и др.);

Помимо этого, одним из направлений компании «ЭлектроПласт» является направление «Источники питания». Мы предлагаем Вам помощь Конструкторского отдела:

- Подбор оптимального решения, техническое обоснование при выборе компонента;
- Подбор аналогов;
- Консультации по применению компонента;
- Поставка образцов и прототипов;
- Техническая поддержка проекта;
- Защита от снятия компонента с производства.



#### Как с нами связаться

**Телефон:** 8 (812) 309 58 32 (многоканальный)

**Факс:** 8 (812) 320-02-42

**Электронная почта:** [org@eplast1.ru](mailto:org@eplast1.ru)

**Адрес:** 198099, г. Санкт-Петербург, ул. Калинина, дом 2, корпус 4, литера А.