



# BIPOLAR ANALOG INTEGRATED CIRCUIT

# $\mu$ PC8232T5N

## SiGe:C LOW NOISE AMPLIFIER FOR GPS

### DESCRIPTION

The  $\mu$ PC8232T5N is a silicon germanium carbon (SiGe:C) monolithic integrated circuit designed as low noise amplifier for GPS. This device exhibits low noise figure and high power gain characteristics, so this IC can improve the sensitivity of GPS receiver. In addition, the  $\mu$ PC8232T5N which is included output matching circuit contributes to reduce external components and system size.

The package is a 6-pin plastic TSON (Thin Small Out-line Non-leaded) suitable for surface mount.

This IC is manufactured using our UHS4 (Ultra High Speed Process) SiGe:C bipolar process.

### FEATURES

- Low noise : NF = 0.95 dB TYP. @  $f_{in} = 1.575$  MHz
- High gain : GP = 17 dB TYP. @  $f_{in} = 1.575$  MHz
- Low current consumption :  $I_{CC} = 3.0$  mA TYP. @  $V_{CC} = 3.0$  V
- Built-in power-saving function
- High-density surface mounting : 6-pin plastic TSON package (1.5 × 1.5 × 0.37 mm)
- Included output matching circuit
- Included very robust bandgap regulator (Small  $V_{CC}$  and  $T_A$  dependence)
- Included protection circuits for ESD

### APPLICATION

- Low noise amplifier for GPS

### ORDERING INFORMATION

Part Number	Order Number	Package	Marking	Supplying Form
$\mu$ PC8232T5N-E2	$\mu$ PC8232T5N-E2-A	6-pin plastic TSON (Pb-Free)	6L	<ul style="list-style-type: none"><li>• 8 mm wide embossed taping</li><li>• Pin 1, 6 face the perforation side of the tape</li><li>• Qty 3 kpcs/reel</li></ul>

**Remark** To order evaluation samples, contact your nearby sales office.

Part number for sample order:  $\mu$ PC8232T5N-A

**Caution** Observe precautions when handling because these devices are sensitive to electrostatic discharge.

The information in this document is subject to change without notice. Before using this document, please confirm that this is the latest version.

**PIN CONNECTIONS AND INTERNAL BLOCK DIAGRAM**

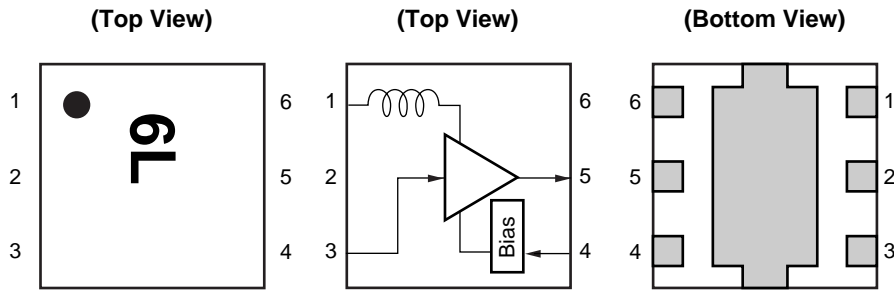

Pin No.	Pin Name
1	V <sub>CC</sub>
2	GND
3	INPUT
4	Power Save
5	OUTPUT
6	V <sub>CC</sub>

**Remark** Exposed pad : GND

**ABSOLUTE MAXIMUM RATINGS**

Parameter	Symbol	Test Conditions	Ratings	Unit
Supply Voltage	V <sub>CC</sub>	T <sub>A</sub> = +25°C	4.0	V
Power-Saving Voltage	V <sub>PS</sub>	T <sub>A</sub> = +25°C	4.0	V
Total Power Dissipation	P <sub>tot</sub>		150	mW
Operating Ambient Temperature	T <sub>A</sub>		-40 to +85	°C
Storage Temperature	T <sub>stg</sub>		-55 to +150	°C
Input Power	P <sub>in</sub>		+10	dBm

**RECOMMENDED OPERATING RANGE**

Parameter	Symbol	MIN.	TYP.	MAX.	Unit
Supply Voltage	V <sub>CC</sub>	2.5	3.0	3.3	V
Operating Ambient Temperature	T <sub>A</sub>	-40	+25	+85	°C
Power Save Turn-on Voltage	V <sub>PSon</sub>	1.6	-	V <sub>CC</sub>	V
Power Save Turn-off Voltage	V <sub>PSoff</sub>	0	-	0.4	V

**ELECTRICAL CHARACTERISTICS**

( $T_A = +25^\circ\text{C}$ ,  $V_{CC} = V_{PS} = 3.0\text{ V}$ ,  $f_{in} = 1\ 575\text{ MHz}$ , unless otherwise specified)

Parameter	Symbol	Test Conditions	MIN.	TYP.	MAX.	Unit
Circuit Current	$I_{CC}$	No Signal ( $V_{PS} = 3.0\text{ V}$ )	2.3	3.0	4.1	mA
		At Power-Saving Mode ( $V_{PS} = 0\text{ V}$ )	–	–	1	$\mu\text{A}$
Power Gain	$G_P$	$P_{in} = -35\text{ dBm}$	15	17	19	dB
Noise Figure	NF		–	0.95	1.25	dB
Input 3rd Order Distortion Intercept Point	IIP <sub>3</sub>	$f_{in1} = 1\ 574\text{ MHz}$ , $f_{in2} = 1\ 575\text{ MHz}$	–	-8	–	dBm
Input Return Loss	$RL_{in}$		7	10	–	dB
Output Return Loss	$RL_{out}$		10	20	–	dB
Isolation	ISL		–	40	–	dB
Gain 1 dB Compression Input Power	$P_{in(1\text{ dB})}$		–	-21	–	dBm

**TEST CIRCUIT**

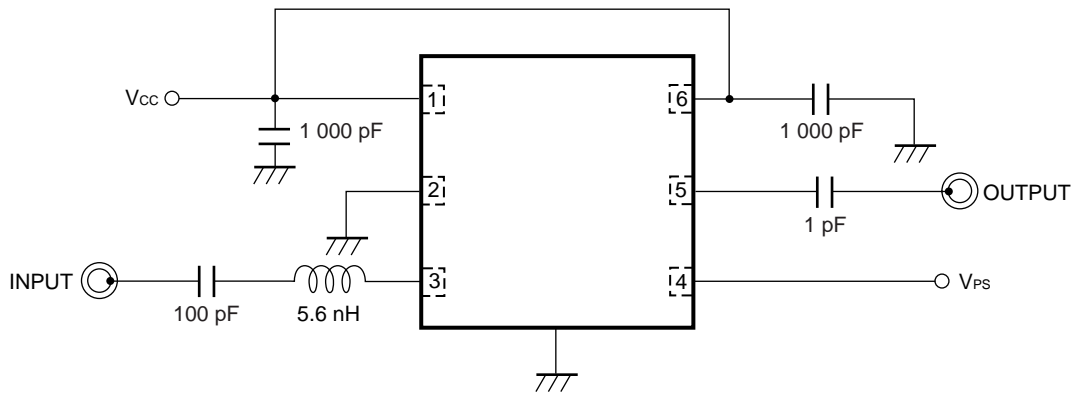

**TYPICAL CHARACTERISTICS ( $T_A = +25^\circ\text{C}$ , unless otherwise specified)**

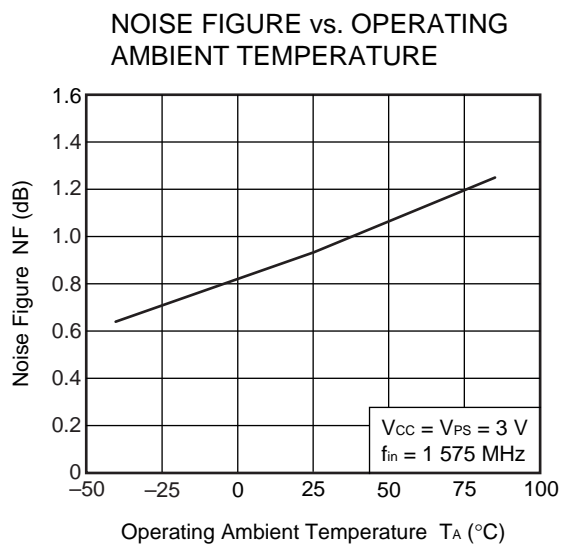
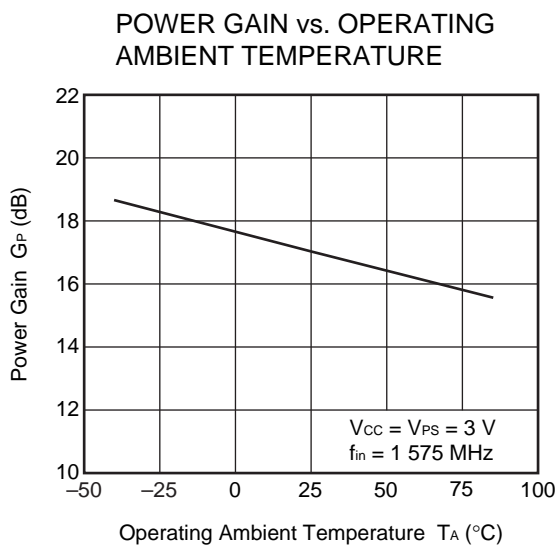
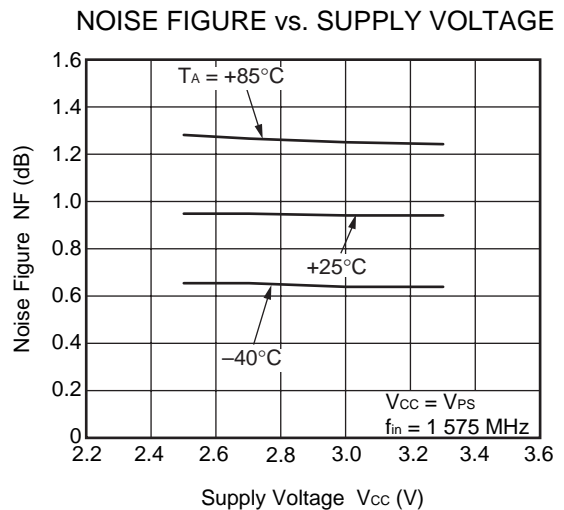
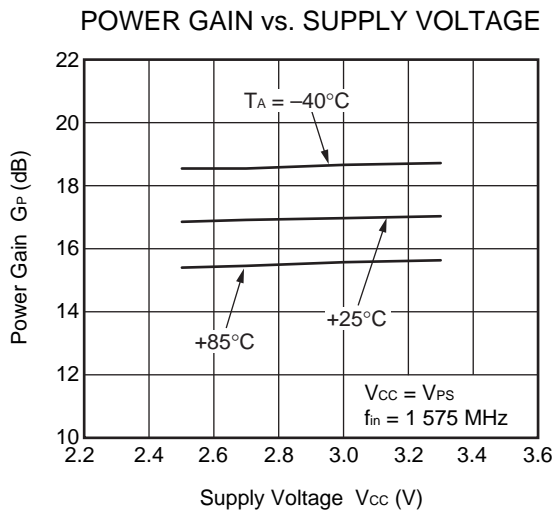
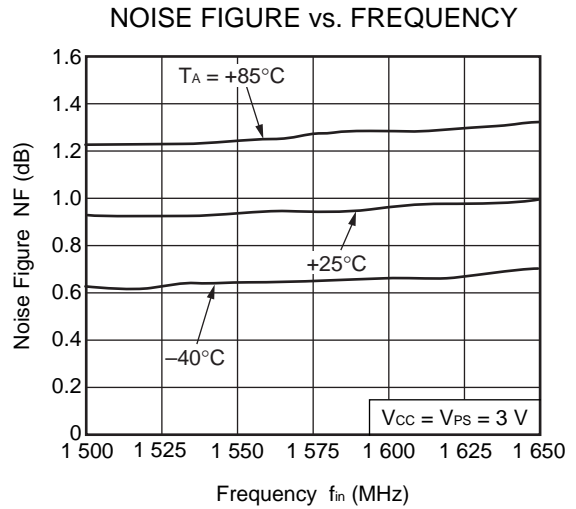
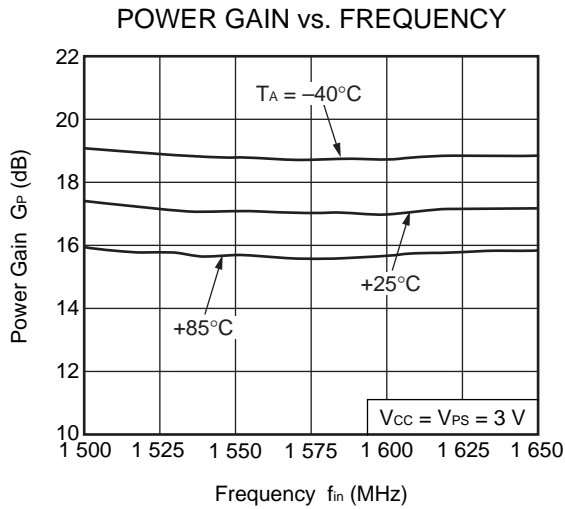

**Remark** The graphs indicate nominal characteristics.

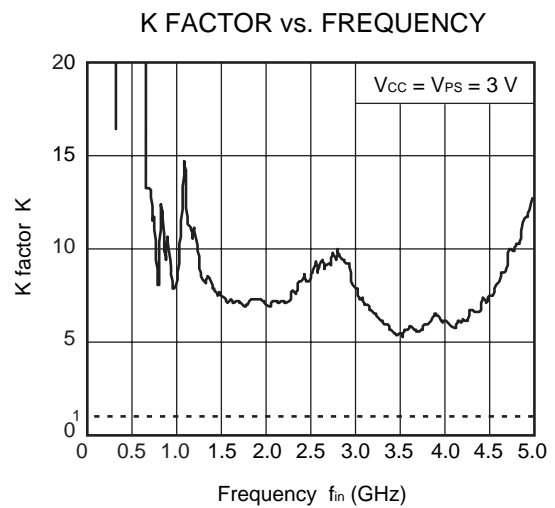
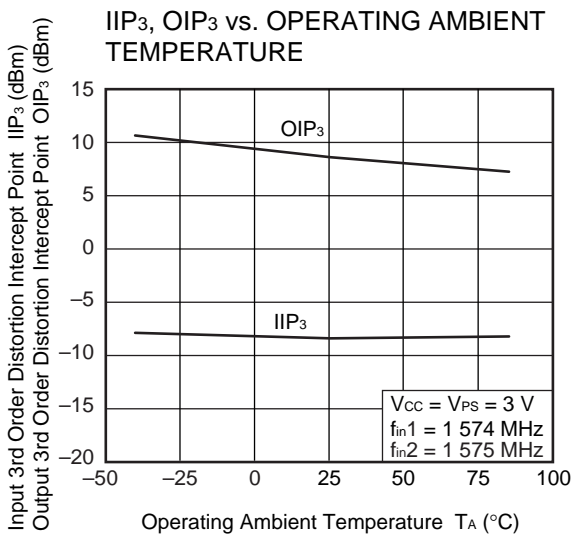
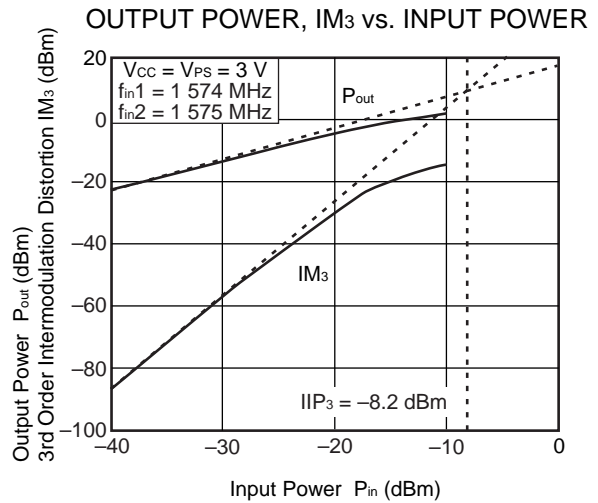
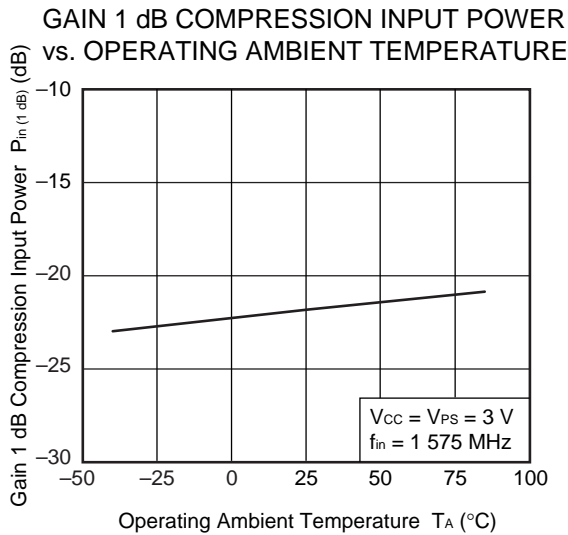
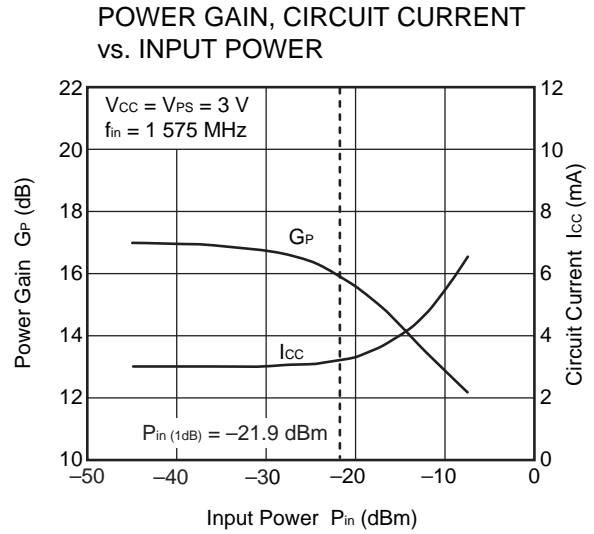
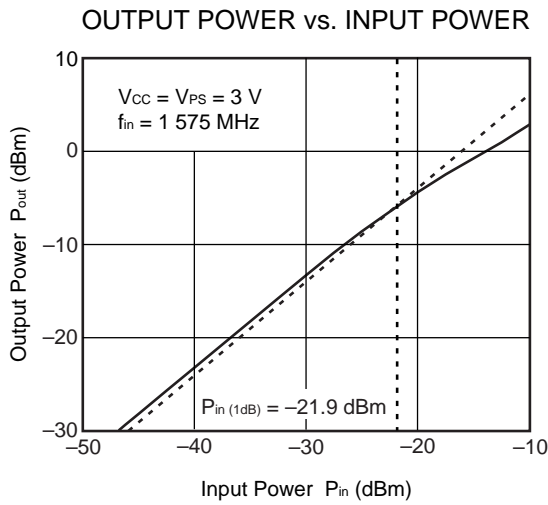

**Remark** The graphs indicate nominal characteristics.

CIRCUIT CURRENT vs. SUPPLY VOLTAGE

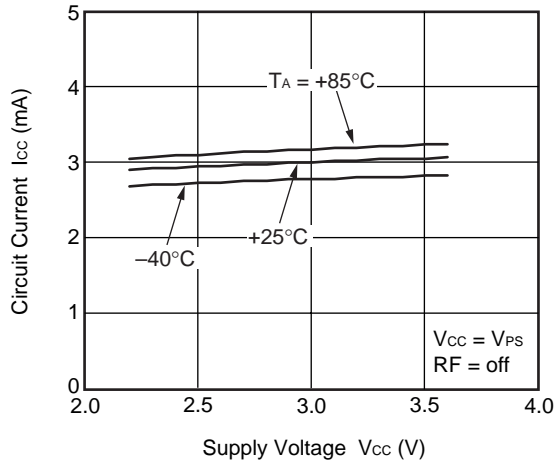

CIRCUIT CURRENT vs. POWER-SAVING VOLTAGE

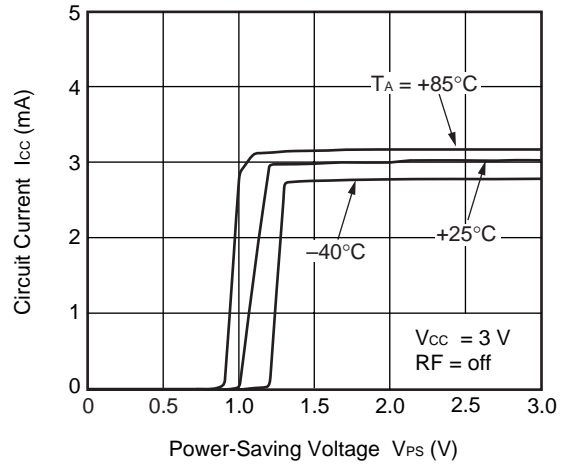

CIRCUIT CURRENT vs. OPERATING AMBIENT TEMPERATURE

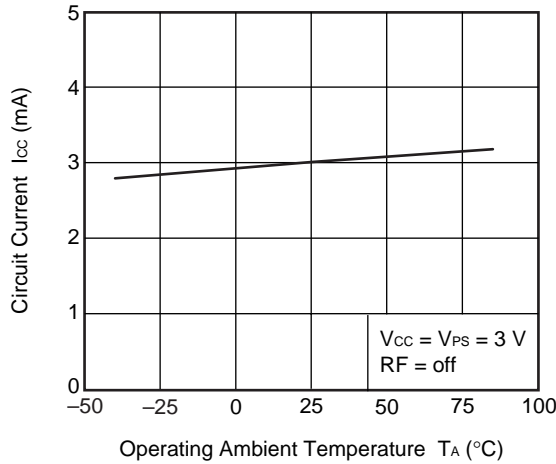

**Remark** The graphs indicate nominal characteristics.

**S-PARAMETERS** ( $T_A = +25^\circ\text{C}$ ,  $V_{CC} = V_{PS} = 3.0\text{ V}$ , monitored at connector on board)

S<sub>11</sub>-FREQUENCY

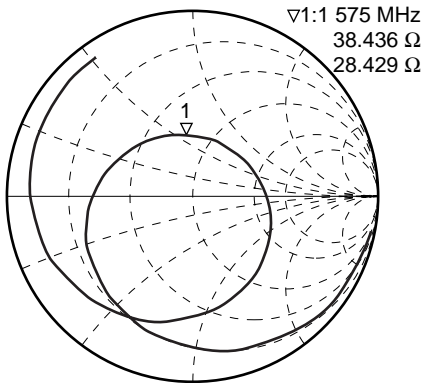

START 100.000 MHz STOP 4 100.000 MHz

S<sub>22</sub>-FREQUENCY

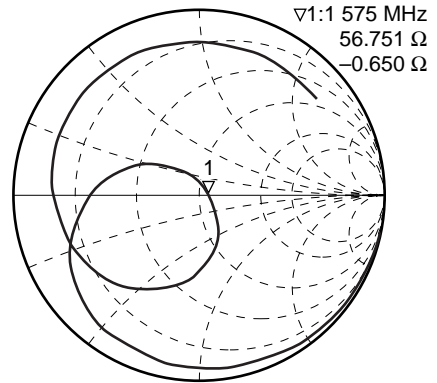

START 100.000 MHz STOP 4 100.000 MHz

INPUT RETURN LOSS vs. FREQUENCY

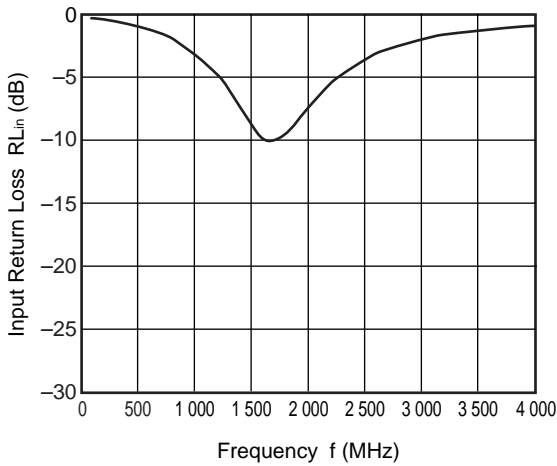

OUTPUT RETURN LOSS vs. FREQUENCY

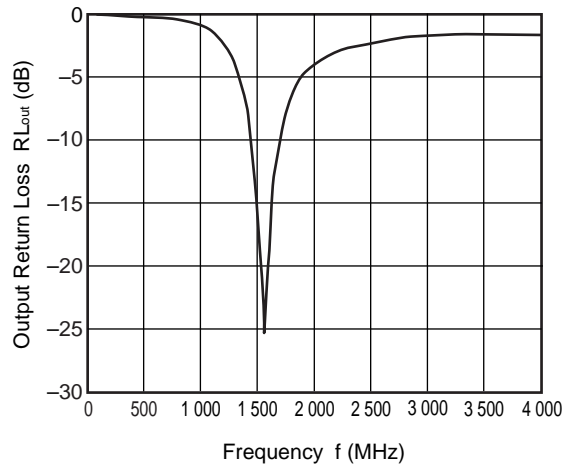

POWER GAIN vs. FREQUENCY

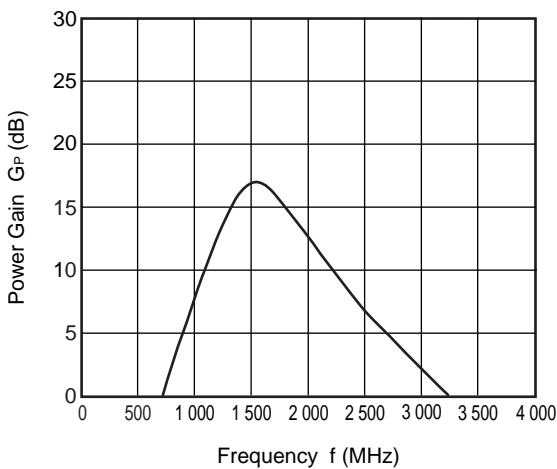

ISOLATION vs. FREQUENCY

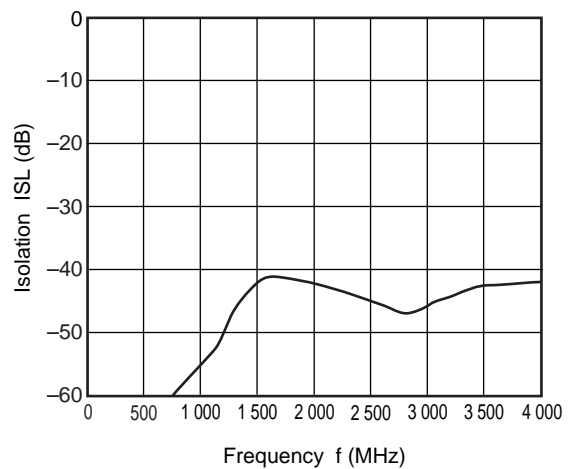

**Remark** The graphs indicate nominal characteristics.

**PACKAGE DIMENSIONS**

**6-PIN PLASTIC TSON (UNIT: mm)**

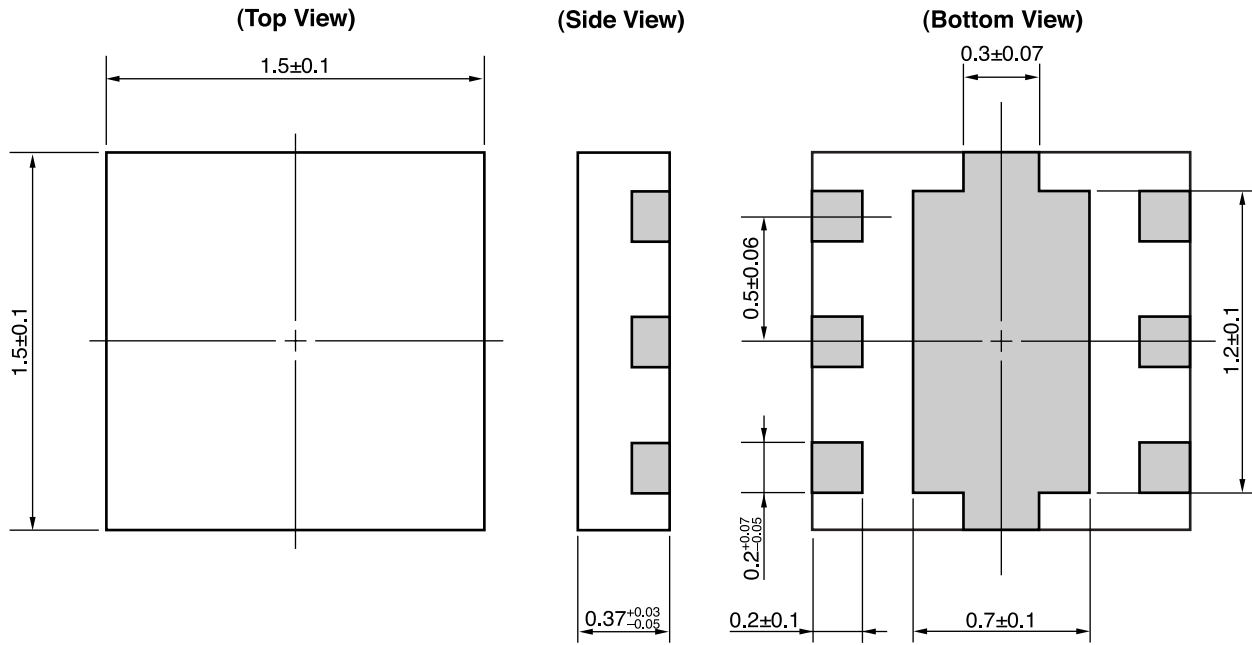



**NOTES ON CORRECT USE**

- (1) Observe precautions for handling because of electro-static sensitive devices.
- (2) Form a ground pattern as widely as possible to minimize ground impedance (to prevent undesired oscillation).  
All the ground terminals must be connected together with wide ground pattern to decrease impedance difference.
- (3) The bypass capacitor should be attached to Vcc line.
- (4) Do not supply DC voltage to INPUT pin.

**RECOMMENDED SOLDERING CONDITIONS**

This product should be soldered and mounted under the following recommended conditions. For soldering methods and conditions other than those recommended below, contact your nearby sales office.

Soldering Method	Soldering Conditions	Condition Symbol
Infrared Reflow	Peak temperature (package surface temperature) : 260°C or below Time at peak temperature : 10 seconds or less Time at temperature of 220°C or higher : 60 seconds or less Preheating time at 120 to 180°C : 120±30 seconds Maximum number of reflow processes : 3 times Maximum chlorine content of rosin flux (% mass) : 0.2%(Wt.) or below	IR260
Wave Soldering	Peak temperature (molten solder temperature) : 260°C or below Time at peak temperature : 10 seconds or less Preheating temperature (package surface temperature) : 120°C or below Maximum number of flow processes : 1 time Maximum chlorine content of rosin flux (% mass) : 0.2%(Wt.) or below	WS260
Partial Heating	Peak temperature (terminal temperature) : 350°C or below Soldering time (per side of device) : 3 seconds or less Maximum chlorine content of rosin flux (% mass) : 0.2%(Wt.) or below	HS350

**Caution Do not use different soldering methods together (except for partial heating).**

• **The information in this document is current as of July, 2007. The information is subject to change without notice. For actual design-in, refer to the latest publications of NEC Electronics data sheets or data books, etc., for the most up-to-date specifications of NEC Electronics products. Not all products and/or types are available in every country. Please check with an NEC Electronics sales representative for availability and additional information.**

• No part of this document may be copied or reproduced in any form or by any means without the prior written consent of NEC Electronics. NEC Electronics assumes no responsibility for any errors that may appear in this document.

• NEC Electronics does not assume any liability for infringement of patents, copyrights or other intellectual property rights of third parties by or arising from the use of NEC Electronics products listed in this document or any other liability arising from the use of such products. No license, express, implied or otherwise, is granted under any patents, copyrights or other intellectual property rights of NEC Electronics or others.

• Descriptions of circuits, software and other related information in this document are provided for illustrative purposes in semiconductor product operation and application examples. The incorporation of these circuits, software and information in the design of a customer's equipment shall be done under the full responsibility of the customer. NEC Electronics assumes no responsibility for any losses incurred by customers or third parties arising from the use of these circuits, software and information.

• While NEC Electronics endeavors to enhance the quality, reliability and safety of NEC Electronics products, customers agree and acknowledge that the possibility of defects thereof cannot be eliminated entirely. To minimize risks of damage to property or injury (including death) to persons arising from defects in NEC Electronics products, customers must incorporate sufficient safety measures in their design, such as redundancy, fire-containment and anti-failure features.

• NEC Electronics products are classified into the following three quality grades: "Standard", "Special" and "Specific".

The "Specific" quality grade applies only to NEC Electronics products developed based on a customer-designated "quality assurance program" for a specific application. The recommended applications of an NEC Electronics product depend on its quality grade, as indicated below. Customers must check the quality grade of each NEC Electronics product before using it in a particular application.

"Standard": Computers, office equipment, communications equipment, test and measurement equipment, audio and visual equipment, home electronic appliances, machine tools, personal electronic equipment and industrial robots.

"Special": Transportation equipment (automobiles, trains, ships, etc.), traffic control systems, anti-disaster systems, anti-crime systems, safety equipment and medical equipment (not specifically designed for life support).

"Specific": Aircraft, aerospace equipment, submersible repeaters, nuclear reactor control systems, life support systems and medical equipment for life support, etc.

The quality grade of NEC Electronics products is "Standard" unless otherwise expressly specified in NEC Electronics data sheets or data books, etc. If customers wish to use NEC Electronics products in applications not intended by NEC Electronics, they must contact an NEC Electronics sales representative in advance to determine NEC Electronics' willingness to support a given application.

(Note)

(1) "NEC Electronics" as used in this statement means NEC Electronics Corporation and also includes its majority-owned subsidiaries.

(2) "NEC Electronics products" means any product developed or manufactured by or for NEC Electronics (as defined above).

Subject: Compliance with EU Directives

CEL certifies, to its knowledge, that semiconductor and laser products detailed below are compliant with the requirements of European Union (EU) Directive 2002/95/EC Restriction on Use of Hazardous Substances in electrical and electronic equipment (RoHS) and the requirements of EU Directive 2003/11/EC Restriction on Penta and Octa BDE.

CEL Pb-free products have the same base part number with a suffix added. The suffix –A indicates that the device is Pb-free. The –AZ suffix is used to designate devices containing Pb which are exempted from the requirement of RoHS directive (\*). In all cases the devices have Pb-free terminals. All devices with these suffixes meet the requirements of the RoHS directive.

This status is based on CEL’s understanding of the EU Directives and knowledge of the materials that go into its products as of the date of disclosure of this information.

Restricted Substance per RoHS	Concentration Limit per RoHS (values are not yet fixed)	Concentration contained in CEL devices	
		-A	-AZ
Lead (Pb)	< 1000 PPM	Not Detected	(*)
Mercury	< 1000 PPM	Not Detected	
Cadmium	< 100 PPM	Not Detected	
Hexavalent Chromium	< 1000 PPM	Not Detected	
PBB	< 1000 PPM	Not Detected	
PBDE	< 1000 PPM	Not Detected	

If you should have any additional questions regarding our devices and compliance to environmental standards, please do not hesitate to contact your local representative.

Important Information and Disclaimer: Information provided by CEL on its website or in other communications concerning the substance content of its products represents knowledge and belief as of the date that it is provided. CEL bases its knowledge and belief on information provided by third parties and makes no representation or warranty as to the accuracy of such information. Efforts are underway to better integrate information from third parties. CEL has taken and continues to take reasonable steps to provide representative and accurate information but may not have conducted destructive testing or chemical analysis on incoming materials and chemicals. CEL and CEL suppliers consider certain information to be proprietary, and thus CAS numbers and other limited information may not be available for release.

In no event shall CEL’s liability arising out of such information exceed the total purchase price of the CEL part(s) at issue sold by CEL to customer on an annual basis.

See CEL Terms and Conditions for additional clarification of warranties and liability.



Компания «ЭлектроПласт» предлагает заключение долгосрочных отношений при поставках импортных электронных компонентов на взаимовыгодных условиях!

Наши преимущества:

- Оперативные поставки широкого спектра электронных компонентов отечественного и импортного производства напрямую от производителей и с крупнейших мировых складов;
- Поставка более 17-ти миллионов наименований электронных компонентов;
- Поставка сложных, дефицитных, либо снятых с производства позиций;
- Оперативные сроки поставки под заказ (от 5 рабочих дней);
- Экспресс доставка в любую точку России;
- Техническая поддержка проекта, помощь в подборе аналогов, поставка прототипов;
- Система менеджмента качества сертифицирована по Международному стандарту ISO 9001;
- Лицензия ФСБ на осуществление работ с использованием сведений, составляющих государственную тайну;
- Поставка специализированных компонентов (Xilinx, Altera, Analog Devices, Intersil, Interpoint, Microsemi, Aeroflex, Peregrine, Syfer, Eurofarad, Texas Instrument, Miteq, Cobham, E2V, MA-COM, Hittite, Mini-Circuits, General Dynamics и др.);

Помимо этого, одним из направлений компании «ЭлектроПласт» является направление «Источники питания». Мы предлагаем Вам помощь Конструкторского отдела:

- Подбор оптимального решения, техническое обоснование при выборе компонента;
- Подбор аналогов;
- Консультации по применению компонента;
- Поставка образцов и прототипов;
- Техническая поддержка проекта;
- Защита от снятия компонента с производства.



#### Как с нами связаться

**Телефон:** 8 (812) 309 58 32 (многоканальный)

**Факс:** 8 (812) 320-02-42

**Электронная почта:** [org@eplast1.ru](mailto:org@eplast1.ru)

**Адрес:** 198099, г. Санкт-Петербург, ул. Калинина, дом 2, корпус 4, литера А.