

**Single/Dual Low Bias Current, Low Voltage, Rail-to-Rail  
Input/Output CMOS Operational Amplifiers**
**AZV831/2**
**General Description**

The AZV831/AZV832 is single/dual channels rail-to-rail input and output amplifier, which provides a wide input common-mode voltage range and output voltage swing capability for maximum signal swings in low supply voltage applications. The device is fully specified to operate from 1.6V to 5.0V single supply, or  $\pm 0.8V$  and  $\pm 2.5V$  dual supply applications. It features very low supply current dissipation  $70\mu A$  per channel, which is well suitable for today's low-voltage and/or portable systems.

The AZV831/AZV832 features optimal performance in very low bias current of  $1pA$ , which enables the IC to be used for integrators, photodiode amplifiers, and piezoelectric sensors etc. The device has typical  $0.5mV$  input offset voltage and provides  $1MHz$  bandwidth.

The AZV831/AZV832 adopts the latest packaging technology to meet the most demanding space-constraint applications. The AZV831 is available in standard SOT-23-5 and SC-70-5 packages. The AZV832 is offered in the traditional MSOP-8 and SOIC-8 packages.

**Features**

- Single Supply Voltage Range: 1.6V to 5.5V
- Ultra-low Input Bias Current:  $1pA$  (Typ.)
- Offset Voltage:  $0.5mV$  (Typ.),  $2.5mV$  (Max.)
- Rail-to-Rail Input  
 $V_{CM}$ :  $300mV$  beyond Rails @  $V_{CC}=5V$
- Rail-to-Rail Output Swing:  
 $10k\Omega$  Load:  $4mV$  from Rail  
 $1k\Omega$  Load:  $25mV$  from Rail
- Supply Current:  $70\mu A$ /Amplifier
- Unity Gain Stable  
 Gain Bandwidth Product:  $1.0MHz$
- Slew Rate:  $0.45V/\mu s$  @  $V_{CC}=5.0V$
- Operation Ambient Temperature Range:  $-40^{\circ}C$  to  $85^{\circ}C$

**Applications**

- Sensors
- Photodiode Amplification
- Battery-Powered Instrumentation
- Pulse Blood Oximeter, Glucose Meter

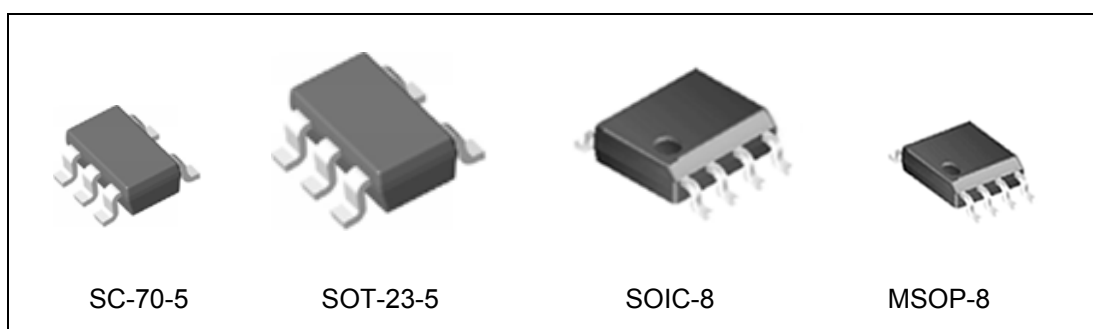

Figure 1. Package Types of AZV831/AZV832

**Single/Dual Low Bias Current, Low Voltage, Rail-to-Rail  
Input/Output CMOS Operational Amplifiers**

**AZV831/2**

**Pin Configuration**

KS/K Package  
(SC-70-5/SOT-23-5)

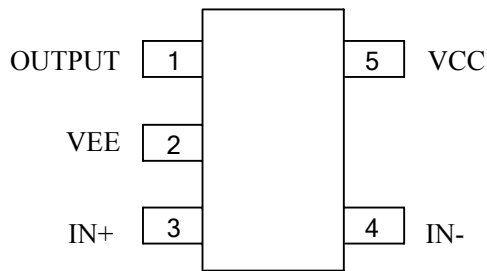

AZV831

M/MM Package  
(SOIC-8/MSOP-8)

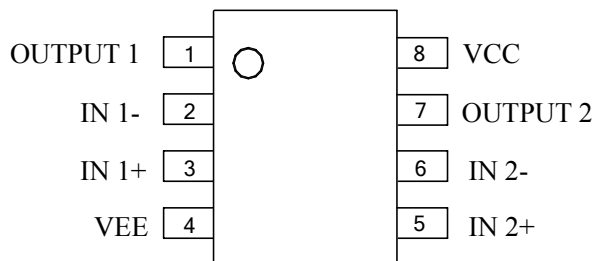

AZV832

Figure 2. Pin Configuration of AZV831/2 (Top View)

**Single/Dual Low Bias Current, Low Voltage, Rail-to-Rail  
Input/Output CMOS Operational Amplifiers**

**AZV831/2**

**Function Block Diagram**

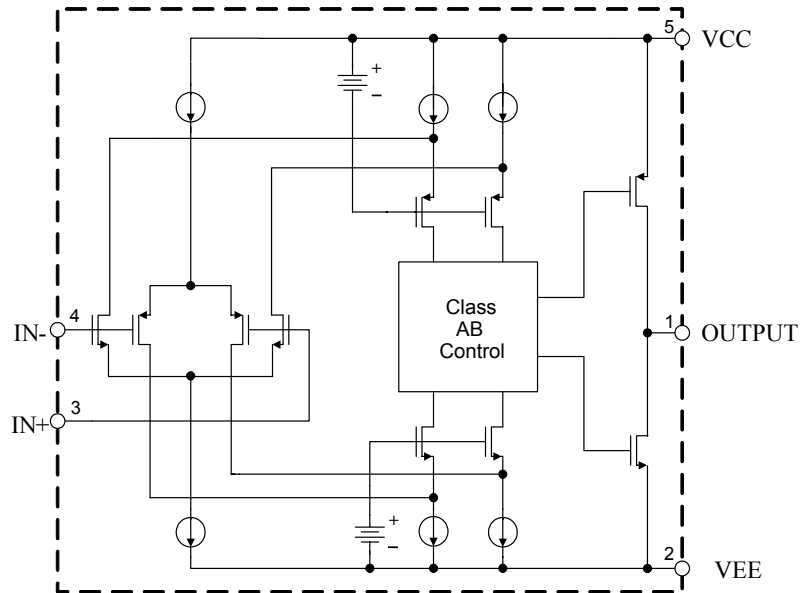

For AZV831

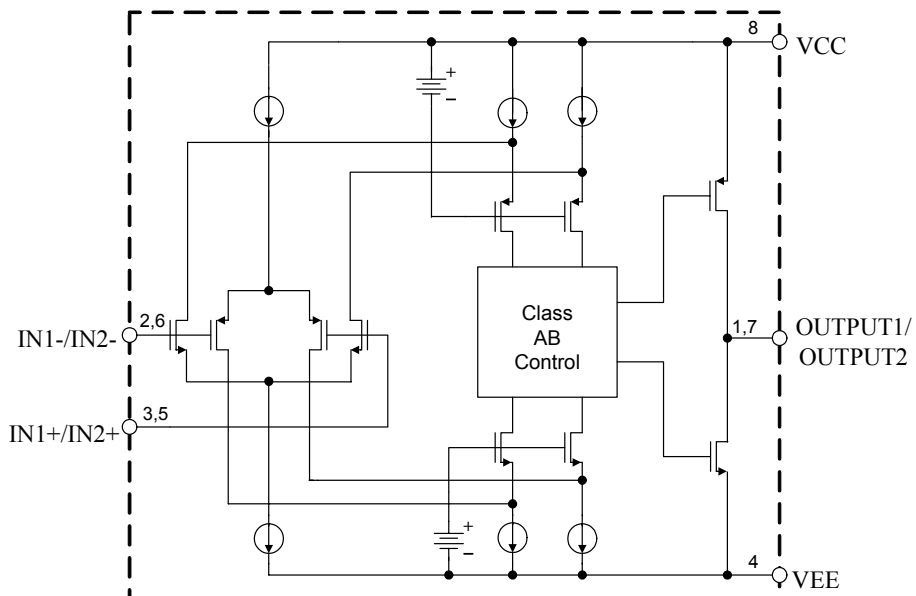

For AZV832/Amplifier

Figure 3. Functional Block Diagram of AZV831/2



**Single/Dual Low Bias Current, Low Voltage, Rail-to-Rail  
Input/Output CMOS Operational Amplifiers**

**AZV831/2**

**Ordering Information**

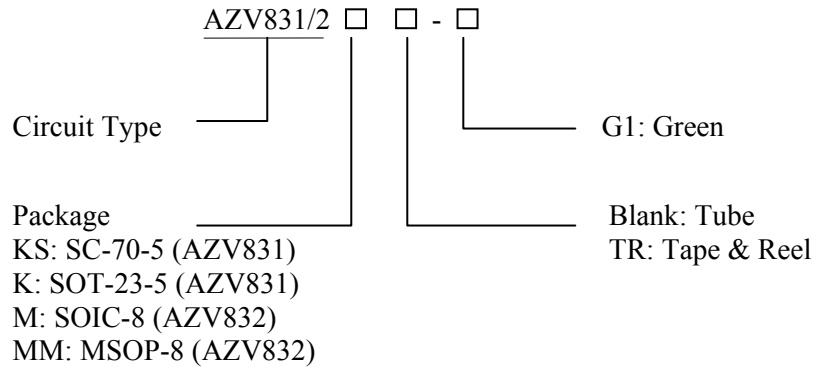

Package	Temperature Range	Part Number	Marking ID	Packing Type
SC-70-5	-40 to 85°C	AZV831KSTR-G1	L3	Tape & Reel
SOT-23-5	-40 to 85°C	AZV831KTR-G1	G4D	Tape & Reel
SOIC-8	-40 to 85°C	AZV832M-G1	832M-G1	Tube
		AZV832MTR-G1	832M-G1	Tape & Reel
MSOP-8	-40 to 85°C	AZV832MM-G1	832MM-G1	Tube
		AZV832MMTR-G1	832MM-G1	Tape & Reel

BCD Semiconductor's Pb-free products, as designated with "G1" suffix in the part number, are RoHS compliant and green.

**Single/Dual Low Bias Current, Low Voltage, Rail-to-Rail  
Input/Output CMOS Operational Amplifiers****AZV831/2****Absolute Maximum Ratings (Note 1)**

Parameter	Symbol	Value	Unit	
Power Supply Voltage	$V_{CC}$	6.0	V	
Differential Input Voltage	$V_{ID}$	6.0	V	
Input Voltage	$V_{IN}$	-0.3 to $V_{CC}+0.5$	V	
Operating Junction Temperature	$T_J$	150	°C	
Thermal Resistance (Junction to Ambient)	$\theta_{JA}$	SC-70-5	270	°C/W
		SOT-23-5	220	
		SOIC-8	150	
		MSOP-8	200	
Storage Temperature Range	$T_{STG}$	-65 to 150	°C	
Lead Temperature (Soldering,10 Seconds)	$T_{LEAD}$	260	°C	
ESD (Human Body Model)		4000	V	
ESD (Machine Model)		300	V	

Note 1: Stresses greater than those listed under “Absolute Maximum Ratings” may cause permanent damage to the device. These are stress ratings only, and functional operation of the device at these or any other conditions beyond those indicated under “Recommended Operating Conditions” is not implied. Exposure to “Absolute Maximum Ratings” for extended periods may affect device reliability.

**Recommended Operating Conditions**

Parameter	Symbol	Min	Max	Unit
Supply Voltage	$V_{CC}$	1.6	5.5	V
Operation Ambient Temperature Range	$T_A$	-40	85	°C



**Single/Dual Low Bias Current, Low Voltage, Rail-to-Rail  
Input/Output CMOS Operational Amplifiers**

**AZV831/2**

**1.6V DC Electrical Characteristics**

$V_{CC}=1.6V$ ,  $V_{EE}=0$ ,  $V_{OUT}=V_{CC}/2$ ,  $V_{CM}=V_{CC}/2$ ,  $T_A=25^{\circ}C$ , unless otherwise noted.

Parameter	Symbol	Conditions	Min	Typ	Max	Unit
Input Offset Voltage	$V_{OS}$			0.5	2.5	mV
Input Bias Current	$I_B$			1.0		pA
Input Offset Current	$I_{OS}$			1.0		pA
Input Common-mode Voltage Range	$V_{CM}$		-0.2		1.8	V
Common-mode Rejection Ratio	CMRR	$V_{CM}=-0.2V$ to $1.8V$	55	75		dB
Large Signal Voltage Gain	$G_V$	$R_L=10k\Omega$ to $V_{CC}/2$ , $V_{OUT}=0.2V$ to $1.4V$	90	110		dB
Input Offset Voltage Drift	$\Delta V_{OS}/\Delta T$			2.0		$\mu V/^{\circ}C$
Output Voltage Swing from Rail	$V_{OL}/V_{OH}$	$R_L=1k\Omega$ to $V_{CC}/2$		30	50	mV
		$R_L=10k\Omega$ to $V_{CC}/2$		3	15	
Output Current	Sink	$I_{SINK}$	$V_{OUT}=V_{CC}$	8	10	mA
	Source	$I_{SOURCE}$	$V_{OUT}=0V$	5	8.5	
Closed-loop Output Impedance	$Z_{OUT}$	$f=10kHz$ , $A_V=1$		9		$\Omega$
Power Supply Rejection Ratio	PSRR	$V_{CC}=1.6V$ to $5.0V$	66	80		dB
Supply Current (Per Amplifier)	$I_{CC}$	$V_{OUT}=V_{CC}/2$ , $I_{OUT}=0$		70	90	$\mu A$

**1.6V AC Electrical Characteristics**

$V_{CC}=1.6V$ ,  $V_{EE}=0$ ,  $V_{OUT}=V_{CC}/2$ ,  $V_{CM}=V_{CC}/2$ ,  $T_A=25^{\circ}C$ , unless otherwise noted.

Parameter	Symbol	Conditions	Min	Typ	Max	Unit
Gain Bandwidth Product	GBP	$R_L=100k\Omega$		1.0		MHz
Slew Rate (Note 2)	SR	1V Step, $C_L=100pF$ , $R_L=10k\Omega$		0.32		$V/\mu s$
Phase Margin	$\phi_M$	$R_L=100k\Omega$		67		Degrees
Total Harmonic Distortion+Noise	THD+N	$f=1kHz$ , $A_V=1$ , $V_{IN}=1V_{pp}$ $R_L=10k\Omega$ , $C_L=100pF$		-70		dB
Voltage Noise Density	$e_n$	$f=1kHz$		27		$nV/\sqrt{Hz}$

Note 2: Number specified is the positive slew rate.



**Single/Dual Low Bias Current, Low Voltage, Rail-to-Rail  
Input/Output CMOS Operational Amplifiers**

**AZV831/2**

**1.8V DC Electrical Characteristics**

$V_{CC}=1.8V, V_{EE}=0, V_{OUT}=V_{CC}/2, V_{CM}=V_{CC}/2, T_A=25^{\circ}C$ , unless otherwise noted.

Parameter	Symbol	Conditions	Min	Typ	Max	Unit
Input Offset Voltage	$V_{OS}$			0.5	2.5	mV
Input Bias Current	$I_B$			1.0		pA
Input Offset Current	$I_{OS}$			1.0		pA
Input Common-mode Voltage Range	$V_{CM}$		-0.2		2.0	V
Common-mode Rejection Ratio	CMRR	$V_{CM}=-0.2V$ to $2.0V$	55	75		dB
Large Signal Voltage Gain	$G_V$	$R_L=10k\Omega$ to $V_{CC}/2$ , $V_{OUT}=0.2V$ to $1.6V$	90	112		dB
Input Offset Voltage Drift	$\Delta V_{OS}/\Delta T$			2.0		$\mu V/^{\circ}C$
Output Voltage Swing from Rail	$V_{OL}/V_{OH}$	$R_L=1k\Omega$ to $V_{CC}/2$		25	50	mV
		$R_L=10k\Omega$ to $V_{CC}/2$		3	15	
Output Current	Sink	$I_{SINK}$	$V_{OUT}=V_{CC}$	12	16	mA
	Source	$I_{SOURCE}$	$V_{OUT}=0V$	10	14	
Closed-loop Output Impedance	$Z_{OUT}$	$f=10kHz$		9		$\Omega$
Power Supply Rejection Ratio	PSRR	$V_{CC}=1.6V$ to $5.0V$	66	80		dB
Supply Current (Per Amplifier)	$I_{CC}$	$V_{OUT}=V_{CC}/2, I_{OUT}=0$		70	90	$\mu A$

**1.8V AC Electrical Characteristics**

$V_{CC}=1.8V, V_{EE}=0, V_{OUT}=V_{CC}/2, V_{CM}=V_{CC}/2, T_A=25^{\circ}C$ , unless otherwise noted.

Parameter	Symbol	Conditions	Min	Typ	Max	Unit
Gain Bandwidth Product	GBP	$R_L=100k\Omega$		1.0		MHz
Slew Rate (Note 2)	SR	1V Step, $C_L=100pF, R_L=10k\Omega$		0.34		$V/\mu s$
Phase Margin	$\phi_M$	$R_L=100k\Omega$		67		Degrees
Total Harmonic Distortion+Noise	THD+N	$f=1kHz, A_V=1, V_{IN}=1V_{pp}$ $R_L=10k\Omega, C_L=100pF$		-70		dB
Voltage Noise Density	$e_n$	$f=1kHz$		27		$nV/\sqrt{Hz}$

Note 2: Number specified is the positive slew rate.



**Single/Dual Low Bias Current, Low Voltage, Rail-to-Rail  
Input/Output CMOS Operational Amplifiers**

**AZV831/2**

**3.0V DC Electrical Characteristics**

$V_{CC}=3.0V, V_{EE}=0, V_{OUT}=V_{CC}/2, V_{CM}=V_{CC}/2, T_A=25^{\circ}C$ , unless otherwise noted.

Parameter	Symbol	Conditions	Min	Typ	Max	Unit
Input Offset Voltage	$V_{OS}$			0.5	2.5	mV
Input Bias Current	$I_B$			1.0		pA
Input Offset Current	$I_{OS}$			1.0		pA
Input Common-mode Voltage Range	$V_{CM}$		-0.3		3.3	V
Common-mode Rejection Ratio	CMRR	$V_{CM}=-0.3V$ to 1.8V	62	80		dB
		$V_{CM}=-0.3V$ to 3.3V	58	75		
Large Signal Voltage Gain	$G_V$	$R_L=1k\Omega$ to $V_{CC}/2$ , $V_{OUT}=0.2V$ to 2.8V	90	110		dB
		$R_L=10k\Omega$ to $V_{CC}/2$ , $V_{OUT}=0.1V$ to 2.9V	95	115		
Input Offset Voltage Drift	$\Delta V_{OS}/\Delta T$			2.0		$\mu V/^{\circ}C$
Output Voltage Swing from Rail	$V_{OL}/V_{OH}$	$R_L=1k\Omega$ to $V_{CC}/2$		20	50	mV
		$R_L=10k\Omega$ to $V_{CC}/2$		3	15	
Output Current	Sink	$I_{SINK}$	$V_{OUT}=V_{CC}$	50	60	mA
	Source	$I_{SOURCE}$	$V_{OUT}=0V$	50	65	
Closed-loop Output Impedance	$Z_{OUT}$	$f=10kHz$		9		$\Omega$
Power Supply Rejection Ratio	PSRR	$V_{CC}=1.6V$ to 5.0V	66	80		dB
Supply Current (Per Amplifier)	$I_{CC}$	$V_{OUT}=V_{CC}/2, I_{OUT}=0$		70	90	$\mu A$

**3.0V AC Electrical Characteristics**

$V_{CC}=3.0V, V_{EE}=0, V_{OUT}=V_{CC}/2, V_{CM}=V_{CC}/2, T_A=25^{\circ}C$ , unless otherwise noted.

Parameter	Symbol	Conditions	Min	Typ	Max	Unit
Gain Bandwidth Product	GBP	$R_L=100k\Omega$		1.0		MHz
Slew Rate (Note 2)	SR	$G=1, 2V$ Step, $C_L=100pF, R_L=10k\Omega$		0.40		V/ $\mu s$
Phase Margin	$\phi_M$	$R_L=100k\Omega$		67		Degrees
Total Harmonic Distortion+Noise	THD+N	$f=1kHz, G=1, V_{IN}=1V_{pp}$ $R_L=10k\Omega, C_L=100pF$		-70		dB
Voltage Noise Density	$e_n$	$f=1kHz$		27		$nV/\sqrt{Hz}$

Note 2: Number specified is the positive slew rate.





**Single/Dual Low Bias Current, Low Voltage, Rail-to-Rail  
Input/Output CMOS Operational Amplifiers**

**AZV831/2**

**5.0V DC Electrical Characteristics**

$V_{CC}=5.0V$ ,  $V_{EE}=0$ ,  $V_{OUT}=V_{CC}/2$ ,  $V_{CM}=V_{CC}/2$ ,  $T_A=25^\circ C$ , unless otherwise noted.

Parameter	Symbol	Conditions	Min	Typ	Max	Unit
Input Offset Voltage	$V_{OS}$			0.5	2.5	mV
Input Bias Current	$I_B$			1.0		pA
Input Offset Current	$I_{OS}$			1.0		pA
Input Common-mode Voltage Range	$V_{CM}$		-0.3		5.3	V
Common-mode Rejection Ratio	CMRR	$V_{CM}=-0.3V$ to $3.8V$	70	85		dB
		$V_{CM}=-0.3V$ to $5.3V$	65	90		
Large Signal Voltage Gain	$G_V$	$R_L=1k\Omega$ to $V_{CC}/2$ , $V_{OUT}=0.2V$ to $4.8V$	80	92		dB
		$R_L=10k\Omega$ to $V_{CC}/2$ , $V_{OUT}=0.05V$ to $4.95V$	85	98		
Input Offset Voltage Drift	$\Delta V_{OS}/\Delta T$			2.0		$\mu V/^\circ C$
Output Voltage Swing from Rail	$V_{OL}/V_{OH}$	$R_L=1k\Omega$ to $V_{CC}/2$		25	50	mV
		$R_L=10k\Omega$ to $V_{CC}/2$		4	15	
Output Current	Sink	$I_{SINK}$	$V_{OUT}=V_{CC}$	100	150	mA
	Source	$I_{SOURCE}$	$V_{OUT}=0V$	110	185	
Closed-loop Output Impedance		$f=1kHz$ , $A_V=1$		9		$\Omega$
Power Supply Rejection Ratio	PSRR	$V_{CC}=1.6V$ to $5.0V$	66	80		dB
Supply Current (Per Amplifier)	$I_{CC}$	$V_{OUT}=V_{CC}/2$ , $I_{OUT}=0$		70	90	$\mu A$

**5V AC Electrical Characteristics**

$V_{CC}=5.0V$ ,  $V_{EE}=0$ ,  $V_{OUT}=V_{CC}/2$ ,  $V_{CM}=V_{CC}/2$ ,  $T_A=25^\circ C$ , unless otherwise noted.

Parameter	Symbol	Conditions	Min	Typ	Max	Unit
Gain Bandwidth Product	GBP	$R_L=100k\Omega$		1.0		MHz
Slew Rate (Note 2)	SR	2V Step, $C_L=100pF$ , $R_L=10k\Omega$		0.45		V/ $\mu s$
Phase Margin	$\phi_M$	$R_L=100k\Omega$		67		Degrees
THD+N	THD+N	$f=1kHz$ , $A_V=1$ , $V_{IN}=1V_{PP}$ $R_L=10k\Omega$ , $C_L=100pF$		-70		dB
Voltage Noise Density	$e_n$	$f=1kHz$		27		$nV/\sqrt{Hz}$

Note 2: Number specified is the positive slew rate.



Single/Dual Low Bias Current, Low Voltage, Rail-to-Rail  
Input/Output CMOS Operational Amplifiers

AZV831/2

Typical Performance Characteristics

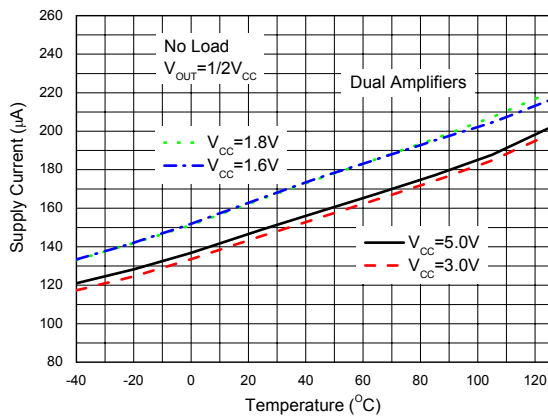

Figure 4. Supply Current vs. Temperature

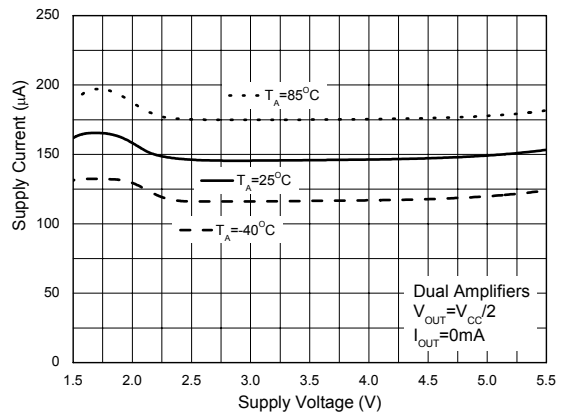

Figure 5. Supply Current vs. Supply Voltage

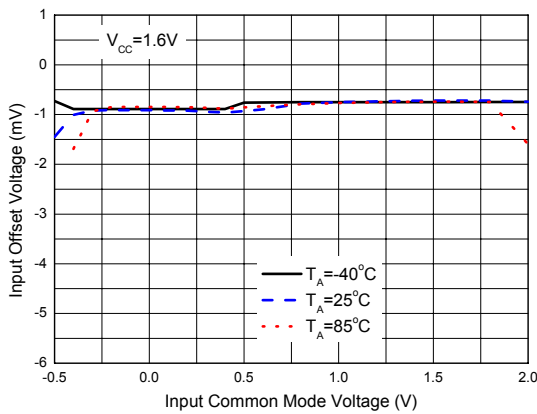

Figure 6. Input Offset Voltage vs. Input Common Mode Voltage

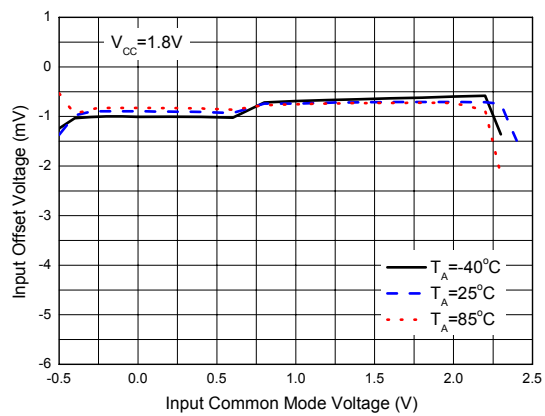

Figure 7. Input Offset Voltage vs. Input Common Mode Voltage

**Single/Dual Low Bias Current, Low Voltage, Rail-to-Rail  
Input/Output CMOS Operational Amplifiers**

**AZV831/2**

**Typical Performance Characteristics (Continued)**

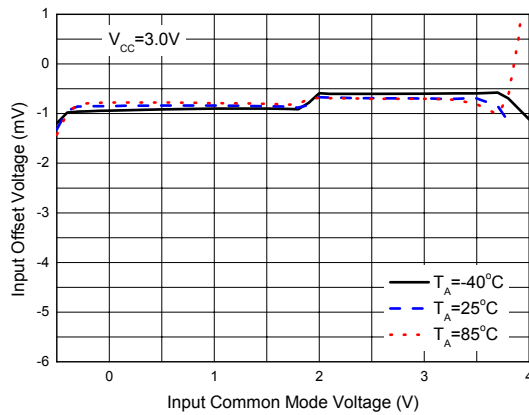

Figure 8. Input Offset Voltage vs. Input Common Mode Voltage

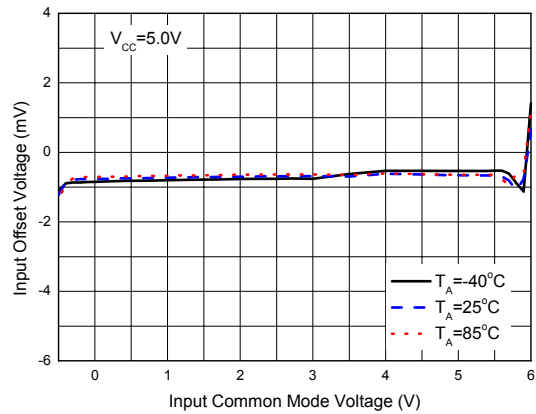

Figure 9. Input Offset Voltage vs. Input Common Mode Voltage

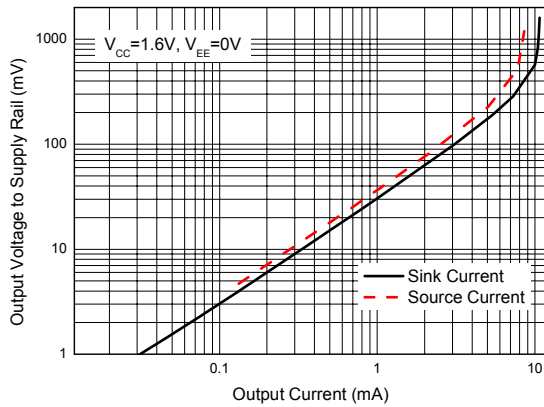

Figure 10. Output Voltage vs. Output Current

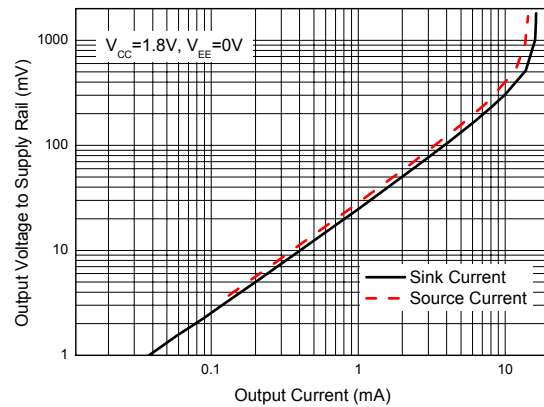

Figure 11. Output Voltage vs. Output Current



**Single/Dual Low Bias Current, Low Voltage, Rail-to-Rail  
Input/Output CMOS Operational Amplifiers**

**AZV831/2**

**Typical Performance Characteristics (Continued)**

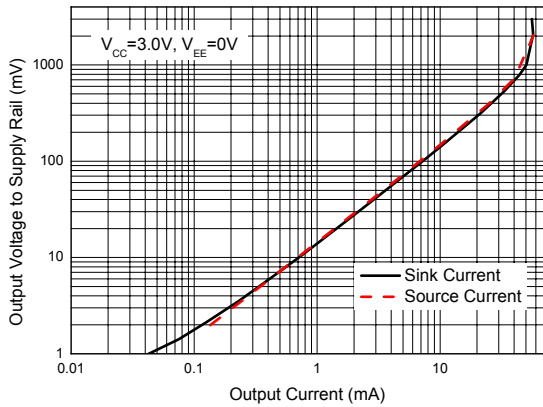

Figure 12. Output Voltage vs. Output Current

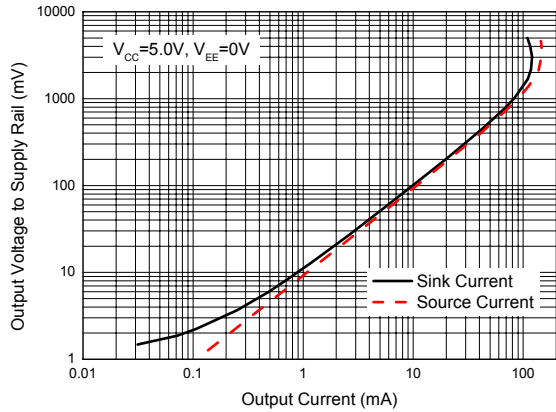

Figure 13. Output Voltage vs. Output Current

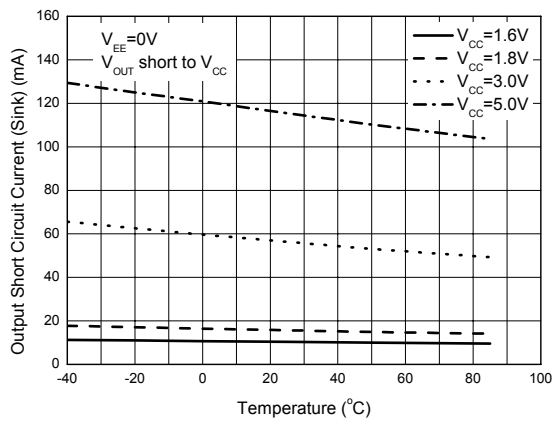

Figure 14. Output Short Circuit Current vs. Temperature

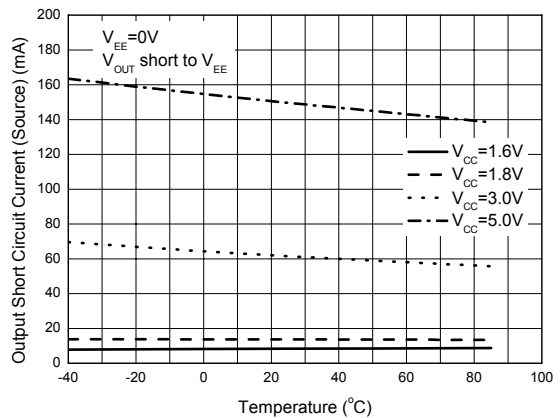

Figure 15. Output Short Circuit Current vs. Temperature



**Single/Dual Low Bias Current, Low Voltage, Rail-to-Rail  
Input/Output CMOS Operational Amplifiers**

**AZV831/2**

**Typical Performance Characteristics (Continued)**

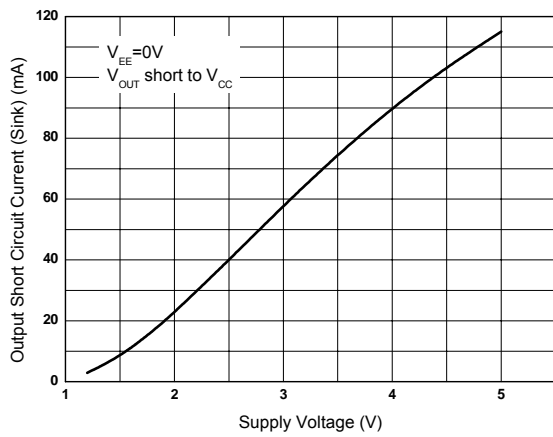

Figure 16. Output Short Circuit Current vs. Supply Voltage

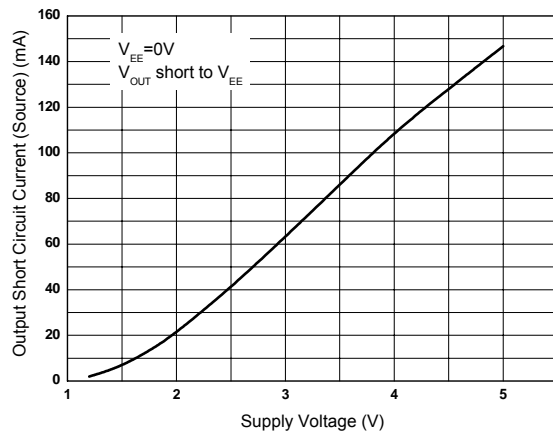

Figure 17. Output Short Circuit Current vs. Supply Voltage

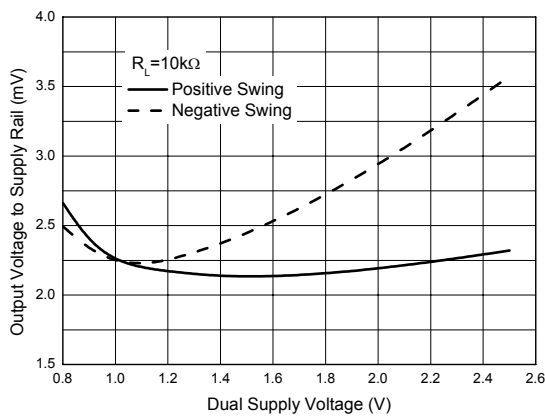

Figure 18. Output Voltage Swing vs. Supply Voltage

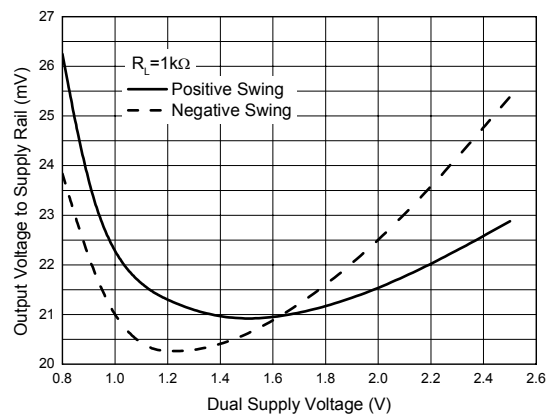

Figure 19. Output Voltage Swing vs. Supply Voltage

**Single/Dual Low Bias Current, Low Voltage, Rail-to-Rail  
Input/Output CMOS Operational Amplifiers**

**AZV831/2**

**Typical Performance Characteristics (Continued)**

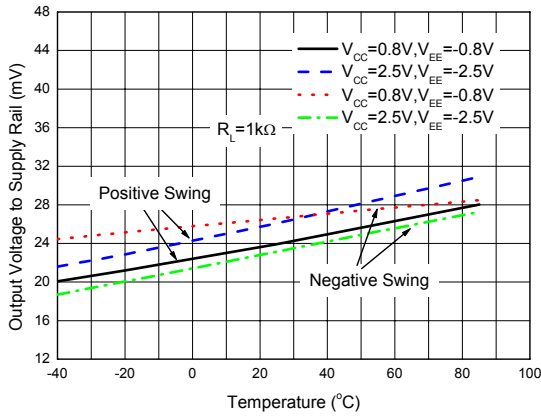

Figure 20. Output Voltage Swing vs. Temperature

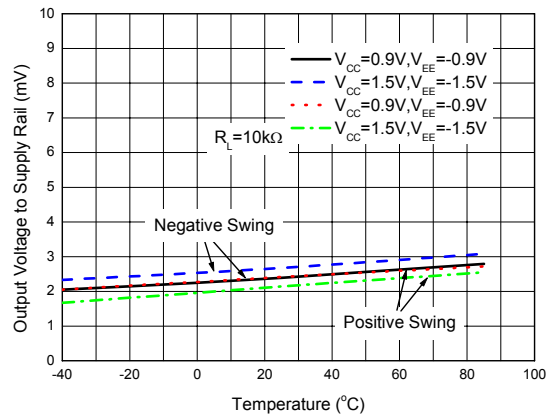

Figure 21. Output Voltage Swing vs. Temperature

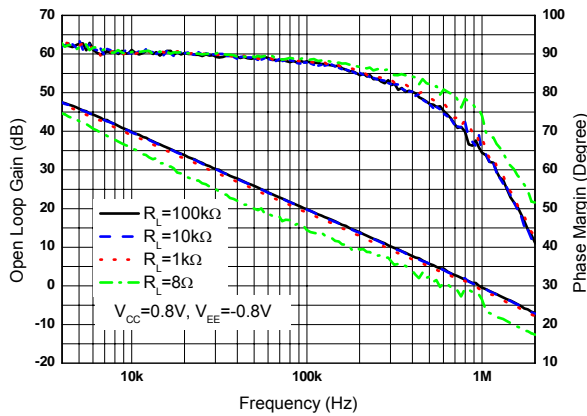

Figure 22. Gain and Phase vs. Frequency with Resistive Load

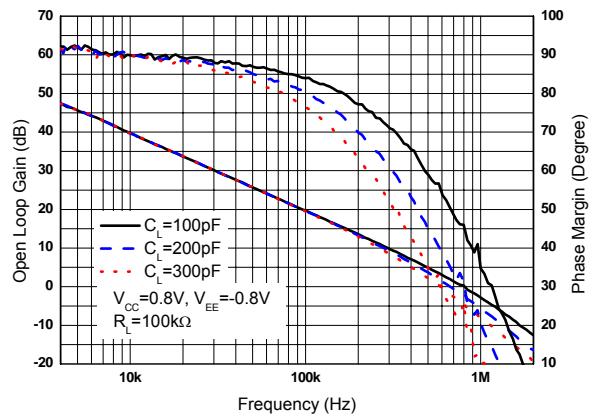

Figure 23. Gain and Phase vs. Frequency with Capacitive Load



Single/Dual Low Bias Current, Low Voltage, Rail-to-Rail  
Input/Output CMOS Operational Amplifiers

AZV831/2

Typical Performance Characteristics (Continued)

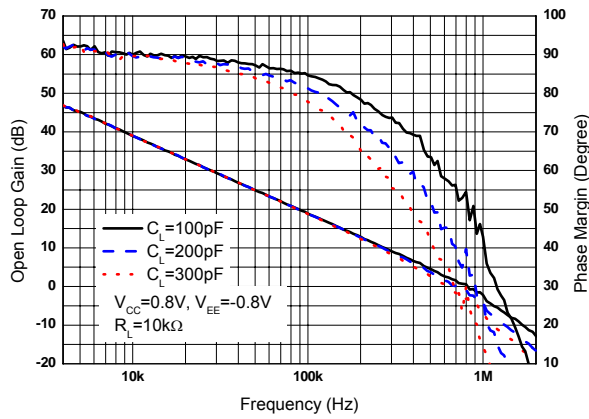

Figure 24. Gain and Phase vs. Frequency with Capacitive Load

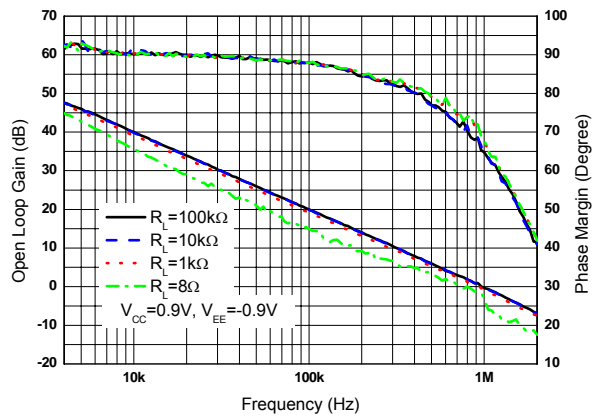

Figure 25. Gain and Phase vs. Frequency with Resistive Load

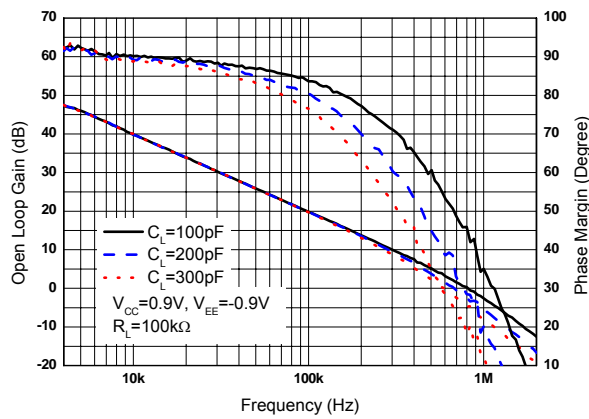

Figure 26. Gain and Phase vs. Frequency with Capacitive Load

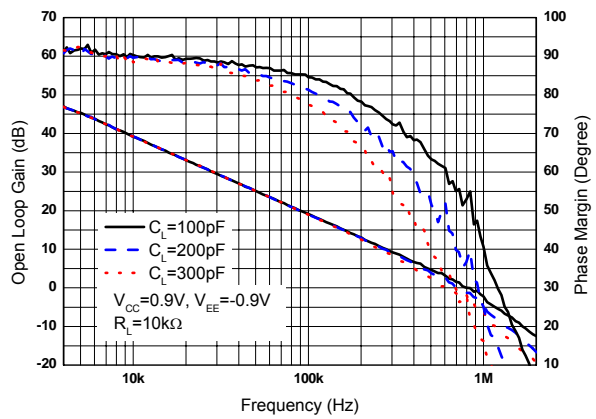

Figure 27. Gain and Phase vs. Frequency with Capacitive Load



Single/Dual Low Bias Current, Low Voltage, Rail-to-Rail  
Input/Output CMOS Operational Amplifiers

AZV831/2

Typical Performance Characteristics (Continued)

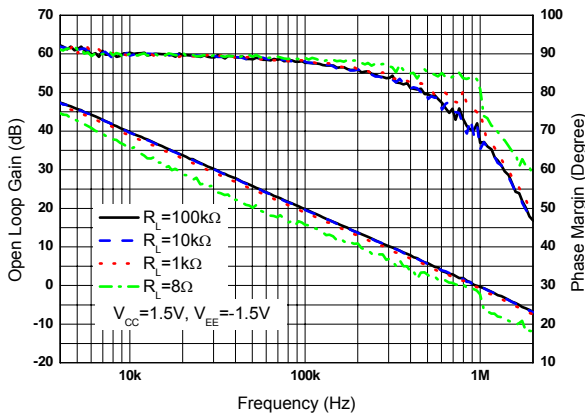

Figure 28. Gain and Phase vs. Frequency with Resistive Load

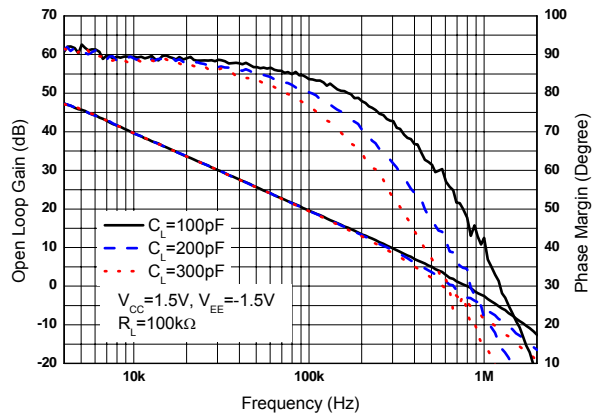

Figure 29. Gain and Phase vs. Frequency with Capacitive Load

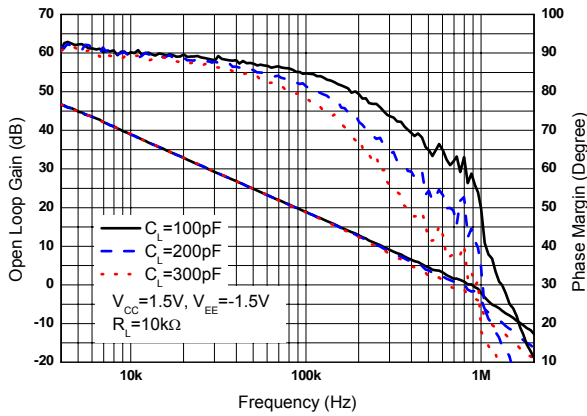

Figure 30. Gain and Phase vs. Frequency with Capacitive Load

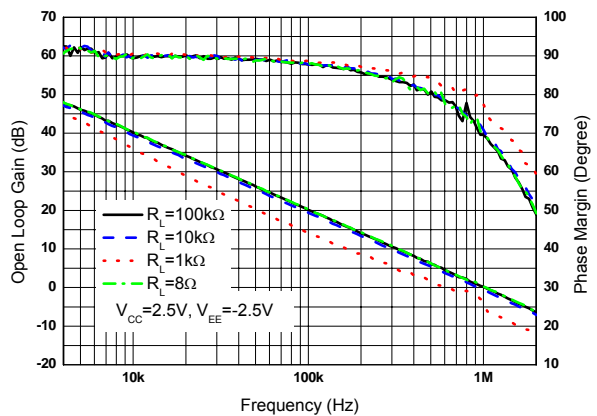

Figure 31. Gain and Phase vs. Frequency with Resistive Load



**Single/Dual Low Bias Current, Low Voltage, Rail-to-Rail  
Input/Output CMOS Operational Amplifiers**

**AZV831/2**

**Typical Performance Characteristics (Continued)**

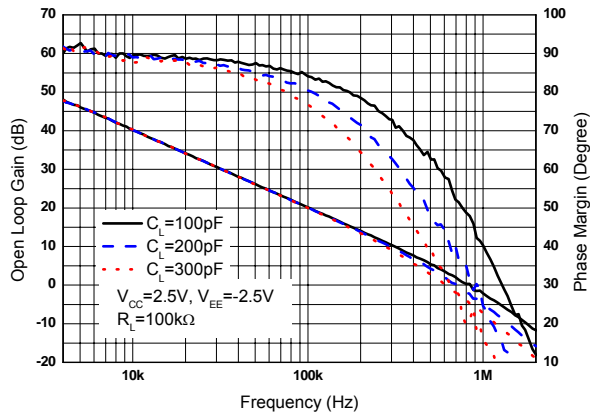

Figure 32. Gain and Phase vs. Frequency with Capacitive Load

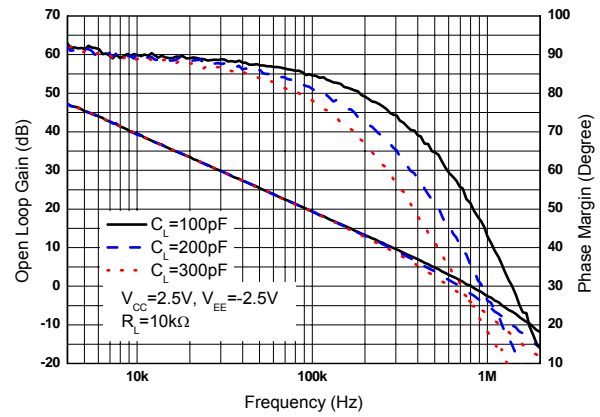

Figure 33. Gain and Phase vs. Frequency with Capacitive Load

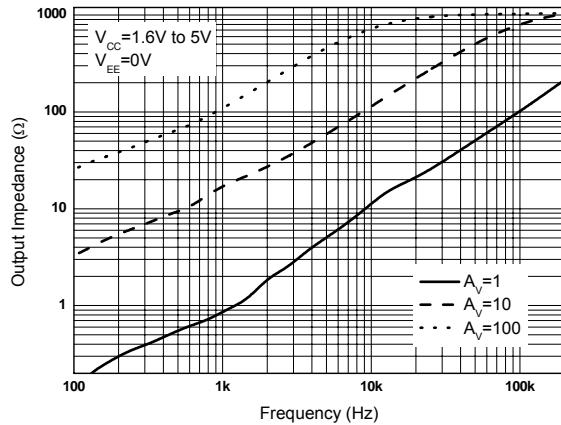

Figure 34. Output Impedance vs. Frequency

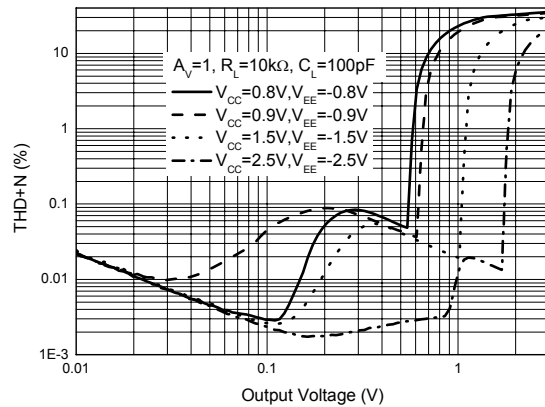

Figure 35. THD+N vs. Output Voltage

**Single/Dual Low Bias Current, Low Voltage, Rail-to-Rail  
Input/Output CMOS Operational Amplifiers**

**AZV831/2**

**Typical Performance Characteristics (Continued)**

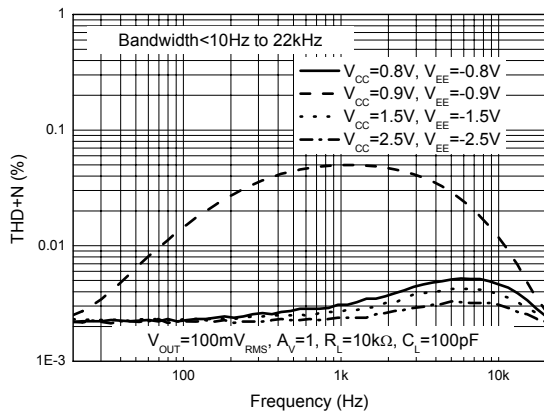

Figure 36. THD+N vs. Frequency

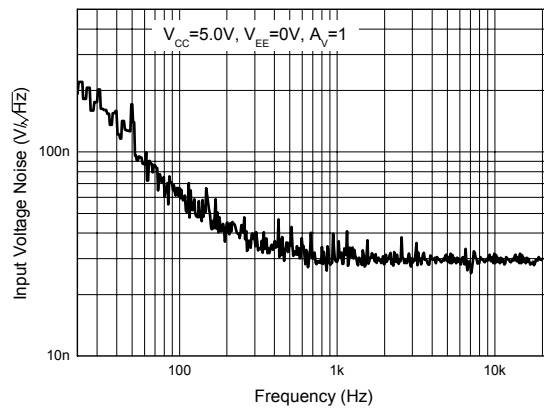
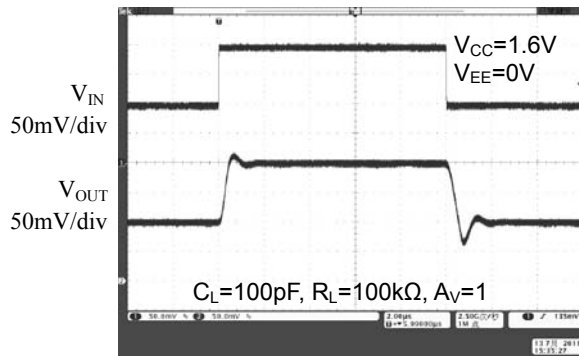
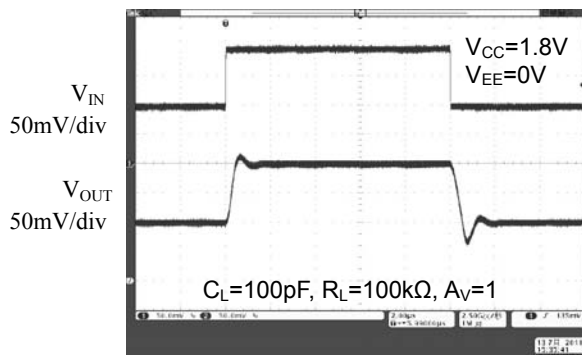

Figure 37. Input Voltage Noise Density



Time ( $2\mu\text{s}/\text{div}$ )

Figure 38. Small Signal Pulse Response



Time ( $2\mu\text{s}/\text{div}$ )

Figure 39. Small Signal Pulse Response

**Single/Dual Low Bias Current, Low Voltage, Rail-to-Rail  
Input/Output CMOS Operational Amplifiers**
**AZV831/2**
**Typical Performance Characteristics (Continued)**

 Time (2 $\mu$ s/div)

Figure 40. Small Signal Pulse Response

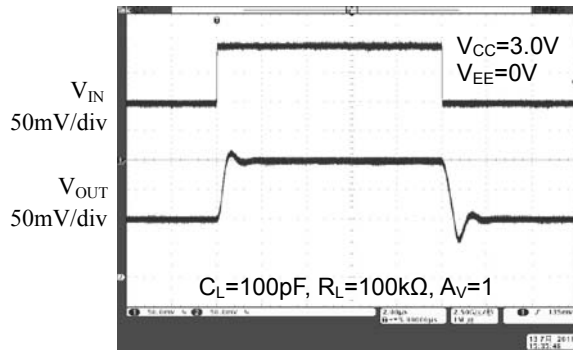

 Time (2 $\mu$ s/div)

Figure 41. Small Signal Pulse Response

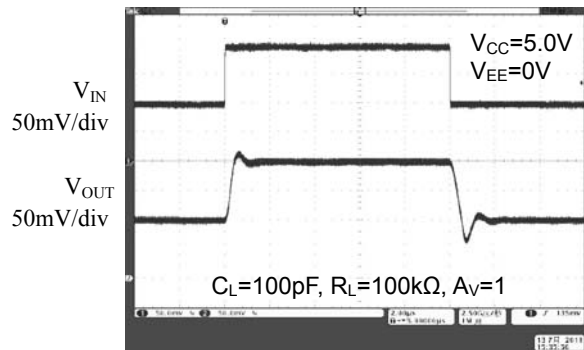

 Time (10 $\mu$ s/div)

Figure 42. Large Signal Pulse Response

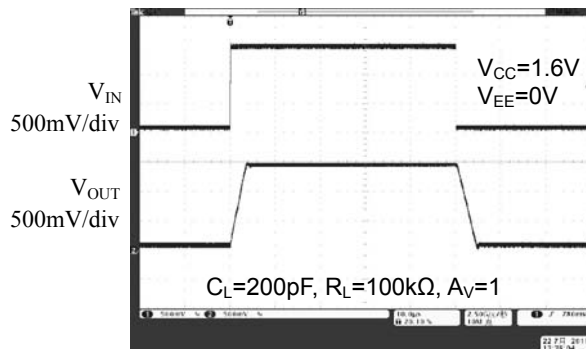

 Time (10 $\mu$ s/div)

Figure 43. Large Signal Pulse Response

**Single/Dual Low Bias Current, Low Voltage, Rail-to-Rail  
Input/Output CMOS Operational Amplifiers**

**AZV831/2**

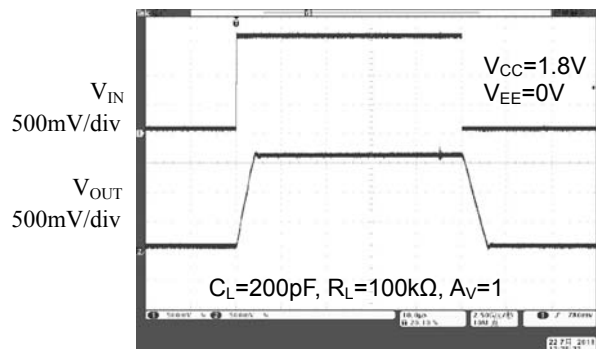
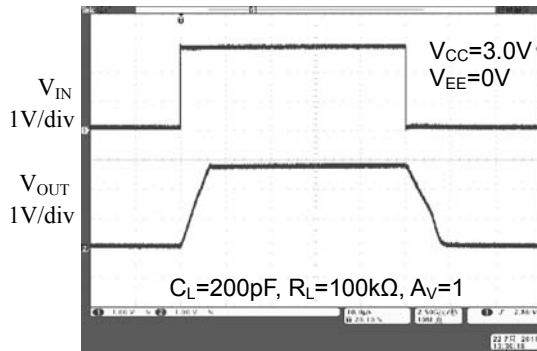
**Typical Performance Characteristics (Continued)**



Time (10μs/div)

Figure 44. Large Signal Pulse Response

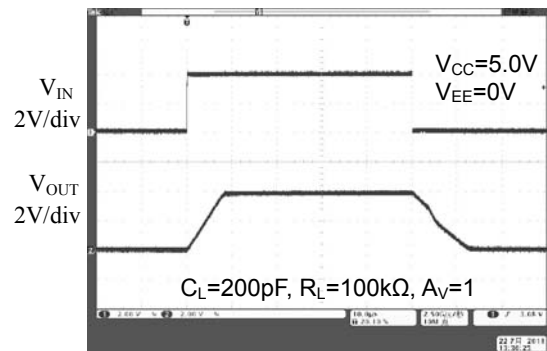

Time (10μs/div)

Figure 45. Large Signal Pulse Response

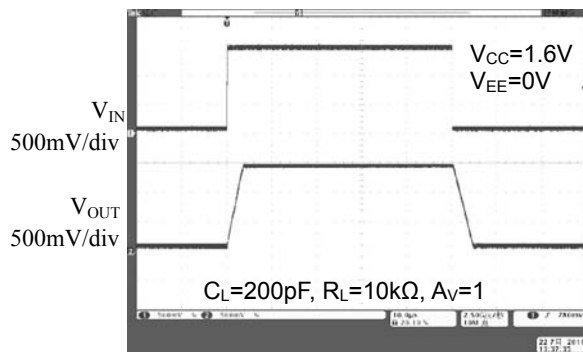

Time (10μs/div)

Figure 46. Large Signal Pulse Response

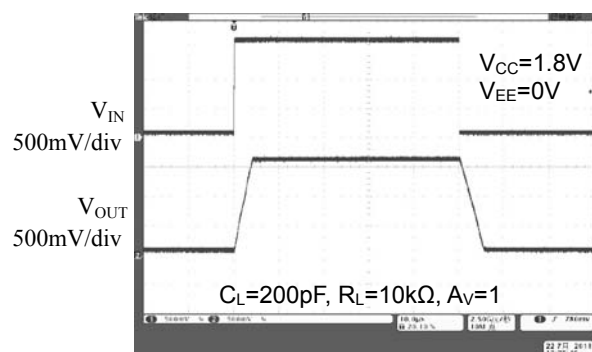

Time (10μs/div)

Figure 47. Large Signal Pulse Response

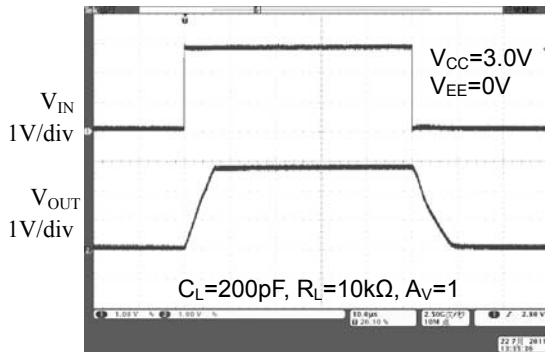
**Single/Dual Low Bias Current, Low Voltage, Rail-to-Rail  
Input/Output CMOS Operational Amplifiers**
**AZV831/2**
**Typical Performance Characteristics (Continued)**

Time (10µs/div)

Figure 48. Large Signal Pulse Response

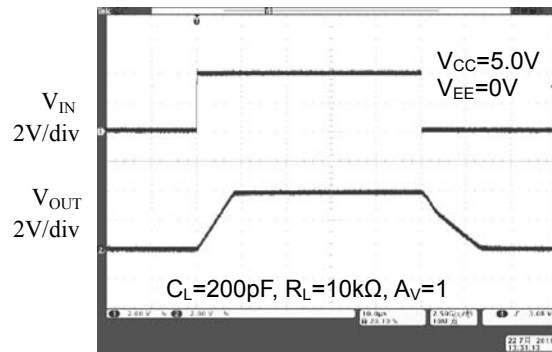

Time (10µs/div)

Figure 49. Large Signal Pulse Response

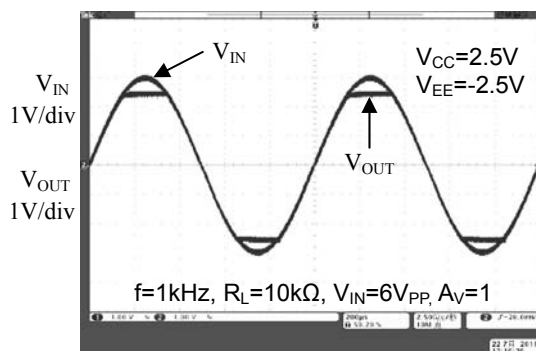

Time (200µs/div)

Figure 50. No Phase Reversal

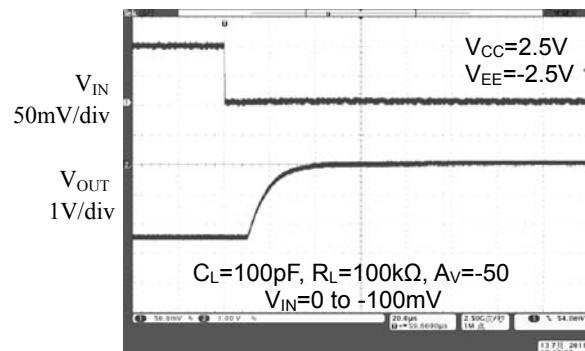

Time (20µs/div)

Figure 51. Overload Recovery Time

**Single/Dual Low Bias Current, Low Voltage, Rail-to-Rail  
Input/Output CMOS Operational Amplifiers****AZV831/2****Typical Performance Characteristics (Continued)**

Figure 52. Overload Recovery Time

**Single/Dual Low Bias Current, Low Voltage, Rail-to-Rail  
Input/Output CMOS Operational Amplifiers**

**AZV831/2**

**Mechanical Dimensions**

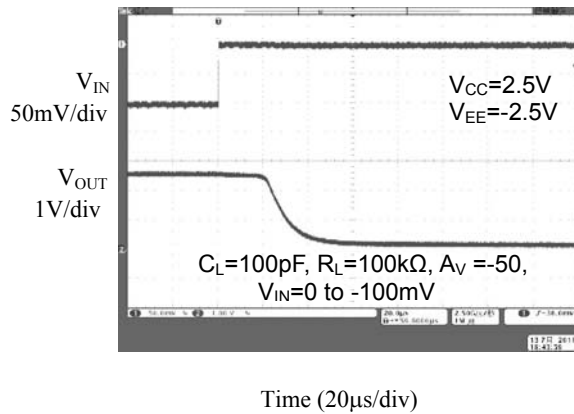
**SC-70-5**

**Unit: mm(inch)**

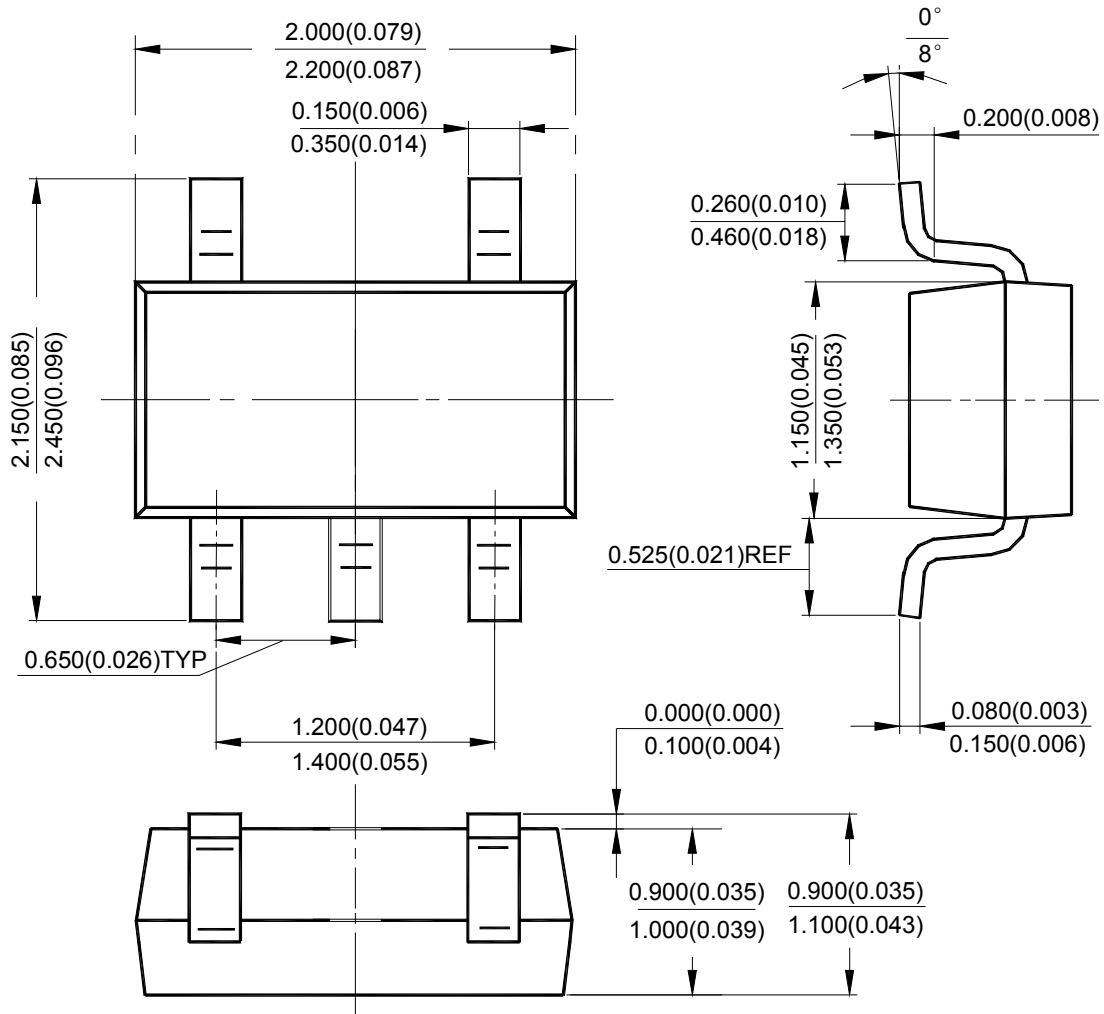



**Single/Dual Low Bias Current, Low Voltage, Rail-to-Rail  
Input/Output CMOS Operational Amplifiers**

**AZV831/2**

**Mechanical Dimensions (Continued)**

**SOT-23-5**

**Unit: mm(inch)**

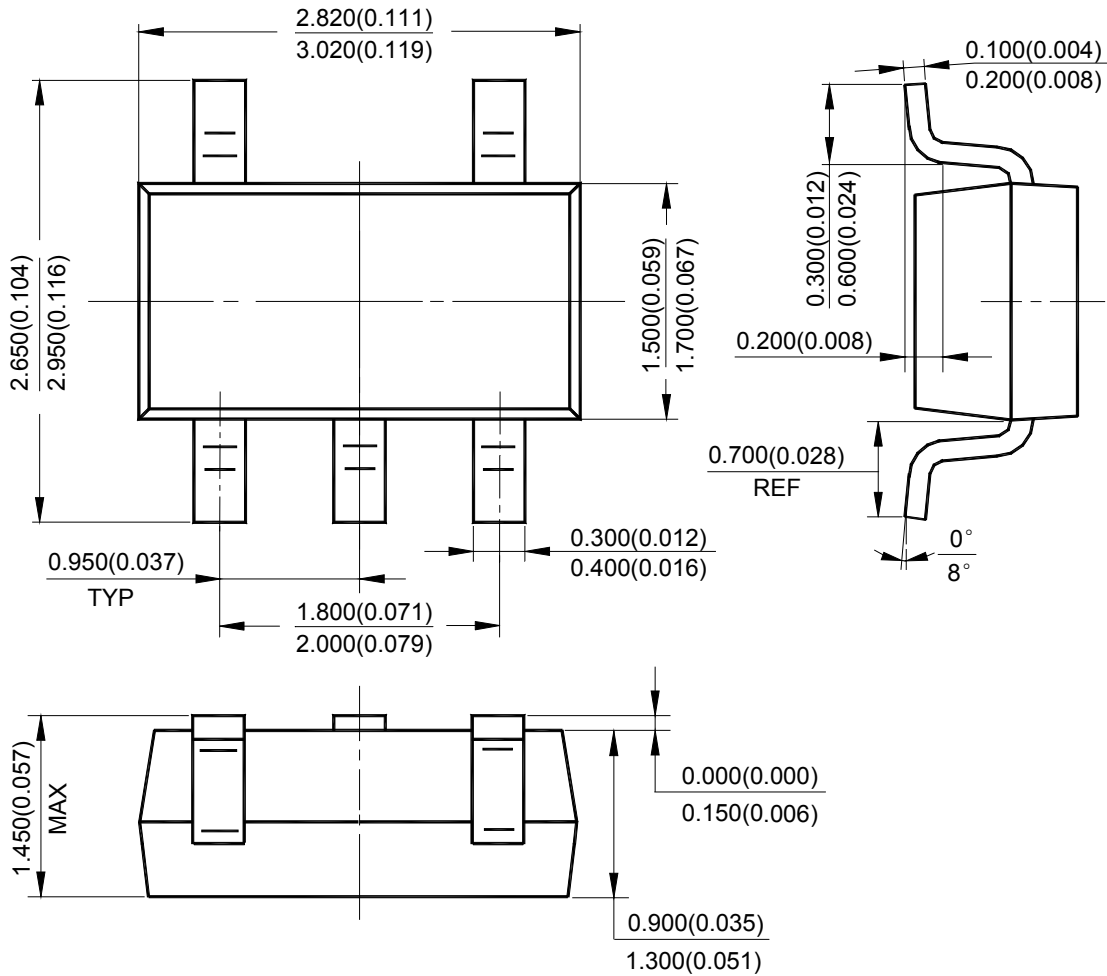





**Single/Dual Low Bias Current, Low Voltage, Rail-to-Rail  
Input/Output CMOS Operational Amplifiers**

**AZV831/2**

**Mechanical Dimensions (Continued)**

**SOIC-8**

**Unit: mm(inch)**

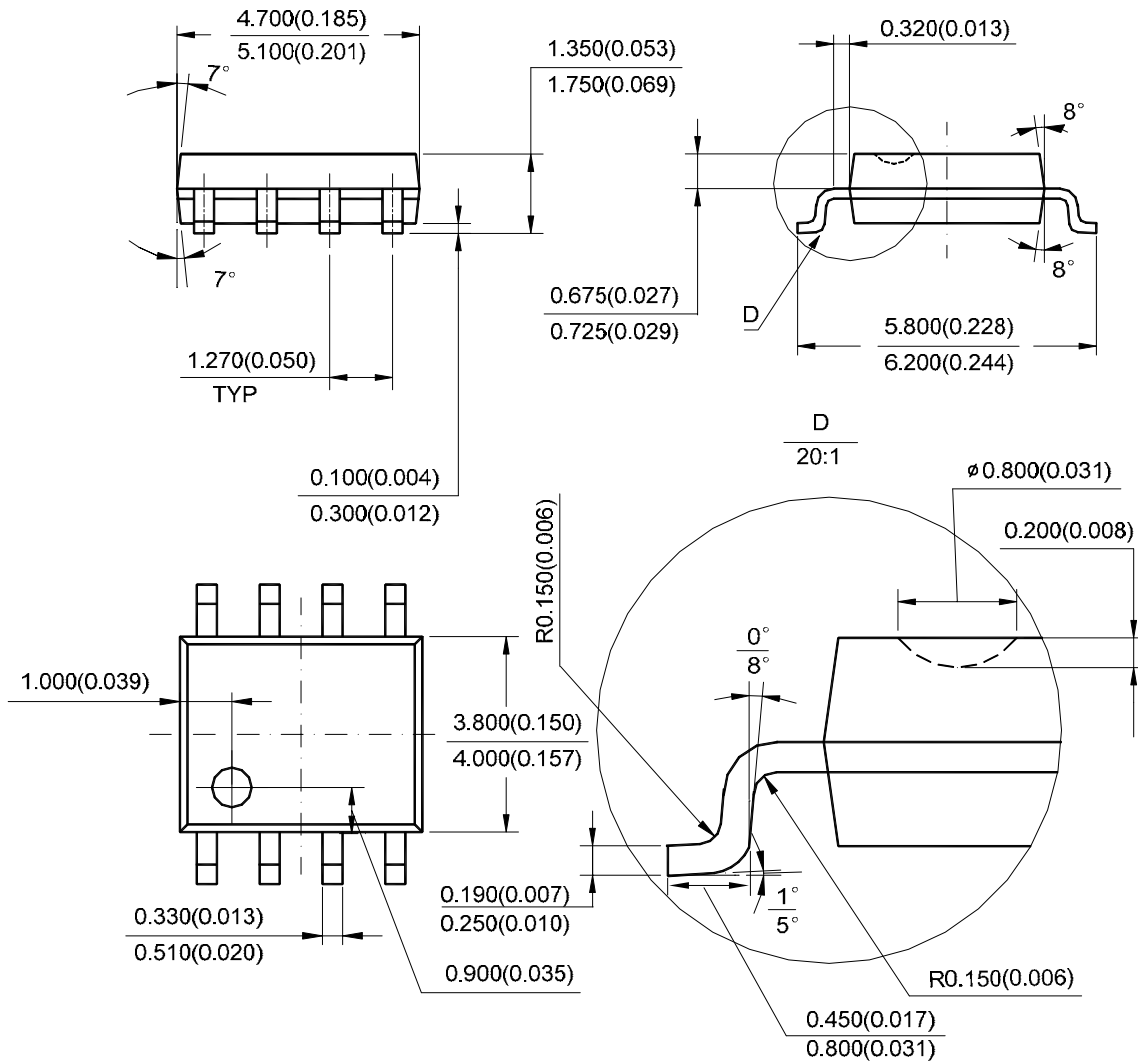

Note: Eject hole, oriented hole and mold mark is optional.

**Single/Dual Low Bias Current, Low Voltage, Rail-to-Rail  
Input/Output CMOS Operational Amplifiers**

**AZV831/2**

**Mechanical Dimensions (Continued)**

**MSOP-8**

**Unit: mm(inch)**

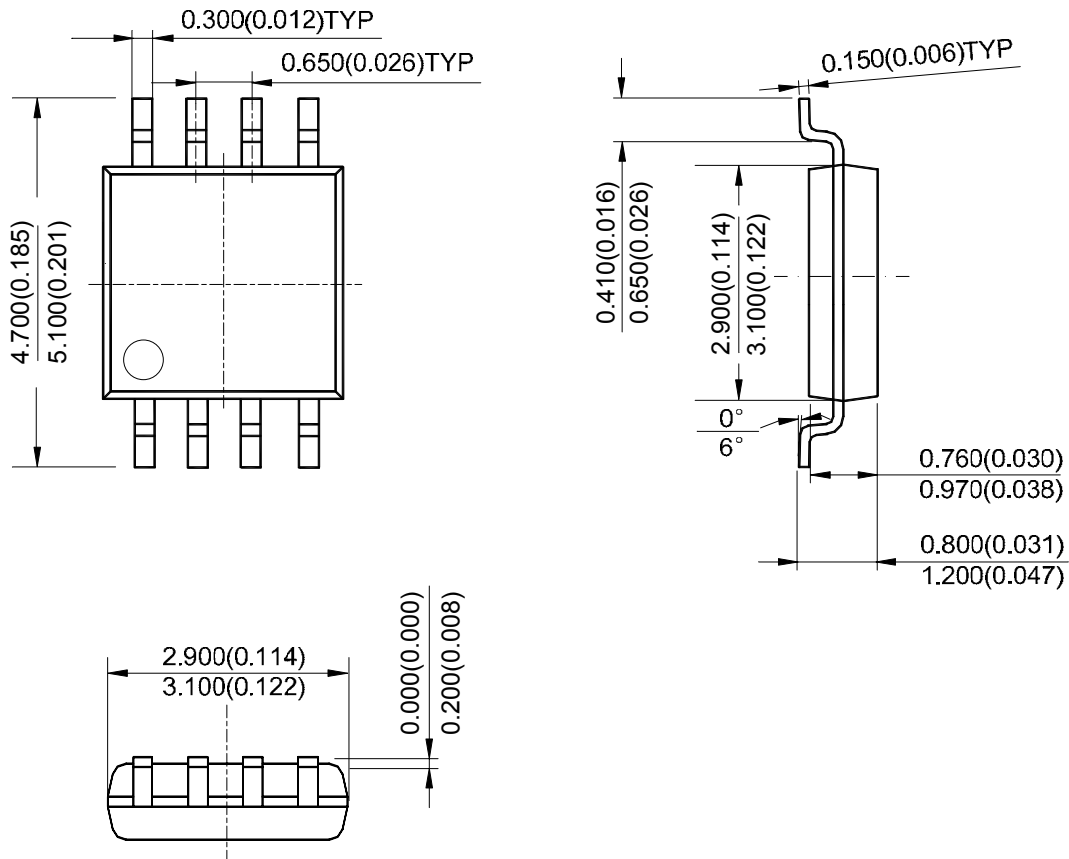

Note: Eject hole, oriented hole and mold mark is optional.



## **BCD Semiconductor Manufacturing Limited**

<http://www.bcdsemi.com>

### **IMPORTANT NOTICE**

BCD Semiconductor Manufacturing Limited reserves the right to make changes without further notice to any products or specifications herein. BCD Semiconductor Manufacturing Limited does not assume any responsibility for use of any its products for any particular purpose, nor does BCD Semiconductor Manufacturing Limited assume any liability arising out of the application or use of any its products or circuits. BCD Semiconductor Manufacturing Limited does not convey any license under its patent rights or other rights nor the rights of others.

---

#### **MAIN SITE**

##### **- Headquarters**

##### **BCD Semiconductor Manufacturing Limited**

No. 1600, Zi Xing Road, Shanghai ZiZhu Science-based Industrial Park, 200241, China  
Tel: +86-21-24162266, Fax: +86-21-24162277

##### **- Wafer Fab**

##### **Shanghai SIM-BCD Semiconductor Manufacturing Co., Ltd.**

800 Yi Shan Road, Shanghai 200233, China  
Tel: +86-21-6485 1491, Fax: +86-21-5450 0008

#### **REGIONAL SALES OFFICE**

##### **Shenzhen Office**

##### **Shanghai SIM-BCD Semiconductor Manufacturing Co., Ltd., Shenzhen Office**

Unit A Room 1203, Skyworth Bldg., Gaoxin Ave. 1.S., Nanshan District, Shenzhen, China  
Tel: +86-755-8826 7951  
Fax: +86-755-8826 7865

##### **Taiwan Office**

##### **BCD Semiconductor (Taiwan) Company Limited**

4F, 298-1, Rui Guang Road, Nei-Hu District, Taipei, Taiwan  
Tel: +886-2-2656 2808  
Fax: +886-2-2656 2806

##### **USA Office**

##### **BCD Semiconductor Corp.**

30920 Huntwood Ave. Hayward, CA 94544, USA  
Tel : +1-510-324-2988  
Fax: +1-510-324-2788



Компания «ЭлектроПласт» предлагает заключение долгосрочных отношений при поставках импортных электронных компонентов на взаимовыгодных условиях!

Наши преимущества:

- Оперативные поставки широкого спектра электронных компонентов отечественного и импортного производства напрямую от производителей и с крупнейших мировых складов;
- Поставка более 17-ти миллионов наименований электронных компонентов;
- Поставка сложных, дефицитных, либо снятых с производства позиций;
- Оперативные сроки поставки под заказ (от 5 рабочих дней);
- Экспресс доставка в любую точку России;
- Техническая поддержка проекта, помощь в подборе аналогов, поставка прототипов;
- Система менеджмента качества сертифицирована по Международному стандарту ISO 9001;
- Лицензия ФСБ на осуществление работ с использованием сведений, составляющих государственную тайну;
- Поставка специализированных компонентов (Xilinx, Altera, Analog Devices, Intersil, Interpoint, Microsemi, Aeroflex, Peregrine, Syfer, Eurofarad, Texas Instrument, Miteq, Cobham, E2V, MA-COM, Hittite, Mini-Circuits, General Dynamics и др.);

Помимо этого, одним из направлений компании «ЭлектроПласт» является направление «Источники питания». Мы предлагаем Вам помощь Конструкторского отдела:

- Подбор оптимального решения, техническое обоснование при выборе компонента;
- Подбор аналогов;
- Консультации по применению компонента;
- Поставка образцов и прототипов;
- Техническая поддержка проекта;
- Защита от снятия компонента с производства.



#### Как с нами связаться

**Телефон:** 8 (812) 309 58 32 (многоканальный)

**Факс:** 8 (812) 320-02-42

**Электронная почта:** [org@eplast1.ru](mailto:org@eplast1.ru)

**Адрес:** 198099, г. Санкт-Петербург, ул. Калинина, дом 2, корпус 4, литера А.