

# E3Z-LS

## Reliable Detection of Glossy, Uneven Objects Regardless of Background or Color.

- Switching between background and foreground suppression (BGS/ FGS) enables detecting a variety of objects under various background/foreground conditions.
- Unique algorithm minimizes external interference from inverter fluorescent lighting.
- Minimal differential travel to enable detecting small steps.
- Provides a high degree of protection (IP67), mutual interference prevention, and EN standard compliance.



Be sure to read *Safety Precautions* on page 8.

## Ordering Information

**Sensors** (Refer to *Dimensions* on page 10.)

Red light

Sensing method	Appearance	Connection method	Sensing distance (white paper)	Model	
				NPN output	PNP output
Distance-settable		Pre-wired (2 m) *1	<p>20 mm 40 mm 200 mm                      BGS (at min. setting) BGS (at max. setting) Incident light level threshold (fixed)                      FGS (at min. setting) FGS (at max. setting)</p>	E3Z-LS61 2M *2	E3Z-LS81 2M
		Connector (M8, 4 pins)		E3Z-LS66	E3Z-LS86
		Pre-wired (2 m) *1	<p>2 mm 20 mm 80 mm                      BGS (at min. setting) BGS (at max. setting)</p>	E3Z-LS63 2M	E3Z-LS83 2M
		Connector (M8, 4 pins)		E3Z-LS68	E3Z-LS88

\*1. Models with a 0.5-m cable are available. When ordering, specify the cable length by adding the code "0.5M" to the model number (e.g., E3Z-LS61 0.5M).  
 \*2. The following table shows the model numbers of e-CON Pre-wired Connectors that are available. The Ratings and Specifications are the same as those for the E3Z-LS61.

Cable length	Model
0.3 m	E3Z-LS61-ECON 0.3M
0.5 m	E3Z-LS61-ECON 0.5M
2 m	E3Z-LS61-ECON 2M

## Accessories (Order Separately)

### Mounting Brackets

### Sensor I/O Connectors (Refer to *Dimensions* on XS3)

Cable specification	Appearance	Type of cable	Model
Standard M8 cable		2 m	XS3F-M421-402-A
		5 m	XS3F-M421-405-A
		2 m	XS3F-M422-402-A
		5 m	XS3F-M422-405-A

## Ratings and Specifications

Sensing method		Distance-settable			
Model	NPN output	E3Z-LS61	E3Z-LS66	E3Z-LS63	E3Z-LS68
Item	PNP output	E3Z-LS81	E3Z-LS86	E3Z-LS83	E3Z-LS88
Sensing distance	BGS	White or black paper (100 × 100 mm): 20 mm to set distance		2 mm to set distance (80 mm max.)	
	FGS	White paper (100 × 100 mm): Set distance to 200 mm min. Black paper (100 × 100 mm): Set distance to 160 mm min.		-----	
Setting range		White paper (100 × 100 mm): 40 to 200 mm Black paper (100 × 100 mm): 40 to 160 mm		White paper (100 × 100 mm): 20 to 80 mm	
Differential travel		10% of set distance max. (Refer to <i>Differential Travel vs. Sensing Distance</i> on page 4.)		2% of set distance max.	
Reflectivity characteristic (black/white error)		10% of set distance max.		5% of set distance max.	
Light source (wavelength)		Red LED (680 nm)		Red LED (650 nm)	
Power supply voltage		12 to 24 VDC ±10%, ripple (p-p): 10% max.			
Current consumption		30 mA max.			
Control output		Load power supply voltage: 26.4 VDC max., Load current: 100 mA max. (residual voltage 1 V max.), Open collector output (NPN or PNP depending on model) Light-ON/Dark-ON switch selectable			
BGS/FGS selection		BGS: Open or connected to GND FGS: Connected to Vcc		BGS: Open or connected to GND	
Protection circuits		Reversed power supply polarity protection, Output short-circuit protection, Mutual interference prevention			
Response time		Operate or reset: 1 ms max.			
Distance setting		5-turn endless adjuster			
Ambient illumination (Receiver side)		Incandescent lamp: 3,000 lx max.; Sunlight: 10,000 lx max.			
Ambient temperature range		Operating: -25 to 55°C, Storage: -40 to 70°C (with no icing or condensation)			
Ambient humidity range		Operating: 35% to 85%, Storage: 35% to 95% (with no condensation)			
Insulation resistance		20 MΩ min. at 500 VDC			
Dielectric strength		1,000 VAC at 50/60 Hz for 1 minute			
Vibration resistance		Destruction: 10 to 55 Hz, 1.5-mm double amplitude for 2 hours each in X, Y, and Z directions			
Shock resistance		Destruction: 500 m/s <sup>2</sup> for 3 times each in X, Y, and Z directions			
Degree of protection		IP67 (IEC 60529)			
Connection method		Pre-wired (standard lengths: 2 m and 0.5 m)	Connector (M8, 4 pins)	Pre-wired (standard lengths: 2 m and 0.5 m)	Connector (M8, 4 pins)
Indicators		Operation indicator (orange), Stability indicator (green)			
Weight (packed state)		Pre-wired Sensors, 2 m: Approx. 65 g	Approx. 20 g	Pre-wired Sensors, 2 m: Approx. 65 g	Approx. 20 g
Material	Case	PBT (polybutylene terephthalate)			
	Lens	Modified polyarylate resin			
Accessories		Instruction manual (Mounting Brackets must be ordered separately.)			

Engineering Data

Operating Range

E3Z-LS□1/LS□6  
BGS

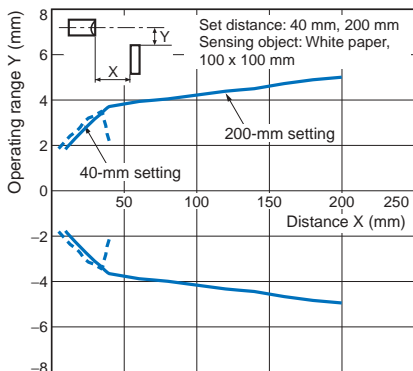

FGS

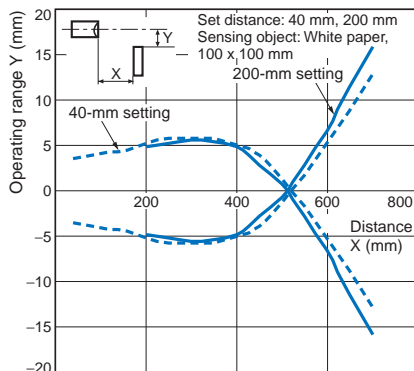

E3Z-LS□3/LS□8

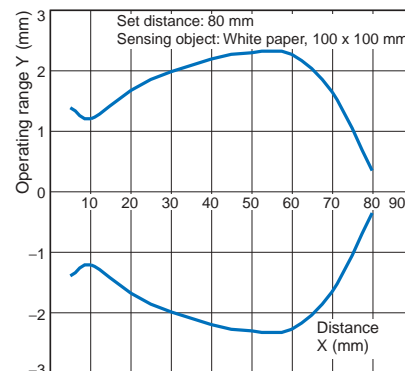

Spot Diameter vs. Sensing Distance

E3Z-LS□1/LS□6

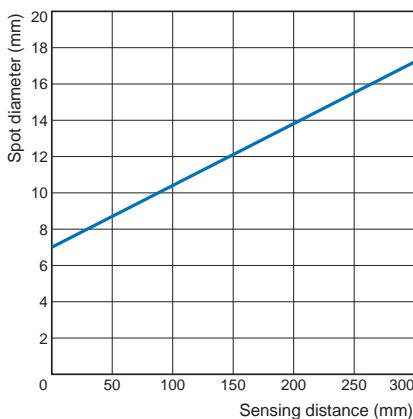

E3Z-LS□3/LS□8

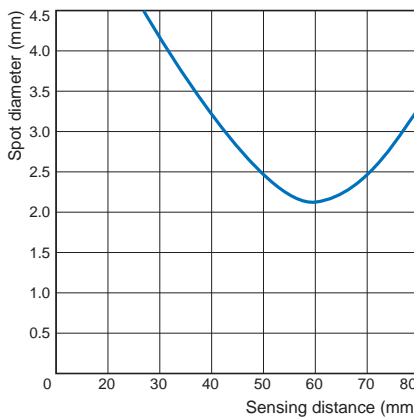

Close-range Characteristics

E3Z-LS□1/LS□6

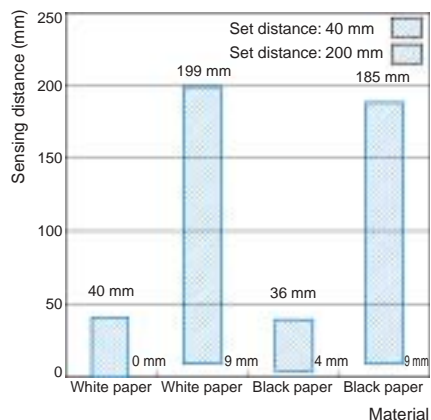

E3Z-LS□3/LS□8

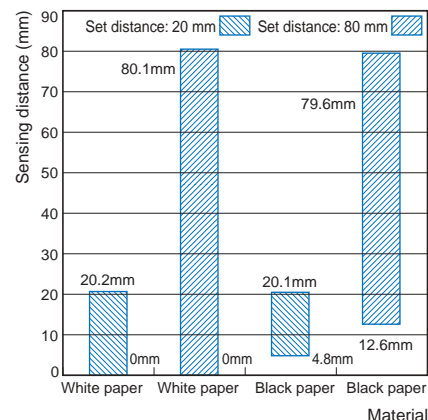

Differential Travel vs. Sensing Distance

E3Z-LS□1/LS□6

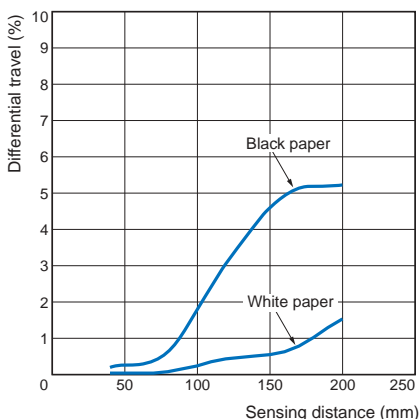

E3Z-LS□3/LS□8

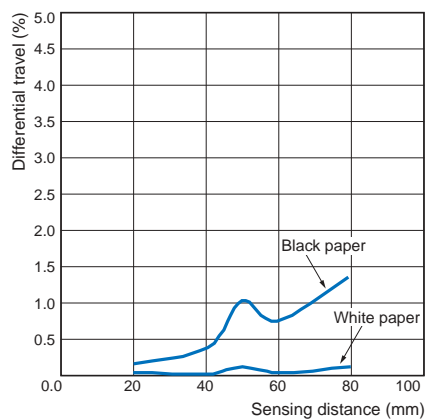

Sensing Object Angle Characteristics

E3Z-LS□1/LS□6

Vertical

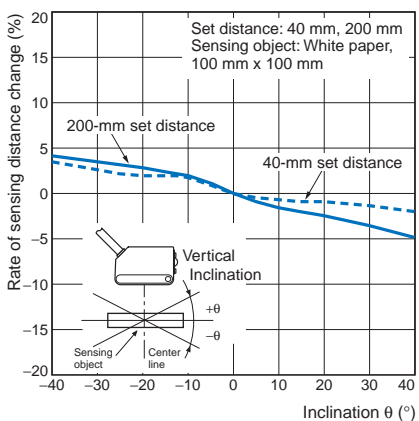

Horizontal

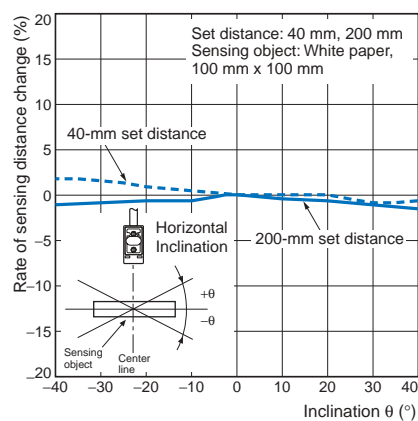

E3Z-LS□3/LS□8

Vertical

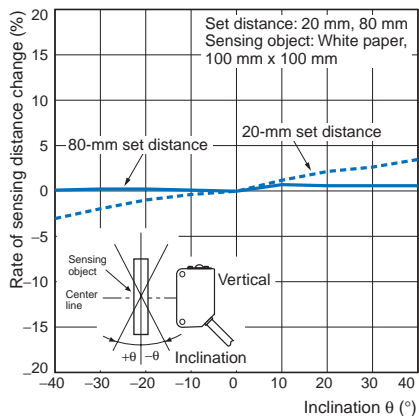

Horizontal

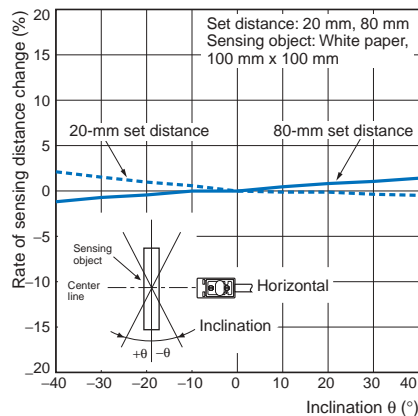

## FGS Mode Set Distance

E3Z-LS□1/LS□6

White Paper

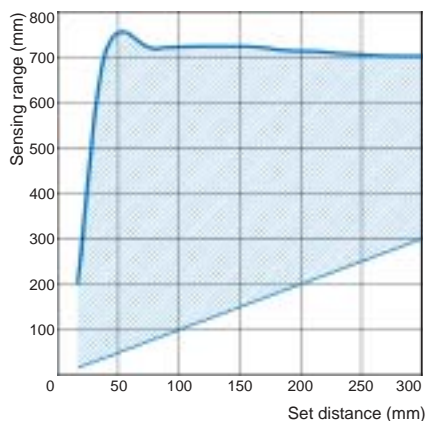

Black Paper

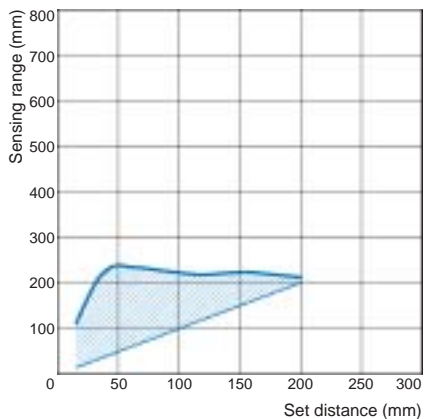

## Sensing Distance vs. Sensing Object Material

E3Z-LS□1/LS□6

Set Distance of 40 mm using White Paper

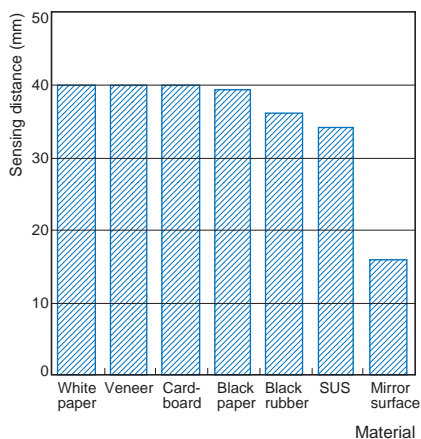

Set Distance of 200 mm using White Paper

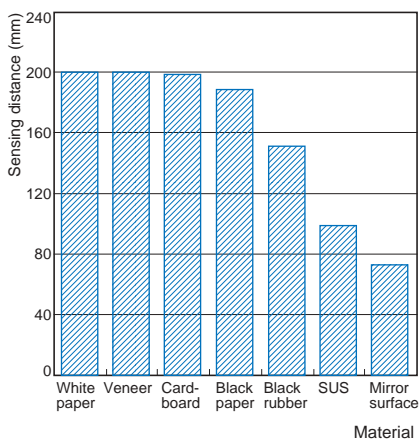

E3Z-LS□3/LS□8

Set Distance of 20 mm using White Paper

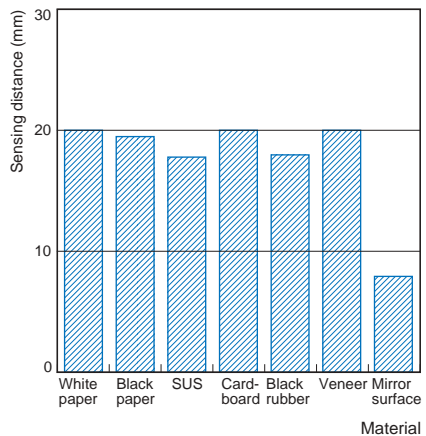

Set Distance of 80 mm using White Paper

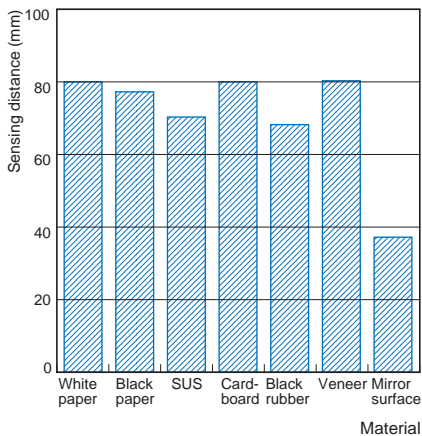

# I/O Circuit Diagrams



Note: The VERY FAR region is supported only for FGS.  
The incident light level threshold is fixed and cannot be set.

## NPN Output

Model	Operation mode	Timing charts	Operation selector	BGS/FGS selection method	Output circuit
E3Z-LS61 E3Z-LS66 E3Z-LS63 E3Z-LS68	Light-ON		L side (LIGHT ON)	BGS: Either leave the pink wire (2) open or connect it to the blue wire (3).	
	Dark-ON		D side (DARK ON)		
E3Z-LS61 E3Z-LS66	Light-ON		L side (LIGHT ON)	FGS: Connect the pink wire (2) to the brown wire (1).	
	Dark-ON		D side (DARK ON)		

Connector Pin Arrangement



e-CON Connector Pin Arrangement

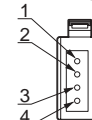

## PNP Output

Model	Operation mode	Timing charts	Operation selector	BGS/FGS selection method	Output circuit
E3Z-LS81 E3Z-LS86 E3Z-LS83 E3Z-LS88	Light-ON		L side (LIGHT ON)	BGS: Either leave the pink wire (2) open or connect it to the blue wire (3).	<p>Connector Pin Arrangement</p>
	Dark-ON		D side (DARK ON)		
E3Z-LS81 E3Z-LS86	Light-ON		L side (LIGHT ON)	FGS: Connect the pink wire (2) to the brown wire (1).	
	Dark-ON		D side (DARK ON)		

## Plugs (Sensor I/O Connectors)

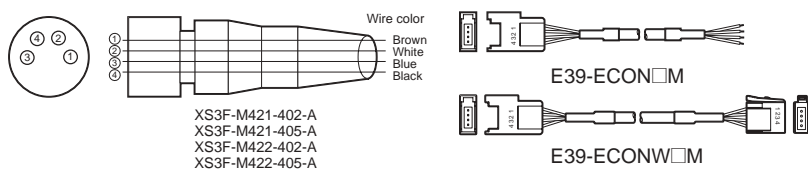

Classification	Wire color	Connector pin No.	Application
DC	Brown	1	Power supply (+V)
	White	2	BGS/FGS selection
	Blue	3	Power supply (0 V)
	Black	4	Output

## Nomenclature

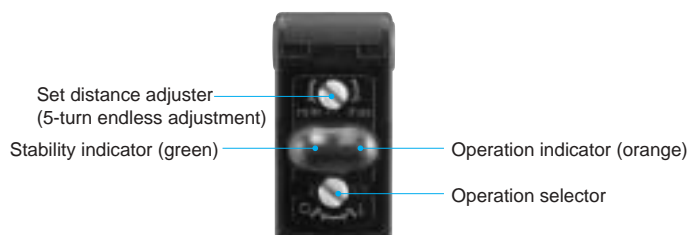

## Safety Precautions

Refer to *Safety Precautions of the E3Z and Warranty and Limitations of Liability*.

### ⚠ WARNING

This product is not designed or rated for ensuring safety of persons either directly or indirectly. Do not use it for such purposes.



### ⚠ Caution

Do not connect an AC power supply to the Sensor. If AC power (100 VAC or more) is supplied to the Sensor, it may explode or burn.



### Precautions for Safe Use

Be sure to abide by the following precautions for the safe operation of the Sensor.

#### ● Wiring

##### Power Supply Voltage and Output Load Power Supply Voltage

Make sure that the power supply to the Sensor is within the rated voltage range. If a voltage exceeding the rated voltage range is supplied to the Sensor, it may explode or burn.

##### Load Short-circuiting

Do not short-circuit the load, otherwise the Sensor may be damaged.

##### Connection without Load

Do not connect the power supply to the Sensor with no load connected, otherwise the internal elements may explode or burn.

#### ● Operating Environment

Do not use the Sensor in locations with explosive or flammable gas.

### Precautions for Correct Use

Do not use the product in atmospheres or environments that exceed product ratings.

#### ● Designing

##### Power Reset Time

The Sensor is ready to operate 100 ms after the Sensor is turned ON. If the load and Sensor are connected to independent power supplies respectively, be sure to turn ON the Sensor before supplying power to the load.

#### ● Wiring

##### Avoiding Malfunctions

If using the Sensor with an inverter or servomotor, always ground the FG (frame ground) and G (ground) terminals, otherwise the Sensor may malfunction.

#### ● Mounting

##### Mounting the Sensor

- If Sensors are mounted face-to-face, make sure that the optical axes are not in opposition to each other. Otherwise, mutual interference may result.
- Always install the Sensor carefully so that the aperture angle range of the Sensor will not cause it to be directly exposed to intensive light, such as sunlight, fluorescent light, or incandescent light.
- Do not strike the Photoelectric Sensor with a hammer or any other tool during the installation of the Sensor, or the Sensor will lose its water-resistive properties.
- Use M3 screws to mount the Sensor.
- When mounting the case, make sure that the tightening torque applied to each screw does not exceed 0.54 N·m.

##### M8 Connector

- Always turn OFF the power supply to the Sensor before connecting or disconnecting the metal connector.
  - Hold the connector cover to connect or disconnect it. If the XS3F is used, always tighten the connector cover by hand. Do not use pliers.
- If the connector is not connected securely, it may be disconnected by vibration or the proper degree of protection of the Sensor may not be maintained. The appropriate tightening torque is 0.3 to 0.4 N·m.
- If other commercially available connectors are used, follow the recommended connector application conditions and recommended tightening torque specifications.

##### Mounting Directions

- Make sure that the sensing side of the Sensor is parallel with the surface of the sensing objects. Normally, do not incline the Sensor towards the sensing object.

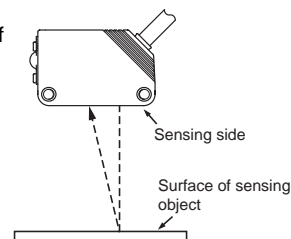

If the sensing object has a glossy surface, however, incline the Sensor by 5° to 10° as shown in the illustration, provided that the Sensor is not influenced by background objects.

- If there is a mirror-like object below the Sensor, the Sensor may not operate stably. Therefore, incline the Sensor or separate the Sensor from the mirror-like object as shown below.

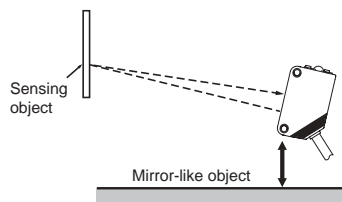
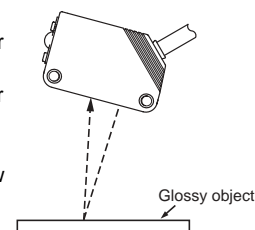



• Do not install the Sensor in the wrong direction. Refer to the following illustration.

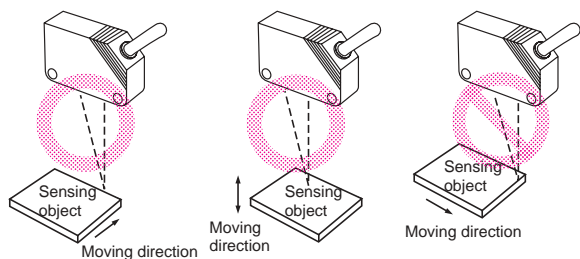

Install the Sensor as shown in the following illustration if each sensing object greatly differs in color or material.

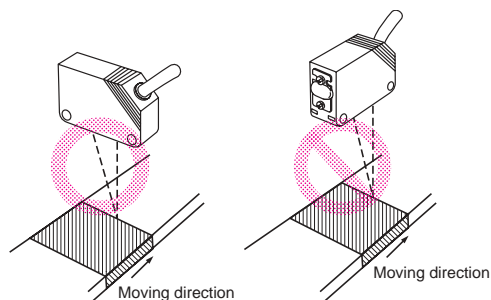

### ● Adjusting Indicator Operation

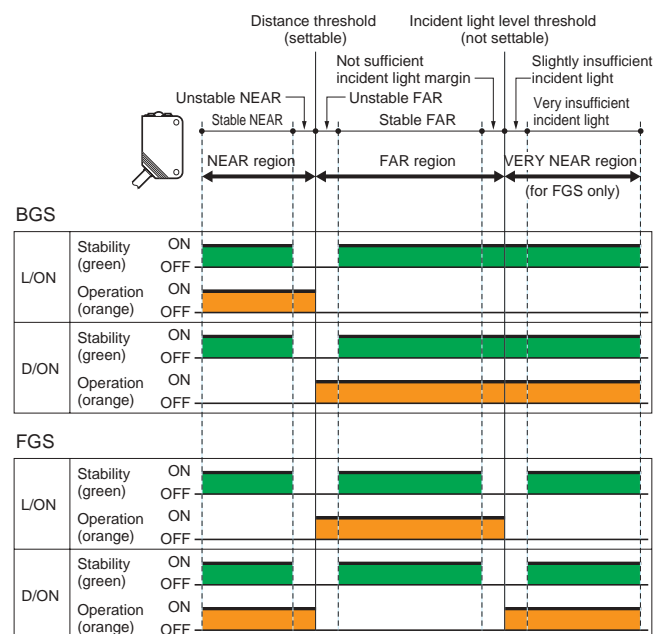

Note: 1. If the stability indicator is lit, the detection/no detection status is stable within the rated ambient operating temperature (-25 to 55°C).  
 2. The VERY FAR region is supported only for FGS. The incident light threshold is fixed and cannot be set. The distance to the incident light threshold depends on the color and gloss of the sensing object's surface.

### ● Inspection and Maintenance

#### Cleaning

Never use paint thinners or other organic solvents to clean the surface of the product.

## Dimensions

### Pre-wired Models

- E3Z-LS61
- E3Z-LS81
- E3Z-LS63
- E3Z-LS83

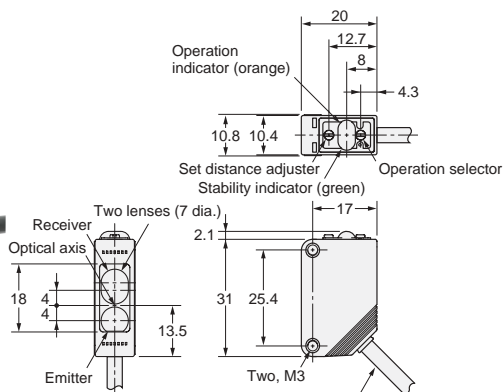

4-dia., vinyl-insulated round cable with 4 conductors (Conductor cross section: 0.2 mm<sup>2</sup> (AWG24); Insulator diameter: 1.1 mm), Standard length: 2 m/0.5 m

### e-CON Pre-wired Connector

Connector: Model No. 37104-3122-000FL  
Sumitomo 3M

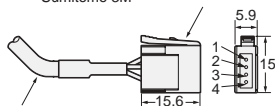

\* 4-dia. vinyl-insulated round cable with 4 conductors  
Standard lengths: 0.3 m, 0.5 m, and 2 m

### Connector Models

- E3Z-LS66
- E3Z-LS86
- E3Z-LS68
- E3Z-LS88

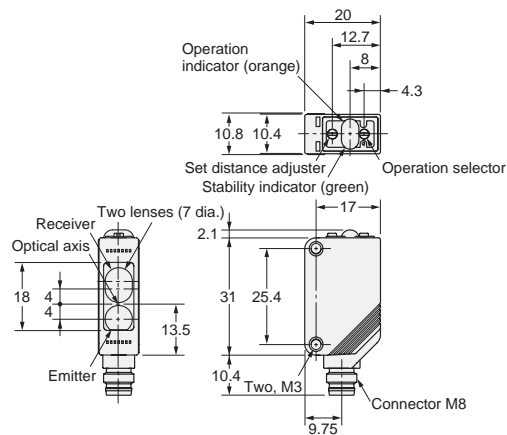

## Read and Understand This Catalog

Please read and understand this catalog before purchasing the products. Please consult your OMRON representative if you have any questions or comments.

## Warranty and Limitations of Liability

### WARRANTY

OMRON's exclusive warranty is that the products are free from defects in materials and workmanship for a period of one year (or other period if specified) from date of sale by OMRON.

OMRON MAKES NO WARRANTY OR REPRESENTATION, EXPRESS OR IMPLIED, REGARDING NON-INFRINGEMENT, MERCHANTABILITY, OR FITNESS FOR PARTICULAR PURPOSE OF THE PRODUCTS. ANY BUYER OR USER ACKNOWLEDGES THAT THE BUYER OR USER ALONE HAS DETERMINED THAT THE PRODUCTS WILL SUITABLY MEET THE REQUIREMENTS OF THEIR INTENDED USE. OMRON DISCLAIMS ALL OTHER WARRANTIES, EXPRESS OR IMPLIED.

### LIMITATIONS OF LIABILITY

OMRON SHALL NOT BE RESPONSIBLE FOR SPECIAL, INDIRECT, OR CONSEQUENTIAL DAMAGES, LOSS OF PROFITS OR COMMERCIAL LOSS IN ANY WAY CONNECTED WITH THE PRODUCTS, WHETHER SUCH CLAIM IS BASED ON CONTRACT, WARRANTY, NEGLIGENCE, OR STRICT LIABILITY.

In no event shall the responsibility of OMRON for any act exceed the individual price of the product on which liability is asserted.

IN NO EVENT SHALL OMRON BE RESPONSIBLE FOR WARRANTY, REPAIR, OR OTHER CLAIMS REGARDING THE PRODUCTS UNLESS OMRON'S ANALYSIS CONFIRMS THAT THE PRODUCTS WERE PROPERLY HANDLED, STORED, INSTALLED, AND MAINTAINED AND NOT SUBJECT TO CONTAMINATION, ABUSE, MISUSE, OR INAPPROPRIATE MODIFICATION OR REPAIR.

## Application Considerations

### SUITABILITY FOR USE

OMRON shall not be responsible for conformity with any standards, codes, or regulations that apply to the combination of products in the customer's application or use of the products.

At the customer's request, OMRON will provide applicable third party certification documents identifying ratings and limitations of use that apply to the products. This information by itself is not sufficient for a complete determination of the suitability of the products in combination with the end product, machine, system, or other application or use.

The following are some examples of applications for which particular attention must be given. This is not intended to be an exhaustive list of all possible uses of the products, nor is it intended to imply that the uses listed may be suitable for the products:

- Outdoor use, uses involving potential chemical contamination or electrical interference, or conditions or uses not described in this catalog.
- Nuclear energy control systems, combustion systems, railroad systems, aviation systems, medical equipment, amusement machines, vehicles, safety equipment, and installations subject to separate industry or government regulations.
- Systems, machines, and equipment that could present a risk to life or property.

Please know and observe all prohibitions of use applicable to the products.

NEVER USE THE PRODUCTS FOR AN APPLICATION INVOLVING SERIOUS RISK TO LIFE OR PROPERTY WITHOUT ENSURING THAT THE SYSTEM AS A WHOLE HAS BEEN DESIGNED TO ADDRESS THE RISKS, AND THAT THE OMRON PRODUCTS ARE PROPERLY RATED AND INSTALLED FOR THE INTENDED USE WITHIN THE OVERALL EQUIPMENT OR SYSTEM.

### PROGRAMMABLE PRODUCTS

OMRON shall not be responsible for the user's programming of a programmable product, or any consequence thereof.

## Disclaimers

### CHANGE IN SPECIFICATIONS

Product specifications and accessories may be changed at any time based on improvements and other reasons.

It is our practice to change model numbers when published ratings or features are changed, or when significant construction changes are made. However, some specifications of the products may be changed without any notice. When in doubt, special model numbers may be assigned to fix or establish key specifications for your application on your request. Please consult with your OMRON representative at any time to confirm actual specifications of purchased products.

### DIMENSIONS AND WEIGHTS

Dimensions and weights are nominal and are not to be used for manufacturing purposes, even when tolerances are shown.

### PERFORMANCE DATA

Performance data given in this catalog is provided as a guide for the user in determining suitability and does not constitute a warranty. It may represent the result of OMRON's test conditions, and the users must correlate it to actual application requirements. Actual performance is subject to the OMRON Warranty and Limitations of Liability.

### ERRORS AND OMISSIONS

The information in this document has been carefully checked and is believed to be accurate; however, no responsibility is assumed for clerical, typographical, or proofreading errors, or omissions.

2008.11

In the interest of product improvement, specifications are subject to change without notice.

**OMRON Corporation**  
Industrial Automation Company

<http://www.ia.omron.com/>

(c)Copyright OMRON Corporation 2008 All Right Reserved.



Компания «ЭлектроПласт» предлагает заключение долгосрочных отношений при поставках импортных электронных компонентов на взаимовыгодных условиях!

Наши преимущества:

- Оперативные поставки широкого спектра электронных компонентов отечественного и импортного производства напрямую от производителей и с крупнейших мировых складов;
- Поставка более 17-ти миллионов наименований электронных компонентов;
- Поставка сложных, дефицитных, либо снятых с производства позиций;
- Оперативные сроки поставки под заказ (от 5 рабочих дней);
- Экспресс доставка в любую точку России;
- Техническая поддержка проекта, помощь в подборе аналогов, поставка прототипов;
- Система менеджмента качества сертифицирована по Международному стандарту ISO 9001;
- Лицензия ФСБ на осуществление работ с использованием сведений, составляющих государственную тайну;
- Поставка специализированных компонентов (Xilinx, Altera, Analog Devices, Intersil, Interpoint, Microsemi, Aeroflex, Peregrine, Syfer, Eurofarad, Texas Instrument, Miteq, Cobham, E2V, MA-COM, Hittite, Mini-Circuits, General Dynamics и др.);

Помимо этого, одним из направлений компании «ЭлектроПласт» является направление «Источники питания». Мы предлагаем Вам помощь Конструкторского отдела:

- Подбор оптимального решения, техническое обоснование при выборе компонента;
- Подбор аналогов;
- Консультации по применению компонента;
- Поставка образцов и прототипов;
- Техническая поддержка проекта;
- Защита от снятия компонента с производства.



#### Как с нами связаться

**Телефон:** 8 (812) 309 58 32 (многоканальный)

**Факс:** 8 (812) 320-02-42

**Электронная почта:** [org@eplast1.ru](mailto:org@eplast1.ru)

**Адрес:** 198099, г. Санкт-Петербург, ул. Калинина, дом 2, корпус 4, литера А.