

The S-8254A Series is a protection IC for 3-serial- or 4-serial-cell lithium-ion / lithium polymer rechargeable batteries and includes a high-accuracy voltage detector and delay circuit.

The S-8254A Series protects both 3-serial or 4-serial cells using the SEL pin for switching.

## ■ Features

- (1) High-accuracy voltage detection for each cell
 

• Overcharge detection voltage n (n = 1 to 4)	3.90 V to 4.45 V (50 mV step)	Accuracy ±25 mV
• Overcharge release voltage n (n = 1 to 4)	3.80 V to 4.45 V <sup>*1</sup>	Accuracy ±50 mV
• Overdischarge detection voltage n (n = 1 to 4)	2.0 V to 3.0 V (100 mV step)	Accuracy ±80 mV
• Overdischarge release voltage n (n = 1 to 4)	2.0 V to 3.4 V <sup>*2</sup>	Accuracy ±100 mV
- (2) Three-level overcurrent protection
 

• Overcurrent detection voltage 1	0.05 V to 0.30 V (50 mV step)	Accuracy ±25 mV
• Overcurrent detection voltage 2	0.5 V	Accuracy ±100 mV
• Overcurrent detection voltage 3	$V_{VC1} - 1.2 V$	Accuracy ±300 mV
- (3) Delay times for overcharge detection, overdischarge detection and overcurrent detection 1 can be set by external capacitors (delay times for overcurrent detection 2 and 3 are fixed internally).
- (4) Switchable between a 3-serial cell and 4-serial cell using the SEL pin
- (5) Charge/discharge operation can be controlled via the control pins.
- (6) 0 V battery charge Enabled, inhibited
- (7) Power-down function Available
- (8) High-withstand voltage Absolute maximum rating : 26 V
- (9) Wide operating voltage range 2 V to 24 V
- (10) Wide operating temperature range -40°C to + 85°C
- (11) Low current consumption
 

• During operation	30 μA max. (+25°C)
• During power-down	0.1 μA max. (+25°C)
- (12) Lead-free, Sn100%, halogen-free<sup>\*3</sup>

\*1. Overcharge hysteresis voltage n (n = 1 to 4) can be selected as 0 V or from a range of 0.1 V to 0.4 V in 50 mV steps.

(Overcharge hysteresis voltage = Overcharge detection voltage – Overcharge release voltage)

\*2. Overdischarge hysteresis voltage n (n = 1 to 4) can be selected as 0 V or from a range of 0.2 V to 0.7 V in 100 mV steps.

(Overdischarge hysteresis voltage = Overdischarge release voltage – Overdischarge detection voltage)

\*3. Refer to “■ Product Name Structure” for details.

## ■ Applications

- Lithium-ion rechargeable battery packs
- Lithium polymer rechargeable battery packs

## ■ Package

- 16-Pin TSSOP

■ **Block Diagram**



- Remark**
1. Diodes in the figure are parasitic diodes.
  2. Numerical values are typical values.

**Figure 1**

■ **Product Name Structure**

1. **Product Name**



\*1. Refer to the tape drawing.

\*2. Refer to "3. Product Name List".

2. **Package**

Package name	Package	Tape	Reel	
16-Pin TSSOP	Environmental code = G, S	FT016-A-P-SD	FT016-A-C-SD	FT016-A-R-SD
	Environmental code = U	FT016-A-P-SD	FT016-A-C-SD	FT016-A-R-S1

**3. Product Name List**

**Table 1**

Product name / Item	Overcharge detection voltage [V <sub>CU</sub> ]	Overcharge release voltage [V <sub>CL</sub> ]	Overdischarge detection voltage [V <sub>DL</sub> ]	Overdischarge release voltage [V <sub>DU</sub> ]	Overcurrent detection voltage 1 [V <sub>IOV1</sub> ]	0 V battery charge
S-8254AAAFT-TB-x	4.350 ± 0.025 V	4.150 ± 0.050 V	2.00 ± 0.080 V	2.70 ± 0.100 V	0.30 ± 0.025 V	Enabled
S-8254AABFT-TB-x	4.250 ± 0.025 V	4.250 ± 0.025 V	2.00 ± 0.080 V	2.70 ± 0.100 V	0.30 ± 0.025 V	Enabled
S-8254AAEFT-TB-x	4.350 ± 0.025 V	4.150 ± 0.050 V	2.00 ± 0.080 V	2.70 ± 0.100 V	0.20 ± 0.025 V	Enabled
S-8254AAFFT-TB-x	4.350 ± 0.025 V	4.150 ± 0.050 V	2.40 ± 0.080 V	3.00 ± 0.100 V	0.20 ± 0.025 V	Enabled
S-8254AAGFT-TB-x	4.275 ± 0.025 V	4.075 ± 0.050 V	2.30 ± 0.080 V	2.70 ± 0.100 V	0.13 ± 0.025 V	Enabled
S-8254AAHFT-TB-x	4.350 ± 0.025 V	4.150 ± 0.050 V	2.40 ± 0.080 V	2.70 ± 0.100 V	0.10 ± 0.025 V	Enabled
S-8254AAJFT-TB-x	4.350 ± 0.025 V	4.150 ± 0.050 V	2.40 ± 0.080 V	3.00 ± 0.100 V	0.15 ± 0.025 V	Enabled
S-8254AAKFT-TB-x	4.350 ± 0.025 V	4.150 ± 0.050 V	2.70 ± 0.080 V	3.00 ± 0.100 V	0.20 ± 0.025 V	Enabled
S-8254AALFT-TB-x	4.300 ± 0.025 V	4.150 ± 0.050 V	2.40 ± 0.080 V	3.00 ± 0.100 V	0.20 ± 0.025 V	Enabled
S-8254AAMFT-TB-x	4.200 ± 0.025 V	4.100 ± 0.050 V	2.50 ± 0.080 V	2.70 ± 0.100 V	0.30 ± 0.025 V	Enabled
S-8254AANFT-TB-x	4.250 ± 0.025 V	4.150 ± 0.050 V	2.50 ± 0.080 V	3.00 ± 0.100 V	0.10 ± 0.025 V	Enabled
S-8254AAOFT-TB-x	4.300 ± 0.025 V	4.080 ± 0.050 V	2.50 ± 0.080 V	3.00 ± 0.100 V	0.10 ± 0.025 V	Enabled
S-8254AAPFT-TB-x	4.280 ± 0.025 V	4.130 ± 0.050 V	3.00 ± 0.080 V	3.00 ± 0.080 V	0.15 ± 0.025 V	Enabled
S-8254AAQFT-TB-x	3.900 ± 0.025 V	3.800 ± 0.050 V	2.30 ± 0.080 V	2.70 ± 0.100 V	0.30 ± 0.025 V	Enabled
S-8254AARFT-TB-x	4.350 ± 0.025 V	4.150 ± 0.050 V	2.80 ± 0.080 V	3.00 ± 0.100 V	0.20 ± 0.025 V	Enabled
S-8254AASFT-TB-x	4.290 ± 0.025 V	4.090 ± 0.050 V	2.30 ± 0.080 V	3.00 ± 0.100 V	0.075 ± 0.025 V	Enabled
S-8254AATFT-TB-x	4.200 ± 0.025 V	4.200 ± 0.025 V	2.00 ± 0.080 V	2.70 ± 0.100 V	0.30 ± 0.025 V	Enabled
S-8254AAUFT-TB-x	4.350 ± 0.025 V	4.150 ± 0.050 V	2.40 ± 0.080 V	3.00 ± 0.100 V	0.20 ± 0.025 V	Inhibited
S-8254AAVFT-TB-x	4.250 ± 0.025 V	4.150 ± 0.050 V	2.70 ± 0.080 V	3.00 ± 0.100 V	0.20 ± 0.025 V	Enabled
S-8254AAWFT-TB-x	4.250 ± 0.025 V	4.100 ± 0.050 V	3.00 ± 0.080 V	3.20 ± 0.100 V	0.10 ± 0.025 V	Inhibited
S-8254AAYFT-TB-x	4.275 ± 0.025 V	4.125 ± 0.050 V	2.40 ± 0.080 V	2.70 ± 0.100 V	0.10 ± 0.025 V	Enabled
S-8254AAZFT-TB-x	4.250 ± 0.025 V	4.150 ± 0.050 V	2.00 ± 0.080 V	2.70 ± 0.100 V	0.13 ± 0.025 V	Enabled
S-8254ABAFT-TB-x	3.900 ± 0.025 V	3.800 ± 0.050 V	2.00 ± 0.080 V	2.50 ± 0.100 V	0.15 ± 0.025 V	Enabled
S-8254ABCFT-TB-x	4.175 ± 0.025 V	3.975 ± 0.050 V	2.75 ± 0.080 V	3.05 ± 0.100 V	0.10 ± 0.025 V	Enabled
S-8254ABDFT-TB-y	4.300 ± 0.025 V	4.100 ± 0.050 V	2.00 ± 0.080 V	2.00 ± 0.080 V	0.13 ± 0.025 V	Enabled
S-8254ABEFT-TB-y	4.200 ± 0.025 V	4.150 ± 0.050 V	2.50 ± 0.080 V	3.00 ± 0.100 V	0.15 ± 0.025 V	Enabled
S-8254ABFFT-TB-x	4.150 ± 0.025 V	4.050 ± 0.050 V	2.00 ± 0.080 V	2.70 ± 0.100 V	0.13 ± 0.025 V	Enabled
S-8254ABGFT-TB-x	4.180 ± 0.025 V	4.080 ± 0.050 V	2.00 ± 0.080 V	2.70 ± 0.100 V	0.13 ± 0.025 V	Enabled
S-8254ABHFT-TB-y	4.150 ± 0.025 V	4.050 ± 0.050 V	2.50 ± 0.080 V	2.80 ± 0.100 V	0.10 ± 0.025 V	Enabled
S-8254ABIFT-TB-x	4.215 ± 0.025 V	4.115 ± 0.050 V	2.40 ± 0.080 V	3.00 ± 0.100 V	0.20 ± 0.025 V	Inhibited
S-8254ABJFT-TB-U	4.225 ± 0.025 V	4.125 ± 0.050 V	2.50 ± 0.080 V	2.70 ± 0.100 V	0.10 ± 0.025 V	Enabled
S-8254ABKFT-TB-U	4.150 ± 0.025 V	4.150 ± 0.025 V	2.00 ± 0.080 V	2.70 ± 0.100 V	0.30 ± 0.025 V	Enabled
S-8254ABLFT-TB-U	4.250 ± 0.025 V	4.100 ± 0.050 V	2.40 ± 0.080 V	3.00 ± 0.100 V	0.20 ± 0.025 V	Inhibited
S-8254ABMFT-TB-U	4.425 ± 0.025 V	4.225 ± 0.050 V	2.50 ± 0.080 V	2.90 ± 0.100 V	0.15 ± 0.025 V	Enabled
S-8254ABNFT-TB-U	4.215 ± 0.025 V	4.115 ± 0.050 V	2.80 ± 0.080 V	3.00 ± 0.100 V	0.20 ± 0.025 V	Inhibited

- Remark** 1. Please contact our sales representatives for products other than the above.  
2. x: G or U  
y: S or U  
3. Please select products of environmental code = U for Sn 100%, halogen-free products.

■ **Pin Configuration**

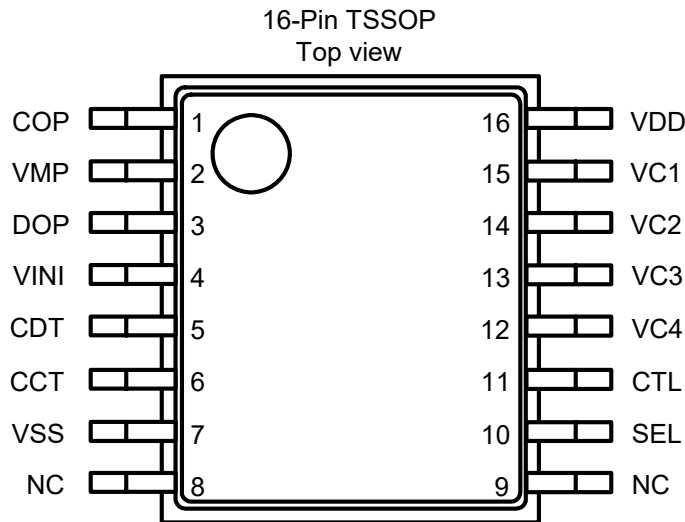

**Figure 2**

**Table 2**

Pin No.	Symbol	Description
1	COP	FET gate connection pin for charge control (Nch open drain output)
2	VMP	Pin for voltage detection between VC1 and VMP (Pin for overcurrent 3 detection)
3	DOP	FET gate connection pin for discharge control FET (CMOS output)
4	VINI	Pin for voltage detection between VSS and VINI (Pin for overcurrent detection 1,2)
5	CDT	Capacitor connection pin for delay for overdischarge detection, delay for overcurrent detection 1
6	CCT	Capacitor connection pin for delay for overcharge current
7	VSS	Input pin for negative power supply, Connection pin for battery 4's negative voltage
8	NC *1	No connection
9	NC *1	No connection
10	SEL	Pin for switching 3-series or 4-series cell V <sub>SS</sub> level: 3-series cell, V <sub>DD</sub> level : 4-series cell
11	CTL	Control of charge FET and discharge FET
12	VC4	Connection pin for battery 3's negative voltage, Connection pin for battery 4's positive voltage
13	VC3	Connection pin for battery 2's negative voltage, Connection pin for battery 3's positive voltage
14	VC2	Connection pin for battery 1's negative voltage, Connection pin for battery 2's positive voltage
15	VC1	Connection pin for battery 1's positive voltage
16	VDD	Input pin for positive power supply, Connection pin for battery 1's positive voltage

\*1. The NC pin is electrically open. The NC pin can be connected to VDD or VSS.

■ **Absolute Maximum Ratings**

**Table 3**

(Ta = 25°C unless otherwise specified)

Item	Symbol	Applied pin	Absolute Maximum Ratings	Unit
Input voltage between VDD and VSS	V <sub>DS</sub>	—	V <sub>SS</sub> – 0.3 to V <sub>SS</sub> + 26	V
Input pin voltage	V <sub>IN</sub>	VC1, VC2, VC3, VC4, CTL, SEL, CCT, CDT, VINI	V <sub>SS</sub> – 0.3 to V <sub>DD</sub> + 0.3	V
VMP pin input voltage	V <sub>VMP</sub>	VMP	V <sub>SS</sub> – 0.3 to V <sub>SS</sub> + 26	V
DOP pin output voltage	V <sub>DOP</sub>	DOP	V <sub>SS</sub> – 0.3 to V <sub>DD</sub> + 0.3	V
COP pin output voltage	V <sub>COP</sub>	COP	V <sub>SS</sub> – 0.3 to V <sub>SS</sub> + 26	V
Power dissipation	P <sub>D</sub>	—	400 (When not mounted on board)	mW
		—	1100*1	mW
Operating ambient temperature	T <sub>opr</sub>	—	– 40 to + 85	°C
Storage temperature	T <sub>stg</sub>	—	– 40 to + 125	°C

\*1. When mounted on board

[Mounted board]

(1) Board size : 114.3 mm × 76.2 mm × t1.6 mm

(2) Board name : JEDEC STANDARD51-7

**Caution** The absolute maximum ratings are rated values exceeding which the product could suffer physical damage. These values must therefore not be exceeded under any conditions.

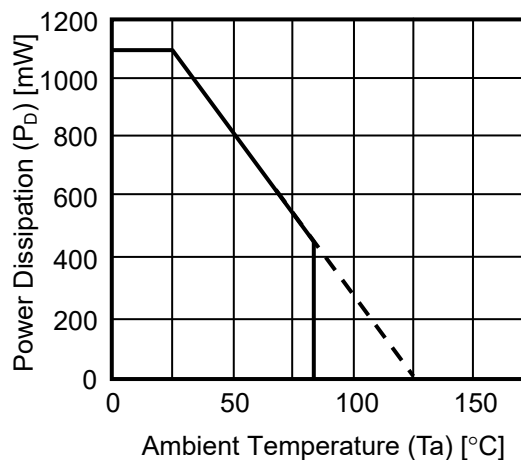

**Figure 3 Power Dissipation of Package (When Mounted on Board)**

**BATTERY PROTECTION IC FOR 3-SERIAL- OR 4-SERIAL-CELL PACK**  
**S-8254A Series**

Rev.5.3\_00

**■ Electrical Characteristics**

**Table 4 (1 / 2)**

(Ta = 25°C unless otherwise specified)

Item	Symbol	Conditions	Min.	Typ.	Max.	Unit	Test circuit
<b>[ DETECTION VOLTAGE ]</b>							
Overcharge detection voltage n (n = 1, 2, 3, 4)	V <sub>CU<sub>n</sub></sub>	3.90 V to 4.45 V, Adjustable	V <sub>CU<sub>n</sub></sub> - 0.025	V <sub>CU<sub>n</sub></sub>	V <sub>CU<sub>n</sub></sub> + 0.025	V	2
Overcharge release voltage n (n = 1, 2, 3, 4)	V <sub>CL<sub>n</sub></sub>	V <sub>CL</sub> ≠ V <sub>CU</sub>	V <sub>CL<sub>n</sub></sub> - 0.05	V <sub>CL<sub>n</sub></sub>	V <sub>CL<sub>n</sub></sub> + 0.05	V	2
		V <sub>CL</sub> = V <sub>CU</sub>	V <sub>CL<sub>n</sub></sub> - 0.025	V <sub>CL<sub>n</sub></sub>	V <sub>CL<sub>n</sub></sub> + 0.025	V	2
Overdischarge detection voltage n (n = 1, 2, 3, 4)	V <sub>DL<sub>n</sub></sub>	2.0 V to 3.0 V, Adjustable	V <sub>DL<sub>n</sub></sub> - 0.08	V <sub>DL<sub>n</sub></sub>	V <sub>DL<sub>n</sub></sub> + 0.08	V	2
Overdischarge release voltage n (n = 1, 2, 3, 4)	V <sub>DU<sub>n</sub></sub>	V <sub>DL</sub> ≠ V <sub>DU</sub>	V <sub>DU<sub>n</sub></sub> - 0.10	V <sub>DU<sub>n</sub></sub>	V <sub>DU<sub>n</sub></sub> + 0.10	V	2
		V <sub>DL</sub> = V <sub>DU</sub>	V <sub>DU<sub>n</sub></sub> - 0.08	V <sub>DU<sub>n</sub></sub>	V <sub>DU<sub>n</sub></sub> + 0.08	V	2
Overcurrent detection voltage 1	V <sub>IOV1</sub>	0.05 V to 0.3 V, Adjustable	V <sub>IOV1</sub> - 0.025	V <sub>IOV1</sub>	V <sub>IOV1</sub> + 0.025	V	2
Overcurrent detection voltage 2	V <sub>IOV2</sub>	—	0.4	0.5	0.6	V	2
Overcurrent detection voltage 3	V <sub>IOV3</sub>	—	V <sub>VC1</sub> - 1.5	V <sub>VC1</sub> - 1.2	V <sub>VC1</sub> - 0.9	V	2
Temperature coefficient 1 *1	T <sub>COE1</sub>	Ta = 0°C to 50°C *3	- 1.0	0	1.0	mV / °C	2
Temperature coefficient 2 *2	T <sub>COE2</sub>	Ta = 0°C to 50°C *3	- 0.5	0	0.5	mV / °C	2
<b>[ DELAY TIME ]</b>							
Overcharge detection delay time	t <sub>CU</sub>	CCT pin capacitance = 0.1 μF	0.5	1.0	1.5	s	3
Overdischarge detection delay time	t <sub>DL</sub>	CDT pin capacitance = 0.1 μF	50	100	150	ms	3
Overcurrent detection delay time 1	t <sub>IOV1</sub>	CDT pin capacitance = 0.1 μF	5	10	15	ms	3
Overcurrent detection delay time 2	t <sub>IOV2</sub>	—	0.4	1	1.6	ms	3
Overcurrent detection delay time 3	t <sub>IOV3</sub>	FET gate capacitance = 2000 pF	100	300	600	μs	3
<b>[ 0 V BATTERY CHARGE ]</b>							
0 V battery charge starting charger voltage	V <sub>0CHA</sub>	0 V battery charge enabled	—	0.8	1.5	V	4
0 V battery charge inhibition battery voltage	V <sub>0INH</sub>	0 V battery charge inhibited	0.4	0.7	1.1	V	4
<b>[ INTERNAL RESISTANCE ]</b>							
Resistance between VMP and VDD	R <sub>VMD</sub>	—	0.5	1	1.5	MΩ	5
Resistance between VMP and VSS	R <sub>VMS</sub>	—	450	900	1800	kΩ	5

**Table 4 (2 / 2)**

(Ta = 25°C unless otherwise specified)

Item	Symbol	Conditions	Min.	Typ.	Max.	Unit	Test circuit
<b>[ INPUT VOLTAGE ]</b>							
Operating voltage between VDD and VSS	V <sub>DSOP</sub>	Output voltage of DOP and COP fixed	2	—	24	V	2
CTL input voltage "H"	V <sub>CTLH</sub>	—	V <sub>DD</sub> × 0.8	—	—	V	2
CTL input voltage "L"	V <sub>CTLL</sub>	—	—	—	V <sub>DD</sub> × 0.2	V	2
SEL input voltage "H"	V <sub>SELH</sub>	—	V <sub>DD</sub> × 0.8	—	—	V	2
SEL input voltage "L"	V <sub>SELL</sub>	—	—	—	V <sub>DD</sub> × 0.2	V	2
<b>[ INPUT CURRENT ]</b>							
Current consumption during operation	I <sub>OPe</sub>	V1 = V2 = V3 = V4 = 3.5 V	—	12	30	μA	1
Current consumption during power-down	I <sub>PdN</sub>	V1 = V2 = V3 = V4 = 1.5 V	—	—	0.1	μA	1
VC1 pin current	I <sub>VC1</sub>	V1 = V2 = V3 = V4 = 3.5 V	—	1.5	3	μA	5
VC2 pin current	I <sub>VC2</sub>	V1 = V2 = V3 = V4 = 3.5 V	-0.3	0	0.3	μA	5
VC3 pin current	I <sub>VC3</sub>	V1 = V2 = V3 = V4 = 3.5 V	-0.3	0	0.3	μA	5
VC4 pin current	I <sub>VC4</sub>	V1 = V2 = V3 = V4 = 3.5 V	-0.3	0	0.3	μA	5
CTL pin current "H"	I <sub>CTLH</sub>	V1 = V2 = V3 = V4 = 3.5 V, V <sub>CTL</sub> = V <sub>DD</sub>	—	—	0.1	μA	5
CTL pin current "L"	I <sub>CTLL</sub>	V1 = V2 = V3 = V4 = 3.5 V, V <sub>CTL</sub> = V <sub>SS</sub>	-0.4	-0.2	—	μA	5
SEL pin current "H"	I <sub>SELH</sub>	V1 = V2 = V3 = V4 = 3.5 V, V <sub>SEL</sub> = V <sub>DD</sub>	—	—	0.1	μA	5
SEL pin current "L"	I <sub>SELL</sub>	V1 = V2 = V3 = V4 = 3.5 V, V <sub>SEL</sub> = V <sub>SS</sub>	-0.1	—	—	μA	5
<b>[ OUTPUT CURRENT ]</b>							
COP pin leakage current	I <sub>COH</sub>	V <sub>COP</sub> = 24 V	—	—	0.1	μA	5
COP pin sink current	I <sub>COL</sub>	V <sub>COP</sub> = V <sub>SS</sub> + 0.5 V	10	—	—	μA	5
DOP pin source current	I <sub>DOH</sub>	V <sub>DOP</sub> = V <sub>DD</sub> - 0.5 V	10	—	—	μA	5
DOP pin sink current	I <sub>DOL</sub>	V <sub>DOP</sub> = V <sub>SS</sub> + 0.5 V	10	—	—	μA	5

- \*1. Voltage temperature coefficient 1 : Overcharge detection voltage
- \*2. Voltage temperature coefficient 2 : Overcurrent detection voltage 1
- \*3. Since products are not screened at high and low temperature, the specification for this temperature range is guaranteed by design, not tested in production.



## ■ Test Circuits

This chapter describes how to test the S-8254A Series when a 4-serial cell is selected by setting the SEL pin to the VDD level. When a 3-serial cell is selected by setting the SEL pin to the VSS level, short the power supply V4.

### 1. Current Consumption during Operation, Current Consumption during Power-down (Test circuit 1)

#### 1. 1 Current Consumption during operation ( $I_{OPE}$ )

The current at the VSS pin when  $V1 = V2 = V3 = V4 = 3.5\text{ V}$  and  $V_{VMP} = V_{DD}$  is the current consumption during operation ( $I_{OPE}$ ).

#### 1. 2 Current Consumption during power-down ( $I_{PDN}$ )

The current at the VSS pin when  $V1 = V2 = V3 = V4 = 1.5\text{ V}$  and  $V_{VMP} = V_{SS}$  is the current consumption during power-down ( $I_{PDN}$ ).

### 2. Overcharge Detection Voltage, Overcharge Release Voltage, Overdischarge Detection Voltage, Overdischarge Release Voltage, Overcurrent Detection Voltage 1, Overcurrent Detection Voltage 2, Overcurrent Detection Voltage 3, CTL Input Voltage “H”, CTL Input Voltage “L”, SEL Input Voltage “H”, SEL Input Voltage “L” (Test circuit 2)

Confirm that the COP pin and DOP pin are low ( $V_{DD} \times 0.1\text{ V}$  or lower) when  $V_{VMP} = V_{SEL} = V_{DD}$ ,  $V_{INI} = V_{CTL} = V_{SS}$ , the CCT pin is open, the CDT pin is open, and  $V1 = V2 = V3 = V4 = 3.5\text{ V}$  (this status is referred to as the initial status).

#### 2. 1 Overcharge Detection Voltage ( $V_{CU1}$ ), Overcharge Release Voltage ( $V_{CL1}$ )

The overcharge detection voltage ( $V_{CU1}$ ) is the voltage of V1 when the voltage of the COP pin is “H” ( $V_{DD} \times 0.9\text{ V}$  or more) after the V1 voltage has been gradually increased starting at the initial status. The overcharge release voltage ( $V_{CL1}$ ) is the voltage of V1 when the voltage at the COP pin is “L” after the V1 voltage has been gradually decreased.

#### 2. 2 Overdischarge Detection Voltage ( $V_{DL1}$ ), Overdischarge Release Voltage ( $V_{DU1}$ )

The overdischarge detection voltage ( $V_{DL1}$ ) is the voltage of V1 when the voltage of the DOP pin is “H” after the V1 voltage has been gradually decreased starting at the initial status. The overdischarge release voltage ( $V_{DU1}$ ) is the voltage of V1 when the voltage at the DOP pin is “L” after the V1 voltage has been gradually increased.

When the voltage of  $V_n$  ( $n = 2$  to  $4$ ) is changed, the overcharge detection voltage ( $V_{CU_n}$ ), overcharge release voltage ( $V_{CL_n}$ ), overdischarge detection voltage ( $V_{DL_n}$ ), and overdischarge release voltage ( $V_{DU_n}$ ) can be determined in the same way as when  $n = 1$ .

#### 2. 3 Overcurrent Detection Voltage 1 ( $V_{IOV1}$ )

Overcurrent detection voltage 1 ( $V_{IOV1}$ ) is the voltage of the VINI pin when the voltage of the DOP pin is “H” after the VINI pin voltage has been gradually increased starting at the initial status.

#### 2. 4 Overcurrent Detection Voltage 2 ( $V_{IOV2}$ )

Overcurrent detection voltage 2 ( $V_{IOV2}$ ) is the voltage of the VINI pin when the voltage of the DOP pin is “H” after the voltage of the CDT pin was set to  $V_{SS}$  following the initial status and the voltage of the VINI pin has been gradually decreased.

#### 2. 5 Overcurrent Detection Voltage 3 ( $V_{IOV3}$ )

Overcurrent detection voltage 3 ( $V_{IOV3}$ ) is the voltage difference between  $V_{VC1}$  and  $V_{VMP}$  ( $V_{VC1} - V_{VMP}$ ) when the voltage of the DOP pin is “H” after the VMP voltage has been gradually decreased starting at the initial status.

## **2. 6 CTL Input Voltage “H” ( $V_{CTLH}$ ), CTL Input Voltage “L” ( $V_{CTL L}$ )**

The CTL input voltage “H” ( $V_{CTLH}$ ) is the voltage of CTL when the voltages at the COP and DOP pins are “H” after the CTL voltage has been gradually increased starting at the initial status. The CTL input voltage “L” ( $V_{CTL L}$ ) is the voltage of CTL when the voltages at the COP and DOP pins are “L” after the CTL voltage has been gradually decreased.

## **2. 7 SEL Input Voltage “H” ( $V_{SELH}$ ), SEL Input Voltage “L” ( $V_{SELL}$ )**

Apply 0 V to V4 in the initial status and confirm that the DOP pin is “H”. The SEL input voltage “L” ( $V_{SELL}$ ) is the voltage of the SEL pin when the voltage at the DOP pin is “L” after the SEL voltage has been gradually decreased. The SEL input voltage “H” ( $V_{SELH}$ ) is the voltage of the SEL pin when the voltage of the DOP pin is “H” after the SEL voltage has been gradually increased.

## **3. Overcharge Detection Delay Time, Overdischarge Detection Delay Time, Overcurrent Detection Delay Time 1, Overcurrent Detection Delay Time 2, Overcurrent Detection Delay Time 3 (Test circuit 3)**

Confirm that the COP pin and DOP pin are “L” when  $V_{VMP} = V_{DD}$ ,  $V_{VINI} = V_{SS}$ , and  $V1 = V2 = V3 = V4 = 3.5$  V (this status is referred to as the initial status).

### **3. 1 Overcharge Detection Delay Time ( $t_{CU}$ )**

The overcharge detection delay time ( $t_{CU}$ ) is the time it takes for the voltage of the COP pin to change from “L” to “H” after the voltage of V1 is instantaneously changed to 4.5 V from the initial status.

### **3. 2 Overdischarge Detection Delay Time ( $t_{DL}$ )**

The overdischarge detection delay time ( $t_{DL}$ ) is the time it takes for the voltage of the DOP pin to change from “L” to “H” after the voltage of V1 is instantaneously changed to 1.5 V from the initial status

### **3. 3 Overcurrent Detection Delay Time 1 ( $t_{IOV1}$ )**

Overcurrent detection delay time 1 ( $t_{IOV1}$ ) is the time it takes for the voltage of the DOP pin to change from “L” to “H” after the voltage of the VINI pin is instantaneously changed to 0.4 V from the initial status.

### **3. 4 Overcurrent Detection Delay Time 2 ( $t_{IOV2}$ )**

Overcurrent detection delay time 2 ( $t_{IOV2}$ ) is the time it takes for the voltage of the DOP pin to change from “L” to “H” after the voltage of the VINI pin is instantaneously changed to  $V_{IOV2 \text{ max.}} + 0.2$  V from the initial status.

### **3. 5 Overcurrent Detection Delay Time 3 ( $t_{IOV3}$ )**

Overcurrent detection delay time 3 ( $t_{IOV3}$ ) is the time it takes for the voltage of the DOP pin to change from “L” to “H” after the voltage of the VMP pin is instantaneously changed to  $V_{IOV3 \text{ min.}} - 0.2$  V from the initial status.

**4. 0 V Battery Charge Starting Charger Voltage (0 V Battery Charge Enabled), 0 V Battery Charge Inhibition Battery Voltage (0 V Battery Charge Inhibited)**  
**(Test circuit 4)**

Either the 0 V battery charge starting charger voltage or the 0 V battery charge inhibition battery voltage is applied to each product according to the 0 V battery charge function.

**4. 1 0 V Battery Charge Starting Charger Voltage ( $V_{0CHA}$ ) (0 V Battery Charge Enabled)**

The starting condition is  $V1 = V2 = V3 = V4 = 0$  V for a product in which 0 V battery charging is available. The COP pin voltage should be lower than  $V_{0CHA} \text{ max.} - 1$  V when the VMP pin voltage  $V_{VMP} = V_{0CHA} \text{ max.}$

**4. 2 0 V Battery Charge Inhibition Battery Voltage ( $V_{0INH}$ ) (0 V Battery Charge Inhibited)**

The starting condition is  $V1 = V2 = V3 = V4 = V_{0INH}$  for a product in which 0 V battery charging is inhibited. The COP pin voltage should be higher than  $V_{VMP} - 1$  V when the VMP pin voltage  $V_{VMP} = 24$  V.

**5. Resistance between VMP and VDD, Resistance between VMP and VSS, VC1 Pin Current, VC2 Pin Current, VC3 Pin Current, VC4 Pin Current, CTL pin Current “H”, CTL Pin Current “L”, SEL Pin Current “H”, SEL Pin Current “L”, COP Pin Leakage Current, COP Pin Sink Current, DOP Pin Source Current, DOP Pin Sink Current**  
**(Test circuit 5)**

$V_{VMP} = V_{SEL} = V_{DD}$ ,  $V_{INI} = V_{CTL} = V_{SS}$ ,  $V1 = V2 = V3 = V4 = 3.5$  V, and other pins left “open” (this status is referred to as the initial status).

**5. 1 Resistance between VMP and VDD ( $R_{VMD}$ )**

The resistance between VMP and VDD ( $R_{VMD}$ ) is obtained from  $R_{VMD} = V_{DD} / I_{VMD}$  using the current value of the VMP pin ( $I_{VMD}$ ) when  $V_{VMP}$  is  $V_{SS}$  after the initial status.

**5. 2 Resistance between VMP and VSS ( $R_{VMS}$ )**

The resistance between VMP and VSS ( $R_{VMS}$ ) is obtained from  $R_{VMS} = V_{DD} / I_{VMS}$  using the current value of the VMP pin ( $I_{VMS}$ ) when  $V1 = V2 = V3 = V4 = 1.8$  V after the initial status.

**5. 3 VC1 Pin Current ( $I_{VC1}$ ), VC2 Pin Current ( $I_{VC2}$ ), VC3 Pin Current ( $I_{VC3}$ ), VC4 Pin Current ( $I_{VC4}$ )**

At the initial status, the current that flows through the VC1 pin is the VC1 pin current ( $I_{VC1}$ ), the current that flows through the VC2 pin is the VC2 pin current ( $I_{VC2}$ ), the current that flows through the VC3 pin is the VC3 pin current ( $I_{VC3}$ ), and the current that flows through the VC4 pin is the VC4 pin current ( $I_{VC4}$ ).

**5. 4 CTL pin Current “H” ( $I_{CTLH}$ ), CTL Pin Current “L” ( $I_{CTLL}$ )**

In the initial status, the current that flows through the CTL pin is the CTL pin current “L” ( $I_{CTLL}$ ), after that, when  $V_{CTL} = V_{DD}$ , the current that flows through the CTL pin is the CTL pin current “H” ( $I_{CTLH}$ ).

**5. 5 SEL Pin Current “H” ( $I_{SELH}$ ), SEL Pin Current “L” ( $I_{SELL}$ )**

In the initial status, the current that flows through the SEL pin is the SEL pin current “H” ( $I_{SELH}$ ), after that, when  $V_{SEL} = V_{SS}$ , the current that flows through the SEL pin is the SEL pin current “L” ( $I_{SELL}$ ).

**5. 6 COP Pin Leakage Current ( $I_{COH}$ ), COP Pin Sink Current ( $I_{COL}$ )**

The COP pin sink current ( $I_{COL}$ ) is the current that flows through the COP pin when  $V_{COP} = V_{SS} + 0.5\text{ V}$  after the initial status. After that, the current that flows through the COP pin when  $V1 = V2 = V3 = V4 = 6\text{ V}$  and  $V_{COP} = V_{DD}$  is the COP pin leakage current ( $I_{COH}$ ).

**5. 7 DOP Pin Source Current ( $I_{DOH}$ ), DOP Pin Sink Current ( $I_{DOL}$ )**

The DOP pin sink current ( $I_{DOL}$ ) is the current that flows through the DOP pin when  $V_{DOP} = V_{SS} + 0.5\text{ V}$  after the initial status. After that, the current that flows through the DOP pin when  $V_{VMP} = V_{DD} - 2\text{ V}$  and  $V_{DOP} = V_{DD} - 0.5\text{ V}$  is the DOP pin source current ( $I_{DOH}$ ).



Figure 4 Test Circuit 1

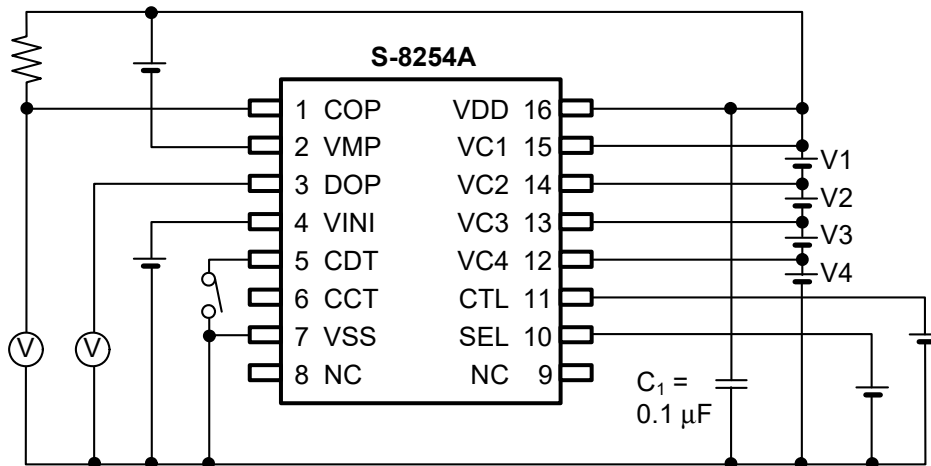

Figure 5 Test Circuit 2

**BATTERY PROTECTION IC FOR 3-SERIAL- OR 4-SERIAL-CELL PACK**  
**S-8254A Series**

Rev.5.3\_00



**Figure 6 Test Circuit 3**



**Figure 7 Test Circuit 4**



**Figure 8 Test Circuit 5**

## ■ Operation

**Remark** Refer to “■ Battery Protection IC Connection Example”.

### 1. Normal Status

When the voltage of each of the batteries is in the range from  $V_{DLn}$  to  $V_{CUn}$  and the discharge current is lower than the specified value (the VINI pin voltage is lower than  $V_{IOV1}$  and  $V_{IOV2}$ , and the VMP pin voltage is higher than  $V_{IOV3}$ ), the charging and discharging FETs are turned on.

### 2. Overcharge Status

When the voltage of one of the batteries becomes higher than  $V_{CUn}$  and the state continues for  $t_{CU}$  or longer, the COP pin becomes high impedance. The COP pin is pulled up to the EB+ pin voltage by an external resistor, and the charging FET is turned off to stop charging. This is called the overcharge status. The overcharge status is released when one of the following two conditions holds.

- (1) The voltage of each of the batteries becomes  $V_{CLn}$  or lower.
- (2) The voltage of each of the batteries is  $V_{CUn}$  or lower, and the VMP pin voltage is  $39 / 40 \times V_{DD}$  or lower (a load is connected and discharging is started via the body diode of the charging FET).

### 3. Overdischarge Status

When the voltage of one of the batteries becomes lower than  $V_{DLn}$  and the state continues for  $t_{DL}$  or longer, the DOP pin voltage becomes  $V_{DD}$  level, and the discharging FET is turned off to stop discharging. This is called the overdischarge status.

#### 3.1 Power-down Function

When the overdischarge status is reached, the VMP pin is pulled down to the  $V_{SS}$  level by the internal  $R_{VMS}$  resistor of the IC. When the VMP pin voltage is  $V_{DD} / 2$  or lower, the power-down function starts to operate and almost every circuit in the S-8254A Series stops working. The conditions of each output pin are as follows.

- (1) COP pin : High-Z
- (2) DOP pin :  $V_{DD}$

The power-down function is released when the following condition holds.

- (1) The VMP pin voltage is  $V_{DD} / 2$  or higher.

The overdischarge status is released when the following two conditions hold.

- (1) In case the VMP pin voltage is  $V_{DD} / 2$  or higher and the VMP pin voltage is lower than  $V_{DD}$ , the overdischarge status is released when the voltage of each of the batteries is  $V_{DUn}$  or higher.
- (2) In case a charger is connected, the overdischarge hysteresis is released. And the overdischarge status is released when the voltage of each of the batteries is  $V_{DLn}$  or higher.

#### 4. Overcurrent Status

The S-8254A Series has three overcurrent detection levels ( $V_{IOV1}$ ,  $V_{IOV2}$ , and  $V_{IOV3}$ ) and three overcurrent detection delay times ( $t_{IOV1}$ ,  $t_{IOV2}$ , and  $t_{IOV3}$ ) corresponding to each overcurrent detection level. When the discharging current becomes higher than the specified value (the voltage between  $V_{SS}$  and  $V_{INI}$  is greater than  $V_{IOV1}$ ) and the state continues for  $t_{IOV1}$  or longer, the S-8254A Series enters the overcurrent status, in which the DOP pin voltage becomes  $V_{DD}$  level to turn off the discharging FET to stop discharging, the COP pin becomes high impedance and is pulled up to the  $EB+$  pin voltage to turn off the charging FET to stop charging, and the VMP pin is pulled up to the  $V_{DD}$  voltage by the internal resistor ( $R_{VMD}$ ). Operation of overcurrent detection level 2 ( $V_{IOV2}$ ) and overcurrent detection delay time 2 ( $t_{IOV2}$ ) is the same as for  $V_{IOV1}$  and  $t_{IOV1}$ .

In the overcurrent status, the VMP pin is pulled up to the  $V_{DD}$  level by the internal resistor in the IC ( $R_{VMD}$  resistor). The overcurrent status is released when the following condition holds.

- (1) The VMP pin voltage is  $V_{IOV3}$  or higher because a charger is connected or the load (30 M $\Omega$  or more) is released.

#### 5. 0 V Battery Charge

Regarding the charging of a self-discharged battery (0 V battery), the S-8254A Series has two functions from which one should be selected.

- (1) 0 V battery charging is allowed (0 V battery charge enabled)  
When the charger voltage is higher than  $V_{0CHA}$ , the 0 V battery can be charged.
- (2) 0 V battery charging is prohibited (0 V battery charge inhibited)  
When the battery voltage is  $V_{0INH}$  or lower, the 0 V battery cannot be charged.

**Caution** When the VDD pin voltage is lower than the minimum value of  $V_{DSOP}$ , the operation of the S-8254A Series is not guaranteed.

#### 6. Delay Time Setting

The overcharge detection delay time ( $t_{CU}$ ) is determined by the external capacitor connected to the CCT pin. The overdischarge detection delay time ( $t_{DL}$ ) and overcurrent detection delay time 1 ( $t_{IOV1}$ ) are determined by the external capacitor connected to the CDT pin. Overcurrent detection delay times 2 and 3 ( $t_{IOV2}$ ,  $t_{IOV3}$ ) are fixed internally.

	min.	typ.	max.	
$t_{CU}$ [s] =	(5.00,	10.0,	15.0)	$\times C_{CCT}$ [ $\mu$ F]
$t_{DL}$ [s] =	(0.50,	1.00,	1.50)	$\times C_{CDT}$ [ $\mu$ F]
$t_{IOV1}$ [s] =	(0.05,	0.10,	0.15)	$\times C_{CDT}$ [ $\mu$ F]

#### 7. CTL Pin

The S-8254A Series has control pins. The CTL pin is used to control the COP and DOP pin output voltages. CTL pin takes precedence over the battery protection circuit.

**Table 5 Conditions Set by CTL Pin**

CTL Pin	COP Pin	DOP Pin
High	High-Z	$V_{DD}$
Open	High-Z	$V_{DD}$
Low	Normal status *1	Normal status *1

\*1. The status is controlled by the voltage detector.

**Caution** Please note unexpected behavior might occur when electrical potential difference between the CTL pin ('L' level) and  $V_{SS}$  is generated through the external filter ( $R_{VSS}$  and  $C_{VSS}$ ) as a result of input voltage fluctuations.

**8. SEL pin**

The S-8254A Series has control pins. The SEL pin is used to switch between 3-cell and 4-cell protection. When the SEL pin is low, overdischarge detection of the V4 cell is prohibited and an overdischarge is not detected even if the V4 cell is shorted, therefore, the V4 cell can be used for 3-cell protection. The SEL pin takes precedence over the battery protection circuit. Use the SEL pin at high or low.

**Table 6 Conditions Set by SEL Pin**

SEL Pin	Condition
High	4-cell protection
Open	Undefined
Low	3-cell protection



■ Timing Chart

1. Overcharge Detection and Overdischarge Detection



- \*1. < 1 > : Normal status
- < 2 > : Overcharge status
- < 3 > : Overdischarge status
- < 4 > : Power-down status

**Remark** The charger is assumed to charge with a constant current.  $V_{EB+}$  indicates the open voltage of the charger.

Figure 9

**2. Overcurrent detection**



\*1.  $\langle 1 \rangle$  : Normal status  
 $\langle 2 \rangle$  : Overcurrent status

**Remark** The charger is assumed to charge with a constant current.  $V_{EB+}$  indicates the open voltage of the charger.

**Figure 10**

■ **Battery Protection IC Connection Example**

**1. 3-serial Cell**



Figure 11

**2. 4-serial Cell**



Figure 12

**Table 7 Constants for External Components**

Symbol	Min.	Typ.	Max.	Unit
R <sub>VC1</sub> <sup>*1</sup>	0	1	1	kΩ
R <sub>VC2</sub> <sup>*1</sup>	0	1	1	kΩ
R <sub>VC3</sub> <sup>*1</sup>	0	1	1	kΩ
R <sub>VC4</sub> <sup>*1</sup>	0	1	1	kΩ
R <sub>DOP</sub>	2	5.1	10	kΩ
R <sub>COP</sub>	0.1	1	1	MΩ
R <sub>VMP</sub>	1	5.1	10	kΩ
R <sub>CTL</sub>	1	1	100	kΩ
R <sub>VINI</sub>	1	1	100	kΩ
R <sub>SEL</sub>	1	1	100	kΩ
R <sub>SENSE</sub>	0	—	—	mΩ
R <sub>VSS</sub> <sup>*1</sup>	10	51	51	Ω
C <sub>VC1</sub> <sup>*1</sup>	0	0.1	0.33	μF
C <sub>VC2</sub> <sup>*1</sup>	0	0.1	0.33	μF
C <sub>VC3</sub> <sup>*1</sup>	0	0.1	0.33	μF
C <sub>VC4</sub> <sup>*1</sup>	0	0.1	0.33	μF
C <sub>CCT</sub>	0.01	0.1	—	μF
C <sub>CDT</sub>	0.07	0.1	—	μF
C <sub>VSS</sub> <sup>*1</sup>	2.2	2.2	10	μF

\*1. Please set up a filter constant to be  $R_{VSS} \times C_{VSS} \geq 51 \mu\text{F} \cdot \Omega$  and to be  $R_{VC1} \times C_{VC1} = R_{VC2} \times C_{VC2} = R_{VC3} \times C_{VC3} = R_{VC4} \times C_{VC4} = R_{VSS} \times C_{VSS}$ .

**Caution 1. The constants may be changed without notice.**

- It is recommended that filter constants between VDD and VSS should be set approximately to  $112 \mu\text{F} \cdot \Omega$ .

e.g.  $C_{VSS} \times R_{VSS} = 2.2 \mu\text{F} \times 51 \Omega = 112 \mu\text{F} \cdot \Omega$

Enough evaluation of transient power supply variation and overcurrent protection function in the actual application is needed to determine the proper constants. Contact our sales representatives in case the constants should be set to other than  $112 \mu\text{F} \cdot \Omega$  or so.

- It has not been confirmed whether the operation is normal or not in circuits other than the connection examples. In addition, the connection examples and the constants do not guarantee proper operation. Perform thorough evaluation using the actual application to set the constants.

**■ Precautions**

- The application conditions for the input voltage, output voltage, and load current should not exceed the package power dissipation.
- Batteries can be connected in any order, however, there may be cases when discharging cannot be performed when a battery is connected. In this case, short the VMP pin and VDD pin or connect the battery charger to return to the normal status.
- When an overcharged battery and an overdischarged battery intermix, the circuit is in both the overcharge and overdischarge statuses, so charging and discharging are not possible.
- Do not apply an electrostatic discharge to this IC that exceeds the performance ratings of the built-in electrostatic protection circuit.
- ABLIC Inc. claims no responsibility for any disputes arising out of or in connection with any infringement by products including this IC of patents owned by a third party.

■ Characteristics (Typical Data)

1. Current Consumption

1.1 I<sub>OPe</sub> vs. V<sub>DD</sub>

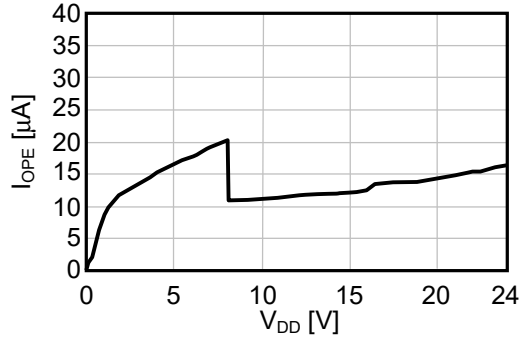

1.2 I<sub>OPe</sub> vs. Ta



1.3 I<sub>PDN</sub> vs. V<sub>DD</sub>



1.4 I<sub>PDN</sub> vs. Ta



2. Overcharge Detection / Release Voltage, Overdischarge Detection / Release Voltage, Overcurrent Detection Voltage, and Delay Times

2.1 V<sub>CU</sub> vs. Ta



2.2 V<sub>CL</sub> vs. Ta

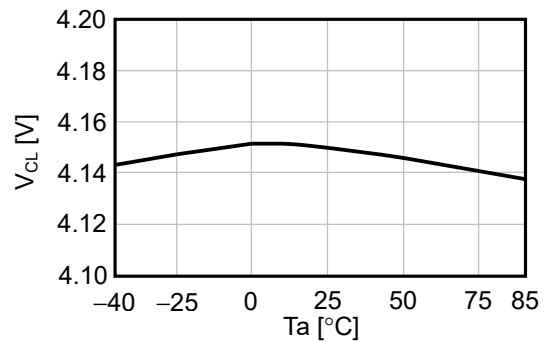

2.3 V<sub>DU</sub> vs. Ta



2.4 V<sub>DL</sub> vs. Ta

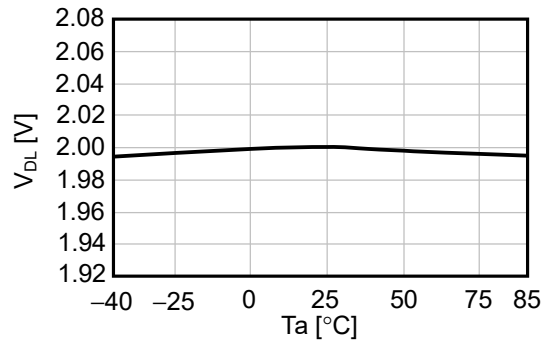

**2. 5  $V_{IOV1}$  vs.  $V_{DD}$**



**2. 6  $V_{IOV1}$  vs.  $T_a$**

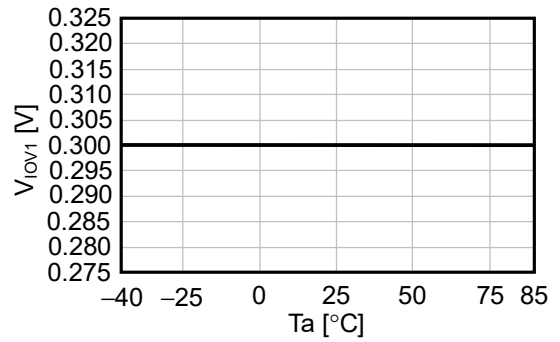

**2. 7  $V_{IOV2}$  vs.  $V_{DD}$**



**2. 8  $V_{IOV2}$  vs.  $T_a$**

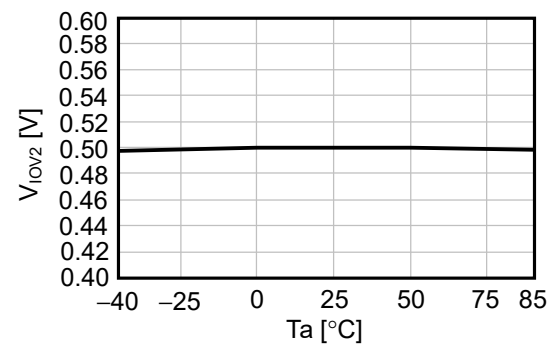

**2. 9  $V_{IOV3}$  vs.  $V_{DD}$**



**2. 10  $V_{IOV3}$  vs.  $T_a$**

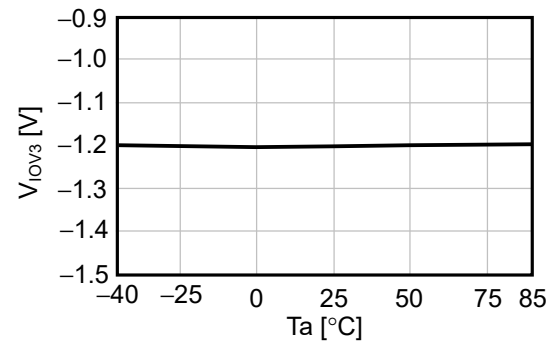

**2. 11  $t_{CU}$  vs.  $C_{CCT}$**



**2. 12  $t_{CU}$  vs.  $T_a$**



**2. 13  $t_{DL}$  vs.  $C_{CDT}$**



**2. 14  $t_{DL}$  vs.  $T_a$**



**2. 15  $t_{IOV1}$  vs.  $C_{CDT}$**



**2. 16  $t_{IOV1}$  vs.  $T_a$**



**2. 17  $t_{IOV2}$  vs.  $T_a$**



**2. 18  $t_{IOV3}$  vs.  $T_a$**



**3. COP / DOP Pin**

**3.1  $I_{COH}$  vs.  $V_{COP}$**



**3.2  $I_{COL}$  vs.  $V_{COP}$**



**3.3  $I_{DOH}$  vs.  $V_{DOP}$**



**3.4  $I_{DOL}$  vs.  $V_{DOP}$**







No. FT016-A-P-SD-1.2

TITLE	TSSOP16-A-PKG Dimensions
No.	FT016-A-P-SD-1.2
ANGLE	
UNIT	mm
<b>ABLIC Inc.</b>	



No. FT016-A-C-SD-1.1

TITLE	TSSOP16-A-Carrier Tape
No.	FT016-A-C-SD-1.1
ANGLE	
UNIT	mm
<b>ABLIC Inc.</b>	



Enlarged drawing in the central part

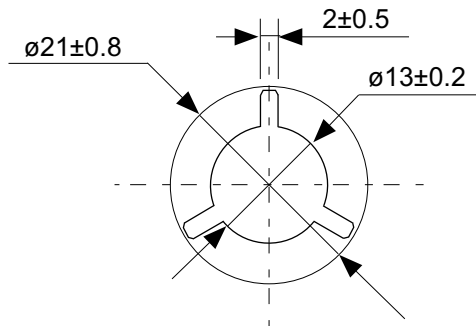

No. FT016-A-R-SD-2.0

TITLE	TSSOP16-A- Reel		
No.	FT016-A-R-SD-2.0		
ANGLE		QTY.	2,000
UNIT	mm		
<b>ABLIC Inc.</b>			



Enlarged drawing in the central part



No. FT016-A-R-S1-1.0

TITLE	TSSOP16-A- Reel		
No.	FT016-A-R-S1-1.0		
ANGLE		QTY.	4,000
UNIT	mm		
<b>ABLIC Inc.</b>			

## Disclaimers (Handling Precautions)

1. All the information described herein (product data, specifications, figures, tables, programs, algorithms and application circuit examples, etc.) is current as of publishing date of this document and is subject to change without notice.
2. The circuit examples and the usages described herein are for reference only, and do not guarantee the success of any specific mass-production design.  
ABLIC Inc. is not liable for any losses, damages, claims or demands caused by the reasons other than the products described herein (hereinafter "the products") or infringement of third-party intellectual property right and any other right due to the use of the information described herein.
3. ABLIC Inc. is not liable for any losses, damages, claims or demands caused by the incorrect information described herein.
4. Be careful to use the products within their ranges described herein. Pay special attention for use to the absolute maximum ratings, operation voltage range and electrical characteristics, etc.  
ABLIC Inc. is not liable for any losses, damages, claims or demands caused by failures and / or accidents, etc. due to the use of the products outside their specified ranges.
5. Before using the products, confirm their applications, and the laws and regulations of the region or country where they are used and verify suitability, safety and other factors for the intended use.
6. When exporting the products, comply with the Foreign Exchange and Foreign Trade Act and all other export-related laws, and follow the required procedures.
7. The products are strictly prohibited from using, providing or exporting for the purposes of the development of weapons of mass destruction or military use. ABLIC Inc. is not liable for any losses, damages, claims or demands caused by any provision or export to the person or entity who intends to develop, manufacture, use or store nuclear, biological or chemical weapons or missiles, or use any other military purposes.
8. The products are not designed to be used as part of any device or equipment that may affect the human body, human life, or assets (such as medical equipment, disaster prevention systems, security systems, combustion control systems, infrastructure control systems, vehicle equipment, traffic systems, in-vehicle equipment, aviation equipment, aerospace equipment, and nuclear-related equipment), excluding when specified for in-vehicle use or other uses by ABLIC, Inc. Do not apply the products to the above listed devices and equipments.  
ABLIC Inc. is not liable for any losses, damages, claims or demands caused by unauthorized or unspecified use of the products.
9. In general, semiconductor products may fail or malfunction with some probability. The user of the products should therefore take responsibility to give thorough consideration to safety design including redundancy, fire spread prevention measures, and malfunction prevention to prevent accidents causing injury or death, fires and social damage, etc. that may ensue from the products' failure or malfunction.  
The entire system in which the products are used must be sufficiently evaluated and judged whether the products are allowed to apply for the system on customer's own responsibility.
10. The products are not designed to be radiation-proof. The necessary radiation measures should be taken in the product design by the customer depending on the intended use.
11. The products do not affect human health under normal use. However, they contain chemical substances and heavy metals and should therefore not be put in the mouth. The fracture surfaces of wafers and chips may be sharp. Be careful when handling these with the bare hands to prevent injuries, etc.
12. When disposing of the products, comply with the laws and ordinances of the country or region where they are used.
13. The information described herein contains copyright information and know-how of ABLIC Inc. The information described herein does not convey any license under any intellectual property rights or any other rights belonging to ABLIC Inc. or a third party. Reproduction or copying of the information from this document or any part of this document described herein for the purpose of disclosing it to a third-party is strictly prohibited without the express permission of ABLIC Inc.
14. For more details on the information described herein or any other questions, please contact ABLIC Inc.'s sales representative.
15. This Disclaimers have been delivered in a text using the Japanese language, which text, despite any translations into the English language and the Chinese language, shall be controlling.

2.4-2019.07

# Mouser Electronics

Authorized Distributor

Click to View Pricing, Inventory, Delivery & Lifecycle Information:

## ABLIC:

[S-8254AAJFT-TB-G](#) [S-8254AAAFT-TB-G](#) [S-8254AABFT-TB-G](#) [S-8254AAFFT-TB-G](#) [S-8254AAGFT-TB-G](#) [S-8254AAHFT-TB-G](#) [S-8254AAIFT-TB-G](#) [S-8254AAKFT-TB-G](#) [S-8254AALFT-TB-G](#) [S-8254AAMFT-TB-G](#) [S-8254AANFT-TB-G](#) [S-8254ABCFT-TB-G](#) [S-8254ABDFT-TB-S](#) [S-8254ABEFT-TB-S](#) [S-8254ABFFT-TB-G](#) [S-8254ABGFT-TB-G](#) [S-8254ABHFT-TB-S](#) [S-8254ABIFT-TB-G](#) [S-8254AAOFT-TB-G](#) [S-8254AAPFT-TB-G](#) [S-8254AAQFT-TB-G](#) [S-8254AARFT-TB-G](#) [S-8254AASFT-TB-G](#) [S-8254AATFT-TB-G](#) [S-8254AAUFT-TB-G](#) [S-8254AAVFT-TB-G](#) [S-8254AAWFT-TB-G](#) [S-8254AAXFT-TB-G](#) [S-8254AAZFT-TB-G](#) [S-8254ABAFT-TB-G](#) [S-8254ABBFT-TB-G](#) [S-8254AAFFT-TB-U](#) [S-8254AAQFT-TB-U](#) [S-8254AANFT-TB-U](#) [S-8254AAZFT-TB-U](#) [S-8254AABFT-TB-U](#) [S-8254ABIFT-TB-U](#) [S-8254ABHFT-TB-U](#) [S-8254AAUFT-TB-U](#) [S-8254ABEFT-TB-U](#) [S-8254AAEFT-TB-G](#) [S-8254AAGFT-TB-U](#) [S-8254AAMFT-TB-U](#) [S-8254ABDFT-TB-U](#) [S-8254ABAFT-TB-U](#) [S-8254AAKFT-TB-U](#) [S-8254AAOFT-TB-U](#) [S-8254AAPFT-TB-U](#) [S-8254ABCFT-TB-U](#) [S-8254AAVFT-TB-U](#) [S-8254AALFT-TB-U](#) [S-8254AAZFT-TB-U](#) [S-8254AAEFT-TB-U](#) [S-8254AARFT-TB-U](#) [S-8254AATFT-TB-U](#) [S-8254ABFFT-TB-U](#) [S-8254BCHFT-TB-U](#) [S-8254AAWFT-TB-U](#) [S-8254ABLFT-TB-U](#) [S-8254BCIFT-TB-U](#) [S-8254ABKFT-TB-U](#) [S-8254BCGFT-TB-U](#) [S-8254AAJFT-TB-U](#) [S-8254ABJFT-TB-U](#) [S-8254ABMFT-TB-U](#) [S-8254AAEFT-TB-U](#) [S-8254ABNFT-TB-U](#)



Компания «ЭлектроПласт» предлагает заключение долгосрочных отношений при поставках импортных электронных компонентов на взаимовыгодных условиях!

Наши преимущества:

- Оперативные поставки широкого спектра электронных компонентов отечественного и импортного производства напрямую от производителей и с крупнейших мировых складов;
- Поставка более 17-ти миллионов наименований электронных компонентов;
- Поставка сложных, дефицитных, либо снятых с производства позиций;
- Оперативные сроки поставки под заказ (от 5 рабочих дней);
- Экспресс доставка в любую точку России;
- Техническая поддержка проекта, помощь в подборе аналогов, поставка прототипов;
- Система менеджмента качества сертифицирована по Международному стандарту ISO 9001;
- Лицензия ФСБ на осуществление работ с использованием сведений, составляющих государственную тайну;
- Поставка специализированных компонентов (Xilinx, Altera, Analog Devices, Intersil, Interpoint, Microsemi, Aeroflex, Peregrine, Syfer, Eurofarad, Texas Instrument, Miteq, Cobham, E2V, MA-COM, Hittite, Mini-Circuits, General Dynamics и др.);

Помимо этого, одним из направлений компании «ЭлектроПласт» является направление «Источники питания». Мы предлагаем Вам помощь Конструкторского отдела:

- Подбор оптимального решения, техническое обоснование при выборе компонента;
- Подбор аналогов;
- Консультации по применению компонента;
- Поставка образцов и прототипов;
- Техническая поддержка проекта;
- Защита от снятия компонента с производства.



#### Как с нами связаться

**Телефон:** 8 (812) 309 58 32 (многоканальный)

**Факс:** 8 (812) 320-02-42

**Электронная почта:** [org@eplast1.ru](mailto:org@eplast1.ru)

**Адрес:** 198099, г. Санкт-Петербург, ул. Калинина, дом 2, корпус 4, литера А.