

REVISIONS				
P.	LTM	DESCRIPTION	DATE	APPROV
H5		ADD NEW DASH NUMBER	24APR2014	CZ SZ

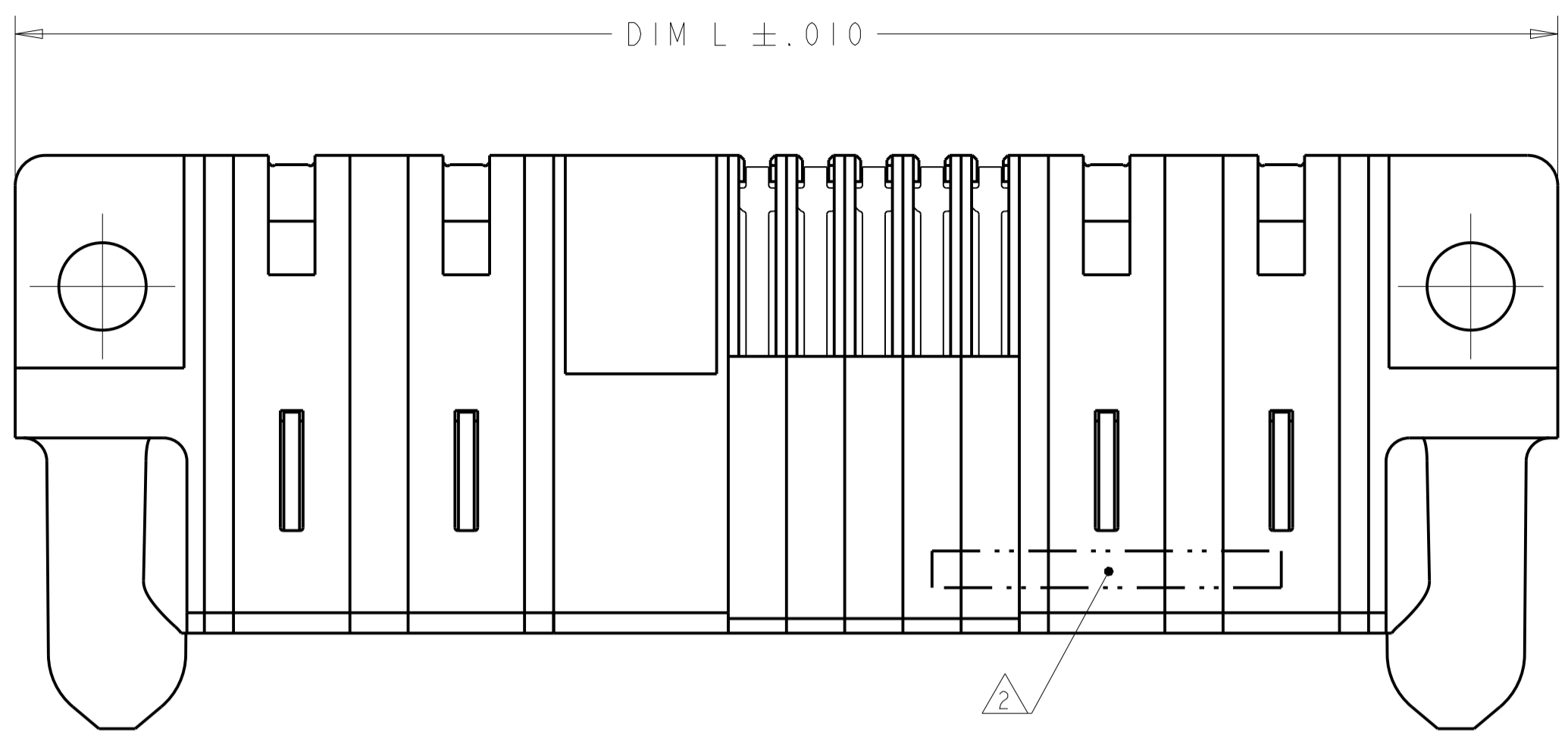

- 1 OPTIONAL CENTER MODULE, WITH .150 THRU HOLE OR HOLD DOWN FEATURE.
- 2 "AMP", PART NUMBER, AND DATE CODE TO BE MARKED IN AREA SHOWN.
- 3 MATERIAL: HOUSING - GLASS FILLED HIGH TEMP THERMO PLASTIC, UL94 V-O, BLACK.
SIGNAL CONTACT - HIGH CONDUCTIVITY COPPER ALLOY
POWER CONTACT - HIGH CONDUCTIVITY COPPER ALLOY
- 4 CONTACT PLATING: NOBLE METAL PLATING ON CONTACT FUNCTIONAL AREA OF POWER AND SIGNAL CONTACTS
- 5 MECHANICAL CONNECTOR KEEP OUT ZONE.
- 6 DATUM AND BASIC DIMENSIONS ESTABLISHED BY CUSTOMER.
- 7 PCB - ALL HOLE DIAMETERS ARE FINISHED HOLE SIZES.
- 8 PCB - 0.0453 +/- .0010 DRILLED HOLES PLATED WITH .0003 MIN. Sn OVER .001 TO .003 CU PLATING TO ACHIEVE A .040±.003 HOLE.
- 9 VARIABLE DIMENSION SHOW ON VIEW (SHEET 3).

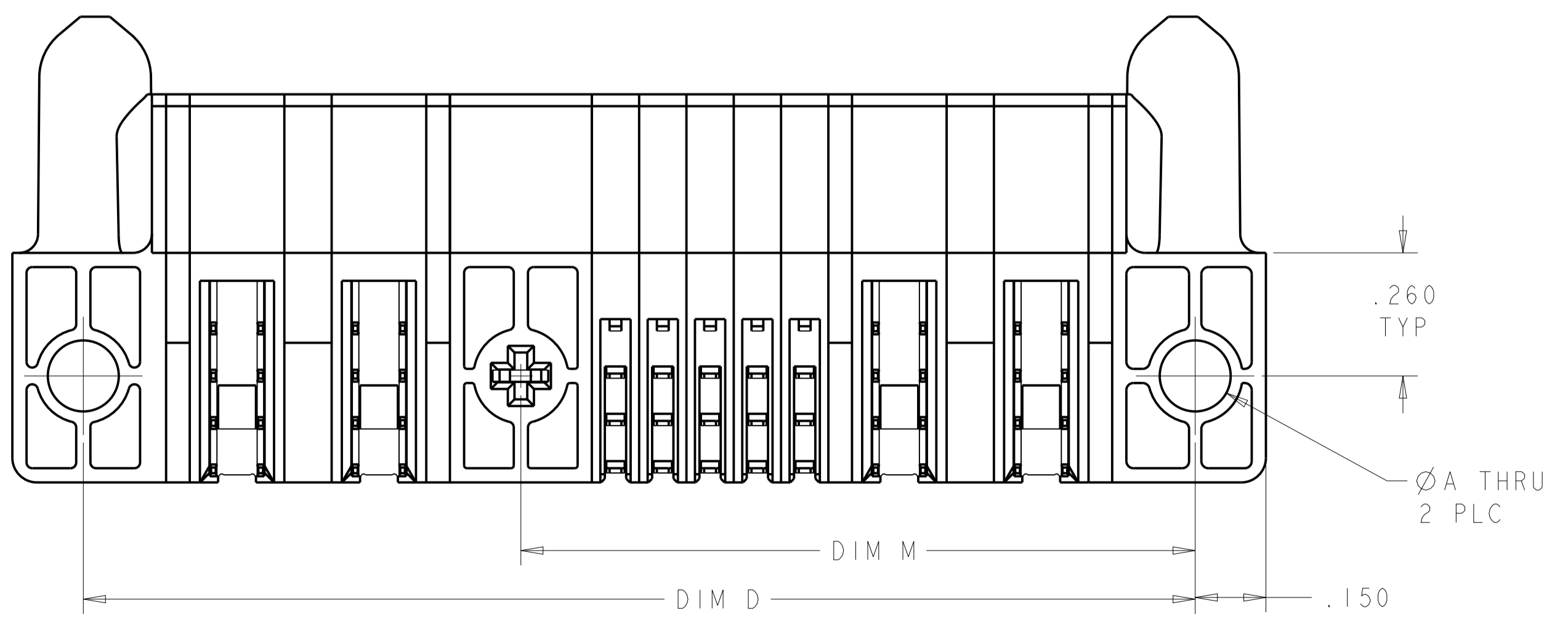
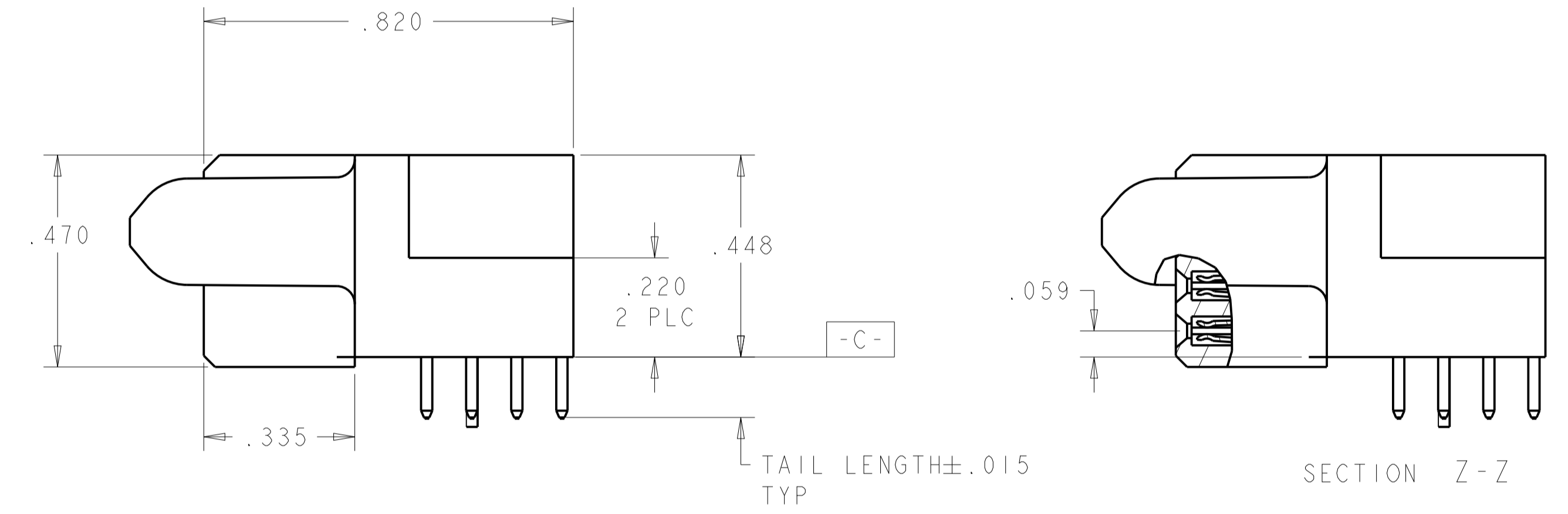
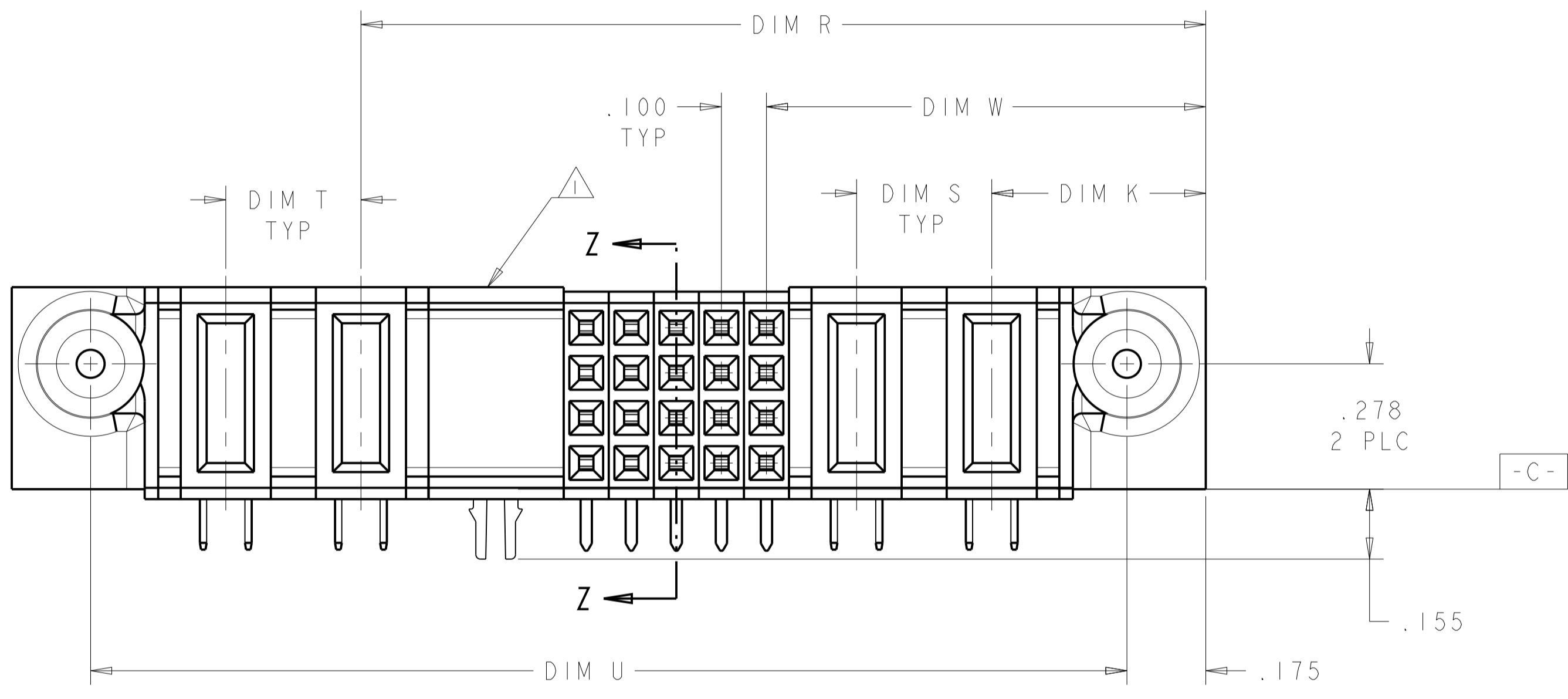

DIM A	DIM T	DIM S	DIM U	DIM R	DIM W	DIM D	DIM M	DIM L	DIM K	DESCRIPTION	PART NUMBER
.122	-	.250	2.750	2.650	1.375	2.800	-	3.100	.450	4P + 48S + 1P	1-6450360-6
.122	-	.200	2.700	2.600	1.425	2.750	-	3.050	.450	5P+44S+1P	1-6450360-5
.150	.200	.200	1.600	1.300	.825	1.650	-	1.950	.450	2HDP + 16S + 2HDP	1-6450360-4
.150	.200	.200	2.400	2.100	.825	2.450	-	2.750	.450	2P + 48S + 2P	1-6450360-3
.150	-	-	1.200	1.100	.625	1.250	-	1.550	.450	1P + 16S + 1P	1-6450360-2
.150	9	.250	2.550	1.550	.875	2.600	-	2.900	.450	2P + 24S + 1P + 3ACP	1-6450360-1
.150	.200	9	2.750	1.450	1.175	2.800	-	3.100	.450	3P + 8S + 7HDP	1-6450360-0
.150	.300	.250	3.200	2.475	1.875	3.250	-	3.550	.450	6P + 16S + 3ACP	6450360-9
.150	.250	.250	1.600	1.250	.925	1.650	-	1.950	.450	2P + 8S + 2P	6450360-8
.150	.250	.250	1.600	1.250	.875	1.650	-	1.950	.450	2P + 12S + 2P	6450360-7
.150	.300	.300	2.000	1.575	.975	2.050	-	2.350	.475	2P + 20S + 2P	6450360-1

THIS DRAWING IS A CONTROLLED DOCUMENT. DIMENSIONS: INCHES. TOLERANCES UNLESS OTHERWISE SPECIFIED: 0 PLC ±.01, 2 PLC ±.01, 3 PLC ±.005, 4 PLC ±.0020, ANGLES ±.020. MATERIAL: 3. FINISH: 4.

DRW: R. GRZYBOWSKI, CHK: M. PERCHERKE, APVD: M. PERCHERKE. PRODUCT SPEC: 108-1973, APPLICATION SPEC: 114-13038. WEIGHT: -. CUSTOMER DRAWING.

OBAPROS, M. PERCHERKE, NAME: RIGHT ANGLE RECEPTACLE ASSEMBLY WITH GUIDES MULTI-BEAM XL. SIZE: A1, CAGE CODE: 100779, DRAWING NO: 6450360. RESTRICTED TO: -. SCALE: 4:1, SHEET: 1 OF 6, REV: H5.

REVISIONS				
P. LTR.	DESCRIPTION	DATE	OWN	APVD
-	SEE SHEET 1	-	-	-

PART NUMBER	ROWS	POWER							SIGNAL		POWER		
		P10	P9	P8	P7	P6	P5	P4	2	1	P3	P2	P1
I-6450360-0	D C B A	RM	RM	RM	RM	RM	RM	RM	H	H	RM	RM	RM
									G	G			
									F	F			
									E	E			

PART NUMBER	ROWS	POWER				SIGNAL						POWER	
		P6	P5	P4	P3	6	5	4	3	2	1	P2	P1
I-6450360-1	D C B A	RM	RM	RM	RM	H	H	H	H	H	H	RM	RM
						G	G	G	G	G	G		
						F	F	F	F	F	F		
						E	E	E	E	E	E		

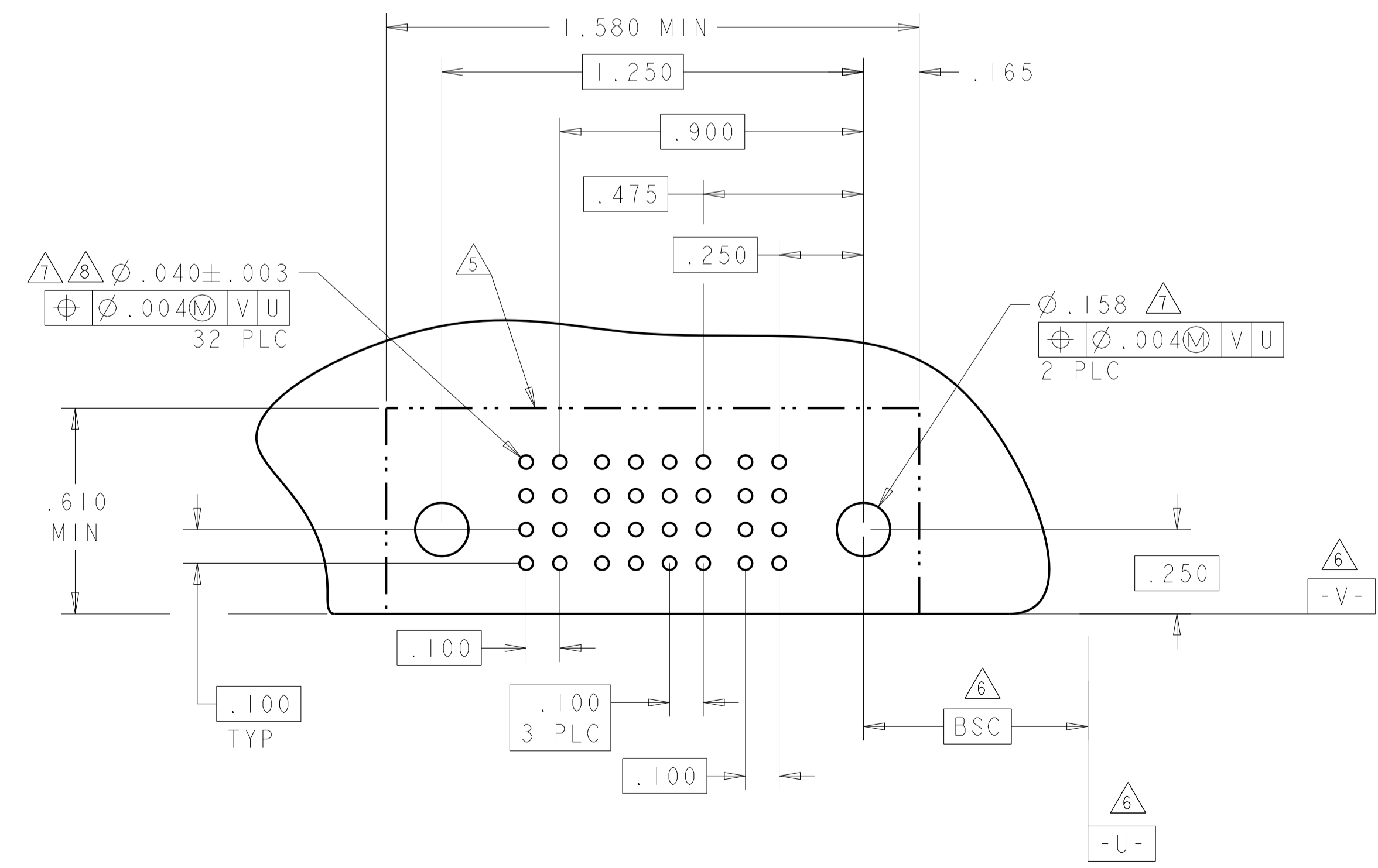
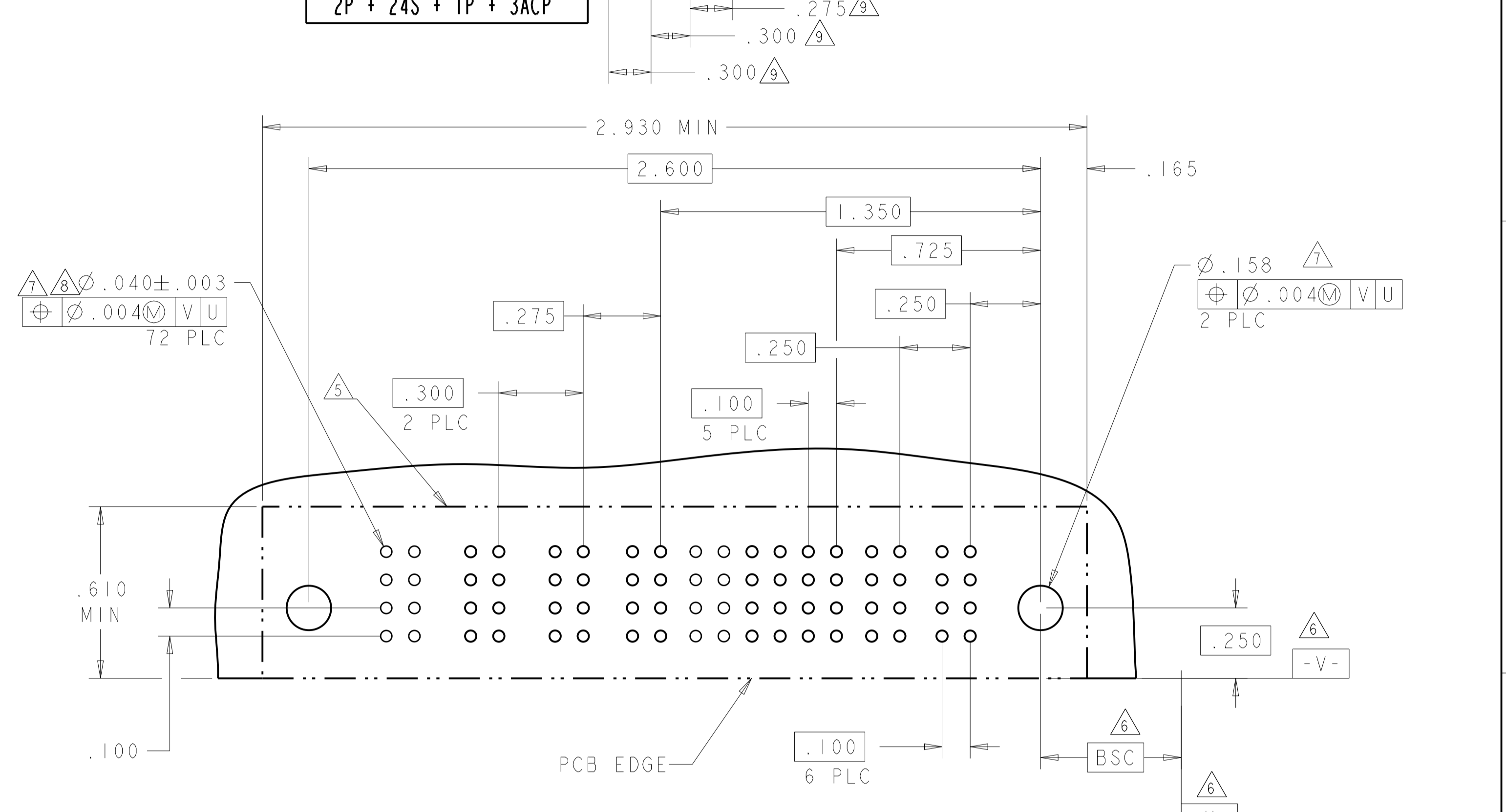
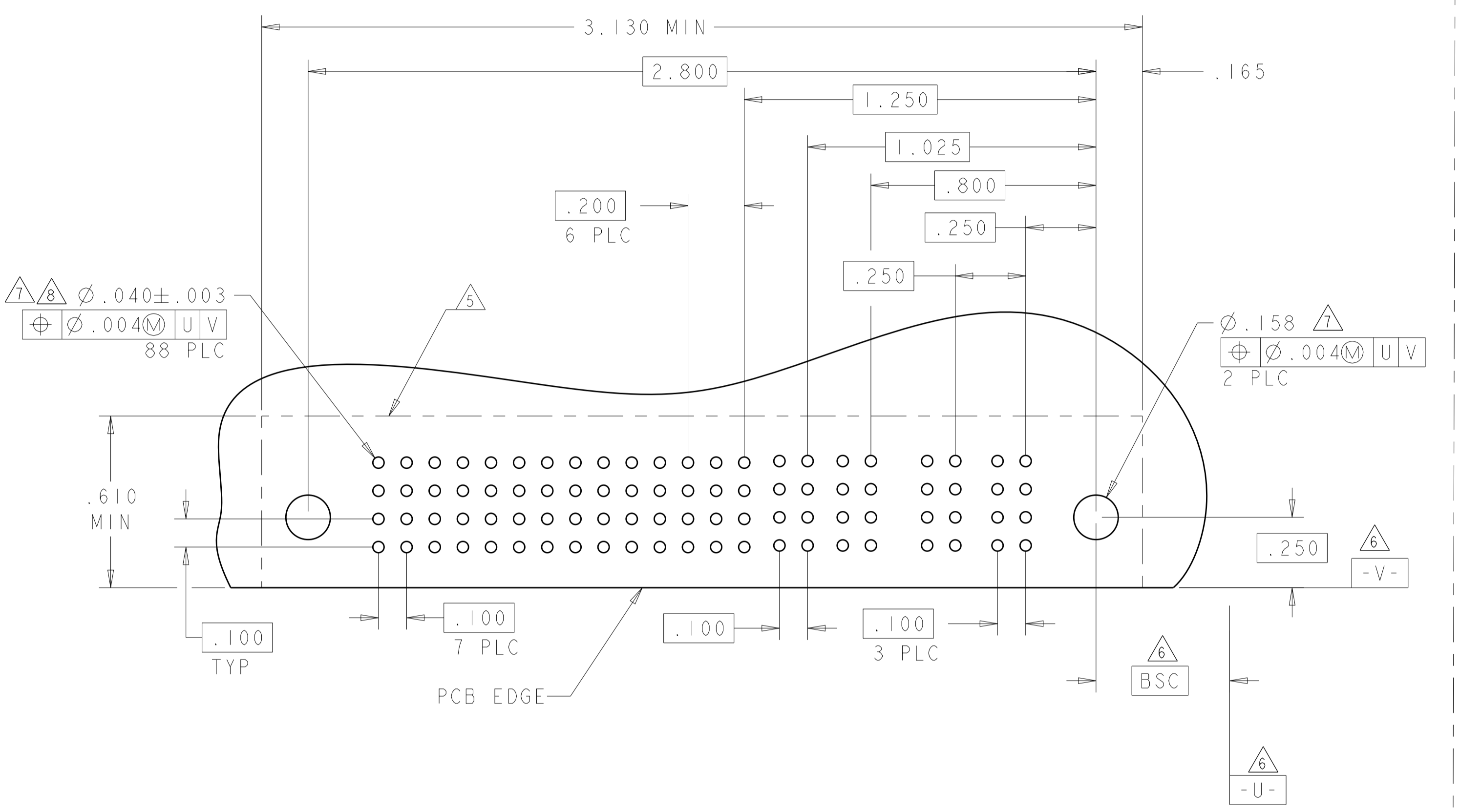

PART NUMBER	ROWS	POWER		SIGNAL				POWER
		P2	P1	4	3	2	1	P1
I-6450360-2	D C B A	RA		H	H	H	H	RA
				G	G	G	G	
				F	F	F	F	
				E	E	E	E	

THIS DRAWING IS A CONTROLLED DOCUMENT.		OWN: R. GRZYBOWSKI CHK: M. PERCHERKE APVD: M. PERCHERKE	OBAPROS OBAPROS	STE TE Connectivity
DIMENSIONS: INCHES	TOLERANCES UNLESS OTHERWISE SPECIFIED:	PRODUCT SPEC: 108-1973 APPLICATION SPEC: 114-13038 WEIGHT: - CAGE CODE: A100779		
MATERIAL: - FINISH: -		CUSTOMER DRAWING		NAME: RIGHT ANGLE RECEPTACLE ASSEMBLY WITH GUIDES MULTI-BEAM XL SIZE: 3 OF 6 SCALE: 4:1 REV: H5

REVISIONS				
P.	LTN	DESCRIPTION	DATE	APVD
-	-	SEE SHEET 1	-	-

PART NUMBER	ROWS	POWER		SIGNAL												POWER	
		P4	P3	12	11	10	9	8	7	6	5	4	3	2	1	P2	P1
1-6450360-3	D	RM	RM	H	H	H	H	H	H	H	H	H	H	H	H	RM	RM
	C			G	G	G	G	G	G	G	G	G	G	G			
	B			F	F	F	F	F	F	F	F	F	F	F	F		
	A			E	E	E	E	E	E	E	E	E	E	E	E		

2P + 48S + 2P

PART NUMBER	ROWS	POWER		SIGNAL				POWER	
		P4	P3	4	3	2	1	P2	P1
1-6450360-4	D	RM	RM	H	H	H	H	RM	RM
	C			G	G	G	G		
	B			F	F	F	F		
	A			E	E	E	E		

2P + 16S + 2P

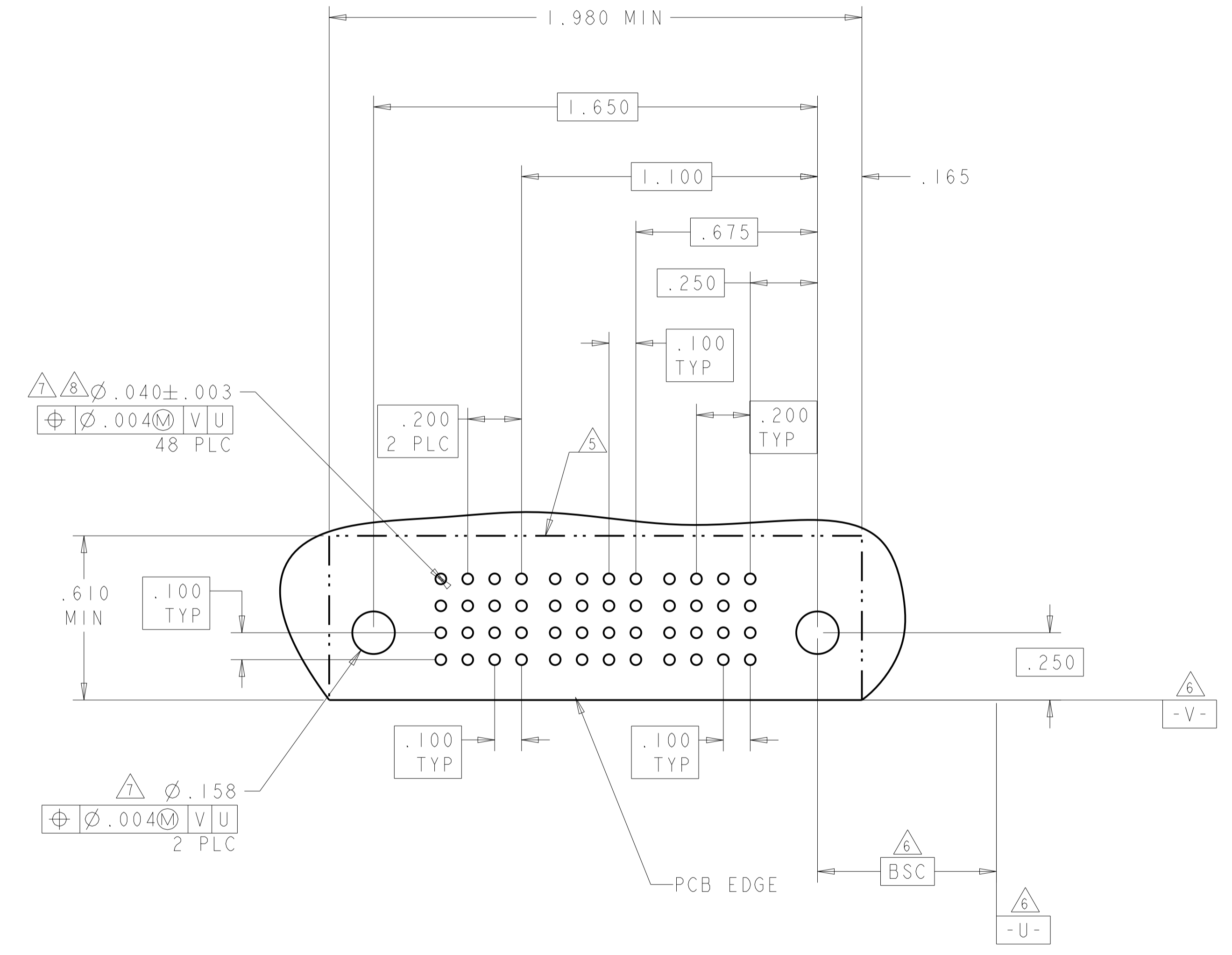
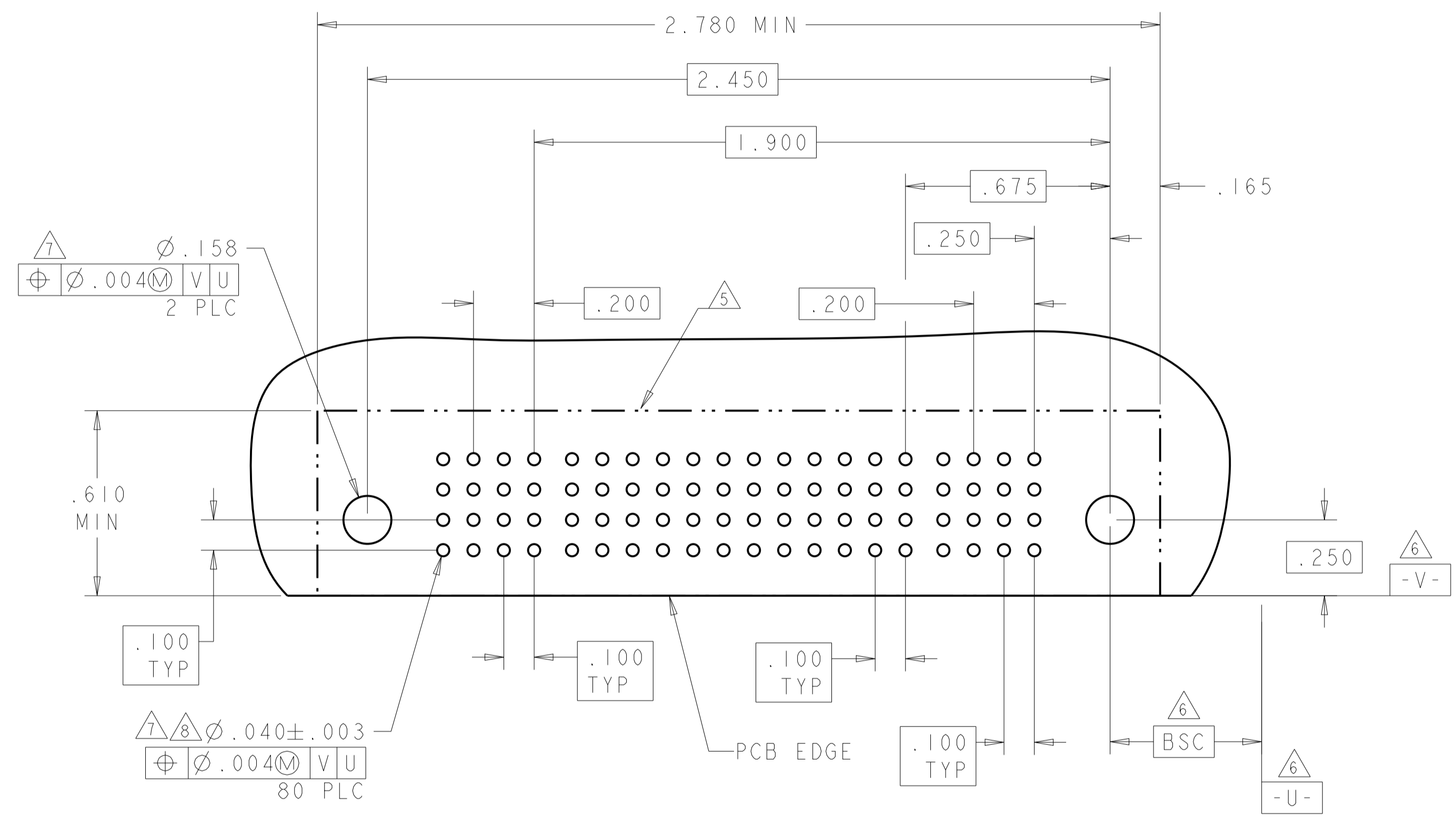

THIS DRAWING IS A CONTROLLED DOCUMENT.

DIMENSIONS:	TOLERANCES UNLESS OTHERWISE SPECIFIED:	OWN: R. GRZYBOWSKI / 08APROS	CHK: M. PERCHERKE / 08APROS	APVD: M. PERCHERKE	NAME: RIGHT ANGLE RECEPTACLE ASSEMBLY WITH GUIDES MULTI-BEAM XL
INCHES	0 PLC ±.01 2 PLC ±.01 3 PLC ±.005 4 PLC ±.002	PRODUCT SPEC: 108-1973	APPLICATION SPEC: 114-13038	SIZE: A1	CAGE CODE: 6450360
MATERIAL:	FINISH:	WEIGHT:	CUSTOMER DRAWING	SCALE: 4:1	SHEET 4 OF 6

4805 (3/13)

REVISIONS				
REV	DATE	BY	APPV	DESCRIPTION
-	-	-	-	SEE SHEET 1

PART NUMBER	ROWS	POWER		SIGNAL			POWER	
		P4	P3	3	2	1	P2	P1
6450360-7	D C B A	RA	RA	H	H	H	RA	RA
				G	G	G		
				F	F	F		
				E	E	E		
2P + 12S + 2P								

PART NUMBER	ROWS	POWER		SIGNAL										POWER					
		P6	P5	11	10	9	8	7	6	5	4	3	2	1	P5	P4	P3	P2	P1
1-6450360-5	D C B A	RM	RM	H	H	H	H	H	H	H	H	H	H	H	RM	RM	RM	RM	RM
				G	G	G													
				F	F	F	F	F	F	F	F	F	F	F					
				E	E	E	E	E	E	E	E	E	E	E					
5P + 44S + 1P																			

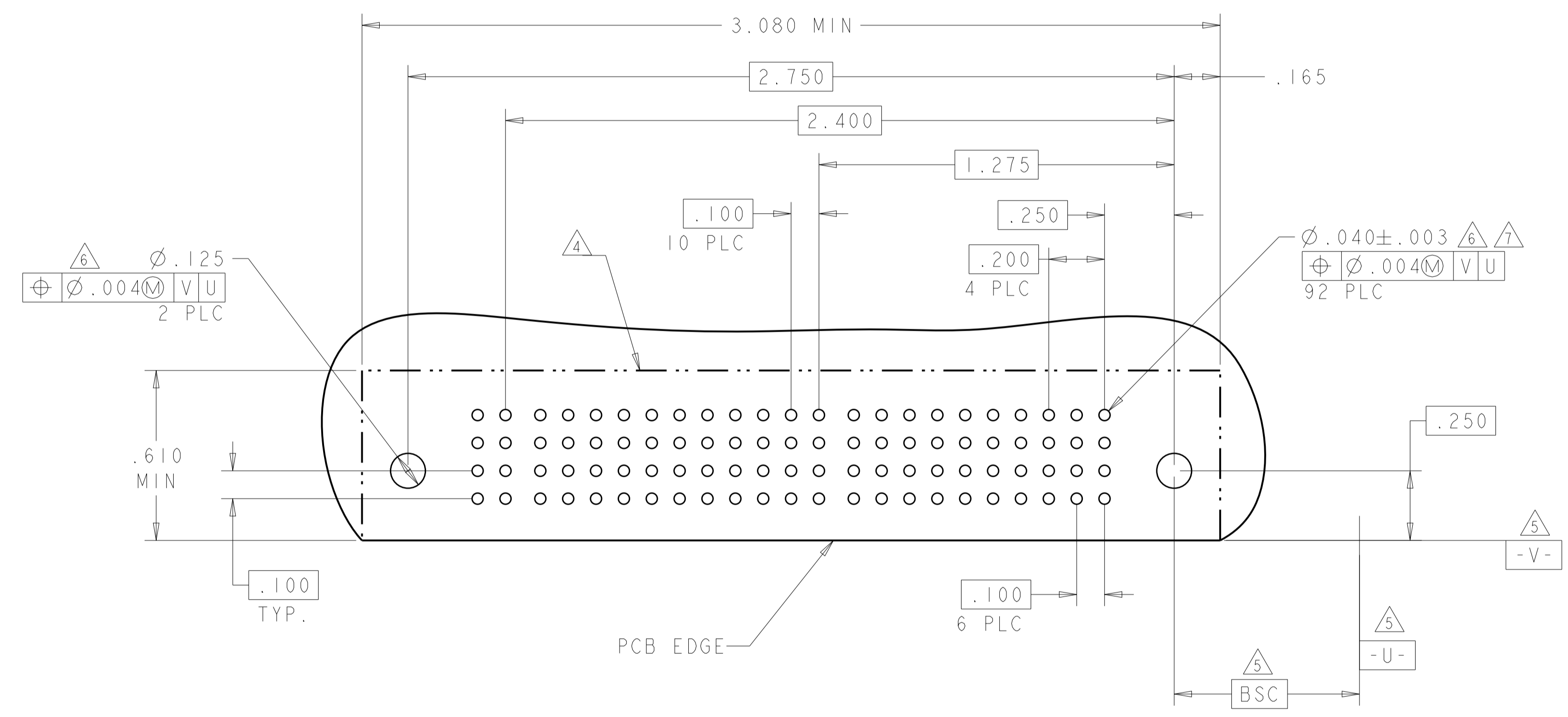
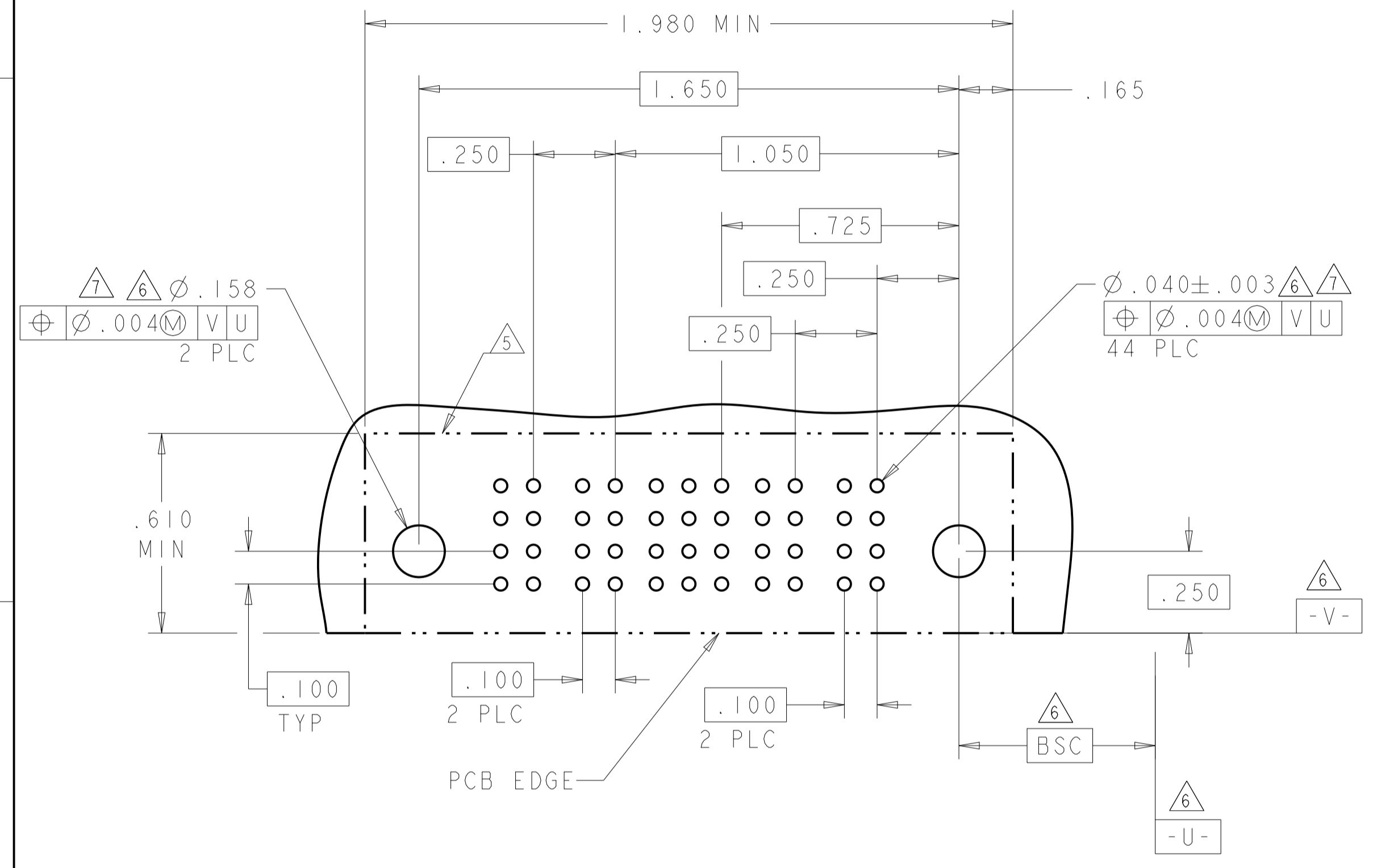

THIS DRAWING IS A CONTROLLED DOCUMENT.		OWN R. GRZYBOWSKI	08APROS	STE TE Connectivity
DIMENSIONS: INCHES		CHK M. PERCHERKE	08APROS	
TOLERANCES UNLESS OTHERWISE SPECIFIED:		APVD M. PERCHERKE	NAME	RIGHT ANGLE RECEPTACLE ASSEMBLY WITH GUIDES MULTI-BEAM XL
0 PLC ±.01		PRODUCT SPEC	108-1973	
2 PLC ±.01		APPLICATION SPEC	114-13038	RESTRICTED TO
3 PLC ±.005		WEIGHT	A100779C=6450360	SCALE 4:1 SHEET 5 OF 6 REV H5
4 PLC ±.0020		CUSTOMER DRAWING		
ANGLES ±.020				
FINISH				



Компания «ЭлектроПласт» предлагает заключение долгосрочных отношений при поставках импортных электронных компонентов на взаимовыгодных условиях!

Наши преимущества:

- Оперативные поставки широкого спектра электронных компонентов отечественного и импортного производства напрямую от производителей и с крупнейших мировых складов;
- Поставка более 17-ти миллионов наименований электронных компонентов;
- Поставка сложных, дефицитных, либо снятых с производства позиций;
- Оперативные сроки поставки под заказ (от 5 рабочих дней);
- Экспресс доставка в любую точку России;
- Техническая поддержка проекта, помощь в подборе аналогов, поставка прототипов;
- Система менеджмента качества сертифицирована по Международному стандарту ISO 9001;
- Лицензия ФСБ на осуществление работ с использованием сведений, составляющих государственную тайну;
- Поставка специализированных компонентов (Xilinx, Altera, Analog Devices, Intersil, Interpoint, Microsemi, Aeroflex, Peregrine, Syfer, Eurofarad, Texas Instrument, Miteq, Cobham, E2V, MA-COM, Hittite, Mini-Circuits, General Dynamics и др.);

Помимо этого, одним из направлений компании «ЭлектроПласт» является направление «Источники питания». Мы предлагаем Вам помощь Конструкторского отдела:

- Подбор оптимального решения, техническое обоснование при выборе компонента;
- Подбор аналогов;
- Консультации по применению компонента;
- Поставка образцов и прототипов;
- Техническая поддержка проекта;
- Защита от снятия компонента с производства.



Как с нами связаться

Телефон: 8 (812) 309 58 32 (многоканальный)

Факс: 8 (812) 320-02-42

Электронная почта: org@eplast1.ru

Адрес: 198099, г. Санкт-Петербург, ул. Калинина, дом 2, корпус 4, литера А.