

**Agency Approval**

Agency	Agency File Number
	L Package : E71639

**Schematic Symbol**

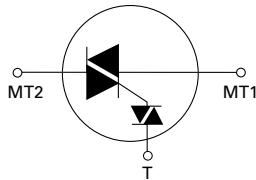

**Main Features**

Symbol	Value	Unit
$I_{T(RMS)}$	4 to 15	A
$V_{DRM} / V_{RRM}$	400 to 600	V
DIAC $V_{BO}$	33 to 43	V

**Description**

The Quadrac is an internally triggered Triac designed for AC switching and phase control applications. It is a Triac and DIAC in a single package, which saves user expense by eliminating the need for separate Triac and DIAC components.

Standard type devices normally operate in Quadrants I & III triggered from AC line.

Alternistor type Quadracs are used in circuits requiring high dv/dt capability.

**Features & Benefits**

- RoHS Compliant
- Glass – passivated junctions
- Voltage capability up to 600 V
- Surge capability up to 200 A

**Applications**

Excellent for AC switching and phase control applications such as lighting and heating. Typical applications are AC solid-state switches, light dimmers, power tools, home/ brown goods and white goods appliances.

Alternistor Quadracs (no snubber required) are used in applications with extremely inductive loads requiring highest commutation performance.

Internally constructed isolated package is offered for ease of heat sinking with highest isolation voltage.

**Absolute Maximum Ratings**

Symbol	Parameter	Value					Unit	
		Qxx04LT	Qxx06LT / Qxx06LTH	Qxx08LT / Qxx08LTH	Qxx10LT / Qxx10LTH	Qxx15LT / Qxx15LTH		
$I_{T(RMS)}$	RMS forward current	Qxx04LT: $T_C = 95^\circ\text{C}$ Qxx06LT/Qxx08LT/Qxx10LT: $T_C = 90^\circ\text{C}$ Qxx15LT: $T_C = 80^\circ\text{C}$					A	
$I_{TSM}$	Peak non-repetitive surge current	single half cycle; $f = 50\text{Hz}$ ; $T_J$ (initial) = $25^\circ\text{C}$	46	65	83	100	167	A
		single half cycle; $f = 60\text{Hz}$ ; $T_J$ (initial) = $25^\circ\text{C}$	55	80	100	120	200	
$I^2t$	$I^2t$ value for fusing	$t_p = 8.3\text{ms}$					$\text{A}^2\text{s}$	
$di/dt$	Critical rate-of-rise of on-state current	$f = 60\text{Hz}$ ; $T_J = 125^\circ\text{C}$					$\text{A}/\mu\text{s}$	
$I_{GM}$	Peak gate current	$T_J = 125^\circ\text{C}$					A	
$T_{stg}$	Storage temperature range	-40 to 150					$^\circ\text{C}$	
$T_J$	Operating junction temperature range	-40 to 125					$^\circ\text{C}$	

Note: xx = voltage

**Electrical Characteristics ( $T_J = 25^\circ\text{C}$ , unless otherwise specified) – Standard Quadrac**

Symbol	Test Conditions		Value					Unit	
			Qxx04LT	Qxx06LT	Qxx08LT	Qxx10LT	Qxx15LT		
$I_H$	$I_T = 200\text{mA}$ (initial)	MAX.	40	50	60	60	70	mA	
$dv/dt$	$V_D = V_{DRM}$ ; gate open; $T_J = 100^\circ\text{C}$	MIN.	400V	75	150	175	200	300	$\text{V}/\mu\text{s}$
			600V	50	125	150	175	200	
	$V_D = V_{DRM}$ ; gate open; $T_J = 125^\circ\text{C}$	MIN.	400V	50	100	120	150	200	
			600V	50	85	100	120	150	
$dv/dt(c)$	$di/dt(c) = 0.54 \times I_{T(RMS)} / \text{ms}$ ; $T_J = 125^\circ\text{C}$	MIN.	3	4				$\text{V}/\mu\text{s}$	
$t_{gt}$	(note 1)	TYP.	3				$\mu\text{s}$		

(1) Reference test circuit in figure 10 and waveform in figure 11;  $C_T = 0.1\mu\text{F}$  with  $0.1\mu\text{s}$  rise time.

Note: xx = voltage

**Electrical Characteristics ( $T_J = 25^\circ\text{C}$ , unless otherwise specified) – Alternistor Quadrac**

Symbol	Test Conditions		Value				Unit	
			Qxx06LTH	Qxx08LTH	Qxx10LTH	Qxx15LTH		
$I_H$	$I_T = 20\text{mA}$ (initial)	MAX.	50	50	60	70	mA	
$dv/dt$	$V_D = V_{DRM}$ ; gate open; $T_J = 100^\circ\text{C}$	MIN.	400V	575		925		$\text{V}/\mu\text{s}$
			600V	425		775		
	$V_D = V_{DRM}$ ; gate open; $T_J = 125^\circ\text{C}$	MIN.	400V	450		700		
			600V	350		600		
$dv/dt(c)$	$di/dt(c) = 0.54 \times I_{T(RMS)} / \text{ms}$ ; $T_J = 125^\circ\text{C}$	MIN.	25		30		$\text{V}/\mu\text{s}$	
$t_{gt}$	(note 1)	TYP.	3			$\mu\text{s}$		

(1) Reference test circuit in figure 10 and waveform in figure 11;  $C_T = 0.1\mu\text{F}$  with  $0.1\mu\text{s}$  rise time.

Note: xx = voltage

### Trigger DIAC Specifications

Symbol	Test Conditions		Value	Unit
$\Delta V_{BO}$	Breakover Voltage Symmetry	MAX.	3	V
$V_{BO}$	Breakover Voltage, forward and reverse	MIN.	33	V
		MAX.	43	
$[\Delta V_{\pm}]$	Dynamic Breakback Voltage, forward and reverse (note 1)	MIN.	5	V
$I_{BO}$	Peak Breakover Current	MAX.	25	$\mu A$
$C_T$	Trigger Firing Capacitance	MAX.	0.1	$\mu F$

(1) Reference test circuit in figure 10 and waveform in figure 11.

### Static Characteristics

Symbol	Test Conditions		Value	Unit	
$V_{TM}$	$I_T = 1.41 \times I_{T( rms )} A; t_p = 380 \mu s$	MAX.	1.6	V	
$I_{DRM} / I_{RRM}$	$V_{DRM} / V_{RRM}$	$T_J = 25^{\circ}C$	MAX.	10	$\mu A$
		$T_J = 100^{\circ}C$		500	
		$T_J = 125^{\circ}C$		2000	

### Thermal Resistances

Symbol	Parameter		Value	Unit
$R_{\theta(J-C)}$	Junction to case (AC)	Qxx04LT	3.6	$^{\circ}C/W$
		Qxx06LT / Qxx06LTH	3.3	
		Qxx08LT / Qxx08LTH	2.8	
		Qxx10LT / Qxx10LTH	2.6	
		Qxx15LT / Qxx15LTH	2.1	
$R_{\theta(J-A)}$	Junction to ambient		50	$^{\circ}C/W$

Note : xx = voltage

**Figure 1: Normalized DC Holding Current vs. Junction Temperature**

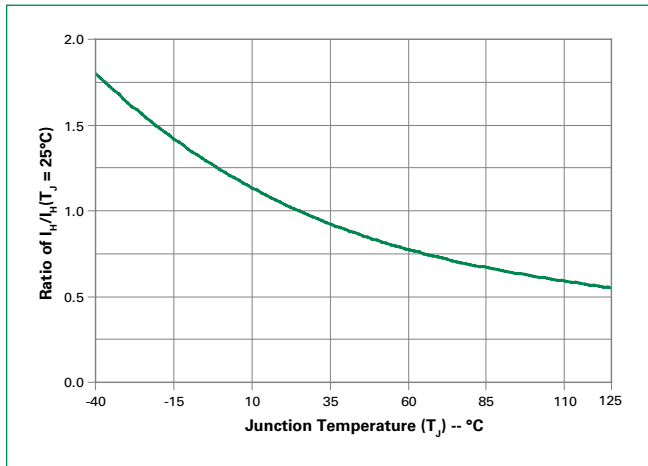

**Figure 2: On-State Current vs. On-State Voltage (Typical) (4A)**

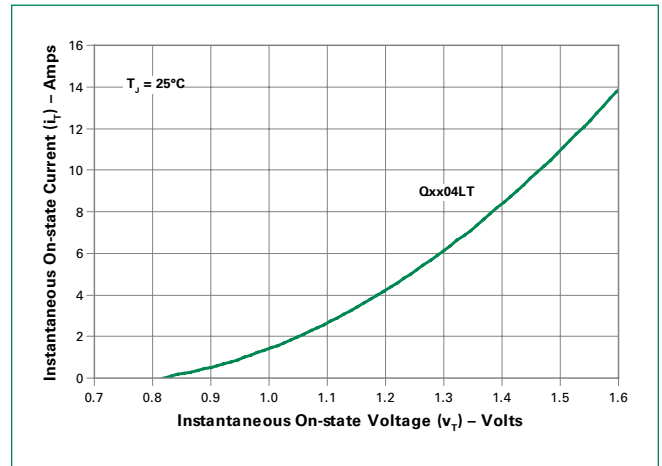

**Figure 3: On-State Current vs. On-State Voltage (Typical) (6A to 15A)**

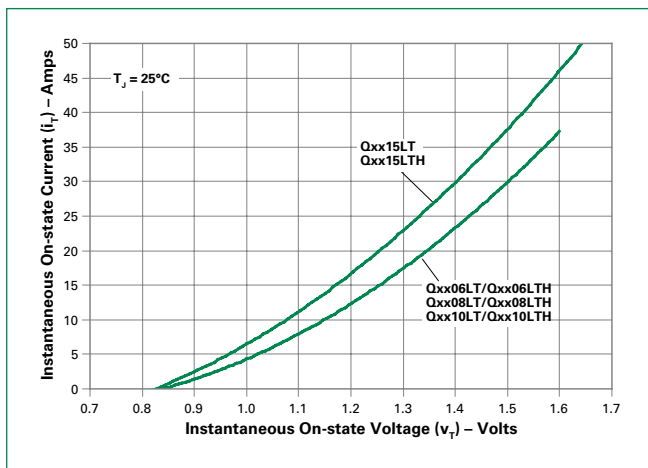

**Figure 4: Power Dissipation vs. RMS On-State Current (Typical) (4A)**

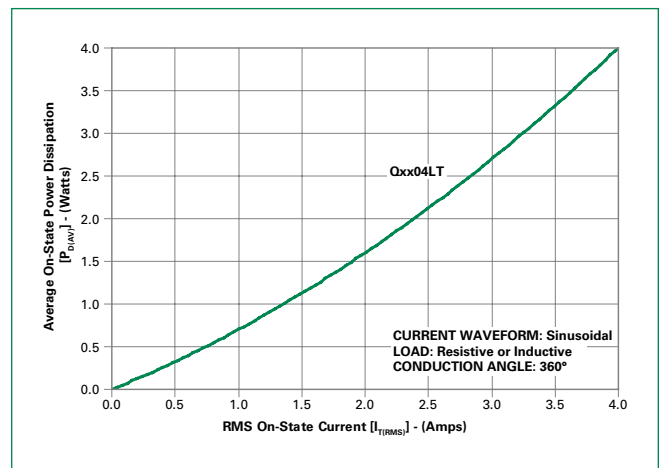

**Figure 5: Power Dissipation vs. RMS On-State Current (Typical) (6A to 15A)**

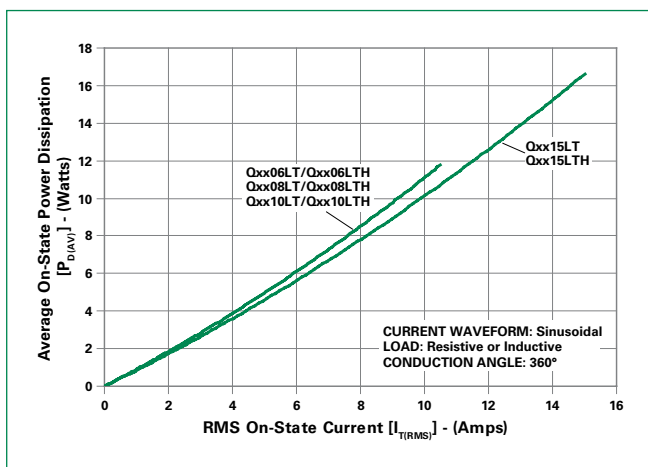

**Figure 6: Maximum Allowable Case Temperature vs. RMS On-State Current**

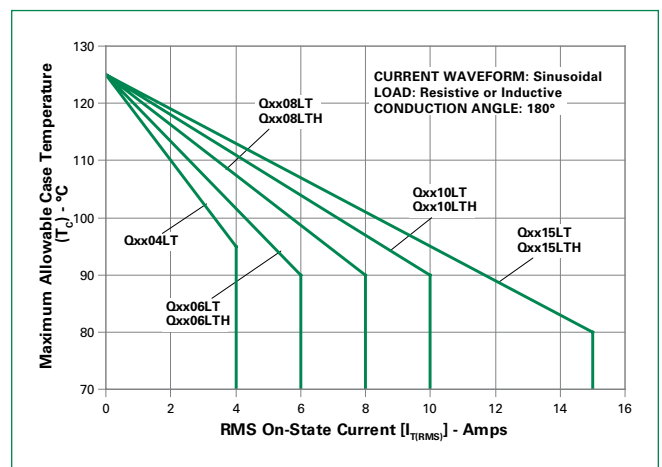

Figure 7: Surge Peak On-State Current vs. Number of Cycles



Note: xx = voltage

Figure 8: DIAC  $V_{BO}$  Change vs. Junction Temperature

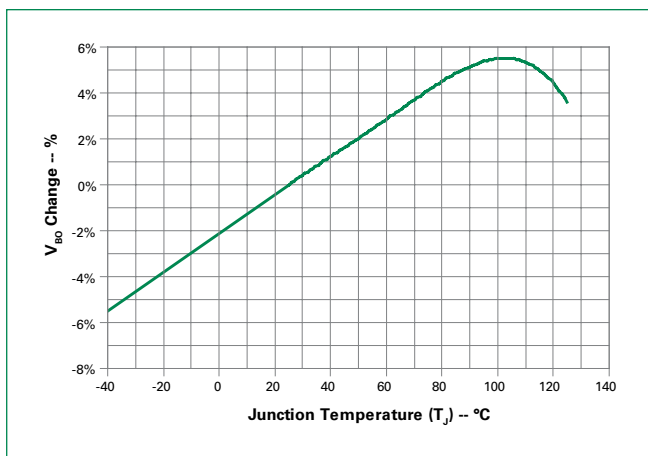

Figure 9: Test Circuit

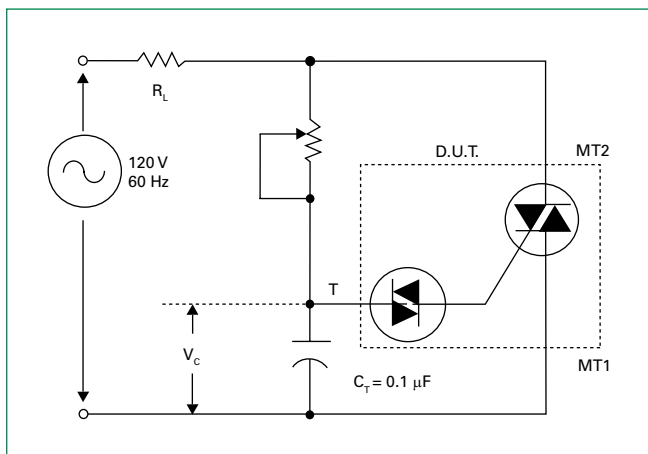
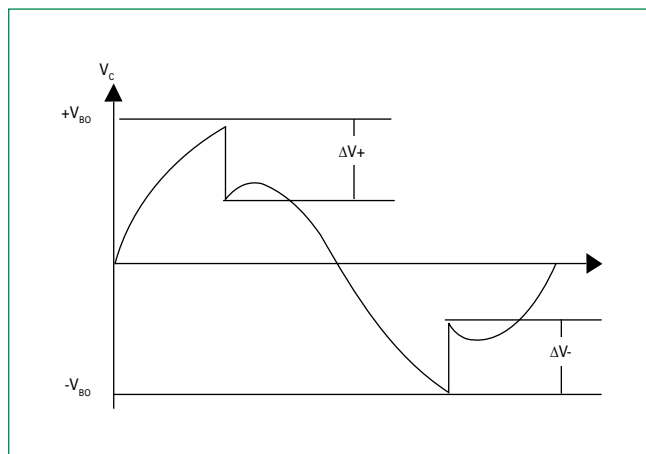

Figure 10: Test Circuit Waveform



### Soldering Parameters

Reflow Condition		Pb – Free assembly
Pre Heat	- Temperature Min ( $T_{s(min)}$ )	150°C
	- Temperature Max ( $T_{s(max)}$ )	200°C
	- Time (min to max) ( $t_s$ )	60 – 180 secs
Average ramp up rate (Liquidus Temp ( $T_L$ ) to peak)		5°C/second max
$T_{s(max)}$ to $T_L$ - Ramp-up Rate		5°C/second max
Reflow	- Temperature ( $T_L$ ) (Liquidus)	217°C
	- Temperature ( $t_L$ )	60 – 150 seconds
Peak Temperature ( $T_p$ )		260°C <sup>+0/-5</sup>
Time within 5°C of actual peak Temperature ( $t_p$ )		20 – 40 seconds
Ramp-down Rate		5°C/second max
Time 25°C to peak Temperature ( $T_p$ )		8 minutes Max.
Do not exceed		280°C



### Physical Specifications

<b>Terminal Finish</b>	1005 Matte Tin-plated
<b>Body Material</b>	UL Recognized epoxy meeting flammability classification 94v-0
<b>Lead Material</b>	Copper Alloy

### Design Considerations

Careful selection of the correct device for the application's operating parameters and environment will go a long way toward extending the operating life of the Thyristor. Good design practice should limit the maximum continuous current through the main terminals to 75% of the device rating. Other ways to ensure long life for a power discrete semiconductor are proper heat sinking and selection of voltage ratings for worst case conditions. Overheating, overvoltage (including dv/dt), and surge currents are the main killers of semiconductors. Correct mounting, soldering, and forming of the leads also help protect against component damage.

### Environmental Specifications

Test	Specifications and Conditions
<b>High Temperature Voltage Blocking</b>	MIL-STD-750: Method 1040, Condition A Rated $V_{DRM}$ (VAC-peak), 125°C, 1008 hours
<b>Temperature Cycling</b>	MIL-STD-750: Method 1051 -40°C to 150°C, 15-minute dwell, 100 cycles
<b>Biased Temperature &amp; Humidity</b>	EIA/JEDEC: JESD22-A101 320VDC, 85°C, 85%RH, 1008 hours
<b>High Temp Storage</b>	MIL-STD-750: Method 1031 150°C, 1008 hours
<b>Low-Temp Storage</b>	-40°C, 1008 hours
<b>Thermal Shock</b>	MIL-STD-750: Method 1056 0°C to 100°C, 5-minute dwell, 10-second transfer, 10 cycles
<b>Autoclave (Pressure Cooker Test)</b>	EIA/JEDEC: JESD22-A102 121°C, 100%RH, 2atm, 168 hours
<b>Resistance to Solder Heat</b>	MIL-STD-750: Method 2031 260°C, 10 seconds
<b>Solderability</b>	ANSI/J-STD-002, Category 3, Test A
<b>Lead Bend</b>	MIL-STD-750: Method 2036, Condition E

**Dimensions — TO-220AB (L-Package) — Isolated Mounting Tab**

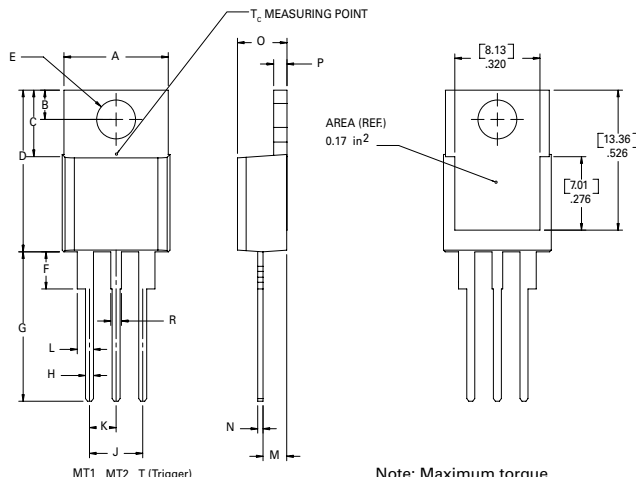

Dimension	Inches		Millimeters	
	Min	Max	Min	Max
A	0.380	0.420	9.65	10.67
B	0.105	0.115	2.67	2.92
C	0.230	0.250	5.84	6.35
D	0.590	0.620	14.99	15.75
E	0.142	0.147	3.61	3.73
F	0.110	0.130	2.79	3.30
G	0.540	0.575	13.72	14.61
H	0.025	0.035	0.64	0.89
J	0.195	0.205	4.95	5.21
K	0.095	0.105	2.41	2.67
L	0.060	0.075	1.52	1.91
M	0.085	0.095	2.16	2.41
N	0.018	0.024	0.46	0.61
O	0.178	0.188	4.52	4.78
P	0.045	0.060	1.14	1.52
R	0.038	0.048	0.97	1.22

**Product Selector**

Part Number	Voltage				Type	Package
	400V	600V	800V	1000V		
Qxx04LT	X	X			Quadrac	TO-220L
Qxx06LT	X	X			Quadrac	TO-220L
Qxx06LTH	X	X			Alternistor Quadrac	TO-220L
Qxx08LT	X	X			Quadrac	TO-220L
Qxx08LTH	X	X			Alternistor Quadrac	TO-220L
Qxx10LT	X	X			Quadrac	TO-220L
Qxx10LTH	X	X			Alternistor Quadrac	TO-220L
Qxx15LT	X	X			Quadrac	TO-220L
Qxx15LTH	X	X			Alternistor Quadrac	TO-220L

Note: xx = Voltage

**Packing Options**

Part Number	Marking	Weight	Packing Mode	Base Quantity
Qxx04LT	Qxx04LT	2.2 g	Bulk	500
Qxx04LTTP	Qxx04LT	2.2 g	Tube	500 (50 per tube)
Qxx06LT	Qxx06LT	2.2 g	Bulk	500
Qxx06LTTP	Qxx06LT	2.2 g	Tube	500 (50 per tube)
Qxx06LTH	Qxx06LTH	2.2 g	Bulk	500
Qxx06LTHTP	Qxx06LTH	2.2 g	Tube	500 (50 per tube)
Qxx08LT	Qxx08LT	2.2 g	Bulk	500
Qxx08LTTP	Qxx08LT	2.2 g	Tube	500 (50 per tube)
Qxx08LTH	Qxx08LTH	2.2 g	Bulk	500
Qxx08LTHTP	Qxx08LTH	2.2 g	Tube	500 (50 per tube)
Qxx10LT	Qxx10LT	2.2 g	Bulk	500
Qxx10LTTP	Qxx10LT	2.2 g	Tube	500 (50 per tube)
Qxx10LTH	Qxx10LTH	2.2 g	Bulk	500
Qxx10LTHTP	Qxx10LTH	2.2 g	Tube	500 (50 per tube)
Qxx15LT	Qxx15LT	2.2 g	Bulk	500
Qxx15LTTP	Qxx15LT	2.2 g	Tube	500 (50 per tube)
Qxx15LTH	Qxx15LTH	2.2 g	Bulk	500
Qxx15LTHTP	Qxx15LTH	2.2 g	Tube	500 (50 per tube)

Note: xx = Voltage

**Part Numbering System**



**Part Marking System**

TO-220 AB – (L Package)







Компания «ЭлектроПласт» предлагает заключение долгосрочных отношений при поставках импортных электронных компонентов на взаимовыгодных условиях!

Наши преимущества:

- Оперативные поставки широкого спектра электронных компонентов отечественного и импортного производства напрямую от производителей и с крупнейших мировых складов;
- Поставка более 17-ти миллионов наименований электронных компонентов;
- Поставка сложных, дефицитных, либо снятых с производства позиций;
- Оперативные сроки поставки под заказ (от 5 рабочих дней);
- Экспресс доставка в любую точку России;
- Техническая поддержка проекта, помощь в подборе аналогов, поставка прототипов;
- Система менеджмента качества сертифицирована по Международному стандарту ISO 9001;
- Лицензия ФСБ на осуществление работ с использованием сведений, составляющих государственную тайну;
- Поставка специализированных компонентов (Xilinx, Altera, Analog Devices, Intersil, Interpoint, Microsemi, Aeroflex, Peregrine, Syfer, Eurofarad, Texas Instrument, Miteq, Cobham, E2V, MA-COM, Hittite, Mini-Circuits, General Dynamics и др.);

Помимо этого, одним из направлений компании «ЭлектроПласт» является направление «Источники питания». Мы предлагаем Вам помощь Конструкторского отдела:

- Подбор оптимального решения, техническое обоснование при выборе компонента;
- Подбор аналогов;
- Консультации по применению компонента;
- Поставка образцов и прототипов;
- Техническая поддержка проекта;
- Защита от снятия компонента с производства.



#### Как с нами связаться

**Телефон:** 8 (812) 309 58 32 (многоканальный)

**Факс:** 8 (812) 320-02-42

**Электронная почта:** [org@eplast1.ru](mailto:org@eplast1.ru)

**Адрес:** 198099, г. Санкт-Петербург, ул. Калинина, дом 2, корпус 4, литера А.