

CGH40180PP

180 W, RF Power GaN HEMT

Cree's CGH40180PP is an unmatched, gallium nitride (GaN) high electron mobility transistor (HEMT). The CGH40180PP, operating from a 28 volt rail, offers a general purpose, broadband solution to a variety of RF and microwave applications. GaN HEMTs offer high efficiency, high gain and wide bandwidth capabilities making the CGH40180PP ideal for linear and compressed amplifier circuits. The transistor is available in a 4-lead flange package.

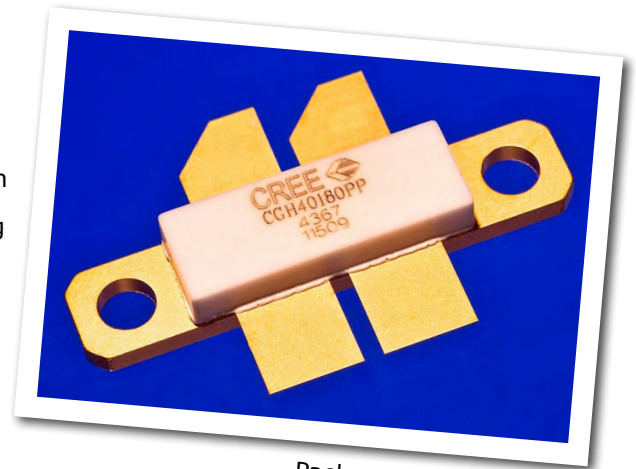

Package Types: 440199
PN: CGH40180PP

FEATURES

- Up to 2.5 GHz Operation
- 20 dB Small Signal Gain at 1.0 GHz
- 15 dB Small Signal Gain at 2.0 GHz
- 220 W typical P_{SAT}
- 70 % Efficiency at P_{SAT}
- 28 V Operation

APPLICATIONS

- 2-Way Private Radio
- Broadband Amplifiers
- Cellular Infrastructure
- Test Instrumentation
- Class A, AB, Linear amplifiers suitable for OFDM, W-CDMA, EDGE, CDMA waveforms





Absolute Maximum Ratings (not simultaneous) at 25 °C Case Temperature

Parameter	Symbol	Rating	Units	Conditions
Drain-Source Voltage	V_{DSS}	84	Volts	25 °C
Gate-to-Source Voltage	V_{GS}	-10, +2	Volts	25 °C
Storage Temperature	T_{STG}	-65, +150	°C	
Operating Junction Temperature	T_J	225	°C	
Maximum Forward Gate Current	I_{GMAX}	60	mA	25 °C
Maximum Drain Current ¹	I_{DMAX}	24	A	25 °C
Soldering Temperature ²	T_S	245	°C	
Screw Torque	τ	80	in-oz	
Thermal Resistance, Junction to Case ³	$R_{\theta JC}$	0.9	°C/W	85 °C
Case Operating Temperature ^{3,4}	T_C	-40, +150	°C	30 seconds

Note:

¹ Current limit for long term, reliable operation

² Refer to the Application Note on soldering at www.cree.com/products/wireless_appnotes.asp

³ CGH40180PP at $P_{DISS} = 224$ W.

⁴ See also, the Power Dissipation De-rating Curve on Page 6.

Electrical Characteristics ($T_C = 25$ °C)

Characteristics	Symbol	Min.	Typ.	Max.	Units	Conditions
DC Characteristics¹						
Gate Threshold Voltage	$V_{GS(th)}$	-3.8	-3.0	-2.3	V_{DC}	$V_{DS} = 10$ V, $I_D = 57.6$ mA
Gate Quiescent Voltage	$V_{GS(Q)}$	-	-2.7	-	V_{DC}	$V_{DS} = 28$ V, $I_D = 2.0$ A
Saturated Drain Current ²	I_{DS}	46.4	56.0	-	A	$V_{DS} = 6.0$ V, $V_{GS} = 2.0$ V
Drain-Source Breakdown Voltage	V_{BR}	120	-	-	V_{DC}	$V_{GS} = -8$ V, $I_D = 57.6$ mA
RF Characteristics^{3,4} ($T_C = 25$ °C, $F_0 = 1.3$ GHz unless otherwise noted)						
Small Signal Gain	G_{SS}	17.5	19	-	dB	$V_{DD} = 28$ V, $I_{DQ} = 2.0$ A
Power Output at Saturation ⁵	P_{SAT}	180	220	-	W	$V_{DD} = 28$ V, $I_{DQ} = 2.0$ A
Drain Efficiency ⁶	η	50	65	-	%	$V_{DD} = 28$ V, $I_{DQ} = 2.0$ A, $P_{OUT} = P_{SAT}$
Output Mismatch Stress	VSWR	-	-	10 : 1	Ψ	No damage at all phase angles, $V_{DD} = 28$ V, $I_{DQ} = 2.0$ A, $P_{OUT} = 180$ W CW
Dynamic Characteristics⁷						
Input Capacitance	C_{GS}	-	35.7	-	pF	$V_{DS} = 28$ V, $V_{gs} = -8$ V, $f = 1$ MHz
Output Capacitance	C_{DS}	-	9.6	-	pF	$V_{DS} = 28$ V, $V_{gs} = -8$ V, $f = 1$ MHz
Feedback Capacitance	C_{GD}	-	1.6	-	pF	$V_{DS} = 28$ V, $V_{gs} = -8$ V, $f = 1$ MHz

Notes:

¹ Measured on wafer prior to packaging.

² Scaled from PCM data.

³ Measured in CGH40180PP-TB, including all coupler losses.

⁴ I_{DQ} of 2.0 A is by biasing each device at 1.0 A.

⁵ P_{SAT} is defined as: Q1 or Q2 = $I_G = 2.8$ mA.

⁶ Drain Efficiency = P_{OUT} / P_{DC}

⁷ Capacitance values are for each side of the device.

Typical Performance

Gain and Return Loss vs Frequency of the CGH40180PP measured in Broadband Amplifier Circuit CGH40180PP-TB
 $V_{DD} = 28\text{ V}$, $I_{DQ} = 2.0\text{ A}$, Freq = 0.8 - 1.7 GHz

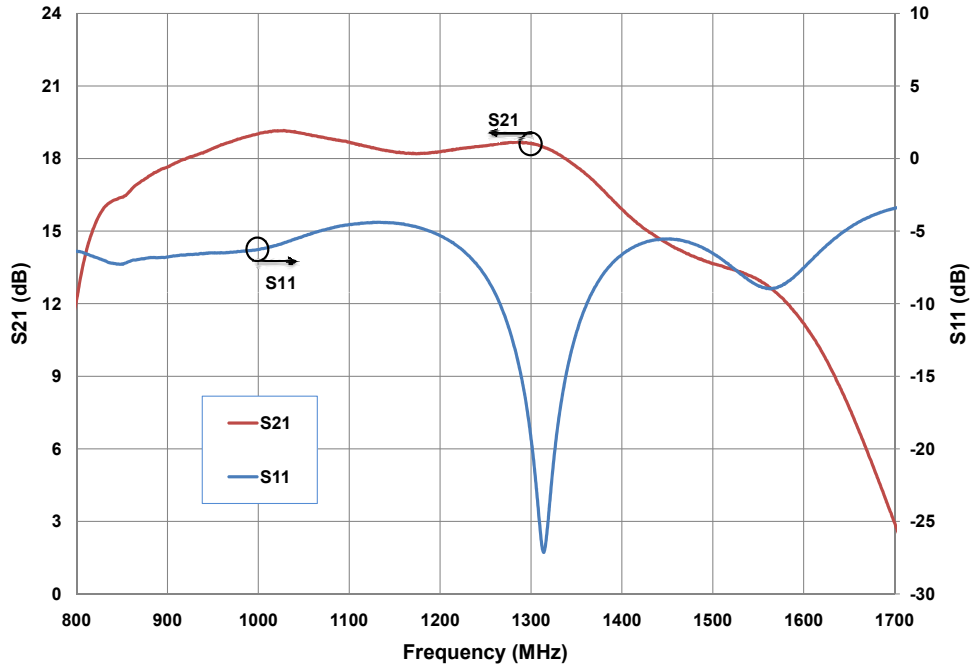

Output Power and Drain Efficiency vs Frequency of the CGH40180PP measured in Broadband Amplifier Circuit CGH40180PP-TB
 $V_{DD} = 28\text{ V}$, $I_{DQ} = 2.0\text{ A}$

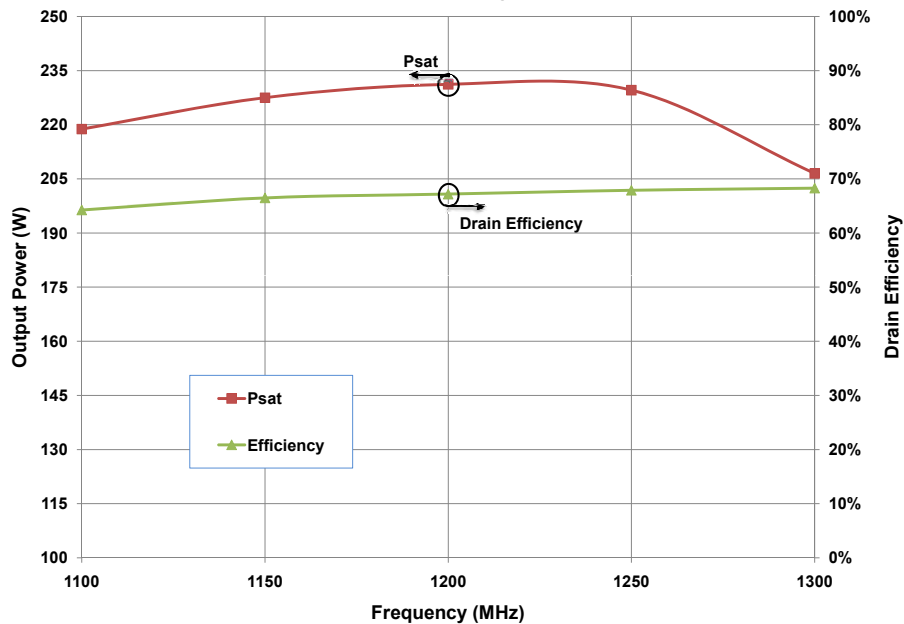



Typical Performance

**Gain and Drain Efficiency vs Output Power of the CGH40180PP
in Broadband Amplifier Circuit CGH40180PP-TB**
 $V_{DD} = 28 \text{ V}, I_{DQ} = 2.0 \text{ A}$

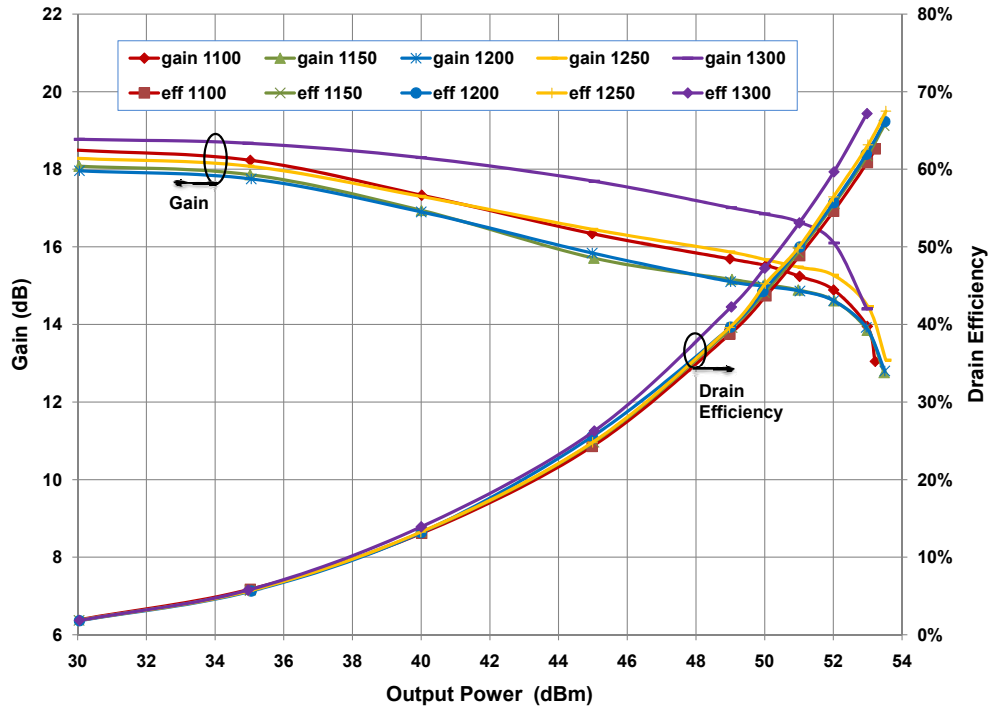

Typical Performance

Simulated Maximum Available Gain and K Factor of the CGH40180PP

$V_{DD} = 28\text{ V}, I_{DQ} = 1.0\text{ A}$

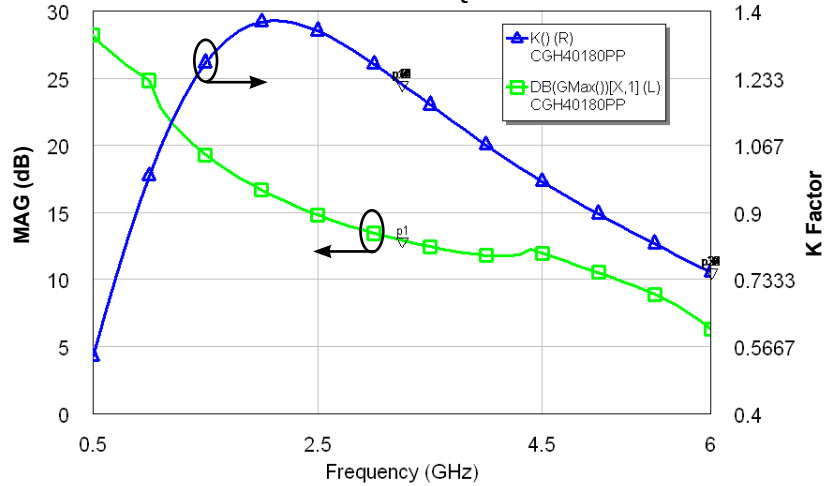

Typical Noise Performance

Simulated Minimum Noise Figure and Noise Resistance vs Frequency of the CGH40180PP

$V_{DD} = 28\text{ V}, I_{DQ} = 1\text{ A}$

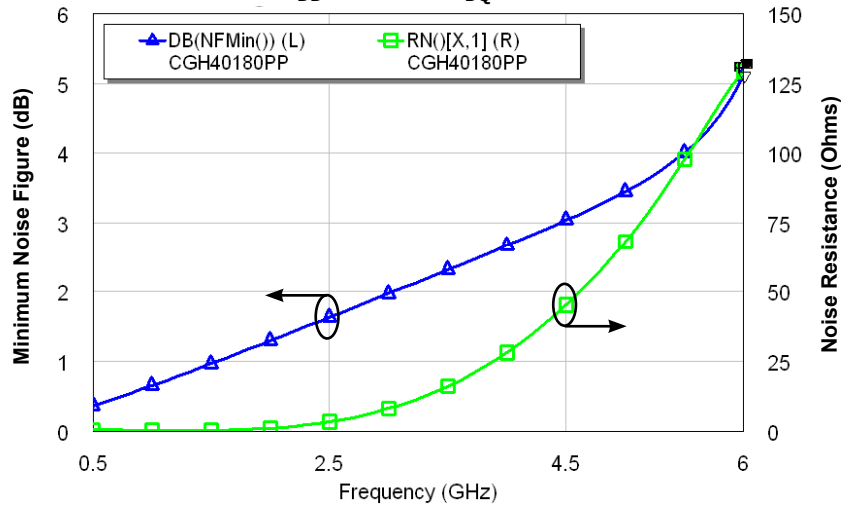

Electrostatic Discharge (ESD) Classifications

Parameter	Symbol	Class	Test Methodology
Human Body Model	HBM	1A > 250 V	JEDEC JESD22 A114-D
Charge Device Model	CDM	1 < 200 V	JEDEC JESD22 C101-C



CGH40180PP Power Dissipation De-rating Curve

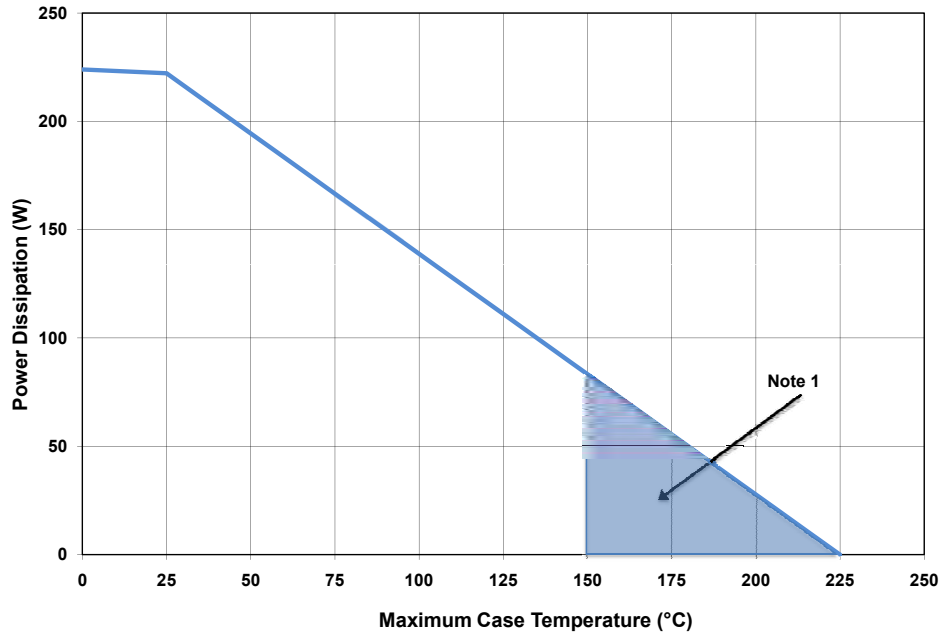

Note 1. Area exceeds Maximum Case Operating Temperature (See Page 2).

CGH40180PP Transient Power Dissipation De-rating Curve

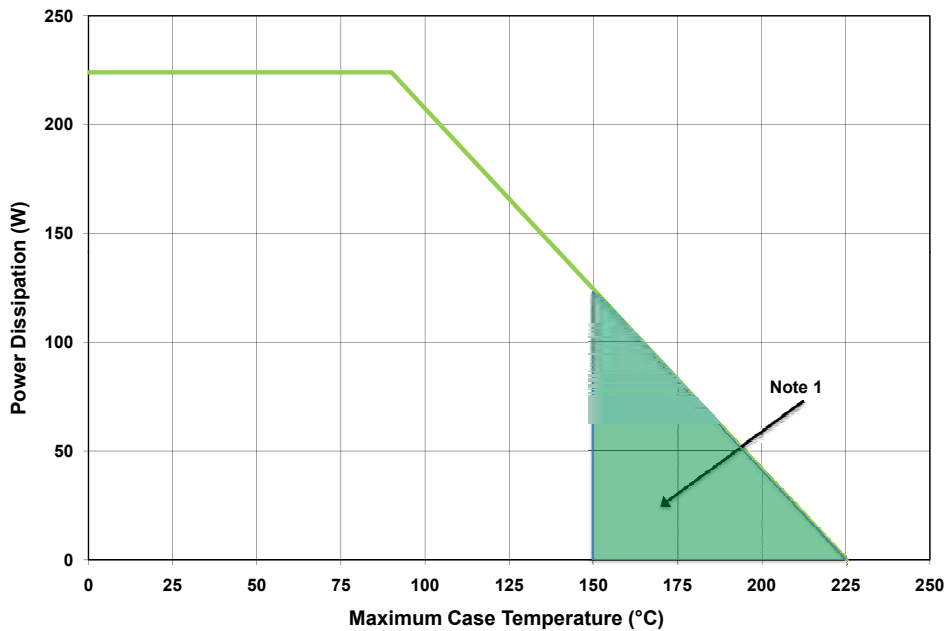

Note 1. Area exceeds Maximum Case Operating Temperature (See Page 2).

Note 2. This transient de-rating curve assumes a 1msec pulse with a 20% duty cycle with no power dissipated during the "off-cycle."

Thermal Resistance as a Function of Pulse Width

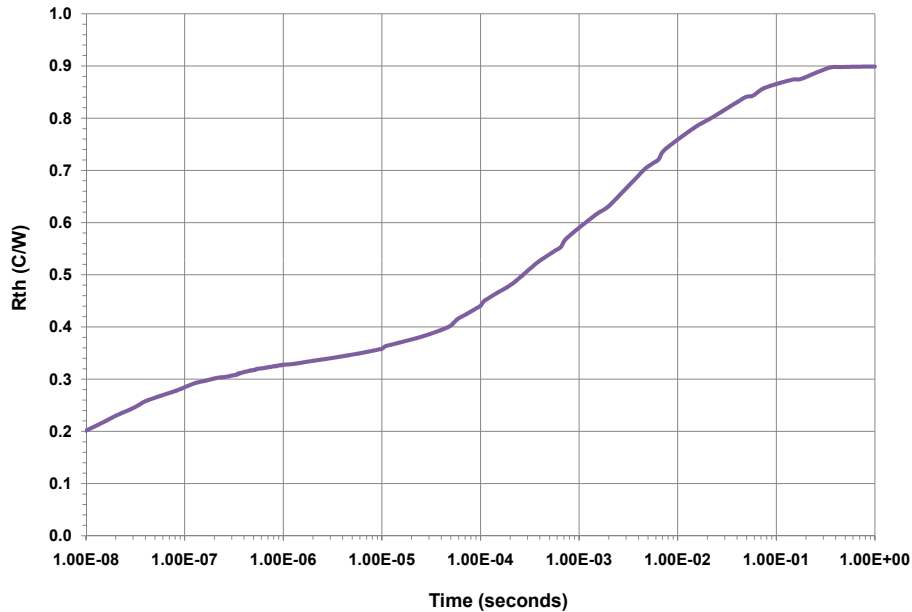

Note 1: This heating curve assumes zero power dissipation during the "off" portion of the duty cycle.

Note 2: This data is for transient power dissipation at 224 W, Duty Cycle = 20 %.

Simulated Source and Load Impedances

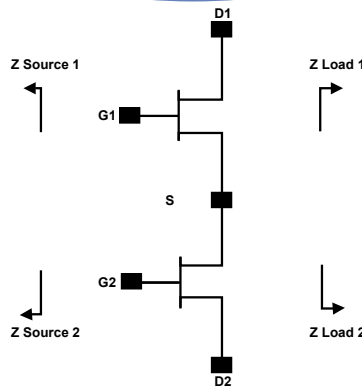

Frequency (MHz)	Z Source	Z Load
500	2.85 + j1.99	5.27 + j0.68
1000	0.8 + j0.42	4.91 + j0.36
1500	0.84 - j1.69	4.65 - j0.24
2000	0.88 - j3.05	2.8 - j1.05
2500	1.08 - j4.5	3.1 - j2.47
3000	1.25 - j6.06	3.1 - j4.01

Note 1. $V_{DD} = 28V$, $I_{DQ} = 2.0 A$ in the 440199 package.

Note 2. Optimized for power gain, P_{SAT} and PAE.

Note 3. When using this device at low frequency, series resistors should be used to maintain amplifier stability.

CGH40180PP-TB Demonstration Amplifier Circuit Schematic

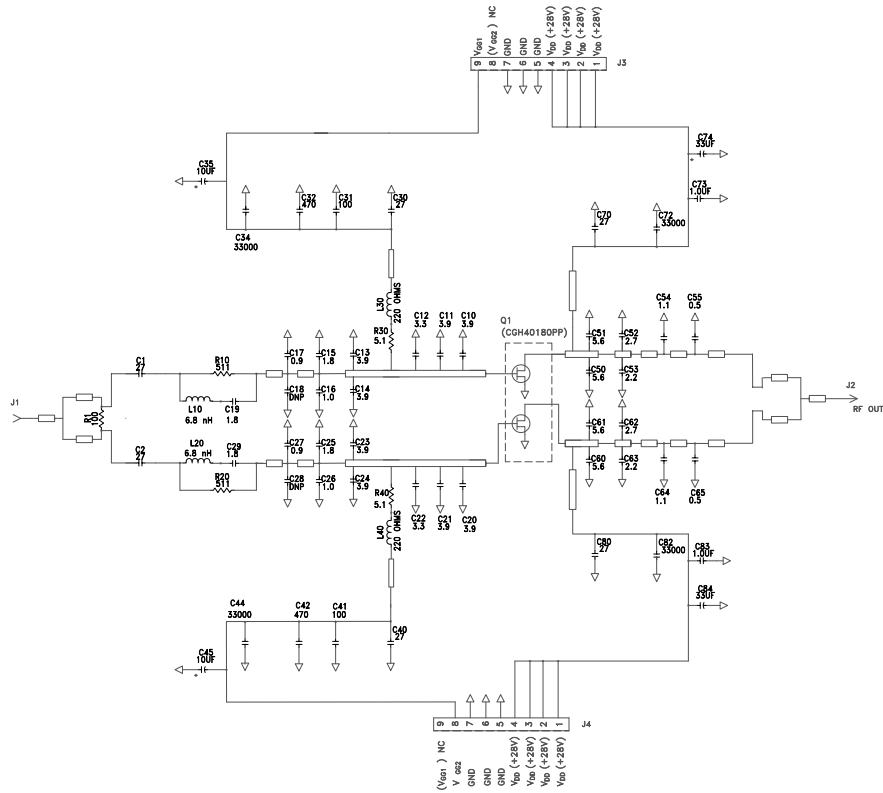

CGH40180PP-TB Demonstration Amplifier Circuit Outline

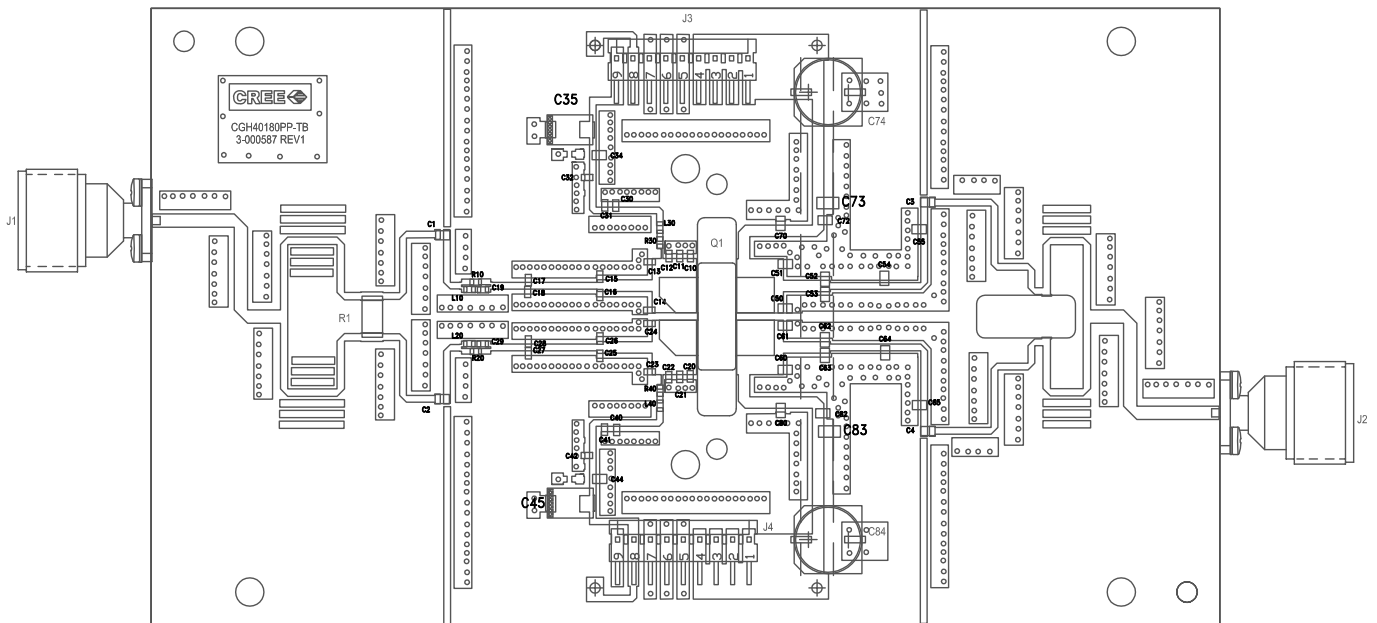

CGH40180PP-TB Demonstration Amplifier Circuit Bill of Materials

Designator	Description	Qty
R1	RES, 100 Ohm, +/-1%, 1 W, 2512	1
R10,R20	RES, 511 Ohm, +/- 5%, 1/16W, 0603	2
R30,R40	RES, 1/16W, 0603, 1%, 5.1 OHMS	2
C1,C2,C3,C4,C30,C40,C70,C80	CAP, 27 pF,+/-5% 0805,ATC600F	8
C10,C11,C13,C14,C20,C21,C23,C24	CAP, 3.9PF, +/-0.1 pF, 0603, ATC600S	8
C12,C22	CAP, 3.3PF, +/-0.1 pF, 0603, ATC600S	2
C15,C19,C25,C29	CAP, 1.8PF, +/-0.1 pF, 0603, ATC600S	4
C16,C26	CAP, 1.0PF, +/-0.1 pF, 0603, ATC600S	2
C17,C27	CAP, 0.9PF, +/-0.1 pF, 0603, ATC600S	2
C31,C41	CAP, 100 pF,+/-5%, 0603,ATC600S	2
C32,C42	CAP, 470 pF, 5%, 100V, 0603, X7R	2
C34,C44,C72,C82	CAP, 33000 pF, 0805, 100V, X7R	4
C35,C45	CAP, 10 uF, 16V, TANTALUM	2
C50,C51,C60,C61	CAP, 5.6 pF, +/-0.1 pF, 0805, ATC600F	4
C52,C62	CAP, 2.7 pF, +/-0.1 pF, 0805, ATC600F	2
C53,C63	CAP, 2.2 pF, +/-0.1 pF, 0805, ATC600F	2
C54,C64	CAP, 1.1 pF, +/-0.05 pF, 0805, ATC600F	2
C55,C65	CAP, 0.5 pF, +/-0.05 pF, 0805, ATC600F	2
C73,C83	CAP, 1.0 uF, +/-10%, 1210, 100V, X7R	2
C74,C84	CAP, 33 uF, 100V, ELECT, FK, SMD	2
L10,L20	IND, 6.8 nH, 0603, L-14C6N8ST	2
L30,L40	FERRITE, 220 OHM, 0603, BLM21PG221SN1	2
J1,J2	CONN, N-Type, Female, 0.500 SMA Flange	2
J3,J4	CONN, Header, RT> PLZ, 0.1 CEN, LK, 9 POS	2
-	PCB, RO4350, Er = 3.48, h = 20 mil	1
Q1	CGH40180PP	1

CGH40180PP-TB Demonstration Amplifier Circuit

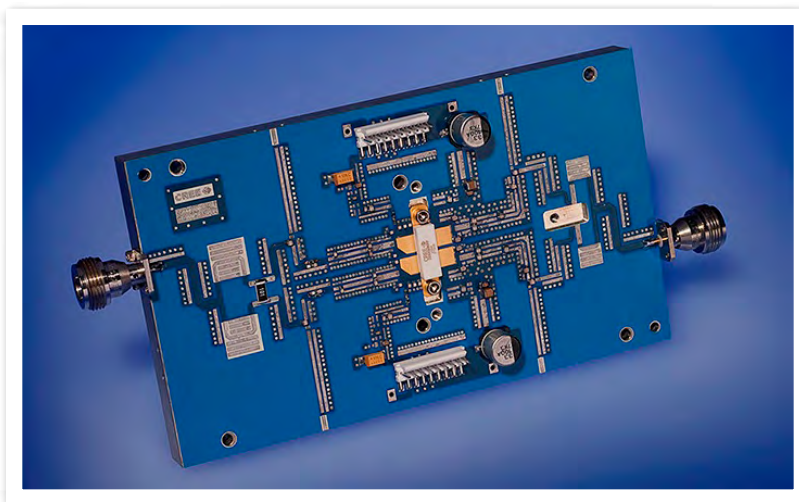



**Typical Package S-Parameters for CGH40180PP, Single Side
(Small Signal, $V_{DS} = 28\text{ V}$, $I_{DQ} = 1000\text{ mA}$, angle in degrees)**

Frequency	Mag S11	Ang S11	Mag S21	Ang S21	Mag S12	Ang S12	Mag S22	Ang S22
500 MHz	0.957	-177.48	4.22	79.26	0.007	10.74	0.798	-179.16
600 MHz	0.957	-178.74	3.51	76.30	0.007	12.14	0.800	-179.41
700 MHz	0.957	-179.78	3.00	73.47	0.007	13.71	0.802	-179.63
800 MHz	0.957	179.32	2.62	70.74	0.007	15.38	0.804	-179.84
900 MHz	0.957	178.51	2.33	68.08	0.007	17.15	0.807	179.96
1.0 GHz	0.957	177.76	2.09	65.49	0.007	18.99	0.809	179.74
1.1 GHz	0.957	177.06	1.90	62.95	0.007	20.87	0.812	179.52
1.2 GHz	0.957	176.38	1.73	60.46	0.007	22.80	0.814	179.28
1.3 GHz	0.957	175.72	1.60	58.02	0.008	24.73	0.817	179.03
1.4 GHz	0.956	175.08	1.48	55.63	0.008	26.66	0.820	178.76
1.5 GHz	0.956	174.44	1.38	53.29	0.008	28.57	0.823	178.46
1.6 GHz	0.956	173.81	1.29	50.98	0.008	30.44	0.825	178.15
1.7 GHz	0.956	173.18	1.22	48.72	0.008	32.25	0.828	177.82
1.8 GHz	0.955	172.55	1.15	46.50	0.009	33.98	0.831	177.47
1.9 GHz	0.955	171.91	1.09	44.32	0.009	35.62	0.833	177.10
2.0 GHz	0.955	171.27	1.04	42.17	0.009	37.17	0.835	176.71
2.1 GHz	0.954	170.62	0.99	40.06	0.010	38.61	0.838	176.30
2.2 GHz	0.954	169.96	0.95	37.98	0.010	39.93	0.840	175.87
2.3 GHz	0.953	169.29	0.91	35.93	0.011	41.14	0.842	175.42
2.4 GHz	0.952	168.60	0.87	33.91	0.011	42.22	0.844	174.95
2.5 GHz	0.952	167.90	0.84	31.92	0.012	43.18	0.845	174.47
2.6 GHz	0.951	167.18	0.82	29.95	0.013	44.01	0.847	173.96
2.7 GHz	0.950	166.45	0.79	28.00	0.013	44.73	0.848	173.44
2.8 GHz	0.949	165.69	0.77	26.07	0.014	45.32	0.849	172.89
2.9 GHz	0.948	164.91	0.75	24.15	0.015	45.79	0.850	172.33
3.0 GHz	0.946	164.10	0.73	22.24	0.016	46.15	0.850	171.74
3.2 GHz	0.943	162.39	0.71	18.45	0.018	46.53	0.851	170.51
3.4 GHz	0.939	160.55	0.69	14.64	0.020	46.47	0.850	169.19
3.6 GHz	0.935	158.53	0.67	10.80	0.023	45.97	0.848	167.76
3.8 GHz	0.929	156.31	0.67	6.86	0.027	45.03	0.845	166.21
4.0 GHz	0.922	153.83	0.67	2.78	0.031	43.63	0.841	164.53
4.2 GHz	0.913	151.03	0.68	-1.51	0.036	41.72	0.834	162.69
4.4 GHz	0.901	147.82	0.69	-6.12	0.042	39.23	0.825	160.65
4.6 GHz	0.886	144.10	0.72	-11.16	0.049	36.07	0.813	158.39
4.8 GHz	0.866	139.68	0.76	-16.81	0.059	32.05	0.797	155.86
5.0 GHz	0.838	134.36	0.81	-23.30	0.073	26.92	0.775	153.00
5.2 GHz	0.799	127.78	0.88	-30.99	0.091	20.30	0.747	149.76
5.4 GHz	0.742	119.49	0.97	-40.41	0.117	11.55	0.708	146.16
5.6 GHz	0.658	108.92	1.08	-52.33	0.157	-0.34	0.657	142.31
5.8 GHz	0.534	95.85	1.21	-67.76	0.219	-16.90	0.594	138.62
6.0 GHz	0.373	82.93	1.34	-87.69	0.321	-40.38	0.534	134.70

Download this s-parameter file in ".s2p" format at http://www.cree.com/products/wireless_s-parameters.asp

Product Dimensions CGH40180PP (Package Type – 440199)

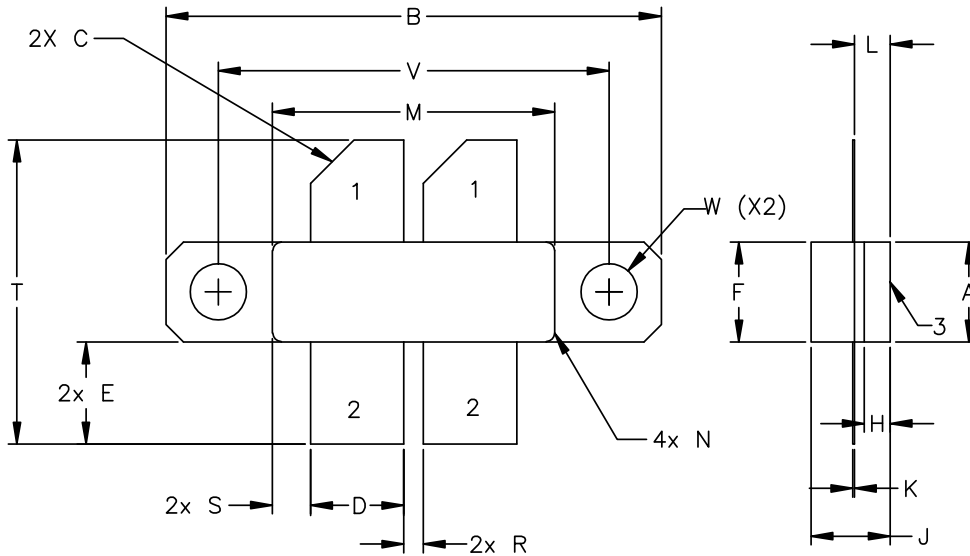

NOTES:

1. DIMENSIONING AND TOLERANCING PER ANSI Y14.5M, 1982.
2. CONTROLLING DIMENSION: INCH.
3. ADHESIVE FROM LID MAY EXTEND A MAXIMUM OF 0.020" BEYOND EDGE OF LID.
4. LID MAY BE MISALIGNED TO THE BODY OF PACKAGE BY A MAXIMUM OF 0.008" IN ANY DIRECTION.

DIM	INCHES		MILLIMETERS	
	MIN	MAX	MIN	MAX
A	0.225	0.235	5.72	5.97
B	1.135	1.145	28.83	29.00
C	0.10	45° REF	2.54	45° REF
D	0.210	0.220	5.33	5.59
E	0.230	0.240	5.84	6.00
F	0.225	0.235	5.71	5.97
H	0.055	0.065	1.40	1.65
J	0.151	0.171	3.84	4.34
K	0.003	0.006	0.08	0.15
L	0.075	0.085	1.91	2.16
M	0.643	0.657	16.30	16.70
N	R.020 REF		R0.51 REF	
R	0.040	0.050	1.00	1.27
S	0.083	0.093	2.10	2.36
T	0.680	0.720	17.30	18.30
V	0.895	0.905	22.70	22.98
W	Ø.130		Ø 3.30	

STYLE 1:
 PIN 1. GATE
 2. DRAIN
 3. SOURCE



Disclaimer

Specifications are subject to change without notice. Cree, Inc. believes the information contained within this data sheet to be accurate and reliable. However, no responsibility is assumed by Cree for any infringement of patents or other rights of third parties which may result from its use. No license is granted by implication or otherwise under any patent or patent rights of Cree. Cree makes no warranty, representation or guarantee regarding the suitability of its products for any particular purpose. "Typical" parameters are the average values expected by Cree in large quantities and are provided for information purposes only. These values can and do vary in different applications and actual performance can vary over time. All operating parameters should be validated by customer's technical experts for each application. Cree products are not designed, intended or authorized for use as components in applications intended for surgical implant into the body or to support or sustain life, in applications in which the failure of the Cree product could result in personal injury or death or in applications for planning, construction, maintenance or direct operation of a nuclear facility.

For more information, please contact:

Cree, Inc.
4600 Silicon Drive
Durham, North Carolina, USA 27703
www.cree.com/wireless

Sarah Miller
Marketing & Export
Cree, RF Components
1.919.407.5302

Ryan Baker
Marketing
Cree, RF Components
1.919.407.7816

Tom Dekker
Sales Director
Cree, RF Components
1.919.407.5639



Компания «ЭлектроПласт» предлагает заключение долгосрочных отношений при поставках импортных электронных компонентов на взаимовыгодных условиях!

Наши преимущества:

- Оперативные поставки широкого спектра электронных компонентов отечественного и импортного производства напрямую от производителей и с крупнейших мировых складов;
- Поставка более 17-ти миллионов наименований электронных компонентов;
- Поставка сложных, дефицитных, либо снятых с производства позиций;
- Оперативные сроки поставки под заказ (от 5 рабочих дней);
- Экспресс доставка в любую точку России;
- Техническая поддержка проекта, помощь в подборе аналогов, поставка прототипов;
- Система менеджмента качества сертифицирована по Международному стандарту ISO 9001;
- Лицензия ФСБ на осуществление работ с использованием сведений, составляющих государственную тайну;
- Поставка специализированных компонентов (Xilinx, Altera, Analog Devices, Intersil, Interpoint, Microsemi, Aeroflex, Peregrine, Syfer, Eurofarad, Texas Instrument, Miteq, Cobham, E2V, MA-COM, Hittite, Mini-Circuits, General Dynamics и др.);

Помимо этого, одним из направлений компании «ЭлектроПласт» является направление «Источники питания». Мы предлагаем Вам помощь Конструкторского отдела:

- Подбор оптимального решения, техническое обоснование при выборе компонента;
- Подбор аналогов;
- Консультации по применению компонента;
- Поставка образцов и прототипов;
- Техническая поддержка проекта;
- Защита от снятия компонента с производства.



Как с нами связаться

Телефон: 8 (812) 309 58 32 (многоканальный)

Факс: 8 (812) 320-02-42

Электронная почта: org@eplast1.ru

Адрес: 198099, г. Санкт-Петербург, ул. Калинина, дом 2, корпус 4, литера А.