

## TV-10/TV-15 rated 1a 30A, 2a 20A power relays

# HE RELAYS



1 Form A Plug-in type

RoHS compliant

### FEATURES

#### 1. Excellent resistance to contact welding

Owing to the pre-tension and kick-off mechanism, the 1 Form A passes TV-15 and the 2 Form A passes TV-10.

#### 2. High-capacity and long life

|                                     |   |               |
|-------------------------------------|---|---------------|
| Contact arrangement                 | 1 Form A type   | 2 Form A type |
| Contact capacity                    | 30A   | 20A           |
| Electrical life (at 20 times/min.)  | 2×10 <sup>5</sup>                                     |               |
| Mechanical life (at 180 times/min.) | DC type: 10 <sup>7</sup> , AC type: 5×10 <sup>6</sup> |               |

#### 3. Excellent surge resistance

Between contacts and coil, the surge voltage is more than 10,000 V (when surge waveform accords with JEC-212-1981).

#### 4. Compatible with all major safety standards

UL, CSA, VDE and TÜV certified

#### 5. Terminals are available

### TYPICAL APPLICATIONS

#### 1. Office equipment

Copiers, package air conditioners, automatic vending machines.

#### 2. Industrial equipment

Machine tools, molding equipment, wrapping machines, food processing equipment, etc.

#### 3. Home appliances

Air conditioners, microwave ovens, televisions, stereo systems, water heaters and air heating equipment.

|                            |                                     |                               |
|----------------------------|-------------------------------------|-------------------------------|
| Type                       | Single side stable type             |                               |
|                            | HE 1 Form A, 2 Form A               |                               |
| Insulation gap             | Min. 8 mm                           |                               |
| Distance between contacts* | 1 Form A and 2 Form A:<br>Min. 3 mm | PC board type:<br>Min. 2.5 mm |
| Breakdown voltage          | Between open contacts               | 2, 000 Vrms for 1 min.        |
|                            | Between contact and coil            | 5, 000 Vrms for 1 min.        |

\* Reference value

### CLASSIFICATION

| Type                | PC board           | Plug-in  |          | TM       |          | Screw terminal |          |
|---------------------|--------------------|----------|----------|----------|----------|----------------|----------|
| Operating function  | Single side stable |          |          |          |          |                |          |
| Contact arrangement | 1 Form A           | 1 Form A | 2 Form A | 1 Form A | 2 Form A | 1 Form A       | 2 Form A |

### ORDERING INFORMATION

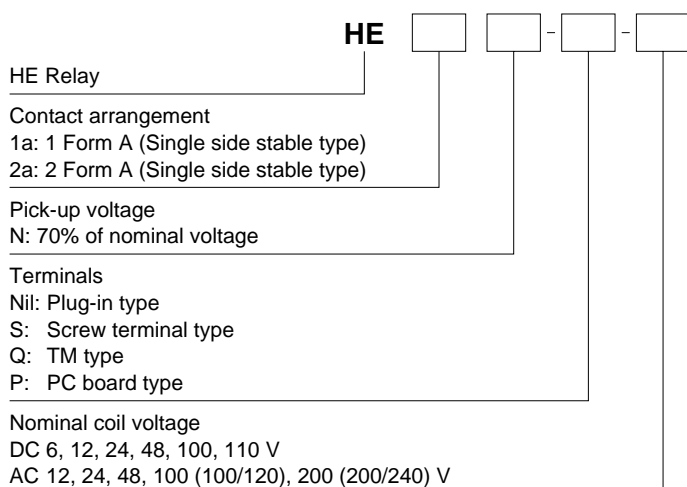

# HE

## TYPES

### 1. PC board type (1 Form A, DC coil) (Single side stable)

| Nominal coil voltage | 1 Form A       |  |
|----------------------|----------------|--|
|                      | Part No.       |  |
| 6V DC                | HE1aN-P-DC6V   |  |
| 12V DC               | HE1aN-P-DC12V  |  |
| 24V DC               | HE1aN-P-DC24V  |  |
| 48V DC               | HE1aN-P-DC48V  |  |
| 100V DC              | HE1aN-P-DC100V |  |
| 110V DC              | HE1aN-P-DC110V |  |

Standard packing: Carton: 25 pcs.; Case: 100 pcs.

### 2. Plug-in type (Single side stable)

| Type    | Nominal coil voltage | 1 Form A     |  | 2 Form A     |  |
|---------|----------------------|--------------|--|--------------|--|
|         |                      | Part No.     |  | Part No.     |  |
| DC type | 6V DC                | HE1aN-DC6V   |  | HE2aN-DC6V   |  |
|         | 12V DC               | HE1aN-DC12V  |  | HE2aN-DC12V  |  |
|         | 24V DC               | HE1aN-DC24V  |  | HE2aN-DC24V  |  |
|         | 48V DC               | HE1aN-DC48V  |  | HE2aN-DC48V  |  |
|         | 100V DC              | HE1aN-DC100V |  | HE2aN-DC100V |  |
|         | 110V DC              | HE1aN-DC110V |  | HE2aN-DC110V |  |
| AC type | 12V AC               | HE1aN-AC12V  |  | HE2aN-AC12V  |  |
|         | 24V AC               | HE1aN-AC24V  |  | HE2aN-AC24V  |  |
|         | 48V AC               | HE1aN-AC48V  |  | HE2aN-AC48V  |  |
|         | 100/120V AC          | HE1aN-AC100V |  | HE2aN-AC100V |  |
|         | 200/240V AC          | HE1aN-AC200V |  | HE2aN-AC200V |  |

Standard packing: Carton: 20 pcs.; Case: 100 pcs.

### 3. TM type (Single side stable)

| Type    | Nominal coil voltage | 1 Form A       |  | 2 Form A       |  |
|---------|----------------------|----------------|--|----------------|--|
|         |                      | Part No.       |  | Part No.       |  |
| DC type | 6V DC                | HE1aN-Q-DC6V   |  | HE2aN-Q-DC6V   |  |
|         | 12V DC               | HE1aN-Q-DC12V  |  | HE2aN-Q-DC12V  |  |
|         | 24V DC               | HE1aN-Q-DC24V  |  | HE2aN-Q-DC24V  |  |
|         | 48V DC               | HE1aN-Q-DC48V  |  | HE2aN-Q-DC48V  |  |
|         | 100V DC              | HE1aN-Q-DC100V |  | HE2aN-Q-DC100V |  |
|         | 110V DC              | HE1aN-Q-DC110V |  | HE2aN-Q-DC110V |  |
| AC type | 12V AC               | HE1aN-Q-AC12V  |  | HE2aN-Q-AC12V  |  |
|         | 24V AC               | HE1aN-Q-AC24V  |  | HE2aN-Q-AC24V  |  |
|         | 48V AC               | HE1aN-Q-AC48V  |  | HE2aN-Q-AC48V  |  |
|         | 100/120V AC          | HE1aN-Q-AC100V |  | HE2aN-Q-AC100V |  |
|         | 200/240V AC          | HE1aN-Q-AC200V |  | HE2aN-Q-AC200V |  |

Standard packing: Carton: 20 pcs.; Case: 100 pcs.

### 4. Screw terminal type (Single side stable)

| Type    | Nominal coil voltage | 1 Form A       |  | 2 Form A       |  |
|---------|----------------------|----------------|--|----------------|--|
|         |                      | Part No.       |  | Part No.       |  |
| DC type | 6V DC                | HE1aN-S-DC6V   |  | HE2aN-S-DC6V   |  |
|         | 12V DC               | HE1aN-S-DC12V  |  | HE2aN-S-DC12V  |  |
|         | 24V DC               | HE1aN-S-DC24V  |  | HE2aN-S-DC24V  |  |
|         | 48V DC               | HE1aN-S-DC48V  |  | HE2aN-S-DC48V  |  |
|         | 100V DC              | HE1aN-S-DC100V |  | HE2aN-S-DC100V |  |
|         | 110V DC              | HE1aN-S-DC110V |  | HE2aN-S-DC110V |  |
| AC type | 12V AC               | HE1aN-S-AC12V  |  | HE2aN-S-AC12V  |  |
|         | 24V AC               | HE1aN-S-AC24V  |  | HE2aN-S-AC24V  |  |
|         | 48V AC               | HE1aN-S-AC48V  |  | HE2aN-S-AC48V  |  |
|         | 100/120V AC          | HE1aN-S-AC100V |  | HE2aN-S-AC100V |  |
|         | 200/240V AC          | HE1aN-S-AC200V |  | HE2aN-S-AC200V |  |

Standard packing: Carton: 10 pcs.; Case: 50 pcs.

Note: The TM type of the screw terminals are also available.

\* For terminal sockets, see page 198.

## RATING

### 1. Coil data

#### 1) AC coils

| Nominal coil voltage | Pick-up voltage<br>(at 20°C 68°F)               | Drop-out voltage<br>(at 20°C 68°F)              | Nominal operating current<br>[±10%] (at 20°C 68°F) | Nominal operating power | Max. applied voltage<br>(at 20°C 68°F) |
|----------------------|---|---|--|-------------------------|--|
| 12V AC               | 70%V or less of<br>nominal voltage<br>(Initial) | 15%V or more of<br>nominal voltage<br>(Initial) | 138mA  | 1.7VA                   | 110%V of<br>nominal voltage            |
| 24V AC               |   |   | 74mA   | 1.8VA                   |  |
| 48V AC               |   |   | 39mA   | 1.9VA                   |  |
| 100/120V AC          |   |   | 18.7 to 2.1mA                                      | 1.9 to 2.7VA            |  |
| 200/240V AC          |   |   | 9.1 to 10.8mA                                      | 1.8 to 2.6VA            |  |

#### 2) DC coils

| Nominal coil voltage | Pick-up voltage<br>(at 20°C 68°F)               | Drop-out voltage<br>(at 20°C 68°F)              | Nominal operating<br>current<br>[±10%] (at 20°C 68°F) | Coil resistance<br>[±10%] (at 20°C 68°F) | Nominal operating<br>power | Max. applied voltage<br>(at 55°C 131°F) |
|----------------------|---|---|---|--|----------------------------|---|
| 6V DC                | 70%V or less of<br>nominal voltage<br>(Initial) | 10%V or more of<br>nominal voltage<br>(Initial) | 320mA   | 18.8Ω                                    | 1.92W                      | 110%V of<br>nominal voltage             |
| 12V DC               |   |   | 160mA   | 75Ω                                      | 1.92W                      |   |
| 24V DC               |   |   | 80mA  | 300Ω                                     | 1.92W                      |   |
| 48V DC               |   |   | 40mA  | 1,200Ω                                   | 1.92W                      |   |
| 100V DC              |   |   | 19mA  | 5,200Ω                                   | 1.92W                      |   |
| 110V DC              |   |   | 18mA  | 6,300Ω                                   | 1.92W                      |   |

### 2. Specifications

| Characteristics            | Item  | Specifications   |   |
|----------------------------|---|--|---|
| Contact                    | Contact material  | AgSnO <sub>2</sub> type  |   |
|                            | Arrangement   | 1 Form A   2 Form A  |   |
|                            | Contact resistance (Initial)                                      | Max. 100 mΩ (By voltage drop 6 V DC 1A)  |   |
| Rating                     | Nominal switching capacity (resistive load)                       | 30A 277V AC   25A 277V AC  |   |
|                            | Max. switching power  | 8,310VA   6,925VA  |   |
|                            | Max. switching voltage  | 277V AC, 30V DC  |   |
|                            | Max. switching current  | 30A   25A  |   |
|                            | Nominal operating power   | DC: 1.92W, AC: 1.7 to 2.7VA  |   |
|                            | Min. switching capacity (Reference value)*1                       | 100mA 5V DC  |   |
| Electrical characteristics | Insulation resistance (Initial)                                   | Min. 1,000MΩ (at 500V DC) Measurement at same location as "Breakdown voltage" section.   |   |
|                            | Breakdown voltage<br>(Initial)                                    | Between open contacts  | 2,000 Vrms for 1min (Detection current: 10mA.)  |
|                            |   | Between contact sets   | —   4,000 Vrms for 1min (Detection current: 10mA.)                                    |
|                            |   | Between contact and coil   | 5,000 Vrms for 1min (Detection current: 10mA.)  |
|                            | Temperature rise (coil)   | DC: Max. 60°C (at 55°C) (By resistive method), AC: Max. 65°C (at 55°C) (By resistive method)   |   |
|                            | Surge breakdown voltage*2<br>(between contact and coil) (Initial) | Min. 10,000V   |   |
| Mechanical characteristics | Shock resistance  | Functional   | Min. 98 m/s <sup>2</sup> (Half-wave pulse of sine wave: 11 ms; detection time: 10μs.) |
|                            |   | Destructive  | Min. 980 m/s <sup>2</sup> (Half-wave pulse of sine wave: 6 ms.)                       |
|                            | Vibration resistance  | Functional   | 10 to 55 Hz at double amplitude of 1 mm (Detection time: 10μs.)                       |
|                            |   | Destructive  | 10 to 55 Hz at double amplitude of 1.5 mm   |
| Expected life              | Mechanical  | DC: Min. 10 <sup>7</sup> (at 180 times/min.), AC: Min. 5×10 <sup>6</sup> (at 180 times/min.)   |   |
|                            | Electrical (resistive load) (at 20 times/min.)                    | Min. 10 <sup>5</sup> (30A 277V AC)   Min. 10 <sup>5</sup> (25A 277V AC)<br>Min. 2×10 <sup>5</sup> (30A 250V AC)   Min. 2×10 <sup>5</sup> (20A 250V AC)         |   |
| Conditions                 | Conditions for operation, transport and storage*3                 | Ambient temperature: -50°C to +55°C -58°F to +131°F<br>Humidity: 5 to 85% R.H. (Not freezing and condensing at low temperature),<br>Air pressure: 86 to 106kPa |   |
|                            | Max. operating speed  | 20 times/min. (at max. rating)   |   |
| Unit weight                |   | PC board type: approx. 80g 2.82oz, Plug-in type/TM type: approx. 90g 3.17oz,<br>Screw terminal type: approx. 120g 4.23oz                                       |   |

Notes: \*1. This value can change due to the switching frequency, environmental conditions, and desired reliability level, therefore it is recommended to check this with the actual load.

\*2. Wave is standard shock voltage of ±1.2×50μs according to JEC-212-1981

\*3. The upper limit of the ambient temperature is the maximum temperature that can satisfy the coil temperature rise value. Refer to Usage, transport and storage conditions in NOTES.

## REFERENCE DATA

### 1 Form A Type

#### 1. Maximum switching power



#### 2. Life curve

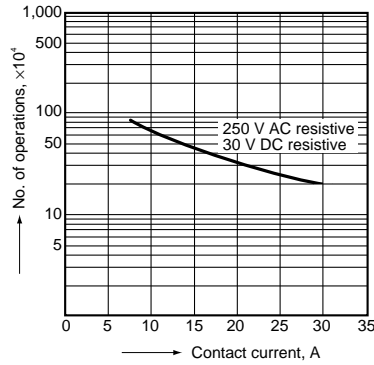

#### 3. Coil temperature rise (DC type)

Measured portion: Inside the coil  
Contact current: 30 A

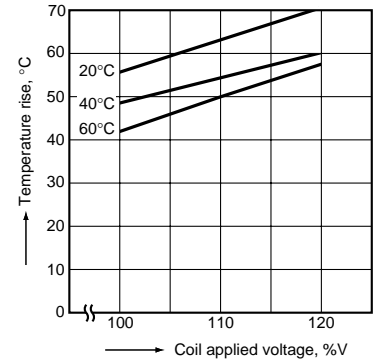

#### 4. Ambient temperature characteristics

Tested sample: HE1aN-AC120V, 6 pcs.



### 2 Form A Type

#### 1. Maximum switching power



#### 2. Life curve

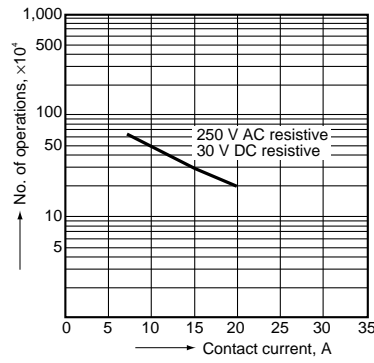

#### 3. Coil temperature rise (DC type)

Measured portion: Inside the coil  
Contact current: 30 A

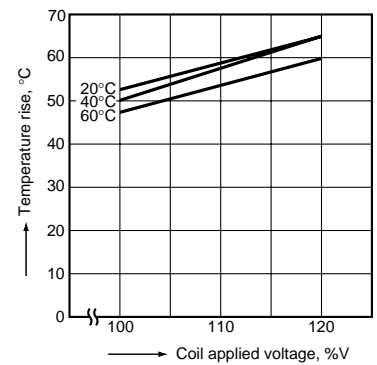

#### 4. Ambient temperature characteristics

Tested sample: HE2aN-AC120V, 6 pcs.



**DIMENSIONS** (mm inch)

The CAD data of the products with a **CAD Data** mark can be downloaded from: <http://industrial.panasonic.com/ac/e/>

**1. PC board type**

1 Form A

**CAD Data**

External dimensions  
Single side stable type

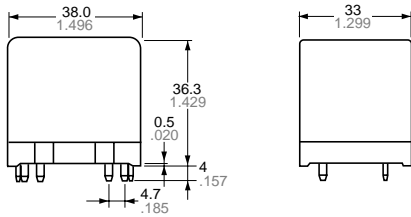

General tolerance:  $\pm 0.3 \pm 0.012$

Schematic (Bottom view)  
Single side stable type

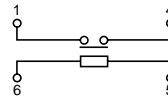

PC board pattern (Bottom view)

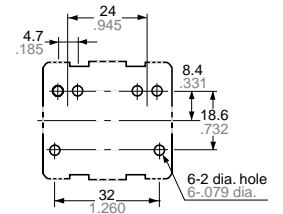

Tolerance:  $\pm 0.1 \pm 0.004$

**2. Plug-in type**

1 Form A

**CAD Data**

External dimensions  
Single side stable type

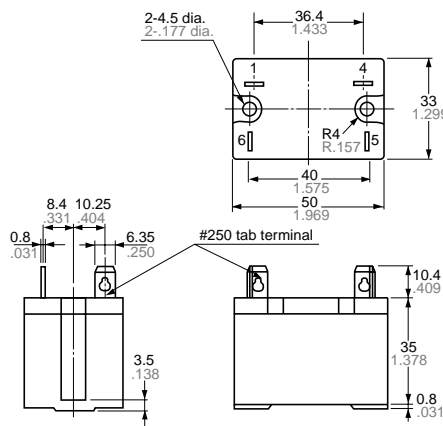

General tolerance:  $\pm 0.3 \pm 0.012$

Schematic (Bottom view)  
Single side stable type

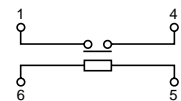

Panel cutout

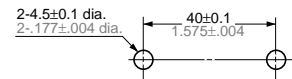

Tolerance:  $\pm 0.1 \pm 0.004$

2 Form A

**CAD Data**

External dimensions  
Single side stable type

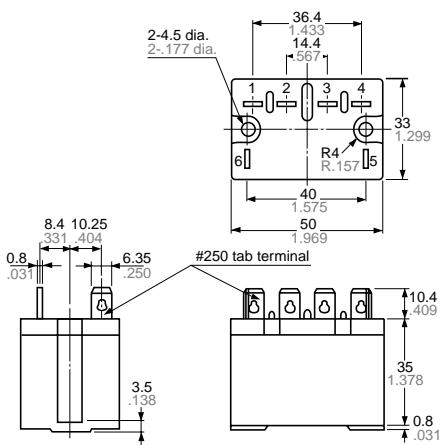

General tolerance:  $\pm 0.3 \pm 0.012$

Schematic (Bottom view)  
Single side stable type

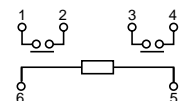

Panel cutout

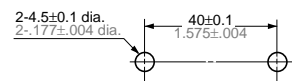

Tolerance:  $\pm 0.1 \pm 0.004$

## 3. TM type

**CAD Data**

External dimensions  
Single side stable type

1 Form A

2 Form A

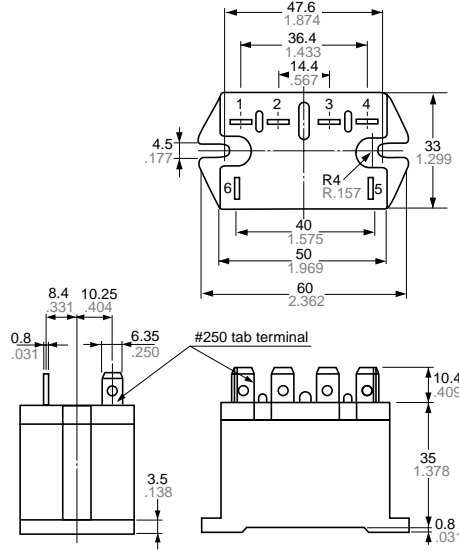
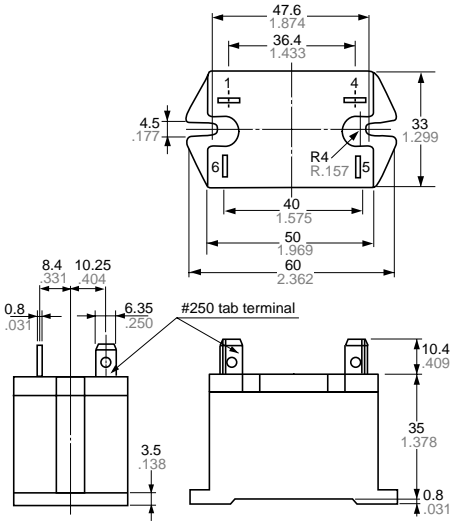

Schematic (Bottom view)  
Single side stable type

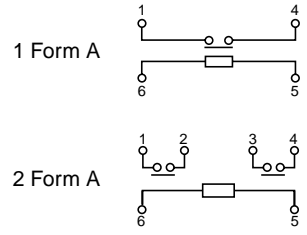

Panel cutout

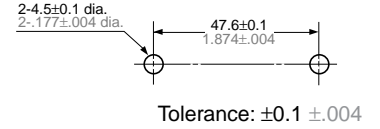

General tolerance:  $\pm 0.3 \pm .012$

## 4. Screw terminal type

1 Form A

**CAD Data**

External dimensions  
Single side stable type

Schematic (Bottom view)  
Single side stable type

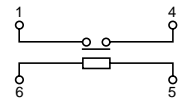
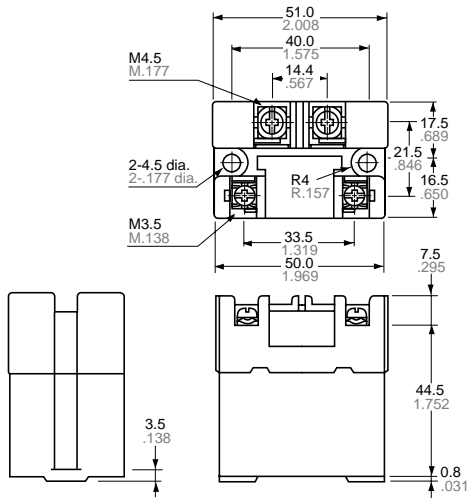

Panel cutout

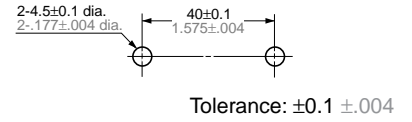

General tolerance:  $\pm 0.3 \pm .012$

2 Form A

**CAD Data**

**External dimensions**  
Single side stable type

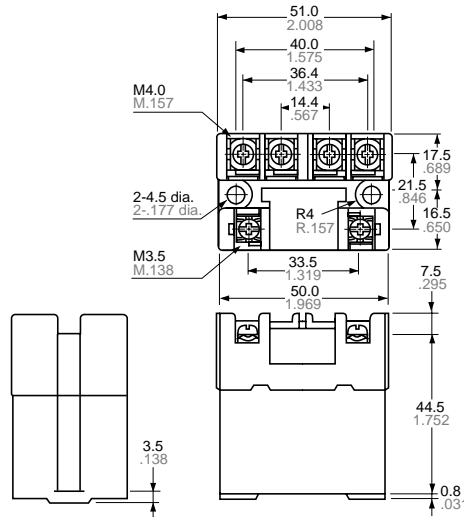

General tolerance:  $\pm 0.3 \pm 0.12$

**Schematic (Bottom view)**  
Single side stable type

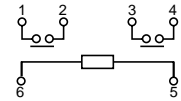

**Panel cutout**

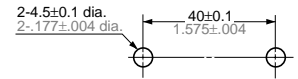

Tolerance:  $\pm 0.1 \pm 0.04$

**MOUNTING METHOD**

**1. Plug-in type**

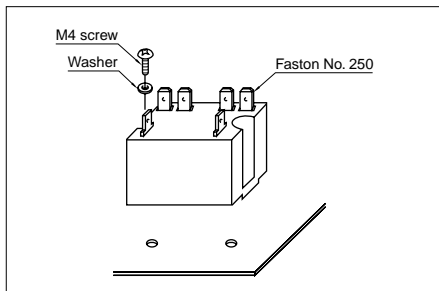

**2. Screw terminal type**

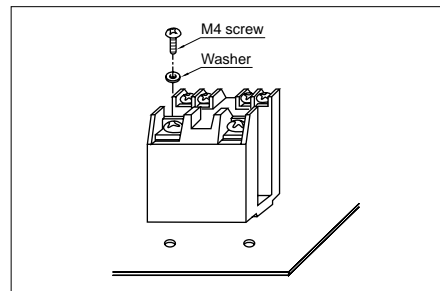

**3. Allowable installation wiring size for screw terminal types and terminal sockets**

Due to the UP terminals, it is possible to either directly connect the wires or use crimped terminal.

**SAFETY STANDARDS**

| Item     | UL/C-UL (Recognized) |   | CSA (Certified) |   | VDE (Certified) |  | TV rating (UL/CSA) |        | TÜV (Certified)      |  |
|----------|----------------------|---|-----------------|---|-----------------|--|--------------------|--------|----------------------|--|
|          | File No.             | Contact rating  | File No.        | Contact rating  | File No.        | Contact rating   | File No.           | Rating | File No.             | Rating   |
| 1 Form A | E43028               | 30A 277V AC<br>30A 30V DC<br>1.5HP 125V AC<br>3HP 250V AC | LR26550<br>etc. | 30A 277V AC<br>30A 30V DC<br>1.5HP 125V AC<br>3HP 250V AC | 40006681        | 30A 250V AC (cosφ=1.0)<br>30A 250V AC (cosφ=0.4)<br>5A 110V DC (0ms) | UL<br>E43028       | TV-15  | B 11 04<br>13461 293 | 30A 250V AC (cosφ=1.0)<br>30A 250V AC (cosφ=0.4)<br>8A 110V DC (0ms) |
| 2 Form A | E43028               | 25A 277V AC<br>25A 30V DC<br>1HP 125V AC<br>2HP 250V AC   | LR26550<br>etc. | 25A 277V AC<br>25A 30V DC<br>1HP 125V AC<br>2HP 250V AC   | 40006681        | 25A 250V AC (cosφ=1.0)<br>25A 250V AC (cosφ=0.4)<br>5A 110V DC (0ms) | UL<br>E43028       | TV-10  | B 11 04<br>13461 293 | 25A 250V AC (cosφ=1.0)<br>25A 250V AC (cosφ=0.4)<br>8A 110V DC (0ms) |

**NOTES**

- The dust cover should not be removed since doing so may alter the characteristics.
- Avoid use under severe environmental conditions, such as high humidity, organic gas or in dust, oily locations and locations subjected to extremely frequent shock or vibrations.
- When mounting, use spring washers. Optimum fastening torque ranges from 49 to 68.6 N·m (5 to 7 kgf·cm).

- Firmly insert the receptacles so that there is no slack or looseness. To remove a receptacle, 19.6 to 39.2 N (2 to 4 kg) of pulling strength is required. Do not remove more than one receptacle at one time. Always remove one receptacle at a time and pull it straight outwards.
- When using the AC type, the operate time due to the in-rush phase is 20 ms or more. Therefore, it is necessary for you to verify the characteristics for your actual circuit.

- When using the push-on blocks for the screw terminal type, use crimped terminals and tighten the screw-down terminals to the torque below.  
M4.5 screw:  
147 to 166.6 N·cm (15 to 17 kgf·cm)  
M4 screw:  
117.6 to 137 N·cm (12 to 14 kgf·cm)  
M3.5 screw:  
78.4 to 98 N·cm (8 to 10 kgf·cm)

**For Cautions for Use.**

# Mouser Electronics

Authorized Distributor

Click to View Pricing, Inventory, Delivery & Lifecycle Information:

## Panasonic:

[HE2AN-Q-DC12V](#) [HE2AN-Q-DC24V](#) [HE1AN-AC120V](#) [HE1AN-Q-AC120V](#) [HE1AN-AC240V](#) [HE1AN-Q-AC240V](#)  
[HE2AN-DC12V](#) [HE2AN-Q-AC120V](#) [HE1AN-Q-DC24V](#) [HE1AN-S-AC120V](#) [HE1AN-S-DC12V](#) [HE1AN-AC24V](#)  
[HE2AN-Q-AC24V](#) [HE1AN-Q-DC12V](#) [HE1AN-Q-DC48V](#) [HE2AN-DC24V](#) [HE1AN-DC12V](#) [HE1AN-S-DC24V](#) [HE1AN-](#)  
[DC24V](#) [HE2AN-S-DC24V](#) [HE2AN-SW-DC24V](#) [HE2AN-Q-AC240V](#) [HE1AN-DC6V](#) [HE1AN-AC12V](#) [HE1AN-AC48V](#)  
[HE1AN-DC110V](#) [HE1AN-DC48V](#) [HE1AN-P-DC12V](#) [HE1AN-P-DC24V](#) [HE1AN-P-DC48V](#) [HE1AN-Q-AC12V](#) [HE1AN-](#)  
[Q-AC24V](#) [HE1AN-Q-AC48V](#) [HE1AN-Q-DC110V](#) [HE1AN-Q-DC6V](#) [HE1AN-S-AC12V](#) [HE1AN-S-AC240V](#) [HE1AN-S-](#)  
[AC24V](#) [HE1AN-S-AC48V](#) [HE1AN-S-DC110V](#) [HE1AN-S-DC48V](#) [HE1AN-S-DC6V](#) [HE1AN-SW-AC120V](#) [HE1AN-SW-](#)  
[AC12V](#) [HE1AN-SW-AC240V](#) [HE1AN-SW-AC24V](#) [HE1AN-SW-DC110V](#) [HE1AN-SW-DC12V](#) [HE1AN-SW-DC24V](#)  
[HE1AN-SW-DC6V](#) [HE2AN-AC120V](#) [HE2AN-AC12V](#) [HE2AN-AC240V](#) [HE2AN-AC24V](#) [HE2AN-AC48V](#) [HE2AN-](#)  
[DC110V](#) [HE2AN-DC48V](#) [HE2AN-DC6V](#) [HE2AN-Q-AC12V](#) [HE2AN-Q-AC48V](#) [HE2AN-Q-DC110V](#) [HE2AN-Q-DC48V](#)  
[HE2AN-Q-DC6V](#) [HE2AN-S-AC120V](#) [HE2AN-S-AC12V](#) [HE2AN-S-AC240V](#) [HE2AN-S-AC24V](#) [HE2AN-S-AC48V](#)  
[HE2AN-S-DC110V](#) [HE2AN-S-DC12V](#) [HE2AN-S-DC48V](#) [HE2AN-S-DC6V](#) [HE2AN-SW-AC120V](#) [HE2AN-SW-AC240V](#)  
[HE2AN-SW-AC24V](#) [HE2AN-SW-DC110V](#) [HE2AN-SW-DC12V](#) [HE2AN-SW-DC48V](#) [HE2AN-SW-DC6V](#) [HE2AN-P-](#)  
[DC24V](#)





Компания «ЭлектроПласт» предлагает заключение долгосрочных отношений при поставках импортных электронных компонентов на взаимовыгодных условиях!

Наши преимущества:

- Оперативные поставки широкого спектра электронных компонентов отечественного и импортного производства напрямую от производителей и с крупнейших мировых складов;
- Поставка более 17-ти миллионов наименований электронных компонентов;
- Поставка сложных, дефицитных, либо снятых с производства позиций;
- Оперативные сроки поставки под заказ (от 5 рабочих дней);
- Экспресс доставка в любую точку России;
- Техническая поддержка проекта, помощь в подборе аналогов, поставка прототипов;
- Система менеджмента качества сертифицирована по Международному стандарту ISO 9001;
- Лицензия ФСБ на осуществление работ с использованием сведений, составляющих государственную тайну;
- Поставка специализированных компонентов (Xilinx, Altera, Analog Devices, Intersil, Interpoint, Microsemi, Aeroflex, Peregrine, Syfer, Eurofarad, Texas Instrument, Miteq, Cobham, E2V, MA-COM, Hittite, Mini-Circuits, General Dynamics и др.);

Помимо этого, одним из направлений компании «ЭлектроПласт» является направление «Источники питания». Мы предлагаем Вам помощь Конструкторского отдела:

- Подбор оптимального решения, техническое обоснование при выборе компонента;
- Подбор аналогов;
- Консультации по применению компонента;
- Поставка образцов и прототипов;
- Техническая поддержка проекта;
- Защита от снятия компонента с производства.



#### Как с нами связаться

**Телефон:** 8 (812) 309 58 32 (многоканальный)

**Факс:** 8 (812) 320-02-42

**Электронная почта:** [org@eplast1.ru](mailto:org@eplast1.ru)

**Адрес:** 198099, г. Санкт-Петербург, ул. Калинина, дом 2, корпус 4, литера А.