

### FEATURES

- Compact TSOT packages
- Low temperature coefficient
  - B grade: 9 ppm/°C
  - A grade: 25 ppm/°C
- Initial accuracy
  - B grade: ±3 mV maximum
  - A grade: ±6 mV maximum
- Ultralow output noise: 6.8 μV p-p (0.1 Hz to 10 Hz)
- Low dropout: 300 mV
- Low supply current: 190 μA maximum
- No external capacitor required
- Output current: +5 mA/−1 mA
- Wide temperature range: −40°C to +125°C
- Qualified for automotive applications

### APPLICATIONS

- Battery-powered instruments
- Portable medical instruments
- Data acquisition systems
- Industrial process controls
- Automotive

### GENERAL DESCRIPTION

The ADR360/ADR361/ADR363/ADR364/ADR365/ADR366 are precision 2.048 V, 2.5 V, 3.0 V, 4.096 V, 5.0 V, and 3.3 V band gap voltage references that offer low power and high precision in tiny footprints. Using patented temperature drift curvature correction techniques from Analog Devices, Inc., the ADR36x references achieve a low temperature drift of 9 ppm/°C in a TSOT package.

The ADR36x family of micropower, low dropout voltage references provides a stable output voltage from a minimum

### PIN CONFIGURATION

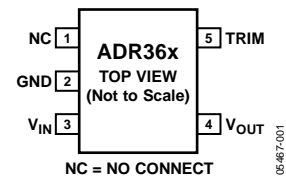

Figure 1. 5-Lead TSOT (UJ)

Table 1. ADR36x Family of Devices

Model	V <sub>OUT</sub> (V) <sup>1</sup>	Temperature Coefficient (ppm/°C)	Accuracy (mV)
ADR360B	2.048	9	±3
ADR360A	2.048	25	±6
ADR361B	2.5	9	±3
ADR361A	2.5	25	±6
ADR363B	3.0	9	±3
ADR363A	3.0	25	±6
ADR364B	4.096	9	±4
ADR364A	4.096	25	±8
ADR365B	5.0	9	±4
ADR365A	5.0	25	±8
ADR366B	3.3	9	±4
ADR366A	3.3	25	±8

<sup>1</sup> Contact Analog Devices for other voltage options.

supply of 300 mV above the output. Their advanced design eliminates the need for external capacitors, which further reduces board space and system cost. The combination of low power operation, small size, and ease of use makes the ADR36x precision voltage references ideally suited for battery-operated applications.

See the Ordering Guide for automotive grades.

#### Rev. D

Information furnished by Analog Devices is believed to be accurate and reliable. However, no responsibility is assumed by Analog Devices for its use, nor for any infringements of patents or other rights of third parties that may result from its use. Specifications subject to change without notice. No license is granted by implication or otherwise under any patent or patent rights of Analog Devices. Trademarks and registered trademarks are the property of their respective owners.

## TABLE OF CONTENTS

Features .....	1	Thermal Resistance .....	9
Applications.....	1	ESD Caution.....	9
Pin Configuration.....	1	Typical Performance Characteristics .....	10
General Description .....	1	Terminology .....	15
Revision History .....	2	Theory of Operation .....	16
Specifications.....	3	Device Power Dissipation Considerations.....	16
ADR360 Electrical Characteristics.....	3	Input Capacitor.....	16
ADR361 Electrical Characteristics.....	4	Output Capacitor.....	16
ADR363 Electrical Characteristics.....	5	Applications Information .....	17
ADR364 Electrical Characteristics.....	6	Basic Voltage Reference Connection .....	17
ADR365 Electrical Characteristics.....	7	Outline Dimensions .....	19
ADR366 Electrical Characteristics.....	8	Ordering Guide .....	20
Absolute Maximum Ratings.....	9	Automotive Products.....	20

## REVISION HISTORY

### 10/10—Rev. C to Rev. D

Changes to Features Section and General Description Section .	1
Changed Supply Voltage Headroom to Dropout Voltage Throughout .....	3
Changed 0.1 Hz to 10 Hz to $f = 0.1 \text{ Hz to } 10 \text{ Hz}$ Throughout...	3
Change to Table 8 .....	9
Changes to Figure 13.....	11
Changes to Figure 14.....	12
Changes to Ordering Guide .....	20
Added Automotive Products Section .....	20

### 7/07—Rev. B to Rev. C

Changes to Ripple Rejection Ratio in Table 2.....	3
Changes to Ripple Rejection Ratio in Table 3.....	4
Changes to Ripple Rejection Ratio in Table 4.....	5
Changes to Ripple Rejection Ratio in Table 5.....	6
Changes to Ripple Rejection Ratio in Table 6.....	7
Changes to Ripple Rejection Ratio in Table 7.....	8

### 2/07—Rev. A to Rev. B

Changes to Table 7.....	8
Changes to Figure 6.....	11
Changes to Figure 13, Figure 14, Figure 17, and Figure 27 Captions.....	12
Changes to Ordering Guide .....	19

### 3/06—Rev. 0 to Rev. A

Changes to Figure 15 Caption .....	13
Changes to Figure 21 Caption .....	14
Changes to Theory of Operation Section.....	16
Changes to Figure 36.....	18

### 4/05—Revision 0: Initial Version

## SPECIFICATIONS

### ADR360 ELECTRICAL CHARACTERISTICS

$V_{IN} = 2.35\text{ V to }15\text{ V}$ ,  $T_A = 25^\circ\text{C}$ , unless otherwise noted.

**Table 2.**

Parameter	Symbol	Conditions	Min	Typ	Max	Unit
OUTPUT VOLTAGE	$V_{OUT}$	A grade	2.042	2.048	2.054	V
		B grade	2.045	2.048	2.051	V
INITIAL ACCURACY	$V_{OUTERR}$	A grade			$\pm 6$	mV
		A grade			$\pm 0.29$	%
		B grade			$\pm 3$	mV
		B grade			$\pm 0.15$	%
TEMPERATURE COEFFICIENT	$TCV_{OUT}$	A grade, $-40^\circ\text{C} < T_A < +125^\circ\text{C}$			25	ppm/ $^\circ\text{C}$
		B grade, $-40^\circ\text{C} < T_A < +125^\circ\text{C}$			9	ppm/ $^\circ\text{C}$
DROPOUT VOLTAGE	$V_{IN} - V_{OUT}$		300			mV
LINE REGULATION	$\Delta V_{OUT}/\Delta V_{IN}$	$V_{IN} = 2.45\text{ V to }15\text{ V}$ , $-40^\circ\text{C} < T_A < +125^\circ\text{C}$			0.105	mV/V
LOAD REGULATION	$\Delta V_{OUT}/\Delta I_{LOAD}$	$I_{LOAD} = 0\text{ mA to }5\text{ mA}$ , $-40^\circ\text{C} < T_A < +125^\circ\text{C}$ , $V_{IN} = 3\text{ V}$			0.37	mV/mA
		$I_{LOAD} = -1\text{ mA to }0\text{ mA}$ , $-40^\circ\text{C} < T_A < +125^\circ\text{C}$ , $V_{IN} = 3\text{ V}$			0.82	mV/mA
QUIESCENT CURRENT	$I_{IN}$	$-40^\circ\text{C} < T_A < +125^\circ\text{C}$		150	190	$\mu\text{A}$
VOLTAGE NOISE	$e_{N\text{ p-p}}$	$f = 0.1\text{ Hz to }10\text{ Hz}$		6.8		$\mu\text{V p-p}$
TURN-ON SETTLING TIME	$t_R$			25		$\mu\text{s}$
LONG-TERM STABILITY <sup>1</sup>	$\Delta V_{OUT}$	1000 hours		50		ppm
OUTPUT VOLTAGE HYSTERESIS	$\Delta V_{OUT\_HYS}$			100		ppm
RIPPLE REJECTION RATIO	RRR	$f_{IN} = 60\text{ Hz}$		-70		dB
SHORT CIRCUIT TO GND	$I_{SC}$	$V_{IN} = 5\text{ V}$		25		mA
		$V_{IN} = 15\text{ V}$		30		mA

<sup>1</sup> The long-term stability specification is noncumulative. The drift after the first 1000 hours is significantly lower than it is in the first 1000 hours.

# ADR360/ADR361/ADR363/ADR364/ADR365/ADR366

## ADR361 ELECTRICAL CHARACTERISTICS

$V_{IN} = 2.8\text{ V to }15\text{ V}$ ,  $T_A = 25^\circ\text{C}$ , unless otherwise noted.

Table 3.

Parameter	Symbol	Conditions	Min	Typ	Max	Unit
OUTPUT VOLTAGE	$V_{OUT}$	A grade	2.494	2.500	2.506	V
		B grade	2.497	2.500	2.503	V
INITIAL ACCURACY	$V_{OUTERR}$	A grade			$\pm 6$	mV
		A grade			$\pm 0.24$	%
		B grade			$\pm 3$	mV
		B grade			$\pm 0.12$	%
TEMPERATURE COEFFICIENT	$TCV_{OUT}$	A grade, $-40^\circ\text{C} < T_A < +125^\circ\text{C}$			25	ppm/ $^\circ\text{C}$
		B grade, $-40^\circ\text{C} < T_A < +125^\circ\text{C}$			9	ppm/ $^\circ\text{C}$
DROPOUT VOLTAGE	$V_{IN} - V_{OUT}$		300			mV
LINE REGULATION	$\Delta V_{OUT}/\Delta V_{IN}$	$V_{IN} = 2.8\text{ V to }15\text{ V}$ , $-40^\circ\text{C} < T_A < +125^\circ\text{C}$			0.125	mV/V
LOAD REGULATION	$\Delta V_{OUT}/\Delta I_{LOAD}$	$I_{LOAD} = 0\text{ mA to }5\text{ mA}$ , $-40^\circ\text{C} < T_A < +125^\circ\text{C}$ , $V_{IN} = 3.5\text{ V}$			0.45	mV/mA
		$I_{LOAD} = -1\text{ mA to }0\text{ mA}$ , $-40^\circ\text{C} < T_A < +125^\circ\text{C}$ , $V_{IN} = 3.5\text{ V}$			1	mV/mA
QUIESCENT CURRENT	$I_{IN}$	$-40^\circ\text{C} < T_A < +125^\circ\text{C}$		150	190	$\mu\text{A}$
VOLTAGE NOISE	$e_{N\text{ p-p}}$	$f = 0.1\text{ Hz to }10\text{ Hz}$		8.25		$\mu\text{V p-p}$
TURN-ON SETTLING TIME	$t_R$			25		$\mu\text{s}$
LONG-TERM STABILITY <sup>1</sup>	$\Delta V_{OUT}$	1000 hours		50		ppm
OUTPUT VOLTAGE HYSTERESIS	$\Delta V_{OUT\_HYS}$			100		ppm
RIPPLE REJECTION RATIO	RRR	$f_{IN} = 60\text{ Hz}$		-70		dB
SHORT CIRCUIT TO GND	$I_{SC}$	$V_{IN} = 5\text{ V}$		25		mA
		$V_{IN} = 15\text{ V}$		30		mA

<sup>1</sup> The long-term stability specification is noncumulative. The drift after the first 1000 hours is significantly lower than it is in the first 1000 hours.

## ADR363 ELECTRICAL CHARACTERISTICS

$V_{IN} = 3.3\text{ V to }15\text{ V}$ ,  $T_A = 25^\circ\text{C}$ , unless otherwise noted.

**Table 4.**

Parameter	Symbol	Conditions	Min	Typ	Max	Unit
OUTPUT VOLTAGE	$V_{OUT}$	A grade	2.994	3.000	3.006	V
		B grade	2.997	3.000	3.003	V
INITIAL ACCURACY	$V_{OUTERR}$	A grade			$\pm 6$	mV
		A grade			$\pm 0.2$	%
		B grade			$\pm 3$	mV
		B grade			$\pm 0.1$	%
TEMPERATURE COEFFICIENT	$TCV_{OUT}$	A grade, $-40^\circ\text{C} < T_A < +125^\circ\text{C}$			25	ppm/ $^\circ\text{C}$
		B grade, $-40^\circ\text{C} < T_A < +125^\circ\text{C}$			9	ppm/ $^\circ\text{C}$
DROPOUT VOLTAGE	$V_{IN} - V_{OUT}$		300			mV
LINE REGULATION	$\Delta V_{OUT}/\Delta V_{IN}$	$V_{IN} = 3.3\text{ V to }15\text{ V}$ , $-40^\circ\text{C} < T_A < +125^\circ\text{C}$			0.15	mV/V
LOAD REGULATION	$\Delta V_{OUT}/\Delta I_{LOAD}$	$I_{LOAD} = 0\text{ mA to }5\text{ mA}$ , $-40^\circ\text{C} < T_A < +125^\circ\text{C}$ , $V_{IN} = 4\text{ V}$			0.54	mV/mA
		$I_{LOAD} = -1\text{ mA to }0\text{ mA}$ , $-40^\circ\text{C} < T_A < +125^\circ\text{C}$ , $V_{IN} = 4\text{ V}$			1.2	mV/mA
QUIESCENT CURRENT	$I_{IN}$	$-40^\circ\text{C} < T_A < +125^\circ\text{C}$		150	190	$\mu\text{A}$
VOLTAGE NOISE	$e_{N\text{ p-p}}$	$f = 0.1\text{ Hz to }10\text{ Hz}$		8.7		$\mu\text{V p-p}$
TURN-ON SETTLING TIME	$t_R$			25		$\mu\text{s}$
LONG-TERM STABILITY <sup>1</sup>	$\Delta V_{OUT}$	1000 hours		50		ppm
OUTPUT VOLTAGE HYSTERESIS	$\Delta V_{OUT\_HYS}$			100		ppm
RIPPLE REJECTION RATIO	RRR	$f_{IN} = 60\text{ Hz}$		-70		dB
SHORT CIRCUIT TO GND	$I_{SC}$	$V_{IN} = 5\text{ V}$		25		mA
		$V_{IN} = 15\text{ V}$		30		mA

<sup>1</sup> The long-term stability specification is noncumulative. The drift after the first 1000 hours is significantly lower than it is in the first 1000 hours.

# ADR360/ADR361/ADR363/ADR364/ADR365/ADR366

## ADR364 ELECTRICAL CHARACTERISTICS

$V_{IN} = 4.4 \text{ V}$  to  $15 \text{ V}$ ,  $T_A = 25^\circ\text{C}$ , unless otherwise noted.

Table 5.

Parameter	Symbol	Conditions	Min	Typ	Max	Unit
OUTPUT VOLTAGE	$V_{OUT}$	A grade	4.088	4.096	4.104	V
		B grade	4.092	4.096	4.100	V
INITIAL ACCURACY	$V_{OUTERR}$	A grade			$\pm 8$	mV
		A grade			$\pm 0.2$	%
		B grade			$\pm 4$	mV
		B grade			$\pm 0.1$	%
TEMPERATURE COEFFICIENT	$TCV_{OUT}$	A grade, $-40^\circ\text{C} < T_A < +125^\circ\text{C}$			25	ppm/ $^\circ\text{C}$
		B grade, $-40^\circ\text{C} < T_A < +125^\circ\text{C}$			9	ppm/ $^\circ\text{C}$
DROPOUT VOLTAGE	$V_{IN} - V_{OUT}$		300			mV
LINE REGULATION	$\Delta V_{OUT}/\Delta V_{IN}$	$V_{IN} = 4.4 \text{ V}$ to $15 \text{ V}$ , $-40^\circ\text{C} < T_A < +125^\circ\text{C}$			0.205	mV/V
LOAD REGULATION	$\Delta V_{OUT}/\Delta I_{LOAD}$	$I_{LOAD} = 0 \text{ mA}$ to $5 \text{ mA}$ , $-40^\circ\text{C} < T_A < +125^\circ\text{C}$ , $V_{IN} = 5 \text{ V}$			0.735	mV/mA
		$I_{LOAD} = -1 \text{ mA}$ to $0 \text{ mA}$ , $-40^\circ\text{C} < T_A < +125^\circ\text{C}$ , $V_{IN} = 5 \text{ V}$			1.75	mV/mA
QUIESCENT CURRENT	$I_{IN}$	$-40^\circ\text{C} < T_A < +125^\circ\text{C}$		150	190	$\mu\text{A}$
VOLTAGE NOISE	$e_{N \text{ p-p}}$	$f = 0.1 \text{ Hz}$ to $10 \text{ Hz}$		11		$\mu\text{V p-p}$
TURN-ON SETTLING TIME	$t_R$			25		$\mu\text{s}$
LONG-TERM STABILITY <sup>1</sup>	$\Delta V_{OUT}$	1000 hours		50		ppm
OUTPUT VOLTAGE HYSTERESIS	$\Delta V_{OUT\_HYS}$			100		ppm
RIPPLE REJECTION RATIO	RRR	$f_{IN} = 60 \text{ Hz}$		-70		dB
SHORT CIRCUIT TO GND	$I_{SC}$	$V_{IN} = 5 \text{ V}$		25		mA
		$V_{IN} = 15 \text{ V}$		30		mA

<sup>1</sup> The long-term stability specification is noncumulative. The drift after the first 1000 hours is significantly lower than it is in the first 1000 hours.

## ADR365 ELECTRICAL CHARACTERISTICS

$V_{IN} = 5.3\text{ V to }15\text{ V}$ ,  $T_A = 25^\circ\text{C}$ , unless otherwise noted.

**Table 6.**

Parameter	Symbol	Conditions	Min	Typ	Max	Unit
OUTPUT VOLTAGE	$V_{OUT}$	A grade	4.992	5.000	5.008	V
		B grade	4.996	5.000	5.004	V
INITIAL ACCURACY	$V_{OUTERR}$	A grade			$\pm 8$	mV
		A grade			$\pm 0.16$	%
		B grade			$\pm 4$	mV
		B grade			$\pm 0.08$	%
TEMPERATURE COEFFICIENT	$TCV_{OUT}$	A grade, $-40^\circ\text{C} < T_A < +125^\circ\text{C}$			25	ppm/ $^\circ\text{C}$
		B grade, $-40^\circ\text{C} < T_A < +125^\circ\text{C}$			9	ppm/ $^\circ\text{C}$
DROPOUT VOLTAGE	$V_{IN} - V_{OUT}$		300			mV
LINE REGULATION	$\Delta V_{OUT}/\Delta V_{IN}$	$V_{IN} = 5.3\text{ V to }15\text{ V}$ , $-40^\circ\text{C} < T_A < +125^\circ\text{C}$			0.25	mV/V
LOAD REGULATION	$\Delta V_{OUT}/\Delta I_{LOAD}$	$I_{LOAD} = 0\text{ mA to }5\text{ mA}$ , $-40^\circ\text{C} < T_A < +125^\circ\text{C}$ , $V_{IN} = 6\text{ V}$			0.9	mV/mA
		$I_{LOAD} = -1\text{ mA to }0\text{ mA}$ , $-40^\circ\text{C} < T_A < +125^\circ\text{C}$ , $V_{IN} = 6\text{ V}$			2	mV/mA
QUIESCENT CURRENT	$I_{IN}$	$-40^\circ\text{C} < T_A < +125^\circ\text{C}$		150	190	$\mu\text{A}$
VOLTAGE NOISE	$e_{N\text{ p-p}}$	$f = 0.1\text{ Hz to }10\text{ Hz}$		12.8		$\mu\text{V p-p}$
TURN-ON SETTLING TIME	$t_R$			20		$\mu\text{s}$
LONG-TERM STABILITY <sup>1</sup>	$\Delta V_{OUT}$	1000 hours		50		ppm
OUTPUT VOLTAGE HYSTERESIS	$\Delta V_{OUT\_HYS}$			100		ppm
RIPPLE REJECTION RATIO	RRR	$f_{IN} = 60\text{ Hz}$		-70		dB
SHORT CIRCUIT TO GND	$I_{SC}$	$V_{IN} = 5\text{ V}$		25		mA
		$V_{IN} = 15\text{ V}$		30		mA

<sup>1</sup> The long-term stability specification is noncumulative. The drift after the first 1000 hours is significantly lower than it is in the first 1000 hours.

# ADR360/ADR361/ADR363/ADR364/ADR365/ADR366

## ADR366 ELECTRICAL CHARACTERISTICS

$V_{IN} = 3.6\text{ V to }15\text{ V}$ ,  $T_A = 25^\circ\text{C}$ , unless otherwise noted.

Table 7.

Parameter	Symbol	Conditions	Min	Typ	Max	Unit
OUTPUT VOLTAGE	$V_{OUT}$	A grade	3.292	3.300	3.308	V
		B grade	3.296	3.300	3.304	V
INITIAL ACCURACY	$V_{OUTERR}$	A grade			$\pm 8$	mV
		A grade			$\pm 0.25$	%
		B grade			$\pm 4$	mV
		B grade			$\pm 0.125$	%
TEMPERATURE COEFFICIENT	$TCV_{OUT}$	A grade, $-40^\circ\text{C} < T_A < +125^\circ\text{C}$			25	ppm/ $^\circ\text{C}$
		B grade, $-40^\circ\text{C} < T_A < +125^\circ\text{C}$			9	ppm/ $^\circ\text{C}$
DROPOUT VOLTAGE	$V_{IN} - V_{OUT}$		300			mV
LINE REGULATION	$\Delta V_{OUT}/\Delta V_{IN}$	$V_{IN} = 3.6\text{ V to }15\text{ V}$ , $-40^\circ\text{C} < T_A < +125^\circ\text{C}$			0.165	mV/V
LOAD REGULATION	$\Delta V_{OUT}/\Delta I_{LOAD}$	$I_{LOAD} = 0\text{ mA to }5\text{ mA}$ , $-40^\circ\text{C} < T_A < +125^\circ\text{C}$ , $V_{IN} = 4.2\text{ V}$			0.6	mV/mA
		$I_{LOAD} = 0\text{ mA to }8\text{ mA}$ , $-40^\circ\text{C} < T_A < +125^\circ\text{C}$ , $V_{IN} \geq 4.75\text{ V}$			0.6	mV/mA
		$I_{LOAD} = -1\text{ mA to }0\text{ mA}$ , $-40^\circ\text{C} < T_A < +125^\circ\text{C}$ , $V_{IN} = 4.2\text{ V}$			1.35	mV/mA
QUIESCENT CURRENT	$I_{IN}$	$-40^\circ\text{C} < T_A < +125^\circ\text{C}$		150	190	$\mu\text{A}$
VOLTAGE NOISE	$e_{N\text{ p-p}}$	$f = 0.1\text{ Hz to }10\text{ Hz}$		9.3		$\mu\text{V p-p}$
TURN-ON SETTLING TIME	$t_R$			25		$\mu\text{s}$
LONG-TERM STABILITY <sup>1</sup>	$\Delta V_{OUT}$	1000 hours		50		ppm
OUTPUT VOLTAGE HYSTERESIS	$\Delta V_{OUT\_HYS}$			100		ppm
RIPPLE REJECTION RATIO	RRR	$f_{IN} = 60\text{ Hz}$		-70		dB
SHORT CIRCUIT TO GND	$I_{SC}$	$V_{IN} = 5\text{ V}$		25		mA
		$V_{IN} = 15\text{ V}$		30		mA

<sup>1</sup> The long-term stability specification is noncumulative. The drift after the first 1000 hours is significantly lower than it is in the first 1000 hours.



## ABSOLUTE MAXIMUM RATINGS

T<sub>A</sub> = 25°C, unless otherwise noted.

Table 8.

Parameter	Rating
Supply Voltage	18 V
Output Short-Circuit Duration to GND	
V <sub>IN</sub> < 15 V	Indefinite
V <sub>IN</sub> > 15 V	10 sec
Storage Temperature Range	–65°C to +125°C
Operating Temperature Range	–40°C to +125°C
Junction Temperature Range	–65°C to +150°C
Lead Temperature (Soldering, 60 sec)	300°C

Stresses above those listed under Absolute Maximum Ratings may cause permanent damage to the device. This is a stress rating only; functional operation of the device at these or any other conditions above those indicated in the operational section of this specification is not implied. Exposure to absolute maximum rating conditions for extended periods may affect device reliability.

## THERMAL RESISTANCE

θ<sub>JA</sub> is specified for the worst-case conditions, that is, a device soldered in a circuit board for surface-mount packages.

Table 9. Thermal Resistance

Package Type	θ <sub>JA</sub>	θ <sub>JC</sub>	Unit
5-Lead TSOT (UJ)	230	146	°C/W

## ESD CAUTION



**ESD (electrostatic discharge) sensitive device.** Charged devices and circuit boards can discharge without detection. Although this product features patented or proprietary protection circuitry, damage may occur on devices subjected to high energy ESD. Therefore, proper ESD precautions should be taken to avoid performance degradation or loss of functionality.

## TYPICAL PERFORMANCE CHARACTERISTICS



Figure 2. ADR360 Output Voltage vs. Temperature

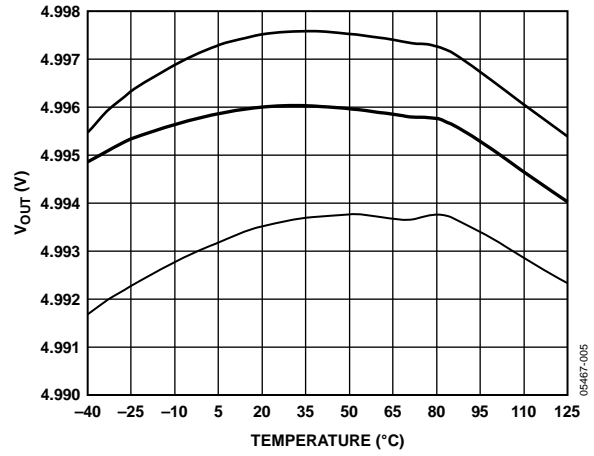

Figure 5. ADR365 Output Voltage vs. Temperature



Figure 3. ADR361 Output Voltage vs. Temperature

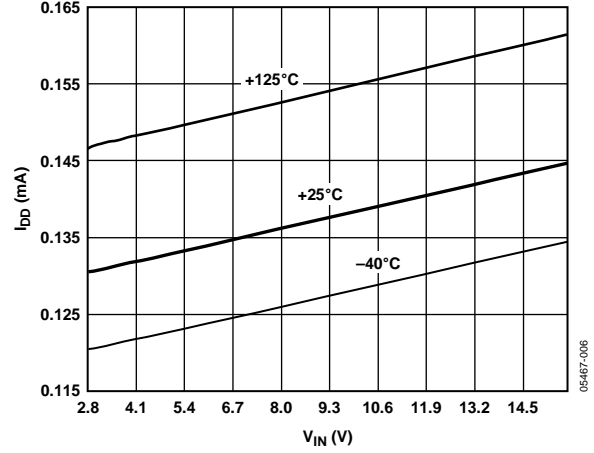

Figure 6. ADR361 Supply Current vs. Input Voltage



Figure 4. ADR363 Output Voltage vs. Temperature

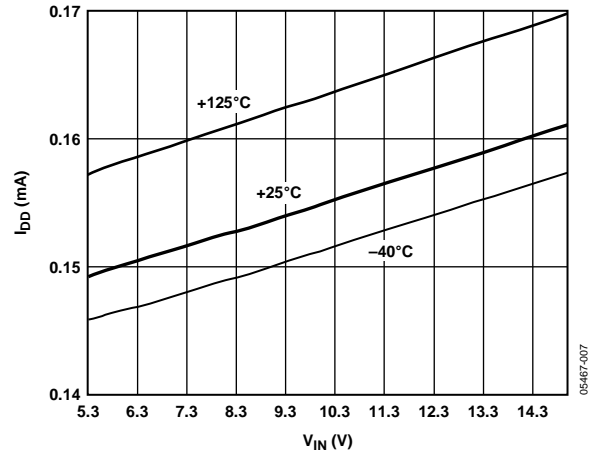

Figure 7. ADR365 Supply Current vs. Input Voltage

# ADR360/ADR361/ADR363/ADR364/ADR365/ADR366



Figure 8. ADR361 Load Regulation vs. Temperature



Figure 11. ADR361 Line Regulation vs. Temperature,  $V_{IN} = 2.8\text{ V to }15\text{ V}$



Figure 9. ADR365 Load Regulation vs. Temperature



Figure 12. ADR365 Line Regulation vs. Temperature,  $V_{IN} = 5.3\text{ V to }15\text{ V}$



Figure 10. ADR360 Line Regulation vs. Temperature,  $V_{IN} = 2.45\text{ V to }15\text{ V}$



Figure 13. ADR361 Dropout Voltage vs. Load Current

# ADR360/ADR361/ADR363/ADR364/ADR365/ADR366

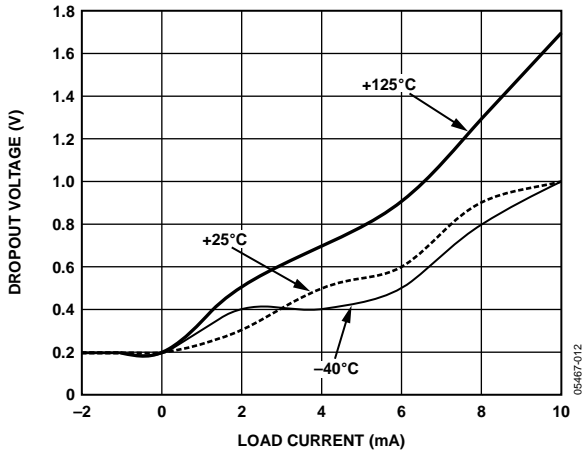

Figure 14. ADR365 Dropout Voltage vs. Load Current

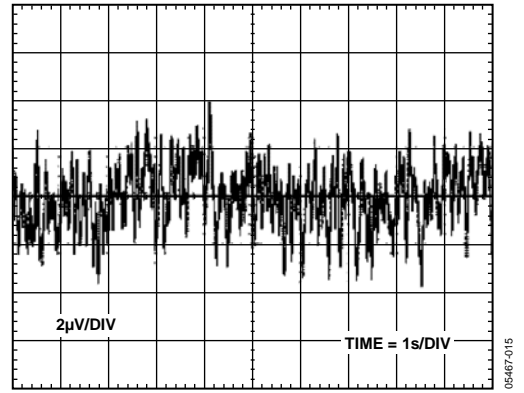

Figure 17. ADR363 0.1 Hz to 10 Hz Noise

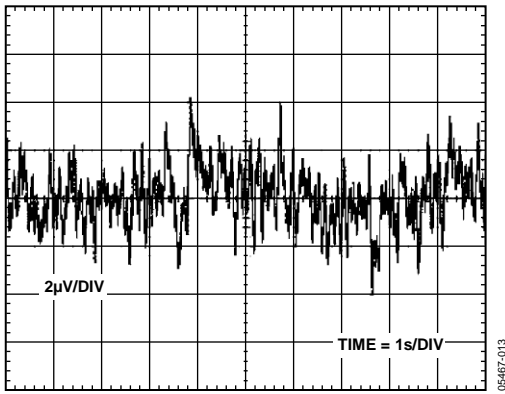

Figure 15. ADR361 0.1 Hz to 10 Hz Noise

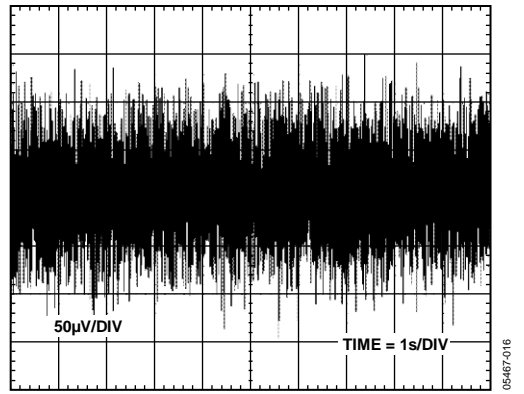

Figure 18. ADR363 10 Hz to 10 kHz Noise

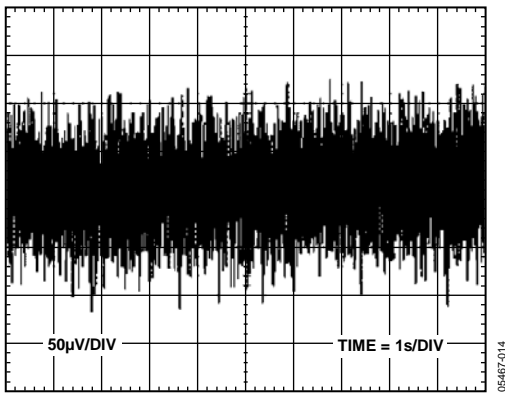

Figure 16. ADR361 10 Hz to 10 kHz Noise

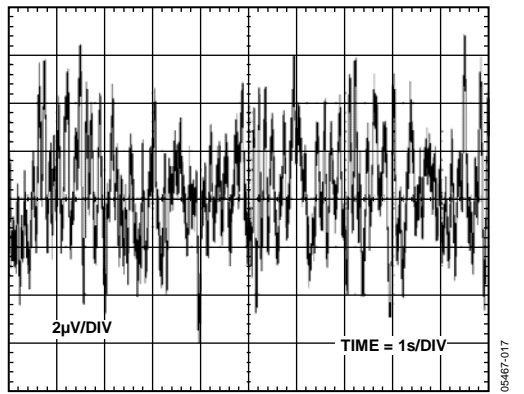

Figure 19. ADR365 0.1 Hz to 10 Hz Noise

# ADR360/ADR361/ADR363/ADR364/ADR365/ADR366

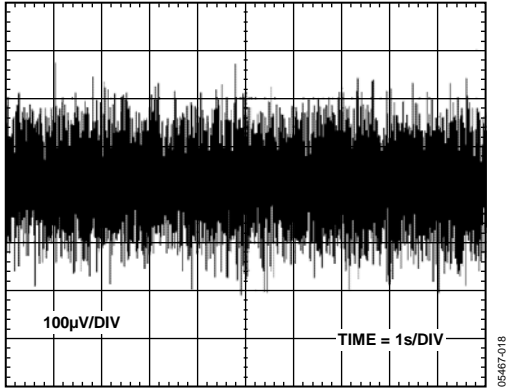

Figure 20. ADR365 10 Hz to 10 kHz Noise

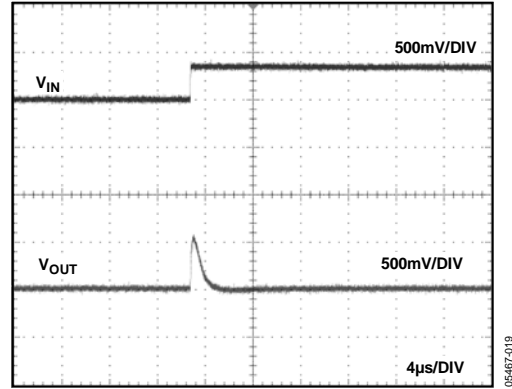

Figure 23. ADR361 Line Transient Response (Increasing), No Capacitors

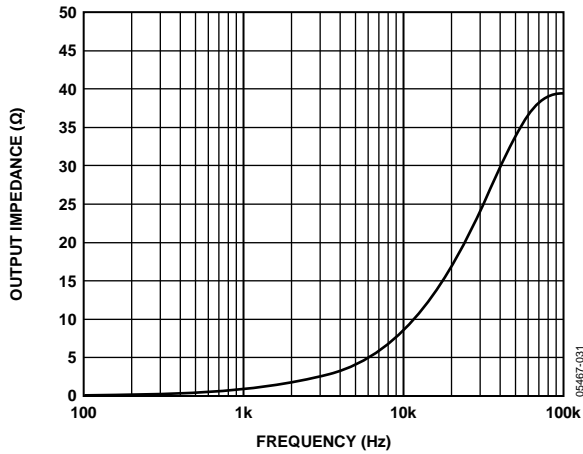

Figure 21. Output Impedance vs. Frequency

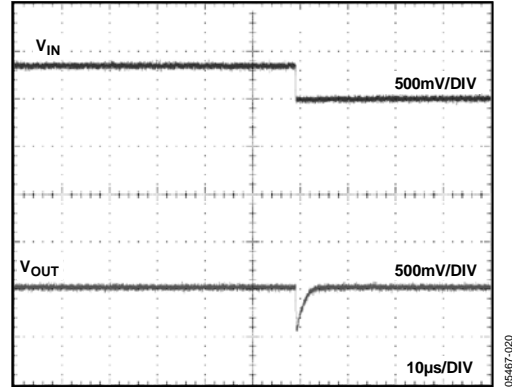

Figure 24. ADR361 Line Transient Response (Decreasing), No Capacitors

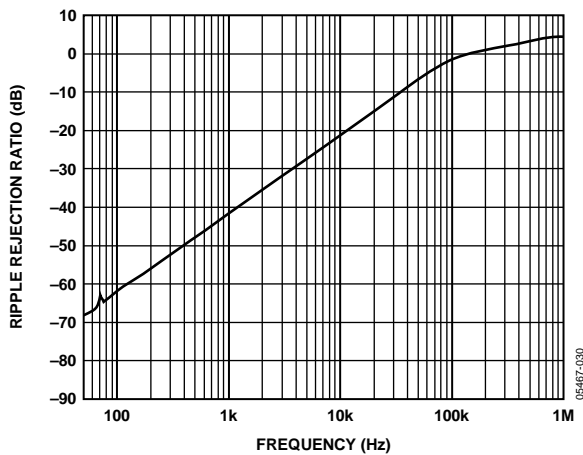

Figure 22. Ripple Rejection Ratio vs. Frequency

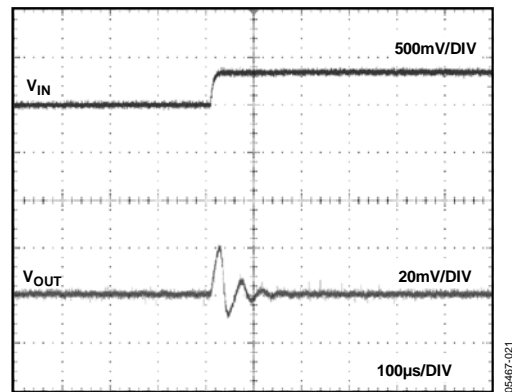

Figure 25. ADR361 Line Transient Response, 0.1 µF Input Capacitor

# ADR360/ADR361/ADR363/ADR364/ADR365/ADR366

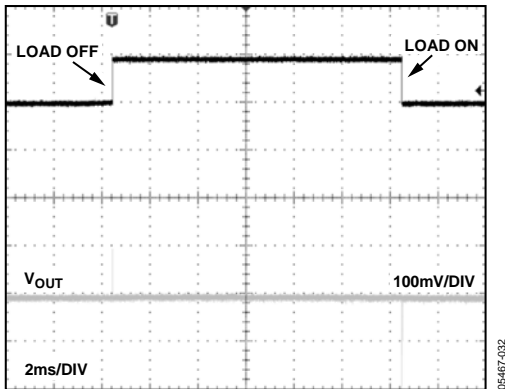

Figure 26. ADR361 Load Transient Response

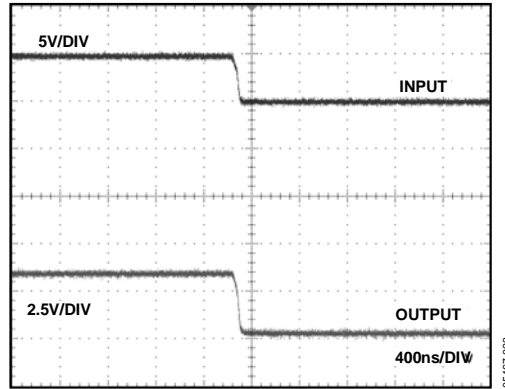

Figure 29. ADR361 Turn-Off Response Time at 5 V

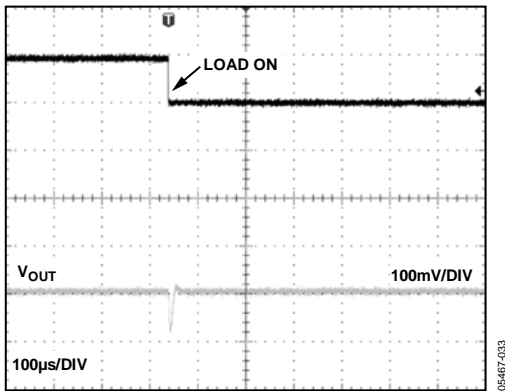

Figure 27. ADR361 Load Transient Response with 0.1  $\mu$ F Output Capacitor

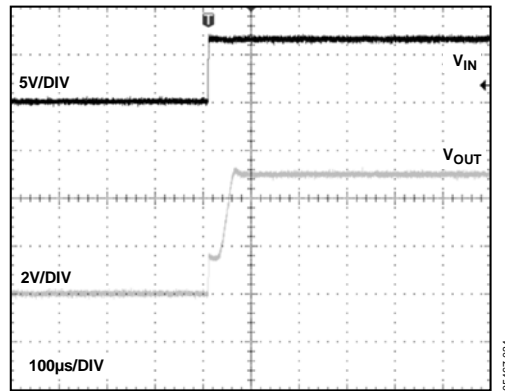

Figure 30. ADR361 Turn-On Response Time, 0.1  $\mu$ F Output Capacitor

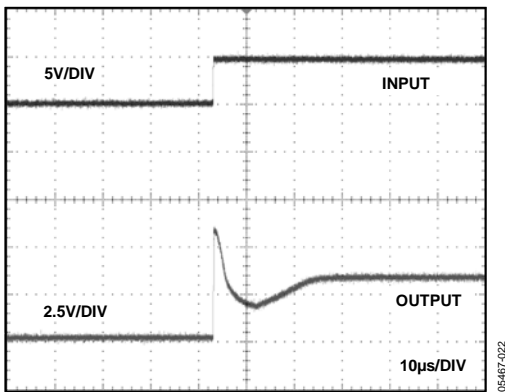

Figure 28. ADR361 Turn-On Response Time at 5 V

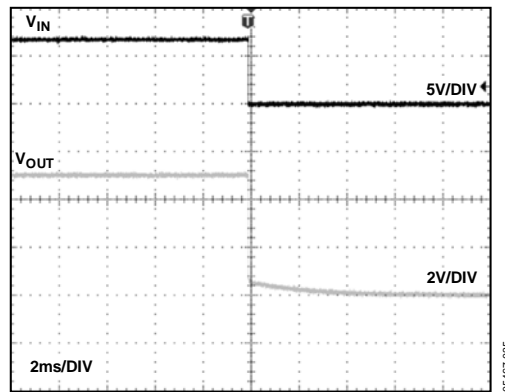

Figure 31. ADR361 Turn-Off Response Time, 0.1  $\mu$ F Output Capacitor

## TERMINOLOGY

### Temperature Coefficient

The change of output voltage with respect to operating temperature changes normalized by the output voltage at 25°C. This parameter is expressed in ppm/°C and can be determined by

$$TCV_{OUT}[\text{ppm}/^{\circ}\text{C}] = \frac{V_{OUT}(T_2) - V_{OUT}(T_1)}{V_{OUT}(25^{\circ}\text{C}) \times (T_2 - T_1)} \times 10^6$$

where:

$V_{OUT}(25^{\circ}\text{C}) = V_{OUT}$  at 25°C.

$V_{OUT}(T_1) = V_{OUT}$  at Temperature 1.

$V_{OUT}(T_2) = V_{OUT}$  at Temperature 2.

### Line Regulation

The change in output voltage due to a specified change in input voltage. This parameter accounts for the effects of self-heating. Line regulation is expressed in either percent per volt, parts per million per volt, or microvolts per volt change in input voltage.

### Load Regulation

The change in output voltage due to a specified change in load current. This parameter accounts for the effects of self-heating. Load regulation is expressed in either microvolts per milliampere, parts per million per milliampere, or ohms of dc output resistance.

### Long-Term Stability

The typical shift of output voltage at 25°C on a sample of parts subjected to a test of 1000 hours at 25°C.

$$\Delta V_{OUT} = V_{OUT}(t_0) - V_{OUT}(t_1)$$

$$\Delta V_{OUT}[\text{ppm}] = \left( \frac{V_{OUT}(t_0) - V_{OUT}(t_1)}{V_{OUT}(t_0)} \times 10^6 \right)$$

where:

$V_{OUT}(t_0) = V_{OUT}$  at 25°C at Time 0.

$V_{OUT}(t_1) = V_{OUT}$  at 25°C after 1000 hours operation at 25°C.

### Thermal Hysteresis

The change of output voltage after the device is cycled from +25°C to -40°C to +125°C and back to +25°C. This is a typical value from a sample of parts put through such a cycle.

$$V_{OUT\_HYS} = V_{OUT}(25^{\circ}\text{C}) - V_{OUT\_TC}$$

$$V_{OUT\_HYS}[\text{ppm}] = \frac{V_{OUT}(25^{\circ}\text{C}) - V_{OUT\_TC}}{V_{OUT}(25^{\circ}\text{C})} \times 10^6$$

where:

$V_{OUT}(25^{\circ}\text{C}) = V_{OUT}$  at 25°C.

$V_{OUT\_TC} = V_{OUT}$  at 25°C after temperature cycle at +25°C to -40°C to +125°C and back to +25°C.

# ADR360/ADR361/ADR363/ADR364/ADR365/ADR366

## THEORY OF OPERATION

Band gap references are the high performance solution for low supply voltage and low power voltage reference applications, and the ADR36x family is no exception. The uniqueness of these products lies in their architecture. The ideal zero TC band gap voltage is referenced to the output, not to ground (see Figure 32). Therefore, if noise exists on the ground line, it is greatly attenuated on  $V_{OUT}$ . The band gap cell consists of the PNP pair Q53 and Q52 running at unequal current densities. The difference in  $V_{BE}$  results in a voltage with a positive TC, which is amplified by a ratio of

$$2 \times \frac{R59}{R54}$$

This PTAT voltage, combined with the  $V_{BE}$  of Q53 and Q52, produces the stable band gap voltage.

Reduction in the band gap curvature is performed by the ratio of Resistor R44 and Resistor R59, one of which is linearly temperature dependent. Precision laser trimming and other patented circuit techniques are used to further enhance the drift performance.



Figure 32. Simplified Schematic

## DEVICE POWER DISSIPATION CONSIDERATIONS

The ADR36x family is capable of delivering load currents to 5 mA with an input voltage ranging from 2.348 V (ADR360 only) to 18 V. When this device is used in applications with large input voltages, care should be taken to avoid exceeding the specified maximum power dissipation or junction temperature because it may result in premature device failure. Use the following formula to calculate a device's maximum junction temperature or dissipation:

$$P_D = \frac{T_J - T_A}{\theta_{JA}}$$

where:

$T_J$  and  $T_A$  are the junction and ambient temperatures, respectively.

$P_D$  is the device power dissipation.

$\theta_{JA}$  is the device package thermal resistance.

## INPUT CAPACITOR

Input capacitors are not required on the ADR36x. There is no limit for the value of the capacitor used on the input, but a 1  $\mu$ F to 10  $\mu$ F capacitor on the input improves transient response in applications where the supply suddenly changes. An additional 0.1  $\mu$ F capacitor in parallel also helps reduce noise from the supply.

## OUTPUT CAPACITOR

The ADR36x does not require output capacitors for stability under any load condition. An output capacitor, typically 0.1  $\mu$ F, filters out low level noise voltage and does not affect the operation of the part. On the other hand, the load transient response can improve with an additional 1  $\mu$ F to 10  $\mu$ F output capacitor placed in parallel with the 0.1  $\mu$ F capacitor. The additional capacitor acts as a source of stored energy for a sudden increase in load current, and the only parameter that degrades is the turn-on time. The amount of degradation depends on the size of the capacitor chosen.



## APPLICATIONS INFORMATION

### BASIC VOLTAGE REFERENCE CONNECTION

The circuit in Figure 33 illustrates the basic configuration for the ADR36x family. Decoupling capacitors are not required for circuit stability. The ADR36x family is capable of driving capacitive loads from 0  $\mu$ F to 10  $\mu$ F. However, a 0.1  $\mu$ F ceramic output capacitor is recommended to absorb and deliver the charge, as is required by a dynamic load.

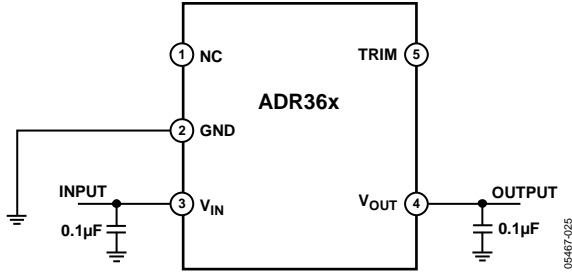

Figure 33. Basic Configuration for the ADR36x Family

### Stacking Reference ICs for Arbitrary Outputs

Some applications require two reference voltage sources, which are a combined sum of standard outputs. Figure 34 shows how this stacked output reference can be implemented.



Figure 34. Stacking Voltage References with the ADR36x

Two reference ICs are used and fed from an unregulated input,  $V_{IN}$ . The outputs of the individual ICs are connected in series, which provides two output voltages,  $V_{OUT1}$  and  $V_{OUT2}$ .  $V_{OUT1}$  is the terminal voltage of U1, and  $V_{OUT2}$  is the sum of this voltage and the terminal voltage of U2. U1 and U2 are chosen for the two voltages that supply the required outputs (see Table 10). For example, if both U1 and U2 are ADR361s,  $V_{OUT1}$  is 2.5 V and  $V_{OUT2}$  is 5.0 V.

Table 10. Output

U1/U2	$V_{OUT1}$ (V)	$V_{OUT2}$ (V)
ADR361/ADR365	2.5	7.5
ADR361/ADR361	2.5	5.0
ADR365/ADR361	5	7.5

### Negative Precision Reference Without Precision Resistors

A negative reference is easily generated by adding an op amp, A1 (see Figure 35).  $V_{OUTF}$  and  $V_{OUTS}$  are at virtual ground and therefore the negative reference can be taken directly from the output of the op amp. The op amp must be dual-supply, low offset, and rail-to-rail if the negative supply voltage is close to the reference output.

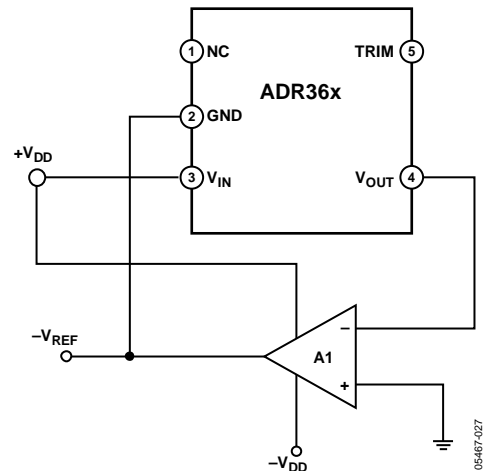

Figure 35. Negative Reference

# ADR360/ADR361/ADR363/ADR364/ADR365/ADR366

## General-Purpose Current Source

Often in low power applications, the need arises for a precision current source that can operate on low supply voltages. The ADR36x can be configured as a precision current source (see Figure 36). The circuit configuration illustrated is a floating current source with a grounded load. The output voltage of the reference is bootstrapped across  $R_{SET}$ , which sets the output current of the load. With this configuration, circuit precision is maintained for load currents ranging from the reference's supply current, typically  $150\ \mu\text{A}$ , up to approximately  $5\ \text{mA}$ .

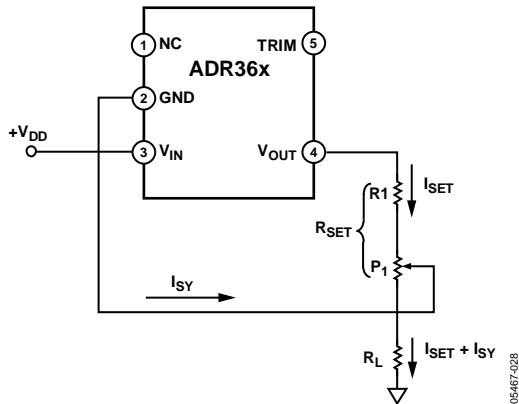

Figure 36. Precision Current Source

## Trim Terminal

The ADR36x trim terminal can be used to adjust the output voltage over a nominal voltage. This feature allows a system designer to trim system errors by setting the reference to a voltage other than the standard voltage option. Resistor R1 is used for fine adjustments and can be omitted if desired. The resistor values should be carefully chosen to ensure that the maximum current drive of the part is not exceeded.



Figure 37. ADR36x Trim Configuration

OUTLINE DIMENSIONS

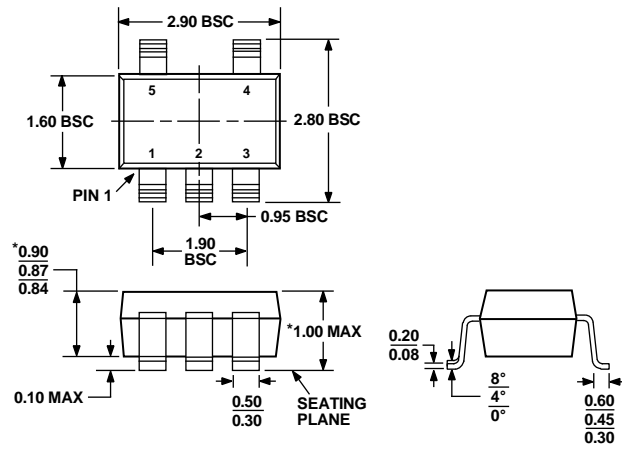

\*COMPLIANT TO JEDEC STANDARDS MO-193-AB WITH THE EXCEPTION OF PACKAGE HEIGHT AND THICKNESS.

Figure 38. 5-Lead Thin Small Outline Transistor Package [TSOT] (UJ-5)

Dimensions shown in millimeters

# ADR360/ADR361/ADR363/ADR364/ADR365/ADR366

## ORDERING GUIDE

Model <sup>1,2</sup>	Output Voltage (V <sub>out</sub> )	Initial Accuracy, ±		Temperature Coefficient (ppm/°C)	Package Description	Package Option	Temperature Range	Ordering Quantity	Branding
		(mV)	(%)						
ADR360AUJZ-REEL7	2.048	6	0.29	25	5-Lead TSOT	UJ-5	-40°C to +125°C	3,000	ROC
ADR360AUJZ-R2	2.048	6	0.29	25	5-Lead TSOT	UJ-5	-40°C to +125°C	250	ROC
ADR360BUJZ-REEL7	2.048	3	0.15	9	5-Lead TSOT	UJ-5	-40°C to +125°C	3,000	ROD
ADR360BUJZ-R2	2.048	3	0.15	9	5-Lead TSOT	UJ-5	-40°C to +125°C	250	ROD
ADR361AUJZ-REEL7	2.5	6	0.24	25	5-Lead TSOT	UJ-5	-40°C to +125°C	3,000	ROE
ADR361AUJZ-R2	2.5	6	0.24	25	5-Lead TSOT	UJ-5	-40°C to +125°C	250	ROE
ADR361BUJZ-REEL7	2.5	3	0.12	9	5-Lead TSOT	UJ-5	-40°C to +125°C	3,000	ROF
ADR361BUJZ-R2	2.5	3	0.12	9	5-Lead TSOT	UJ-5	-40°C to +125°C	250	ROF
ADR363AUJZ-REEL7	3.0	6	0.2	25	5-Lead TSOT	UJ-5	-40°C to +125°C	3,000	ROG
ADR363AUJZ-R2	3.0	6	0.2	25	5-Lead TSOT	UJ-5	-40°C to +125°C	250	ROG
ADR363BUJZ-REEL7	3.0	3	0.1	9	5-Lead TSOT	UJ-5	-40°C to +125°C	3,000	ROH
ADR363BUJZ-R2	3.0	3	0.1	9	5-Lead TSOT	UJ-5	-40°C to +125°C	250	ROH
ADR364AUJZ-REEL7	4.096	8	0.2	25	5-Lead TSOT	UJ-5	-40°C to +125°C	3,000	ROJ
ADR364AUJZ-R2	4.096	8	0.2	25	5-Lead TSOT	UJ-5	-40°C to +125°C	250	ROJ
ADR364BUJZ-REEL7	4.096	4	0.1	9	5-Lead TSOT	UJ-5	-40°C to +125°C	3,000	ROK
ADR364BUJZ-R2	4.096	4	0.1	9	5-Lead TSOT	UJ-5	-40°C to +125°C	250	ROK
ADR365AUJZ-REEL7	5.0	8	0.16	25	5-Lead TSOT	UJ-5	-40°C to +125°C	3,000	ROL
ADR365AUJZ-R2	5.0	8	0.16	25	5-Lead TSOT	UJ-5	-40°C to +125°C	250	ROL
ADR365BUJZ-REEL7	5.0	4	0.08	9	5-Lead TSOT	UJ-5	-40°C to +125°C	3,000	ROM
ADR365BUJZ-R2	5.0	4	0.08	9	5-Lead TSOT	UJ-5	-40°C to +125°C	250	ROM
ADR365WAUJZ-R7	5.0	8	0.16	25	5-Lead TSOT	UJ-5	-40°C to +125°C	3,000	ROL
ADR365WAUJZ-RL	5.0	8	0.16	25	5-Lead TSOT	UJ-5	-40°C to +125°C	10,000	ROL
ADR366AUJZ-REEL7	3.3	8	0.25	25	5-Lead TSOT	UJ-5	-40°C to +125°C	3,000	R08
ADR366AUJZ-R2	3.3	8	0.25	25	5-Lead TSOT	UJ-5	-40°C to +125°C	250	R08
ADR366BUJZ-REEL7	3.3	4	0.125	9	5-Lead TSOT	UJ-5	-40°C to +125°C	3,000	R09
ADR366BUJZ-R2	3.3	4	0.125	9	5-Lead TSOT	UJ-5	-40°C to +125°C	250	R09
ADR366WAUJZ-REEL7	3.3	8	0.25	25	5-Lead TSOT	UJ-5	-40°C to +125°C	3,000	R08

<sup>1</sup> Z = RoHS Compliant Part.

<sup>2</sup> W = Qualified for Automotive Applications.

## AUTOMOTIVE PRODUCTS

The ADR365W and ADR366W models are available with controlled manufacturing to support the quality and reliability requirements of automotive applications. Note that these automotive models may have specifications that differ from the commercial models; therefore, designers should review the Specifications section of this data sheet carefully. Only the automotive grade products shown are available for use in automotive applications. Contact your local Analog Devices account representative for specific product ordering information and to obtain the specific Automotive Reliability reports for these models.



Компания «ЭлектроПласт» предлагает заключение долгосрочных отношений при поставках импортных электронных компонентов на взаимовыгодных условиях!

Наши преимущества:

- Оперативные поставки широкого спектра электронных компонентов отечественного и импортного производства напрямую от производителей и с крупнейших мировых складов;
- Поставка более 17-ти миллионов наименований электронных компонентов;
- Поставка сложных, дефицитных, либо снятых с производства позиций;
- Оперативные сроки поставки под заказ (от 5 рабочих дней);
- Экспресс доставка в любую точку России;
- Техническая поддержка проекта, помощь в подборе аналогов, поставка прототипов;
- Система менеджмента качества сертифицирована по Международному стандарту ISO 9001;
- Лицензия ФСБ на осуществление работ с использованием сведений, составляющих государственную тайну;
- Поставка специализированных компонентов (Xilinx, Altera, Analog Devices, Intersil, Interpoint, Microsemi, Aeroflex, Peregrine, Syfer, Eurofarad, Texas Instrument, Miteq, Cobham, E2V, MA-COM, Hittite, Mini-Circuits, General Dynamics и др.);

Помимо этого, одним из направлений компании «ЭлектроПласт» является направление «Источники питания». Мы предлагаем Вам помощь Конструкторского отдела:

- Подбор оптимального решения, техническое обоснование при выборе компонента;
- Подбор аналогов;
- Консультации по применению компонента;
- Поставка образцов и прототипов;
- Техническая поддержка проекта;
- Защита от снятия компонента с производства.



#### Как с нами связаться

**Телефон:** 8 (812) 309 58 32 (многоканальный)

**Факс:** 8 (812) 320-02-42

**Электронная почта:** [org@eplast1.ru](mailto:org@eplast1.ru)

**Адрес:** 198099, г. Санкт-Петербург, ул. Калинина, дом 2, корпус 4, литера А.