

Qxx40xx Series



Agency Approval

Agency	Agency File Number
	K & J Packages: E71639

Main Features

Symbol	Value	Unit
$I_{T(RMS)}$	40	A
V_{DRM}/V_{RRM}	400 to 1000	V
$I_{GT(Q1)}$	50 to 100	mA

Schematic Symbol



Description

The 40 Amp bi-directional solid state switch series is designed for AC switching and phase control applications such as motor speed, temperature modulation controls, lighting controls, and static switching relays.

Alternistor type devices only operate in quadrants I, II, & III and are used in circuits requiring high dv/dt capability.

Features & Benefits

- RoHS Compliant
- Glass – passivated junctions
- Voltage capability up to 1000V
- Surge capability up to 400A
- Electrically isolated K & J -Packages are UL recognized for 2500Vrms

Applications

Excellent for AC switching and phase control applications such as heating, lighting, and motor speed controls.

Typical applications are AC solid-state switches, industrial power tools, exercise equipment, white goods and commercial appliances.

Alternistor Triacs (no snubber required) are used in applications with extremely inductive loads requiring highest commutation performance.

Internally constructed isolated packages are offered for ease of heat sinking with highest isolation voltage.

Additional Information



Datasheet



Resources



Samples

Absolute Maximum Ratings — Alternistor Triac (3 Quadrants)

Symbol	Parameter			Value	Unit
$I_{T(RMS)}$	RMS on-state current (full sine wave)	Qxx40x7 Qxx40xH6	$T_C = 75^\circ\text{C}$	40	A
I_{TSM}	Non repetitive surge peak on-state current (full cycle, T_J initial = 25°C)	f = 50 Hz	t = 20 ms	335	A
		f = 60 Hz	t = 16.7 ms	400	
I^2t	I ² t Value for fusing		$t_p = 8.3$ ms	664	A ² s
di/dt	Critical rate of rise of on-state current ($I_G = 2 \times I_{GT}$, tr ≤ 100 ns)	f = 120 Hz	$T_J = 125^\circ\text{C}$	150	A/μs
I_{GTM}	Peak gate trigger current	$t_p \leq 10$ μs $I_{GT} \leq I_{GTM}$	$T_J = 125^\circ\text{C}$	4	A
$P_{G(AV)}$	Average gate power dissipation		$T_J = 125^\circ\text{C}$	0.8	W
T_{stg}	Storage temperature range			-40 to 150	°C
T_J	Operating junction temperature range			-40 to 125	°C

Note: xx = voltage, x = package

Electrical Characteristics ($T_J = 25^\circ\text{C}$, unless otherwise specified) — Alternistor Triac (3 Quadrants)

Symbol	Test Conditions	Quadrant		Value			Unit
				Qxx40xH6	Qxx40K5	Qxx40x7	
I_{GT}	$V_D = 12\text{V}$ $R_L = 60 \Omega$	I – II – III	MAX.	80	50	100	mA
V_{GT}	$V_D = 12\text{V}$ $R_L = 60 \Omega$	I – II – III	MAX.	1.3	1.3	2.0	V
V_{GD}	$V_D = V_{DRM}$ $R_L = 3.3 \text{k}\Omega$ $T_J = 125^\circ\text{C}$	I – II – III	MIN.	0.2			V
I_H	$I_T = 400\text{mA}$		MAX.	80	75	100	mA
dv/dt	$V_D = V_{DRM}$ Gate Open $T_J = 125^\circ\text{C}$	400V	MIN.	600	500	700	V/μs
		600V		500	475	625	
		800V		475	400	575	
	$V_D = V_{DRM}$ Gate Open $T_J = 100^\circ\text{C}$	1000V			--	500	
(dv/dt)c	(di/dt)c = 21.6 A/ms $T_J = 125^\circ\text{C}$		MIN.	30	20	50	V/μs
t_{gt}	$I_G = 2 \times I_{GT}$ PW = 15μs $I_T = 56.6\text{A(pk)}$		TYP.	5			μs

Static Characteristics

Symbol	Test Conditions			Value	Unit	
V_{TM}	$I_{TM} = 56.6\text{A}$ $t_p = 380$ μs	$T_J = 25^\circ\text{C}$	MAX.	1.8	V	
I_{RRM}^{DRM}	$V_D = V_{DRM} / V_{RRM}$	$T_J = 25^\circ\text{C}$	400 – 1000V	MAX.	20	μA
		$T_J = 125^\circ\text{C}$	400 – 800V	MAX.	5	mA
		$T_J = 100^\circ\text{C}$	1000V	MAX.	5	mA

Thermal Resistances

Symbol	Parameter		Value	Unit
$R_{\theta(J-C)}$	Junction to case (AC)	Qxx40KH6 Qxx40K5 Qxx40K7	0.97	°C/W
		Qxx40JH6 Qxx40J7	0.95	

Note: xx = voltage

Figure 1: Definition of Quadrants



Note: Alternistors will not operate in QIV

Figure 3: Normalized DC Holding Current vs. Junction Temperature

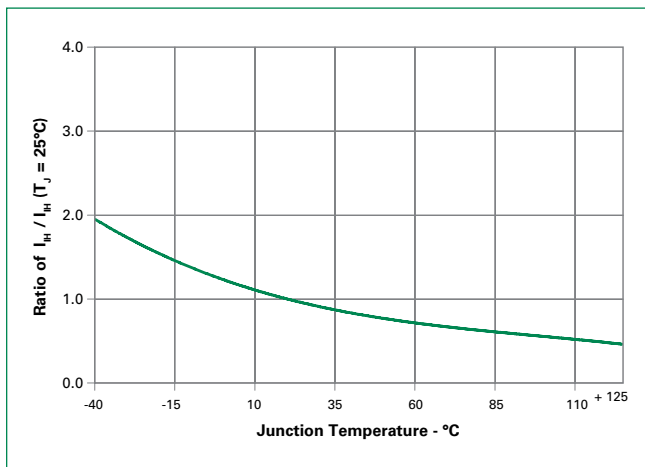

Figure 5: Power Dissipation (Typical) vs. RMS On-State Current

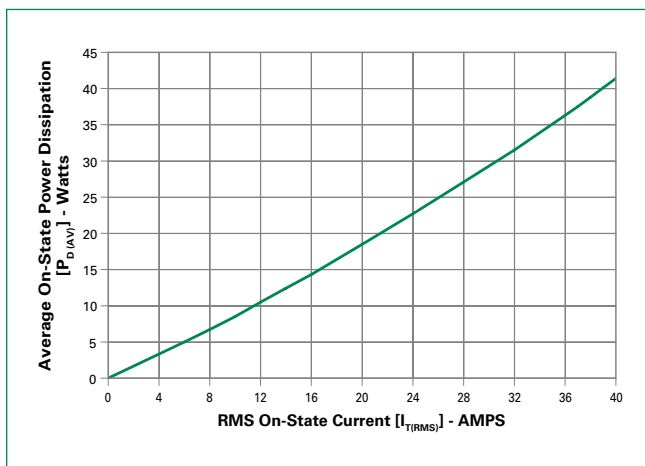

Figure 2: Normalized DC Gate Trigger Current for All Quadrants vs. Junction Temperature

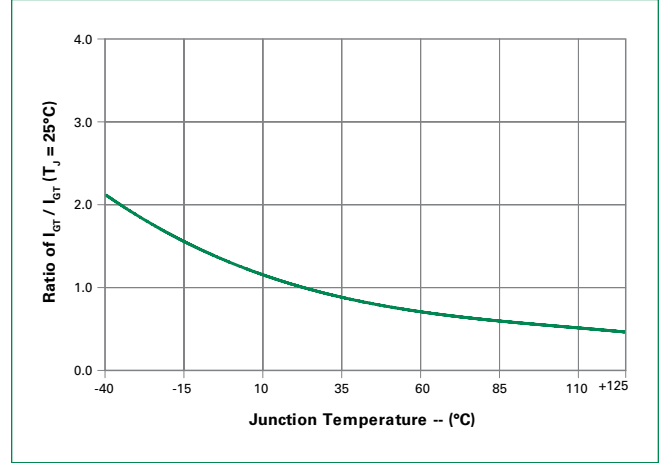

Figure 4: Normalized DC Gate Trigger Voltage for All Quadrants vs. Junction Temperature

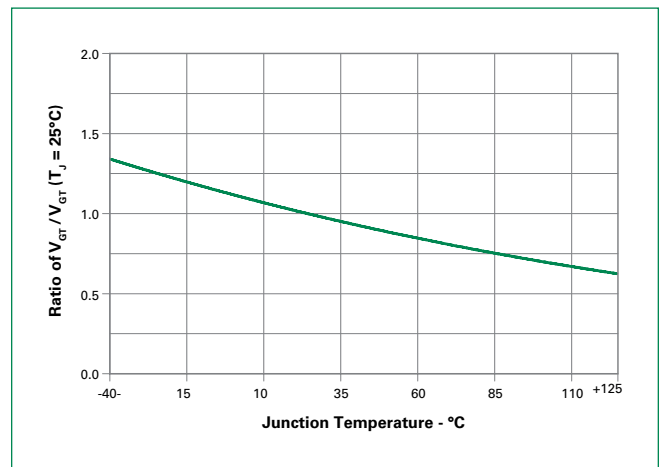

Figure 6: Maximum Allowable Case Temperature vs. On-State Current



Figure 7: On-State Current vs. On-State Voltage (Typical)



Figure 8: Surge Peak On-State Current vs. Number of Cycles

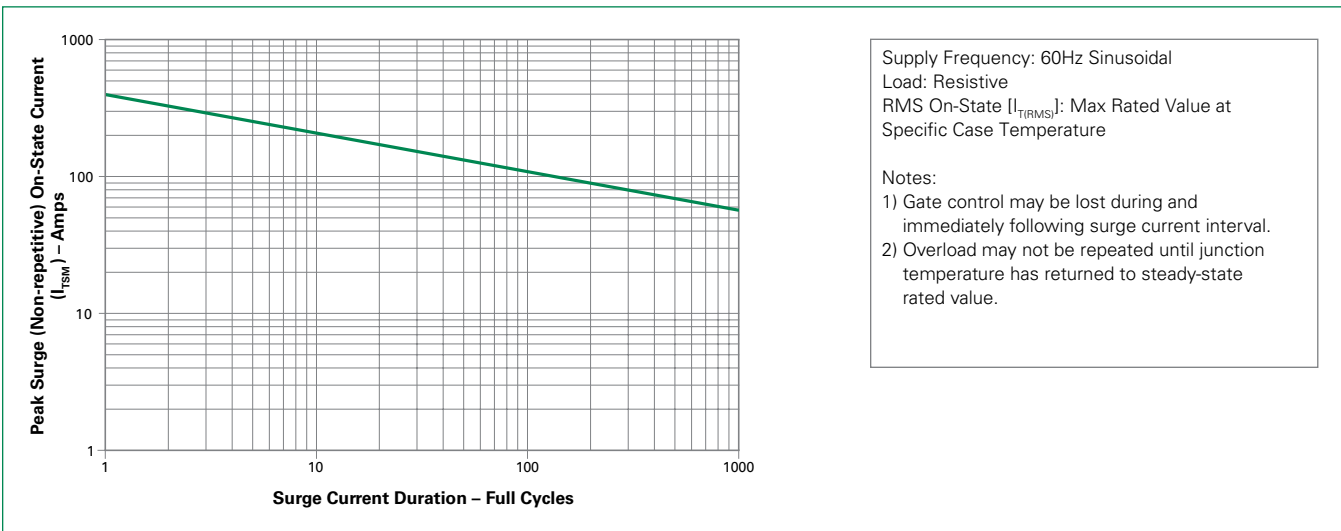

Supply Frequency: 60Hz Sinusoidal
Load: Resistive
RMS On-State [$I_{T(RMS)}$]: Max Rated Value at Specific Case Temperature

- Notes:
- 1) Gate control may be lost during and immediately following surge current interval.
 - 2) Overload may not be repeated until junction temperature has returned to steady-state rated value.

Note: xx = voltage

Soldering Parameters

Reflow Condition		Pb – Free assembly
Pre Heat	- Temperature Min ($T_{s(min)}$)	150°C
	- Temperature Max ($T_{s(max)}$)	200°C
	- Time (min to max) (t_s)	60 – 180 secs
Average ramp up rate (Liquidus Temp) (T_L) to peak		5°C/second max
$T_{s(max)}$ to T_L - Ramp-up Rate		5°C/second max
Reflow	- Temperature (T_L) (Liquidus)	217°C
	- Time (min to max) (t_s)	60 – 150 seconds
Peak Temperature (T_p)		260 ^{+0/-5} °C
Time within 5°C of actual peak Temperature (t_p)		20 – 40 seconds
Ramp-down Rate		5°C/second max
Time 25°C to peak Temperature (T_p)		8 minutes Max.
Do not exceed		280°C



Physical Specifications

Terminal Finish	100% Matte Tin-plated.
Body Material	UL recognized epoxy meeting flammability classification 94V-0.
Lead Material	Copper Alloy

Design Considerations

Careful selection of the correct device for the application's operating parameters and environment will go a long way toward extending the operating life of the Thyristor. Good design practice should limit the maximum continuous current through the main terminals to 75% of the device rating. Other ways to ensure long life for a power discrete semiconductor are proper heat sinking and selection of voltage ratings for worst case conditions. Overheating, overvoltage (including dv/dt), and surge currents are the main killers of semiconductors. Correct mounting, soldering, and forming of the leads also help protect against component damage.

Environmental Specifications

Test	Specifications and Conditions
AC Blocking	MIL-STD-750, M-1040, Cond A Applied Peak AC voltage @ 125°C for 1008 hours
Temperature Cycling	MIL-STD-750, M-1051, 100 cycles; -40°C to +150°C; 15-min dwell-time
Temperature/Humidity	EIA / JEDEC, JESD22-A101 1008 hours; 320V - DC: 85°C; 85% rel humidity
High Temp Storage	MIL-STD-750, M-1031, 1008 hours; 150°C
Low-Temp Storage	1008 hours; -40°C
Resistance to Solder Heat	MIL-STD-750 Method 2031
Solderability	ANSI/J-STD-002, category 3, Test A
Lead Bend	MIL-STD-750, M-2036 Cond E

Dimensions — TO-218X (J Package) — Isolated Mounting Tab



Dimension	Inches		Millimeters	
	Min	Max	Min	Max
A	0.810	0.835	20.57	21.21
B	0.610	0.630	15.49	16.00
C	0.178	0.188	4.52	4.78
D	0.055	0.070	1.40	1.78
E	0.487	0.497	12.37	12.62
F	0.635	0.655	16.13	16.64
G	0.022	0.029	0.56	0.74
H	0.075	0.095	1.91	2.41
J	0.575	0.625	14.61	15.88
K	0.256	0.264	6.50	6.71
L	0.220	0.228	5.58	5.79
M	0.080	0.088	2.03	2.24
N	0.169	0.177	4.29	4.49
P	0.034	0.042	0.86	1.07
R	0.113	0.121	2.87	3.07
S	0.086	0.096	2.18	2.44
T	0.156	0.166	3.96	4.22
U	0.161	0.165	4.10	4.20
V	0.603	0.618	15.31	15.70
W	0.000	0.005	0.00	0.13
X	0.003	0.012	0.07	0.30
Y	0.028	0.032	0.71	0.81
Z	0.085	0.095	2.17	2.42

Dimensions — TO-218AC (K Package) — Isolated Mounting Tab



Dimension	Inches		Millimeters	
	Min	Max	Min	Max
A	0.810	0.835	20.57	21.21
B	0.610	0.630	15.49	16.00
C	0.178	0.188	4.52	4.78
D	0.055	0.070	1.40	1.78
E	0.487	0.497	12.37	12.62
F	0.635	0.655	16.13	16.64
G	0.022	0.029	0.56	0.74
H	0.075	0.095	1.91	2.41
J	0.575	0.625	14.61	15.88
K	0.211	0.219	5.36	5.56
L	0.422	0.437	10.72	11.10
M	0.058	0.068	1.47	1.73
N	0.045	0.055	1.14	1.40
P	0.095	0.115	2.41	2.92
Q	0.008	0.016	0.20	0.41
R	0.008	0.016	0.20	0.41
U	0.161	0.165	4.10	4.20
W	0.085	0.095	2.17	2.42

Product Selector

Part Number	Voltage				Gate Sensitivity Quadrants		I _{T(RMS)}	Type	Package
	400V	600V	800V	1000V	I – II – III	IV			
Qxx40KH6	X	X	X	X	80mA		40A	Alternistor Triac	TO-218AC
Qxx40JH6	X	X	X		80mA		40A	Alternistor Triac	TO-218X
Qxx40K5	X	X	X		50mA		40A	Alternistor Triac	TO-218AC
Qxx40K7	X	X	X	X	100 mA		40A	Alternistor Triac	TO-218AC
Qxx40J7	X	X	X		100 mA		40A	Alternistor Triac	TO-218X

Note: xx = Voltage

Packing Options

Part Number	Marking	Weight	Packing Mode	Base Quantity
Qxx40KH6TP	Qxx40KH6	4.40g	Tube	250 (25 per tube)
Qxx40JH6TP	Qxx40JH6	5.23g	Tube	250 (25 per tube)
Qxx40K5TP	Qxx40K5	4.40g	Tube	250 (25 per tube)
Qxx40K7TP	Qxx40K7	4.40g	Tube	250 (25 per tube)
Qxx40J7TP	Qxx40J7	5.23g	Tube	250 (25 per tube)

Note: xx = Voltage

Part Numbering System

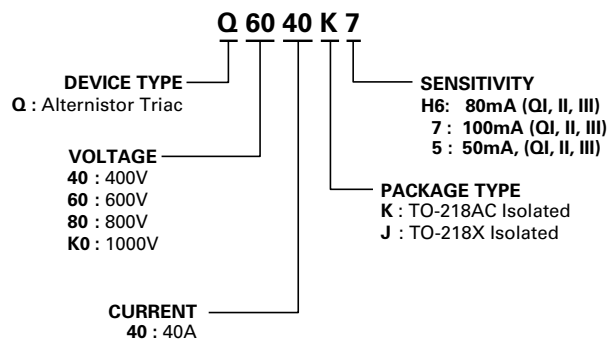

Part Marking System

TO-218 AC - (K Package)
TO-218 X - (J Package)

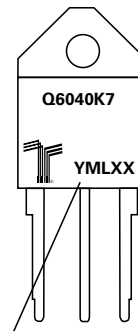

Date Code Marking
Y: Year Code
M: Month Code
L: Location Code
XX: Lot Serial Code



Компания «ЭлектроПласт» предлагает заключение долгосрочных отношений при поставках импортных электронных компонентов на взаимовыгодных условиях!

Наши преимущества:

- Оперативные поставки широкого спектра электронных компонентов отечественного и импортного производства напрямую от производителей и с крупнейших мировых складов;
- Поставка более 17-ти миллионов наименований электронных компонентов;
- Поставка сложных, дефицитных, либо снятых с производства позиций;
- Оперативные сроки поставки под заказ (от 5 рабочих дней);
- Экспресс доставка в любую точку России;
- Техническая поддержка проекта, помощь в подборе аналогов, поставка прототипов;
- Система менеджмента качества сертифицирована по Международному стандарту ISO 9001;
- Лицензия ФСБ на осуществление работ с использованием сведений, составляющих государственную тайну;
- Поставка специализированных компонентов (Xilinx, Altera, Analog Devices, Intersil, Interpoint, Microsemi, Aeroflex, Peregrine, Syfer, Eurofarad, Texas Instrument, Miteq, Cobham, E2V, MA-COM, Hittite, Mini-Circuits, General Dynamics и др.);

Помимо этого, одним из направлений компании «ЭлектроПласт» является направление «Источники питания». Мы предлагаем Вам помощь Конструкторского отдела:

- Подбор оптимального решения, техническое обоснование при выборе компонента;
- Подбор аналогов;
- Консультации по применению компонента;
- Поставка образцов и прототипов;
- Техническая поддержка проекта;
- Защита от снятия компонента с производства.



Как с нами связаться

Телефон: 8 (812) 309 58 32 (многоканальный)

Факс: 8 (812) 320-02-42

Электронная почта: org@eplast1.ru

Адрес: 198099, г. Санкт-Петербург, ул. Калинина, дом 2, корпус 4, литера А.