

THERMAL INTERFACE MATERIAL PART NUMBER GUIDE

All of the heat sinks shown in this catalog are available with any of the following thermal tape and interface materials, pre-applied at the factory. Use the “T” series, thermally enhanced, pressure sensitive adhesives to attach the heat sink to the electronic package and provide a good thermal link to the heat sink. The “S” series interface materials have adhesives on only one side, for pre-attachment to the heat sink, and provide superior thermal performance. Specify these materials in applications where the heat sink will be fixed to the electronic package by some mechanical means other than a tape. Please note that none of these materials are for use in applications requiring electrical isolation from the electronic device. All options other than -T1 and -T4 are RoHS compliant.

Note: To obtain the estimated thermal resistance of the interface material in your application, divide the thermal impedance value by the area of the pad in square inches. For example, a 2” x 2” piece of T4 has a resistance of $1.10 \text{ C-in}^2/\text{W} \div 4 \text{ in}^2 = 0.275 \text{ C/W}$

“T” SERIES THERMALLY ENHANCED PRESSURE SENSITIVE ADHESIVES

Suffix	Manufacturer Product	Thermal Impedance C-in ² /W	Thickness, Inches	Package Surface, Comments
-T1	Chomerics, T405	0.47	0.006	Metal/ceramic; aluminum carrier
-T1E	Chomerics, T405R	0.47	0.006	RoHS-compliant version of -T1
-T3	Chomerics, T412	0.25	0.009	Metal/ceramic; very good performance and conformity
-T4	Chomerics, T410	1.10	0.007	Plastic
-T4E	Chomerics, T410R	1.10	0.007	RoHS-compliant version of -T4
-T5	Chomerics, T411	1.00	0.011	Plastic; conforms to out-of-flat packages
-T6	3M, 8810	0.88	0.010	Metal/ceramic; very good adhesion and conformity
-T7	Bergquist, BP 108	1.28	0.008	Metal/ceramic; electrically insulating

“S” SERIES THERMAL INTERFACE PADS

Suffix	Manufacturer Product	Thermal Impedance C-in ² /W	Thickness, Inches	Package Surface, Comments
-S4	Berquist Softface	0.06	0.005	All surfaces; requires mechanical fasteners

ORDERING INFORMATION

Once you have chosen heat sink and thermal interface material that meets your thermal & mechanical requirements it is easy to designate the part number. Simply add the interface material suffix referenced on the chart above to the base part number for the heat sink. The base part number already includes information regarding its size and finish.

Example:

To order the 658 Series heat sink at .350” tall with the T5 thermal interface material, specify part number:

658-35AB - T5

From Catalog Page ??

From Table on Page ??

HEAT SINKS FOR BGAs, SUPER BGAs, PBGAs, and FPBGAs



624 SERIES Omnidirectional Pin Fin Heat Sink for BGAs

Standard P/N	Base Dimensions in. Sq.	Fin Height "A" in. (mm)	Typical Applications	Weight lbs. (grams)
624-25AB	.827 (21)	.250 (6.4)	21mm BGA	.009 (4.09)
624-35AB	.827 (21)	.350 (8.9)	21mm BGA	.011 (4.99)
624-45AB	.827 (21)	.450 (11.4)	21mm BGA	.015 (6.81)
624-60AB	.827 (21)	.600 (15.2)	21mm BGA	.026 (11.80)

Material: Aluminum, Black Anodized

The 624 Series is an omnidirectional pin fin heat sink for both natural and forced-convection applications.

Applications include network routers and switches, high-resolution printers, digital cameras, consumer video games, digital video disks (DVD) and global positioning systems (GPS).

PRODUCT FEATURES

- Available in four standard heights, .25 inch, .35 inch, .45 inch, and .60 inch.
- Available with pressure sensitive adhesives for quick and easy mounting. See Page 3

MECHANICAL DIMENSIONS



624 SERIES

624 THERMAL PERFORMANCE



Dimensions: in.



625 SERIES Omnidirectional Pin Fin Heat Sink for BGAs

Standard P/N	Base Dimensions in. Sq.	Fin Height "A" in. (mm)	Typical Applications	Weight lbs. (grams)
625-25AB	.984 (25)	0.250 (6.4)	25 mm BGA	.012 (5.45)
625-35AB	.984 (25)	0.350 (8.9)	25 mm BGA	.014 (6.36)
625-45AB	.984 (25)	0.450 (11.4)	25 mm BGA	.018 (8.17)
625-60AB	.984 (25)	0.600 (15.2)	25 mm BGA	.030 (13.62)

Material: Aluminum, Black Anodized

The 625 Series is an omnidirectional pin fin heat sink for both natural and forced-convection applications.

Applications include network routers and switches, high-resolution printers, digital cameras, consumer video games, digital video disks (DVD) and global positioning systems (GPS).

PRODUCT FEATURES

- Available in four standard heights, .25 inch, .35 inch, .45 inch, and .60 inch.
- Available with pressure sensitive adhesives for quick and easy mounting. See Page 3

MECHANICAL DIMENSIONS



625 SERIES

625 THERMAL PERFORMANCE

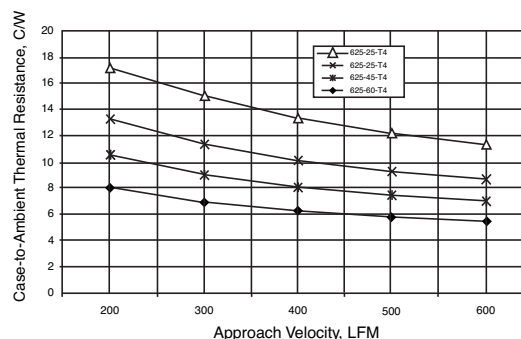

Dimensions: in.

HEAT SINKS FOR BGAs, SUPER BGAs, PBGAs, and FPBGAs



659 SERIES Unidirectional Fin Heat Sink for BGAs

Standard P/N	Base Dimensions in. (mm)	Height in. (mm)	Typical Application	Heat Sink Finish	Weight lbs. (grams)
659-65AB	1.45 (36.8) sq	0.650 (16.5)	37mm BGA	Black Anodized	0.050 (22.68)

Notes: 1. Optional factory preapplied pressure-sensitive adhesive. See Page 3

MECHANICAL DIMENSIONS



Dimensions: in. (mm)

NATURAL AND FORCED CONVECTION CHARACTERISTICS

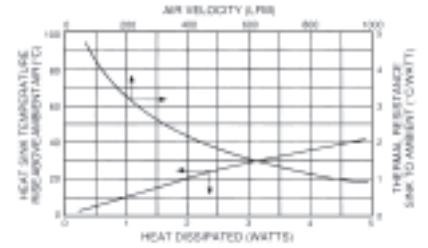

655 SERIES Omnidirectional Pin Fin Heat Sink for BGAs and PowerPC™

Standard P/N	Base Dimensions in. (mm)	Dimension "A" in. (mm)	Dimension "B" in. (mm)	Typical Applications	Heat Sink Finish	Weight lbs. (grams)
655-26AB	1.600 (40.6) sq	0.260 (6.6)	0.125 (3.2)	40mm BGA	Black Anodized	0.038 (17.01)
655-53AB	1.600 (40.6) sq	0.525 (13.3)	0.145 (3.7)	40mm BGA	Black Anodized	0.050 (22.68)

Notes: 1. Optional factory preapplied pressure-sensitive adhesive. See Page 3

MECHANICAL DIMENSIONS



Dimensions: in. (mm)

NATURAL AND FORCED CONVECTION CHARACTERISTICS

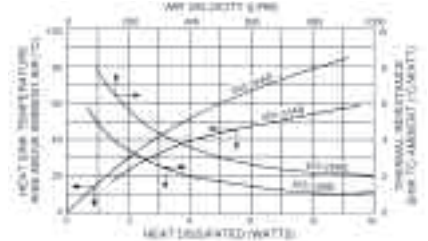

658 SERIES Omnidirectional Pin Fin Heat Sink for BGAs and PowerPC™

Standard P/N	Base Dimensions in. (mm)	Dimension "A" in. (mm)	Typical Applications	Heat Sink Finish	Weight lbs. (grams)
658-25AB	1.100 (27.9) sq	0.250 (6.4)	27mm BGA	Black Anodized	0.013 (5.67)
658-35AB	1.100 (27.9) sq	0.350 (8.9)	27mm BGA	Black Anodized	0.015 (6.70)
658-45AB	1.100 (27.9) sq	0.450 (11.4)	27mm BGA	Black Anodized	0.019 (8.50)
658-60AB	1.100 (27.9) sq	0.600 (15.2)	27mm BGA	Black Anodized	0.031 (14.17)

Notes: 1. Optional factory preapplied pressure-sensitive adhesive. See Page 3

MECHANICAL DIMENSIONS



Dimensions: in. (mm)

KEY: ■ 658-25AB +658-35AB △ 658-45AB ○ 658-60AB

NATURAL AND FORCED CONVECTION CHARACTERISTICS

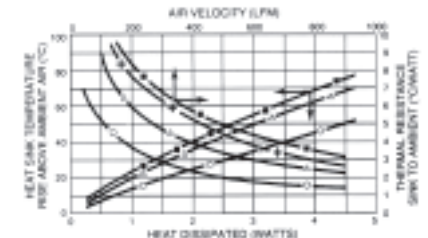

HEAT SINKS FOR BGAs, SUPER BGAs, PBGAs, and FPBGAs



660 SERIES Unidirectional Fin Heat Sink for BGAs

Standard P/N	Base Dimensions in. (mm)	Height in. (mm)	Typical Application	Heat Sink Finish	Weight lbs. (grams)
660-29AB	1.530SQ. (38.9)SQ.	0.285 (7.2)	37mm BGA	Black Anodized	0.031 (14.17)

Notes: 1. Optional factory preapplied pressure-sensitive adhesive. See Page 3

MECHANICAL DIMENSIONS



Dimensions: in. (mm)

NATURAL AND FORCED CONVECTION CHARACTERISTICS



642 SERIES Unidirectional Fin Heat Sink for BGAs

Standard P/N	Base Dimensions in. Sq.	Fin Height "A" in. (mm)	Typical Applications	Weight lbs. (grams)
642-25AB	1.378 (35)	.250 (6.4)	35 mm BGA	.022 (9.99)
642-35AB	1.378 (35)	.350 (8.9)	35 mm BGA	.027 (12.26)
642-45AB	1.378 (35)	.450 (11.4)	35 mm BGA	.031 (14.07)
642-60AB	1.378 (35)	.600 (15.2)	35 mm BGA	.039 (17.71)

Material: Aluminum, Black Anodized

The 642 Series is an unidirectional pin fin heat sink for both natural and forced-convection applications.

Applications include network routers and switches, high-resolution printers, digital cameras, consumer video games, digital video disks (DVD) and global positioning systems (GPS).

PRODUCT FEATURES

- Available in four standard heights, .25 inch, .35 inch, .45 inch, and .60 inch.
- Available with pressure sensitive adhesives for quick and easy mounting. See Page 3

MECHANICAL DIMENSIONS

642 SERIES



Dimensions: in. (mm)

642 THERMAL PERFORMANCE



Performance shown is with T4 thermal adhesive applied.

HEAT SINKS FOR BGAs, SUPER BGAs, PBGAs, and FPBGAs



662 SERIES Omnidirectional Pin Fin Heat Sink for Limited Height BGAs

Standard P/N	Base Dimensions in. (mm)	Height in. (mm)	Typical Applications	Heat Sink Finish	Weight lbs. (grams)
662-15AG	1.713 (43.5) sq	0.150 (3.8)	45mm BGA	Gold Iridite	0.019 (8.50)
662-15AB	1.713 (43.5) sq	0.150 (3.8)	45mm BGA	Black Anodized	0.019 (8.50)

Notes: 1. Optional factory preapplied pressure-sensitive adhesive. See Page 3

MECHANICAL DIMENSIONS

12 x 14 PINS



Dimensions: in. (mm)

NATURAL AND FORCED CONVECTION CHARACTERISTICS



628 SERIES Omnidirectional Pin Fin Heat Sink for BGAs

Standard P/N	Base Dimensions in. (mm)	Dimensions "A" in. (mm)	Typical Applications	Heat Sink Finish	Weight lbs. (grams)
628-20AB	1.750 (44.5) x 1.700 (43.2)	0.200 (5.1)	45mm BGA	Black Anodized	0.031 (14.17)
628-25AB	1.750 (44.5) x 1.700 (43.2)	0.250 (6.4)	45mm BGA	Black Anodized	0.038 (17.01)
628-35AB	1.750 (44.5) x 1.700 (43.2)	0.350 (8.9)	45mm BGA	Black Anodized	0.044 (19.84)
628-40AB	1.750 (44.5) x 1.700 (43.2)	0.400 (10.2)	45mm BGA	Black Anodized	0.050 (22.68)
628-65AB	1.750 (44.5) x 1.700 (43.2)	0.650 (16.5)	45mm BGA	Black Anodized	0.056 (25.51)

Notes: 1. Optional factory preapplied pressure-sensitive adhesive. See Page 3

MECHANICAL DIMENSIONS



11 x 10 PINS

Dimensions: in. (mm)

NATURAL CONVECTION CHARACTERISTICS



FORCED CONVECTION CHARACTERISTICS



KEY: △ 628-20AB ● 628-25AB ▲ 628-35AB ○ 628-40AB ■ 628-65AB

HEAT SINKS FOR BGAs, SUPER BGAs, PBGAs, and FPBGAs



630 SERIES Omnidirectional Pin Fin Heat Sink for BGAs

Standard P/N	Base Dimensions in. Sq.	Fin Height "A" in. (mm)	Typical Applications	Weight lbs. (grams)
630-25AB	1.378 (35)	.250 (6.4)	35mm BGA	.009 (4.09)
630-35AB	1.378 (35)	.350 (8.9)	35mm BGA	.011 (4.99)
630-45AB	1.378 (35)	.450 (11.4)	35mm BGA	.015 (6.81)
630-60AB	1.378 (35)	.600 (15.2)	35mm BGA	.026 (11.80)

Material: Aluminum, Black Anodized

The 630 Series is an omnidirectional pin fin heat sink for both natural and forced-convection applications.

Applications include network routers and switches, high-resolution printers, digital cameras, consumer video games, digital video disks (DVD) and global positioning systems (GPS).

PRODUCT FEATURES

- Available in four standard heights, .25 inch, .35 inch, .45 inch, and .60 inch.
- Available with pressure sensitive adhesives for quick and easy mounting. See Page 3

MECHANICAL DIMENSIONS

630 SERIES



Dimensions: in.

HEAT SINKS FOR BGAs, SUPER BGAs, PBGAs, and FPBGAs



698 SERIES Omnidirectional Pin Fin Heat Sink For BGAs

Standard P/N	Base Dimensions in. (mm)	Dimensions "A" in. (mm)	Typical Applications	Heat Sink Finish	Weight lbs. (grams)
698-40AB	2.100 (53.3) sq.	0.400 (10.2) sq.	45mm BGA	Black Anodized	0.075 (34.02)
698-65AB	2.100 (53.3) sq.	0.650 (16.5) sq.	45mm BGA	Black Anodized	0.119 (53.86)
698-80AB	2.100 (53.3) sq.	0.800 (20.3) sq.	45mm BGA	Black Anodized	0.125 (56.70)
698-100AB	2.100 (53.3) sq.	1.000 (25.4) sq.	45mm BGA	Black Anodized	0.144 (65.20)

Notes: 1. Optional factory preapplied pressure-sensitive adhesive. See Page 3

MECHANICAL DIMENSIONS



Dimensions: in. (mm)

FORCED CONVECTION THERMAL PERFORMANCE DATA (FLOW PARALLEL TO EXTRUSION DIRECTION)



KEY: □ 698-40AB ▲ 698-65AB ○ 698-80AB ■ 698-100AB

HEAT SINKS FOR BGAs, SUPER BGAs, PBGAs, and FPBGAs



798 SERIES Pin Fin Heat Sink for BGAs

Standard P/N	Base Dimensions in. (mm)	Dimensions "A" in. (mm)	Typical Applications	Heat Sink Finish	Weight lbs. (grams)
798-40AB	2.100 (53.3) x 1.860 (47.2)	0.400 (10.2)	45mm BGA	Black Anodized	0.063 (28.35)
798-65AB	2.100 (53.3) x 1.860 (47.2)	0.650 (16.5)	45mm BGA	Black Anodized	0.106 (48.19)
798-80AB	2.100 (53.3) x 1.860 (47.2)	0.800 (20.3)	45mm BGA	Black Anodized	0.113 (51.03)
798-100AB	2.100 (53.3) x 1.860 (47.2)	1.000 (25.4)	45mm BGA	Black Anodized	0.131 (59.53)

MECHANICAL DIMENSIONS



Dimensions: in. (mm)

FORCED CONVECTION THERMAL PERFORMANCE DATA (FLOW PARALLEL TO EXTRUSION DIRECTION)



KEY: □ 798-40AB ▲ 798-65AB ○ 798-80AB ■ 798-100AB

Notes:

- Heat sink mounting surface flatness: 0.004" TIR
- Optional factory preapplied pressure-sensitive adhesive. See Page 3



643 SERIES Omnidirectional Pin Fin Heat Sink for BGAs

Standard P/N	Base Dimensions in. (mm)	Fin Height in. (mm)	Typical Applications	Weight lbs. (grams)
643-35AP	1.60 (40.64) x 1.10 (27.94)	0.350 (8.89)	40 mm BGA	.070 (31.78)

Material: Aluminum, Plain Finish

The Series 643-35AP is an omnidirectional pin fin heat sink for both natural and forced-convection applications designed to fit a 40 mm BGA.

Applications include network routers and switches, high-resolution printers, digital cameras, consumer video games, digital video disks (DVD) and global positioning systems (GPS).

PRODUCT FEATURES

- Available with pressure sensitive adhesives to ensure good thermal performance. See page 3
- Can be ordered with the 829SC clip. Order clip separately. (Clip cannot be purchased without heat sink)

MECHANICAL DIMENSIONS



Dimensions: in.

643-35AP SERIES

643 THERMAL PERFORMANCE



Performance shown is with S5 interface material applied.

DELTEM™ COMPOSITE HEAT SINKS FOR BGAs



Deltem™ D10650-40 Pin Fin Heat Sink

Standard P/N	Base Dimensions in. (mm)	Height in. (mm)	Weight lbs. (grams)
D10650-40	0.650 (16.5) sq	0.400 (10.2)	0.004 (1.91)

Notes: Available with pressure sensitive adhesives for quick and easy mounting. See Page 3



Deltem™ D10850-40 Pin Fin Heat Sink

Standard P/N	Base Dimensions in. (mm)	Height in. (mm)	Typical Applications	Weight lbs. (grams)
D10850-40	0.850 (21.6) sq	0.400 (10.2)	21mm BGA	0.006 (3.9)

Notes: Available with pressure sensitive adhesives for quick and easy mounting. See Page 3

MECHANICAL DIMENSIONS

DELTEM™ D10650-40 PIN FIN HEAT SINK



NATURAL AND FORCED CONVECTION CHARACTERISTICS



Dimensions: in. (mm)

DELTEM™ D10850-40 PIN FIN HEAT SINK



NATURAL AND FORCED CONVECTION CHARACTERISTICS



HEAT SINKS FOR BGAs, SUPER BGAs, PBGAs, and FPBGAs



609 SERIES Pin Fin Heat Sink/Clip Assembly for BGAs and PowerPC™ Packages

Standard P/N	Base Dimensions in. (mm)	Dimensions "A" in. (mm)	Typical Applications	Heat Sink Finish	Weight lbs. (grams)
609-50AB	2.895 (73.5) x 2.000 (50.8)	0.500 (12.7)	40&45mm BGA	Black Anodized	0.094 (42.5)
609-100AB	2.808 (71.32) x 1.700 (43.2)	1.00 (25.4)	40&45mm BGA	Black Anodized	0.130 (59.0)

Note: Optional factory preapplied thermal interface material.
 S3 (Bergquist Q-Pad 3, 0.14 °C in²/w)
 S4 (Bergquist Softface, 0.07 °C in²/w)

MECHANICAL DIMENSIONS



FORCED CONVECTION THERMAL PERFORMANCE DATA (FLOW PARALLEL TO EXTRUSION DIRECTION)



*Performance is for shrouded conditions. 609-100 will perform better than 609-50 in cases with bypass.



619 SERIES Fan Heat Sink for BGA and PowerPC™ Packages

Standard P/N	Base Dimensions in. (mm)	Height in. (mm)	Typical Applications	Heat Sink Finish	Thermal Performance	Weight lbs. (grams)
61995AB124D1	2.871 (72.92) x 1.98 (50.29)	0.953 (24.21)	40&45mm BGA	Black Anodized	1.2° C/W	.150 (68.10)
61995AB054D1	2.871 (72.92) x 1.98 (50.29)	0.953 (24.21)	40&45mm BGA	Black Anodized	1.2° C/W	.150 (68.10)

Note: Optional factory preapplied thermal interface material. See 609 series.

FEATURES AND BENEFITS:

- Captivated clips for ease of assembly
- Low acoustic noise
- Impingement air flow
- Accommodates BGA packages up to 45 mm in size

MECHANICAL DIMENSIONS



See 609 Series for PCB hole layout for clip attachment

HEAT SINKS FOR BGAs, SUPER BGAs, PBGAs, and FPBGAs



602 SERIES *Unidirectional Fin Heat Sink for BGAs*

Standard P/N	Base Dimensions in. (mm)	Height in. (mm)	Heat Sink Finish	Weight lbs. (grams)
602-100AP	.750 (19.1) sq	1.000 (25.4)	Plain	.021 (9.59)

Material: Aluminum, Plain Finish

MECHANICAL DIMENSIONS

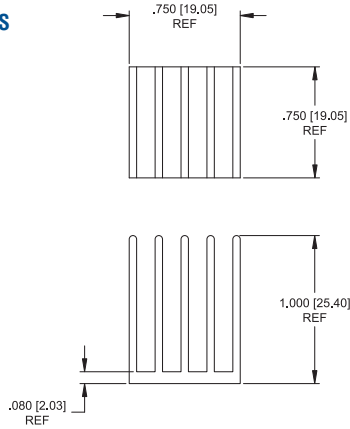

602 THERMAL PERFORMANCE



604 SERIES *Omnidirectional Pin Fin Heat Sink for BGAs*

Standard P/N	Base Dimensions in. (mm)	Height in. (mm)	Heat Sink Finish	Weight lbs. (grams)
604-40AB	.850 (21.6) sq	.400 (10.2)	Black Anodized	.012 (5.60)
604-60AB	.850 (21.6) sq	.600 (15.2)	Black Anodized	.016 (7.47)

Material: Aluminum, Black Anodized

MECHANICAL DIMENSIONS



604 THERMAL PERFORMANCE



HEAT SINKS FOR BGAs, SUPER BGAs, PBGAs, and FPBGAs



605 SERIES

Unidirectional Fin Heat Sink for BGAs

Standard P/N	Base Dimensions in. (mm)	Height in. (mm)	Heat Sink Finish	Weight lbs. (grams)
605-75AB	.880 (22.4) sq	.750 (19.1)	Black Anodized	.030 (13.5)

Material: Aluminum, Black Anodized

MECHANICAL DIMENSIONS

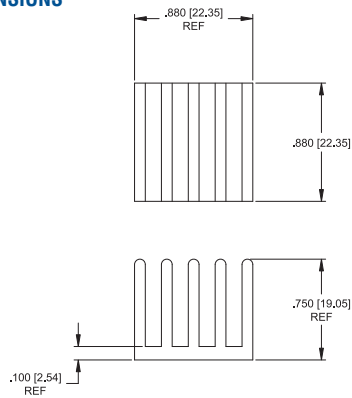

605 THERMAL PERFORMANCE



606 SERIES

Unidirectional Fin Heat Sink for BGAs

Standard P/N	Base Dimensions in. (mm)	Height in. (mm)	Heat Sink Finish	Weight lbs. (grams)
606-77AB	1.185 (30.1) sq	.767 (19.5)	Black Anodized	.041 (18.7)

Material: Aluminum, Black Anodized

MECHANICAL DIMENSIONS



606 THERMAL PERFORMANCE



HEAT SINKS FOR BGAs, SUPER BGAs, PBGAs, and FPBGAs



607 SERIES

Unidirectional Fin Heat Sink for BGAs

Standard P/N	Base Dimensions in. (mm)	Height in. (mm)	Heat Sink Finish	Weight lbs. (grams)
607-65AB	1.200 (30.5) x 1.105 (28.1)	.650 (16.5)	Black Anodized	.041 (18.7)

Material: Aluminum, Black Anodized

MECHANICAL DIMENSIONS



607 THERMAL PERFORMANCE



610 SERIES

Omnidirectional Pin Fin Heat Sink for BGAs

Standard P/N	Base Dimensions in. (mm)	Height in. (mm)	Heat Sink Finish	Weight lbs. (grams)
610-35AB	1.240 (31.5) sq	.350 (8.9)	Black Anodized	.022 (10.0)
610-40AB	1.240 (31.5) sq	.400 (10.2)	Black Anodized	.024 (10.8)

Material: Aluminum, Black Anodized

MECHANICAL DIMENSIONS



610 THERMAL PERFORMANCE



HEAT SINKS FOR BGAs, SUPER BGAs, PBGAs, and FPBGAs



611 SERIES

Unidirectional Fin Heat Sink for BGAs

Standard P/N	Base Dimensions in. (mm)	Height in. (mm)	Heat Sink Finish	Weight lbs. (grams)
611-80AB	1.200 (30.5) sq	.800 (20.3)	Black Anodized	.036 (16.3)

Material: Aluminum, Black Anodized

MECHANICAL DIMENSIONS



611 THERMAL PERFORMANCE



612 SERIES

Unidirectional Fin Heat Sink for BGAs

Standard P/N	Base Dimensions in. (mm)	Height in. (mm)	Heat Sink Finish	Weight lbs. (grams)
612-65AB	1.390 (35.3) sq	.650 (16.5)	Black Anodized	.054 (24.5)

Material: Aluminum, Black Anodized

MECHANICAL DIMENSIONS



612 THERMAL PERFORMANCE



HEAT SINKS FOR BGAs, SUPER BGAs, PBGAs, and FPBGAs



613 SERIES Unidirectional Fin Heat Sink for BGAs

Standard P/N	Base Dimensions in. (mm)	Height in. (mm)	Heat Sink Finish	Weight lbs. (grams)
613-50AB	1.450 (36.8) sq	.500 (12.7)	Black Anodized	.046 (20.8)

Material: Aluminum, Black Anodized

MECHANICAL DIMENSIONS



613 THERMAL PERFORMANCE

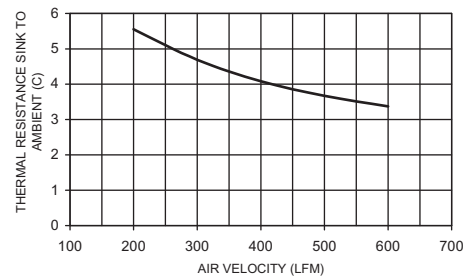

614 SERIES Unidirectional Fin Heat Sink for BGAs

Standard P/N	Base Dimensions in. (mm)	Height in. (mm)	Heat Sink Finish	Weight lbs. (grams)
614-30AB	1.500 (38.1) sq	.300 (7.6)	Black Anodized	.030 (13.8)
614-50AB	1.500 (38.1) sq	.500 (12.7)	Black Anodized	.048 (21.8)
614-100AP	1.500 (38.1) sq	1.000 (25.4)	Plain	.046 (20.9)

Material: Aluminum, Black Anodized or Plain

MECHANICAL DIMENSIONS



614 THERMAL PERFORMANCE

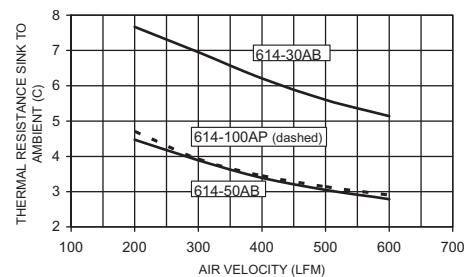

HEAT SINKS FOR BGAs, SUPER BGAs, PBGAs, and FPBGAs



615 SERIES Unidirectional Fin Heat Sink for BGAs

Standard P/N	Base Dimensions in. (mm)	Height in. (mm)	Heat Sink Finish	Weight lbs. (grams)
615-41AB	1.600 (40.6) sq	.410 (10.4)	Black Anodized	.046 (21.0)

Material: Aluminum, Black Anodized



616 SERIES Unidirectional Fin Heat Sink for BGAs

Standard P/N	Base Dimensions in. (mm)	Height in. (mm)	Heat Sink Finish	Weight lbs. (grams)
616-80AB	1.85 (47.0) sq	.800 (20.3)	Black Anodized	.054 (24.5)

Material: Aluminum, Black Anodized



HEAT SINKS FOR BGAs, SUPER BGAs, PBGAs, and FPBGAs



617 SERIES Unidirectional Fin Heat Sink for BGAs

Standard P/N	Base Dimensions in. (mm)	Height in. (mm)	Heat Sink Finish	Weight lbs. (grams)
617-80AB	1.450 (36.8) x 1.850 (47.0)	.800 (20.3)	Black Anodized	.082 (37.2)

Material: Aluminum, Black Anodized

MECHANICAL DIMENSIONS



617 THERMAL PERFORMANCE



618 SERIES Unidirectional Fin Heat Sink for BGAs

Standard P/N	Base Dimensions in. (mm)	Height in. (mm)	Heat Sink Finish	Weight lbs. (grams)
618-20AB	2.00 (50.8) sq	.200 (5.1)	Black Anodized	.046 (21.0)
618-100AP	2.00 (80.8) sq	1.000 (25.4)	Plain	.122 (55.5)

Material: Aluminum, Black Anodized or Plain

MECHANICAL DIMENSIONS



618 THERMAL PERFORMANCE



HEAT SINKS FOR BGAs, SUPER BGAs, PBGAs, and FPBGAs



620 SERIES Unidirectional Fin Heat Sink for BGAs

Standard P/N	Base Dimensions in. (mm)	Height in. (mm)	Heat Sink Finish	Weight lbs. (grams)
620-24AB	2.500 (63.5) x 2.000 (50.8)	.235 (6.0)	Black Anodized	.063 (28.6)

Material: Aluminum, Black Anodized



622 SERIES Unidirectional Fin Heat Sink for BGAs

Standard P/N	Base Dimensions in. (mm)	Height in. (mm)	Heat Sink Finish	Weight lbs. (grams)
622-80AB	2.050 (52.1) x 2.000 (50.8)	.800 (20.3)	Black Anodized	.123 (56.0)

Material: Aluminum, Black Anodized



HEAT SINKS FOR MICROPROCESSORS AND ASICs

569, 579, 589, 599 SERIES

Heat Sinks & Clip for Intel's Pentium, Pentium MMX, AMD's K6 & K62, CYRIX's 6x86 & Media GX, Centaur/IDT's WinChip C6

Standard P/N	Base Dimensions in. (mm)	Fin Height in. (mm)	Thermal Resistance at 200 LFM (°C/W)	Interface Material Options
569-100AK	2.34 (59.44) x 2.68 (67.95)	1.00 (25.4)	1.7	Pages 74-76
579-150AK	2.15 (54.71) x 1.95 (49.53)	1.50 (38.10)	1.6	Pages 74-76
589-150AK	2.15 (54.71) x 3.10 (78.74)	1.50 (38.10)	1.5	Pages 74-76
599X-100AB	1.96 (49.78) x 2.67 (67.95)	1.00 (25.4)	1.9	Pages 74-76

Material: Aluminum, Black Anodized

PRODUCT FEATURES

- Compact design heat sinks can comfortably fit a variety of Robust Socket 7-based PC boxes
- Robust clip attachments

- Clips are not captive to sink
- To order heat sink with optional interface material pre-applied at the factory, add S4 or S5 suffix to the part number. (See Product Designation)

569-100AK SERIES

Dimensions: in.

MECHANICAL DIMENSIONS

OPTIONAL THERMAL INTERFACE PAD (SEE PRODUCT DES.)

SPRING CLIP OPTION (SEE PRODUCT DES.)

PRODUCT DESIGNATION

569 - 100 XX - XX

MODEL NUMBER	THERMAL INTERFACE
HEIGHT	S4 = DELTALINK IV BLANK = NO THERMAL PAD
100 = 1.00"	CLIP
	AK = SPRING CLIP



650/651 SERIES

Low-Cost Heat Sinks for DIPs and SRAMs

14-16 Pin DIPs

Standard P/N	Length in. (mm)	Width in. (mm)	Height in. (mm)	Typical Applications	Weight lbs. (grams)
650B	0.250 (6.4)	0.740 (18.9)	0.240 (6.1)	14-Pin, 16-Pin DIP	0.003 (1.36)
651B	0.750 (19.1)	0.415 (10.5)	0.240 (6.1)	14-Pin, 16-Pin DIP	0.005 (2.27)

These extruded heat sinks serve as low-cost heat dissipation solutions for DIPs with pin counts from 14 to 16. Use an epoxy such as Wakefield Engineering DeltaBond™ 152 or 155, or use Wakefield 2-part DeltaBond™ 156 modified

acrylic adhesive. The 650 and 651 are also available in natural aluminum finish. They can be ordered as 650P or 651P.

MECHANICAL DIMENSIONS

Notes:

1. Finish: black anodize
2. TIR: Total Indicator Reading. This is a measure of flatness across the greatest dimension of a surface.

650B **651B**

Dimensions: in. (mm)

NATURAL AND FORCED CONVECTION CHARACTERISTICS

Graph showing Thermal Resistance (°C/W) vs. Heat Dissipated (Watts) for 650B and 651B heat sinks. The graph includes curves for Natural Convection and Forced Convection (Air Velocity 100, 200, 300, 400, 500 LFM).

HEAT SINKS FOR MICROPROCESSORS AND ASICs



649 SERIES SpiderClip™ Heat Sink Assembly for Motorola MC68040™, MC68060

18 x 18 PGA

Standard P/N	Base Dimensions in. (mm)	Height in. (mm)	Base Thickness in. (mm)	Clip Color	Heat Sink Finish	Weight lbs. (grams)
649-33AB	1.70 (43.2) sq	0.315 (8.0)	0.090 (2.3)	Gray	Black Anodized	0.044 (19.84)
649-51AB	1.86 (47.2) sq	0.510 (13.0)	0.090 (2.3)	Gray	Black Anodized	0.056 (25.51)

MECHANICAL DIMENSIONS



649-33AB SPIDERCLIP™ ASSEMBLY

649-51AB SPIDERCLIP™ ASSEMBLY

Dimensions: in. (mm)

NATURAL AND FORCED CONVECTION CHARACTERISTICS

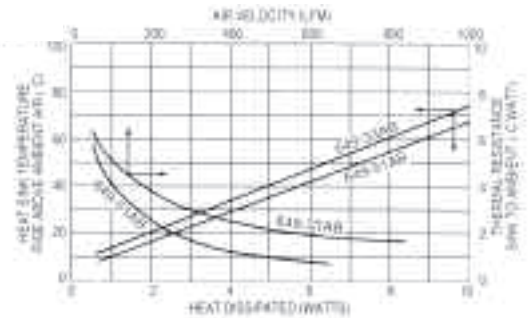

669 SERIES SpiderClip™ Heat Sink Assembly for IntelDX4™, AMD AM486DX2, and AM486DX4
661 SERIES Heat Sink without clip

17 x 17 SPGA

Standard P/N	Base Dimensions in. (mm)	Dimensions "A" Height in. (mm)	Base Thickness in. (mm)	Clip Color	Standard Finish	Weight lbs. (grams)
669-32AG	1.70 (43.2) sq	0.315 (8.0)	0.090 (2.3)	Black	Gold Iridite	0.044 (19.84)
669-33AB	1.70 (43.2) sq	0.315 (8.0)	0.090 (2.3)	Black	Black Anodized	0.044 (19.84)
669-40AB	1.70 (43.2) sq	0.400 (10.2)	0.090 (2.3)	Black	Black Anodized	0.044 (19.84)
669-52AB	1.70 (43.2) sq	0.520 (13.2)	0.090 (2.3)	Black	Black Anodized	0.050 (22.68)
661-32AG	1.70 (43.2) sq	0.315 (8.0)	0.090 (2.3)	N/A	Gold Iridite	0.044 (19.84)
661-33AB	1.70 (43.2) sq	0.315 (8.0)	0.090 (2.3)	N/A	Black Anodized	0.044 (19.84)
661-40AB	1.70 (43.2) sq	0.400 (10.2)	0.090 (2.3)	N/A	Black Anodized	0.044 (19.84)
661-52AB	1.70 (43.2) sq	0.520 (13.2)	0.090 (2.3)	N/A	Black Anodized	0.050 (22.68)

669 Series SpiderClip™ Heat Sink Assemblies may be applied to the following:

- Intel 80486DX and 80486DX2™ (168 PGA)
- Intel 82495 Cache Controller
- Intel 80486SX (168 PGA) and I860XR (208 PGA)
- Intel I960CA, I960CF Embedded Controllers
- Intel DX4™ (168 PGA)
- AMD Am 486 Microprocessors AM486DX2, AM486DX4

MECHANICAL DIMENSIONS



669-32AG 10 x 10 PIN MATRIX

669-33AB
669-40AB
669-52AB 12 x 12 PIN MATRIX



669-32AG SPIDERCLIP™ ASSEMBLY



669-52AB SPIDERCLIP™ ASSEMBLY



NATURAL AND FORCED CONVECTION CHARACTERISTICS



Dielectric Breakdown (Nylon Clip Coating)

Dimensions: in. (mm)

Dielectric Strength: 100 VDC/mil
Breakdown Voltage: 200 VDC (minimum)

KEY:

- 669-32AG 0.315 (8.0) Pin Height, low density pin pattern
- ▲ 669-33AB 0.315 (8.0) Pin Height, high density pin pattern
- ◆ 669-40AB 0.400 (10.2) Pin Height, high density pin pattern
- 669-52AB 0.520 (13.2) Pin Height, high density pin pattern



Компания «ЭлектроПласт» предлагает заключение долгосрочных отношений при поставках импортных электронных компонентов на взаимовыгодных условиях!

Наши преимущества:

- Оперативные поставки широкого спектра электронных компонентов отечественного и импортного производства напрямую от производителей и с крупнейших мировых складов;
- Поставка более 17-ти миллионов наименований электронных компонентов;
- Поставка сложных, дефицитных, либо снятых с производства позиций;
- Оперативные сроки поставки под заказ (от 5 рабочих дней);
- Экспресс доставка в любую точку России;
- Техническая поддержка проекта, помощь в подборе аналогов, поставка прототипов;
- Система менеджмента качества сертифицирована по Международному стандарту ISO 9001;
- Лицензия ФСБ на осуществление работ с использованием сведений, составляющих государственную тайну;
- Поставка специализированных компонентов (Xilinx, Altera, Analog Devices, Intersil, Interpoint, Microsemi, Aeroflex, Peregrine, Syfer, Eurofarad, Texas Instrument, Miteq, Cobham, E2V, MA-COM, Hittite, Mini-Circuits, General Dynamics и др.);

Помимо этого, одним из направлений компании «ЭлектроПласт» является направление «Источники питания». Мы предлагаем Вам помощь Конструкторского отдела:

- Подбор оптимального решения, техническое обоснование при выборе компонента;
- Подбор аналогов;
- Консультации по применению компонента;
- Поставка образцов и прототипов;
- Техническая поддержка проекта;
- Защита от снятия компонента с производства.



Как с нами связаться

Телефон: 8 (812) 309 58 32 (многоканальный)

Факс: 8 (812) 320-02-42

Электронная почта: org@eplast1.ru

Адрес: 198099, г. Санкт-Петербург, ул. Калинина, дом 2, корпус 4, литера А.