



# 60×60×15 mm

**San Ace 60 9GA type** Low Power Consumption Fan

## General Specifications

- Material ..... Frame: Plastic (Flammability: UL 94V-0), Impeller: Plastic (Flammability: UL 94V-0)
- Expected life ..... See the table below. (L10 life: 90% survival rate for continuous operation in free air at 60°C, rated voltage)
- Motor protection function ..... Locked rotor burnout protection, Reverse polarity protection  
For details, please refer to p. 547.
- Dielectric strength ..... 50/60 Hz, 500 VAC, for 1 minute (between lead wire conductors and frame)
- Insulation resistance ..... 10 MΩ or more with a 500 VDC megger (between lead wire conductors and frame)
- Sound pressure level (SPL) ..... At 1 m away from the air inlet
- Storage temperature ..... -30 to +70°C (Non-condensing)
- Lead wire ..... ⊕Red ⊖Black (Sensor) Yellow (Control) Brown  
(For models without PWM control function, there is no speed control wiring.)
- Mass ..... 50 g

## Specifications

The models listed below **have ribs and pulse sensors with PWM control function.**

Model no.	Rated voltage [V]	Operating voltage range [V]	PWM duty cycle* [%]	Rated current [A]	Rated input [W]	Rated speed [min <sup>-1</sup> ]	Max. airflow [m <sup>3</sup> /min] [CFM]	Max. static pressure [Pa] [inchH <sub>2</sub> O]	SPL [dB (A)]	Operating temperature [°C]	Expected life [h]
9GA0612P7G01	12	10.2 to 13.8	100	0.16	1.92	5900	0.68 24	80 0.32	38	-20 to +70	40000/60°C (70000/40°C)
			0	0.05	0.6	1500	0.17 6.0	5.2 0.02	10		
9GA0612P7H01	12	10.2 to 13.8	100	0.1	1.2	4900	0.56 19.7	55.6 0.223	34		
			0	0.03	0.36	1300	0.15 5.3	3.9 0.015	8		
9GA0624P7G01**	24	20.4 to 27.6	100	0.08	1.92	5900	0.68 24.0	80 0.32	38		

\* PWM frequency: 25 kHz \*\* Fan does not rotate when PWM duty cycle is 0%.

The following sensor and control options are available for selection.

Available for all models. **Without sensor**

Differs according to the model. Refer to the table on p. 571. **Pulse sensor** **Lock sensor**

The models listed below **have ribs and pulse sensors.**

Model no.	Rated voltage [V]	Operating voltage range [V]	Rated current [A]	Rated input [W]	Rated speed [min <sup>-1</sup> ]	Max. airflow [m <sup>3</sup> /min] [CFM]	Max. static pressure [Pa] [inchH <sub>2</sub> O]	SPL [dB (A)]	Operating temperature [°C]	Expected life [h]
9GA0612G701	12	6 to 13.8	0.16	1.92	5900	0.68 24	80 0.32	38	-20 to +70	40000/60°C (70000/40°C)
9GA0612H701			0.1	1.2	4900	0.56 19.7	55.6 0.223	34		
9GA0612M701			0.08	0.96	3900	0.45 15.9	35.3 0.142	28		
9GA0612L701			0.03	0.36	2800	0.31 10.9	18 0.072	17		
9GA0624M701	24	12 to 27.6	0.05	1.2	3900	0.45 15.9	35.3 0.142	28		40000/60°C (70000/40°C)

The following sensor and control options are available for selection.

Available for all models. **Without sensor**

Differs according to the model. Refer to the table on pp. 570 to 571. **Lock sensor** **PWM control**

## Airflow - Static Pressure Characteristics / PWM Duty - Speed Characteristics Example

**9GA0612P7G01** With pulse sensor with PWM control function

PWM duty cycle

Operating voltage range

PWM duty - Speed characteristics example

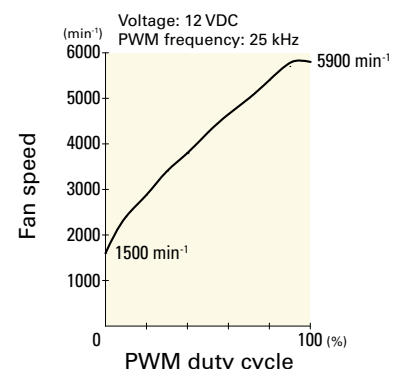
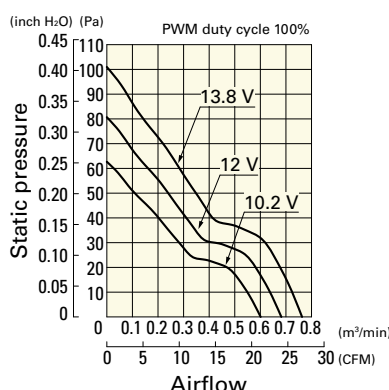
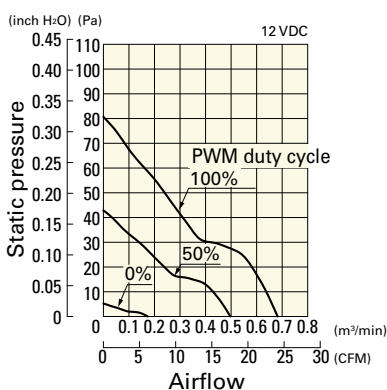

# Airflow - Static Pressure Characteristics / PWM Duty - Speed Characteristics Example

**9GA0612P7H01** With pulse sensor with PWM control function

PWM duty cycle

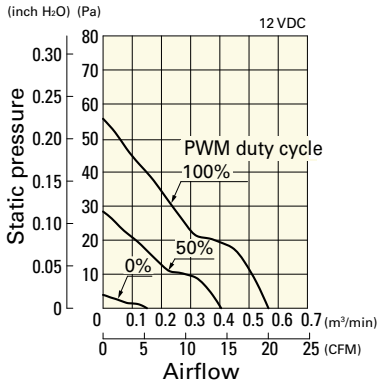

Operating voltage range

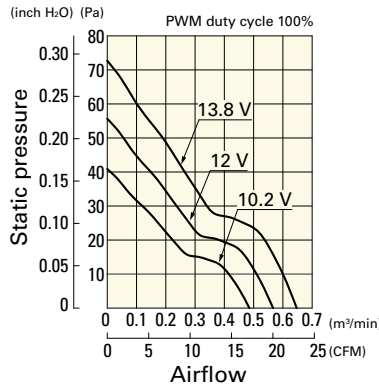

PWM duty - Speed characteristics example

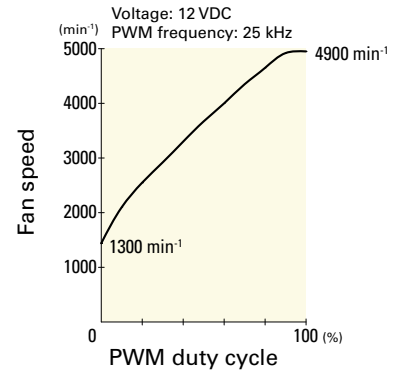

**9GA0624P7G01** With pulse sensor with PWM control function

PWM duty cycle

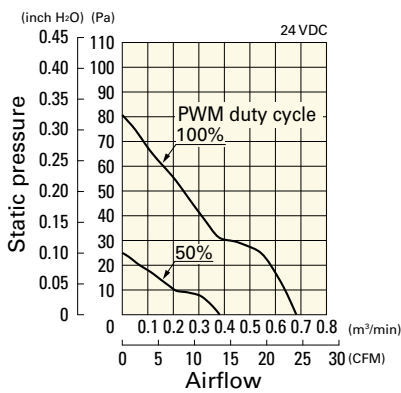

Operating voltage range

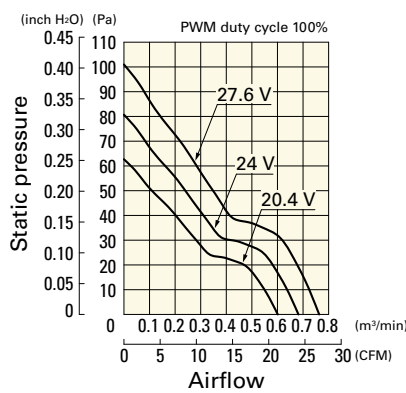

PWM duty - Speed characteristics example

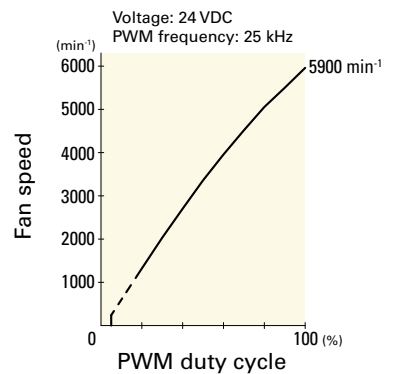

**9GA0612G701** With pulse sensor

Operating voltage range

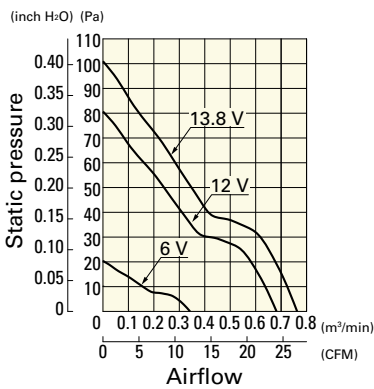

**9GA0612H701** With pulse sensor

Operating voltage range

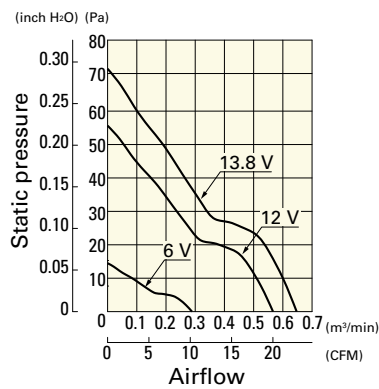

**9GA0612M701** With pulse sensor

Operating voltage range

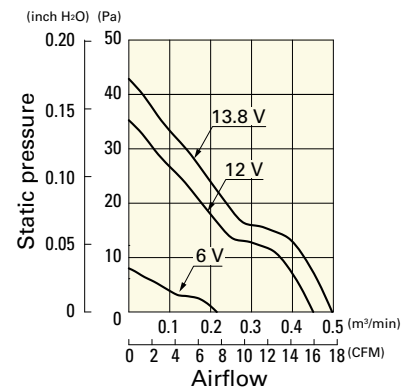

**9GA0612L701** With pulse sensor

Operating voltage range

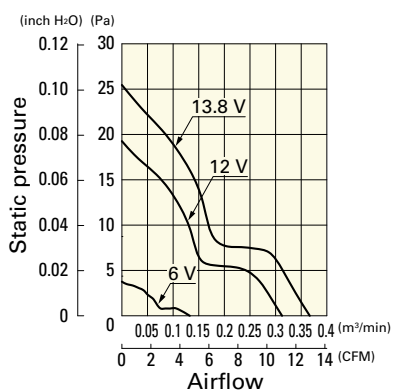

**9GA0624M701** With pulse sensor

Operating voltage range

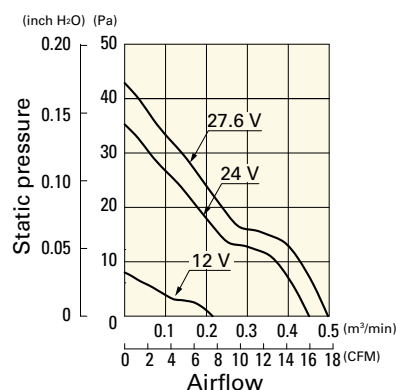

**Dimensions (unit: mm)** (With pulse sensor with PWM control function)

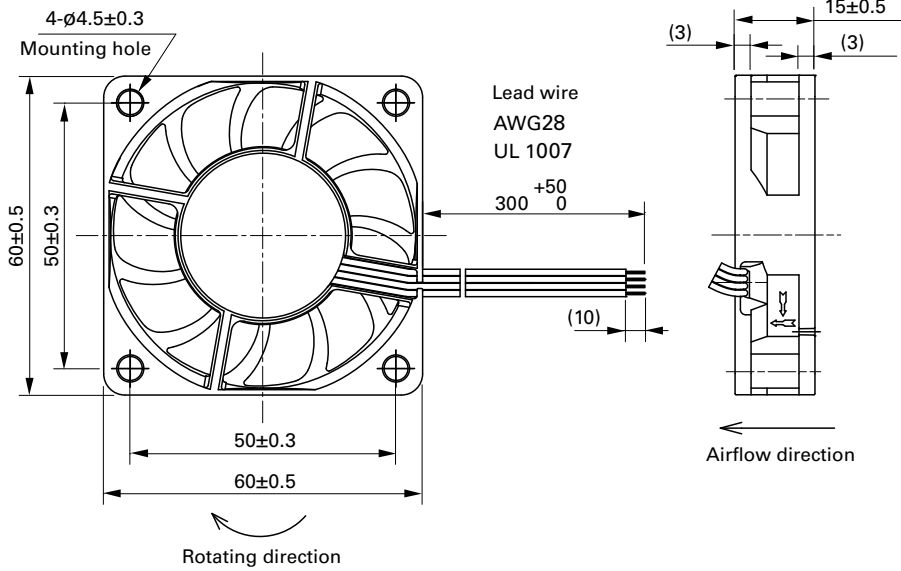

**Reference Dimensions of Mounting Holes and Vent Opening (unit: mm)**

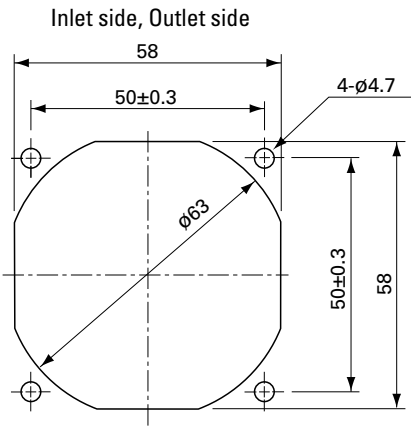

**Options**

**Finger guards**

page: p. 532

Model no.: 109-139E, 109-139H

**Resin finger guards**

page: p. 539

Model no.: 109-1003G

**Resin filter kits**

page: p. 540

Model no.: 109-1003F13 (13PPI), 109-1003F20 (20PPI),  
109-1003F30 (30PPI), 109-1003F40 (40PPI)



Компания «ЭлектроПласт» предлагает заключение долгосрочных отношений при поставках импортных электронных компонентов на взаимовыгодных условиях!

Наши преимущества:

- Оперативные поставки широкого спектра электронных компонентов отечественного и импортного производства напрямую от производителей и с крупнейших мировых складов;
- Поставка более 17-ти миллионов наименований электронных компонентов;
- Поставка сложных, дефицитных, либо снятых с производства позиций;
- Оперативные сроки поставки под заказ (от 5 рабочих дней);
- Экспресс доставка в любую точку России;
- Техническая поддержка проекта, помощь в подборе аналогов, поставка прототипов;
- Система менеджмента качества сертифицирована по Международному стандарту ISO 9001;
- Лицензия ФСБ на осуществление работ с использованием сведений, составляющих государственную тайну;
- Поставка специализированных компонентов (Xilinx, Altera, Analog Devices, Intersil, Interpoint, Microsemi, Aeroflex, Peregrine, Syfer, Eurofarad, Texas Instrument, Miteq, Cobham, E2V, MA-COM, Hittite, Mini-Circuits, General Dynamics и др.);

Помимо этого, одним из направлений компании «ЭлектроПласт» является направление «Источники питания». Мы предлагаем Вам помощь Конструкторского отдела:

- Подбор оптимального решения, техническое обоснование при выборе компонента;
- Подбор аналогов;
- Консультации по применению компонента;
- Поставка образцов и прототипов;
- Техническая поддержка проекта;
- Защита от снятия компонента с производства.



#### Как с нами связаться

**Телефон:** 8 (812) 309 58 32 (многоканальный)

**Факс:** 8 (812) 320-02-42

**Электронная почта:** [org@eplast1.ru](mailto:org@eplast1.ru)

**Адрес:** 198099, г. Санкт-Петербург, ул. Калинина, дом 2, корпус 4, литера А.