

# SERIES 100 SWITCHES

## TOGGLE SWITCHES - MINIATURE



### SPECIFICATIONS

Contact Rating:	See contact material options
Life Expectancy:	40,000 make-and-break cycles
Contact Resistance:	10 mΩ max. typical initial @ 2-4 VDC 100 mA for both silver and gold plated contacts
Insulation Resistance:	1,000 MΩ min.
Dielectric Strength:	1,000 V RMS @ sea level
Operating Temperature:	-30° C to 85° C

### MATERIALS

Case:	Diallyl Phthalate (DAP)
Toggle Handle:	Brass, chrome plated
Switch Support:	Brass or steel, tin plated
Bushing:	Brass, nickel plated
Housing:	Stainless steel
Contacts / Terminals:	Silver or gold plated copper alloy

### FEATURES & BENEFITS

- ▶ Up to 4 poles available
- ▶ Variety of switching functions
- ▶ Miniature
- ▶ Multiple actuator & bushing options

### APPLICATIONS/MARKETS

- ▶ Telecommunications
- ▶ Instrumentation
- ▶ Networking
- ▶ Medical equipment

### HOW TO ORDER

SERIES	MODEL NO.	ACTUATOR	BUSHING	TERMINATION	CONTACT MATERIAL	SEAL	HARDWARE
100	□ □ □	□ □	□ □ □	□ □ □ □	□	E	□
	SP1 SP2* SP3 SP4* SP5* DP1 DP2* DP3 DP4* DP5* DP6 DP7* DP8* 3P1 3P2* 3P3 3P4* 3P5* 4P1 4P2* 4P3 4P4* 4P5* 4P6 4P7* 4P8*	T1† T2 T3 T4 T5 T6 T7 T8 T9 K1 K2  † Optional Toggle Cap (T1 Only): T100-1 = White T100-2 = Black	B1 B2 B3 B4 B5 B6 B8 B9 B11 B12 B13 B15 B16 B25** B26**	M1 M2 M3 M5 M6 M61 M7 M71 VS2 VS3 VS5* M64* VS21* VS31*	Q = Silver R = Gold	E = Epoxy Sealed at Base of Terminal	H = Hardware

▶ ▶ ▶ Example Ordering Number  
100-SP1-T4-B2-M1-R-E

Notes: \* Not available with the K1 and K2 actuator options.

\*\* Available only with the K1 and K2 actuator options.

Specifications subject to change without notice.



### SPDT



SCHEMATIC

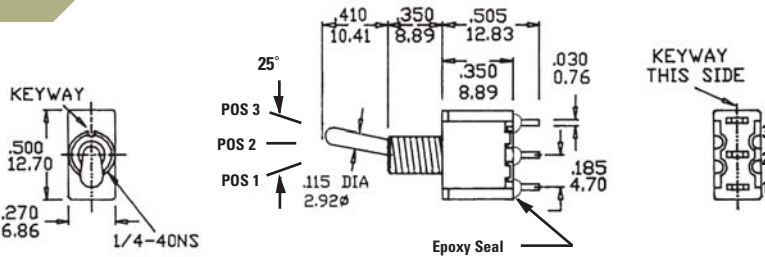

Model No.	POS 1	POS 2	POS 3
SP-1	ON	NONE	ON
SP-2	ON	NONE	(ON)
SP-3	ON	OFF	ON
SP-4	(ON)	OFF	(ON)
SP-5	ON	OFF	(ON)
Term. Comm.	2-3	OPEN	2-1

( ) = Momentary

### DPDT

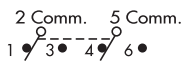

SCHEMATIC

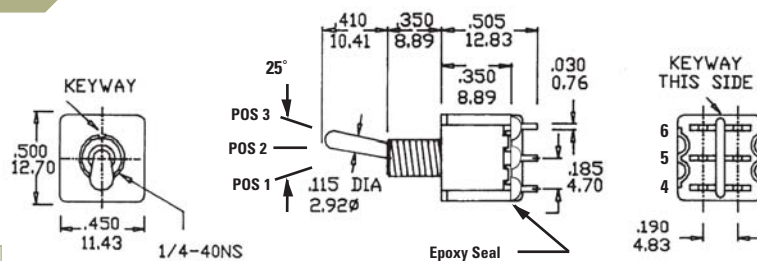

Model No.	POS 1	POS 2	POS 3
DP-1	ON	NONE	ON
DP-2	ON	NONE	(ON)
DP-3	ON	OFF	ON
DP-4	(ON)	OFF	(ON)
DP-5	ON	OFF	(ON)
DP-7	ON	ON	(ON)
DP-8	(ON)	ON	(ON)
Term. Comm.	2-3, 5-6	OPEN	2-1, 5-4

DP-6	ON	ON	ON
Term. Comm.	2-3, 5-6	2-3, 5-4	2-1, 5-4

( ) = Momentary

### 3PDT



SCHEMATIC

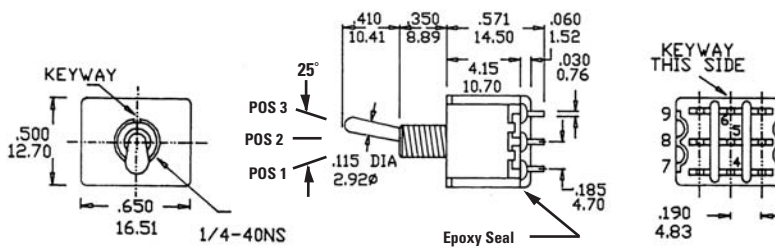

Model No.	POS 1	POS 2	POS 3
3P-1	ON	NONE	ON
3P-2	ON	NONE	(ON)
3P-3	ON	OFF	ON
3P-4	(ON)	OFF	(ON)
3P-5	ON	OFF	(ON)
Term. Comm.	2-3, 5-6 8-9	OPEN	2-1, 5-4 8-7

( ) = Momentary

### 4PDT



SCHEMATIC

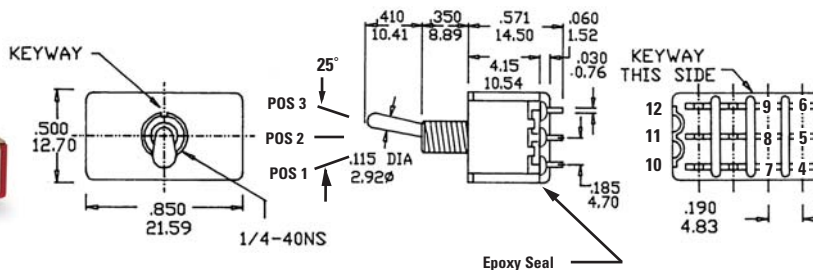

Model No.	POS 1	POS 2	POS 3
4P-1	ON	NONE	ON
4P-2	ON	NONE	(ON)
4P-3	ON	OFF	ON
4P-4	(ON)	OFF	(ON)
4P-5	ON	OFF	(ON)
4P-7	ON	ON	(ON)
4P-8	(ON)	ON	(ON)
Term. Comm.	2-3, 5-6 8-9 11-12	OPEN	2-1, 5-4 8-7 11-10

4P-6	ON	ON	ON
Term. Comm.	2-3, 5-6 8-9 11-12	2-3, 5-4 8-9 11-10	2-1, 5-4 8-7 11-10

( ) = Momentary

# SERIES 100 SWITCHES

## TOGGLE SWITCHES - MINIATURE

### 3 - WAY WIRING DIAGRAM SCHEMATICS



Bottom View  
or DP-6, DP-7, DP-8



Bottom View  
for 4P-6, 4P-7, 4P-8



### ACTUATOR OPTIONS

**T1\*** STANDARD



**T2\***

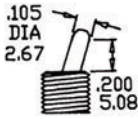

**T3\***



**T4\***

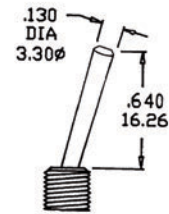

**T5\***



**T6** FLATTED WITH BUILT IN ANTIROTATION

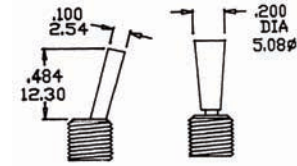

Use with B11, B12, B15, B16 only

**T7**

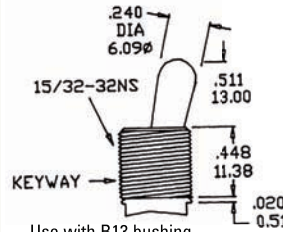

Use with B13 bushing

**T8**

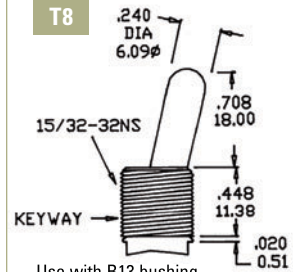

Use with B13 bushing

**T9\*** PLASTIC BLACK

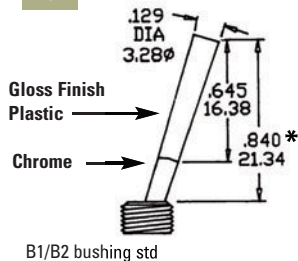

**K1**

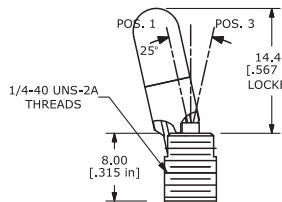

**K2**

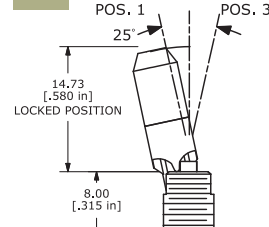

\*Add .070 (1.78) for B3, B4 bushings, subtract .020 (0.51) for B6 bushing.



### BUSHING OPTIONS

**B1 THD STD**

**B2 NON-THD**



**B3 THD STD**

**B4 NON-THD**



B4 is standard for M6, M7 and VS termination options.

**B5 HIGH TORQUE**

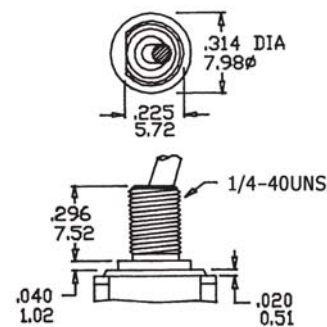

**B6 HIGH TORQUE**



**B8 METRIC THD**



**B9 SPLASH PROOF**



**B13**



Use with T7 and T8 actuators only

**B11 THD STD**

**B12 NON-THD**



Use with T6 actuator only

**B15 THD STD**

**B16 NON-THD**

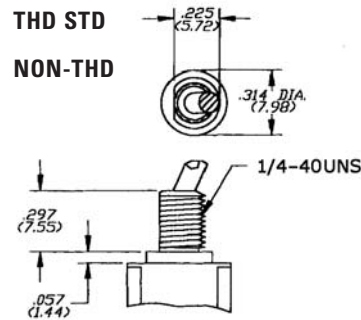

Use with T6 actuator only

**B25**



**B26**

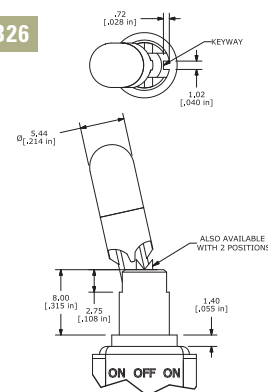

# SERIES 100 SWITCHES

## TOGGLE SWITCHES - MINIATURE

### BUSHING OPTIONS - PANEL MOUNTING



### TERMINATION OPTIONS

#### M2

##### SPDT

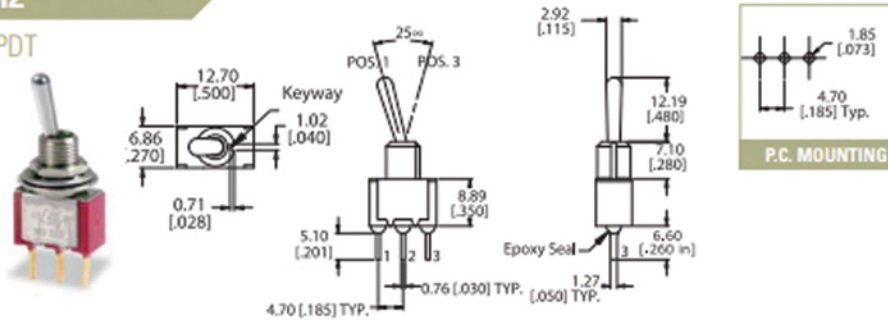

#### M1

##### SOLDER LUG

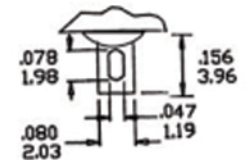

#### M3

##### QUICK CONNECT

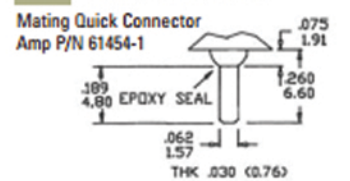

#### M2

##### DPDT

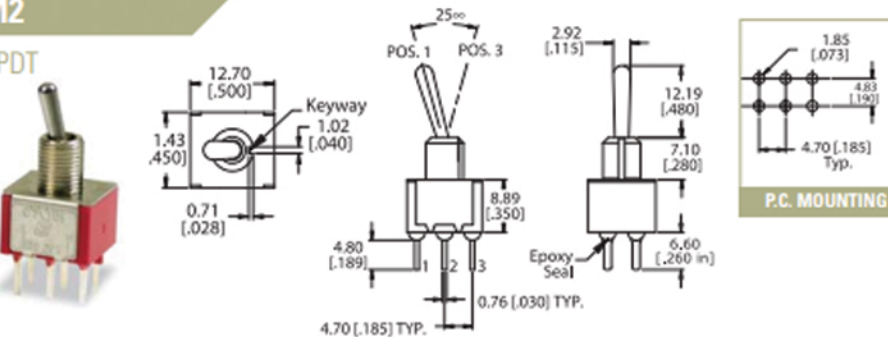

#### M5

##### WIRE WRAP

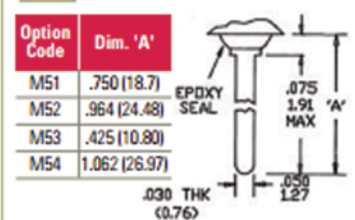

#### M6

##### SPDT

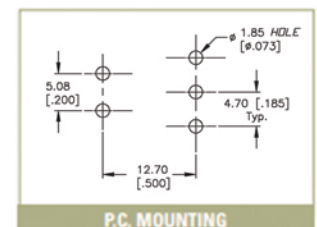
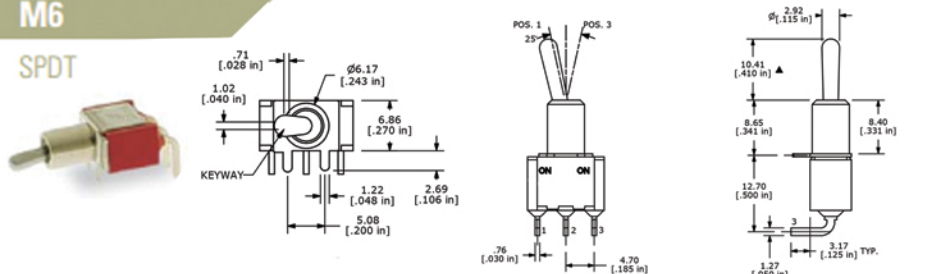



### M6

DPDT



P.C. MOUNTING

### M7

SPDT

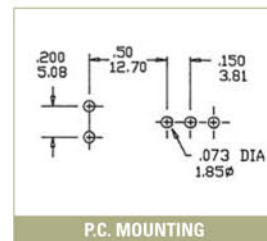

P.C. MOUNTING

### M7

DPDT

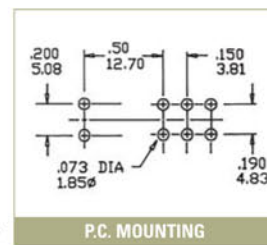

P.C. MOUNTING

### M7

3PDT

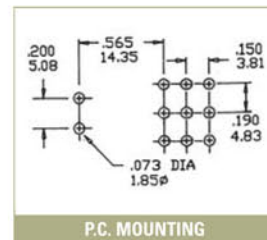

P.C. MOUNTING

### M7

4PDT

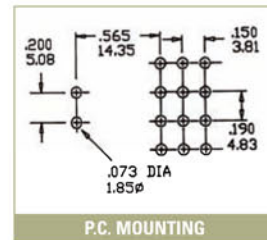
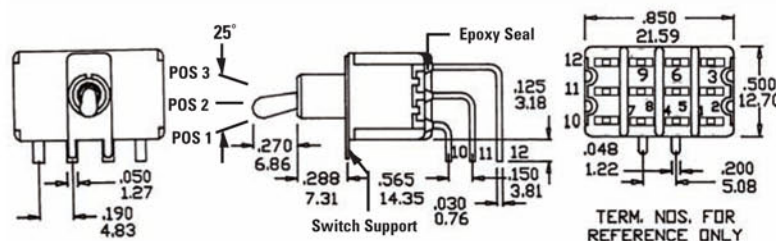

P.C. MOUNTING

# SERIES 100 SWITCHES

## TOGGLE SWITCHES - MINIATURE

TACT SWITCHES

NAVIGATION SWITCHES

PUSHBUTTON SWITCHES

TOGGLE SWITCHES

ROCKER SWITCHES

SLIDE SWITCHES

SNAP-ACTION SWITCHES

DIP SWITCHES

KEYLOCK SWITCHES

ROTARY SWITCHES

DETECTOR SWITCHES

CAP OPTIONS

### VS2-VS3

SPDT



Option Code	Dim. 'A'
VS2	.460 (11.68)
VS3	.630 (16.00)



### VS2-VS3

DPDT



Option Code	Dim. 'A'
VS2	.460 (11.68)
VS3	.630 (16.00)



### VS5

DPDT



Option Code	Dim. 'A'
VS5	.630 (16.00)



### M61

SPDT

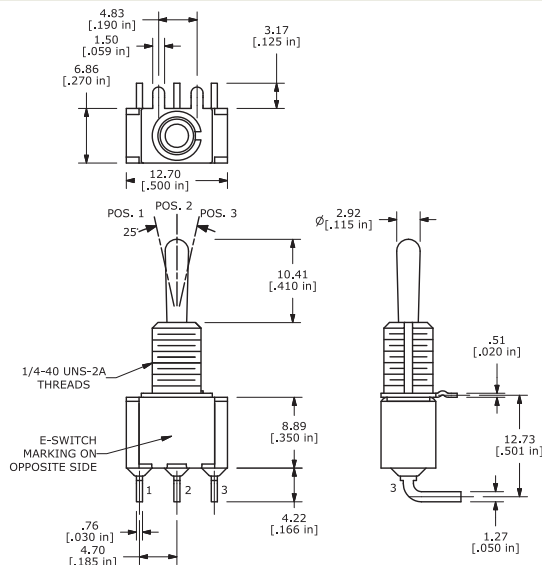



### M61

DPDT



### M71

SPDT



### M64

SPDT

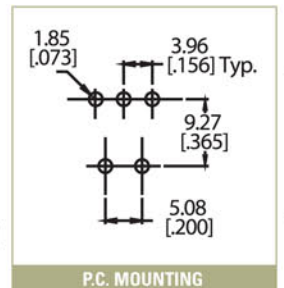

TACT SWITCHES

NAVIGATION SWITCHES

PUSHBUTTON SWITCHES

TOGGLE SWITCHES

ROCKER SWITCHES

SLIDE SWITCHES

SNAP-ACTION SWITCHES

DIP SWITCHES

KEYLOCK SWITCHES

ROTARY SWITCHES

DETECTOR SWITCHES

CAP OPTIONS



# SERIES 100 SWITCHES

## TOGGLE SWITCHES - MINIATURE

### VS21-VS31

SPDT



Option Code	Dim. 'A'
VS2	.460 (11.68)
VS3	.630 (16.00)



P.C. MOUNTING

### VS21-VS31

DPDT



Option Code	Dim. 'A'
VS2	.460 (11.68)
VS3	.630 (16.00)



P.C. MOUNTING

### OPTIONAL TOGGLE CAP



Use with T1  
T100-1 WHITE  
T100-2 BLACK

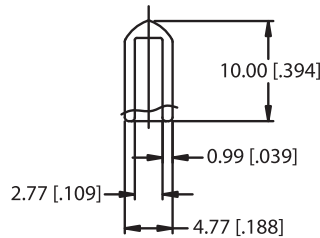

### CONTACT MATERIAL OPTIONS

**Q**

Fixed Terminal:	Silver plated over copper alloy
Moving Contact:	Silver plated over copper alloy
Rating:	5 Amps with resistive load @ 120VAC or 28VDC; 2 Amps with resistive load @ 250VAC

**R**

Fixed Terminal:	Copper alloy with gold plate over nickel plate
Moving Contact:	Copper alloy with gold plate over nickel plate
Rating:	0.4 Volt-Amps (VA) max. @ 20V max. (AC or DC)



**HARDWARE**

**HDW2 1/4 IN. NUTS**



Supplied standard with B1, B3, B5, B6 and B9 options

**HDW3 BLIND DRESSNUT**

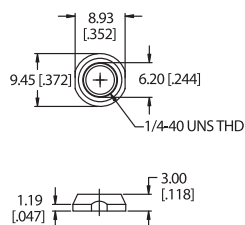

**HDW6 METRIC NUT**



Supplied standard with B8 metric bushing

**HDW11 LOCK WASHER**



Supplied standard with B1/B3 bushing

**Optional Rubber Hood Sealing E1**



E1= Inch (Std.) for actuator T1, T2 and bushings B1, B3, B5, B6 Optional rubber boot sealing

**HDW4 15/32 IN. NUTS**

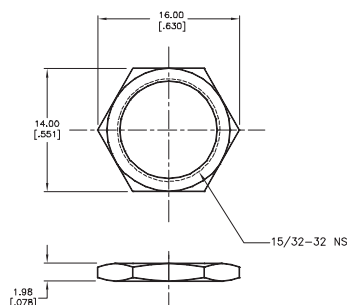

Supplied standard with B13 bushing

**HDW12 LOCK WASHER**



Supplied standard with B13 bushing

**HDW15 LOCKING RING**

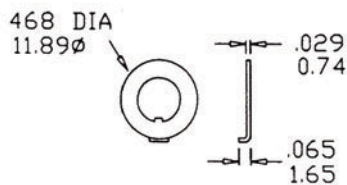

Supplied standard

**HDW16 LOCKING RING**

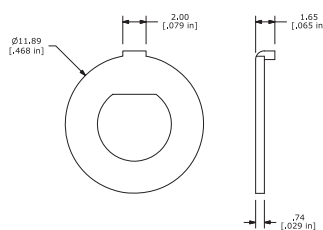

Supplied with B5 bushing

**HDW17 LOCKING RING**



Supplied with B13 bushing

TACT SWITCHES

NAVIGATION SWITCHES

PUSHBUTTON SWITCHES

TOGGLE SWITCHES

ROCKER SWITCHES

SLIDE SWITCHES

SNAP-ACTION SWITCHES

DIP SWITCHES

KEYLOCK SWITCHES

ROTARY SWITCHES

DETECTOR SWITCHES

CAP OPTIONS



Компания «ЭлектроПласт» предлагает заключение долгосрочных отношений при поставках импортных электронных компонентов на взаимовыгодных условиях!

Наши преимущества:

- Оперативные поставки широкого спектра электронных компонентов отечественного и импортного производства напрямую от производителей и с крупнейших мировых складов;
- Поставка более 17-ти миллионов наименований электронных компонентов;
- Поставка сложных, дефицитных, либо снятых с производства позиций;
- Оперативные сроки поставки под заказ (от 5 рабочих дней);
- Экспресс доставка в любую точку России;
- Техническая поддержка проекта, помощь в подборе аналогов, поставка прототипов;
- Система менеджмента качества сертифицирована по Международному стандарту ISO 9001;
- Лицензия ФСБ на осуществление работ с использованием сведений, составляющих государственную тайну;
- Поставка специализированных компонентов (Xilinx, Altera, Analog Devices, Intersil, Interpoint, Microsemi, Aeroflex, Peregrine, Syfer, Eurofarad, Texas Instrument, Miteq, Cobham, E2V, MA-COM, Hittite, Mini-Circuits, General Dynamics и др.);

Помимо этого, одним из направлений компании «ЭлектроПласт» является направление «Источники питания». Мы предлагаем Вам помощь Конструкторского отдела:

- Подбор оптимального решения, техническое обоснование при выборе компонента;
- Подбор аналогов;
- Консультации по применению компонента;
- Поставка образцов и прототипов;
- Техническая поддержка проекта;
- Защита от снятия компонента с производства.



#### Как с нами связаться

**Телефон:** 8 (812) 309 58 32 (многоканальный)

**Факс:** 8 (812) 320-02-42

**Электронная почта:** [org@eplast1.ru](mailto:org@eplast1.ru)

**Адрес:** 198099, г. Санкт-Петербург, ул. Калинина, дом 2, корпус 4, литера А.