

# SERIES 100 SWITCHES

## TOGGLE SWITCHES - MINIATURE

US



### SPECIFICATIONS

|                        |   |
|------------------------|---|
| Contact Rating:        | See contact material options  |
| Life Expectancy:       | 40,000 make-and-break cycles  |
| Contact Resistance:    | 10 mΩ max. typical initial @ 2-4 VDC<br>100 mA for both silver and gold plated contacts |
| Insulation Resistance: | 1,000 MΩ min.   |
| Dielectric Strength:   | 1,000 V RMS @ sea level   |
| Operating Temperature: | -30° C to 85° C   |

### MATERIALS

|                       |                                    |
|-----------------------|------------------------------------|
| Case:                 | Diallyl Phthalate (DAP)            |
| Toggle Handle:        | Brass, chrome plated               |
| Switch Support:       | Brass or steel, tin plated         |
| Bushing:              | Brass, nickel plated               |
| Housing:              | Stainless steel                    |
| Contacts / Terminals: | Silver or gold plated copper alloy |

### FEATURES & BENEFITS

- ▶ Up to 4 poles available
- ▶ Variety of switching functions
- ▶ Miniature
- ▶ Multiple actuator & bushing options

### APPLICATIONS/MARKETS

- ▶ Telecommunications
- ▶ Instrumentation
- ▶ Networking
- ▶ Medical equipment

### HOW TO ORDER

| SERIES | MODEL NO.  | ACTUATOR  | BUSHING   | TERMINATION  | CONTACT MATERIAL       | SEAL  | HARDWARE     |
|--------|--|---|---|--|------------------------|---|--------------|
| 100    | □ □ □  | □ □   | □ □ □   | □ □ □ □  | □                      | E   | □            |
|        | SP1<br>SP2*<br>SP3<br>SP4*<br>SP5*<br>DP1<br>DP2*<br>DP3<br>DP4*<br>DP5*<br>DP6<br>DP7*<br>DP8*<br>3P1<br>3P2*<br>3P3<br>3P4*<br>3P5*<br>4P1<br>4P2*<br>4P3<br>4P4*<br>4P5*<br>4P6<br>4P7*<br>4P8* | T1†<br>T2<br>T3<br>T4<br>T5<br>T6<br>T7<br>T8<br>T9<br>K1<br>K2<br><br>† Optional<br>Toggle Cap<br>(T1 Only):<br>T100-1 = White<br>T100-2 = Black | B1<br>B2<br>B3<br>B4<br>B5<br>B6<br>B8<br>B9<br>B11<br>B12<br>B13<br>B15<br>B16<br>B25**<br>B26** | M1<br>M2<br>M3<br>M5<br>M6<br>M61<br>M7<br>M71<br>VS2<br>VS3<br>VS5*<br>M64*<br>VS21*<br>VS31* | Q = Silver<br>R = Gold | E = Epoxy<br>Sealed at<br>Base of<br>Terminal | H = Hardware |

Example Ordering Number  
100-SP1-T4-B2-M1-R-E

Notes: \* Not available with the K1 and K2 actuator options.

\*\* Available only with the K1 and K2 actuator options.

Specifications subject to change without notice.



### SPDT



SCHEMATIC



| Model No.   | POS 1 | POS 2 | POS 3 |
|-------------|-------|-------|-------|
| SP-1        | ON    | NONE  | ON    |
| SP-2        | ON    | NONE  | (ON)  |
| SP-3        | ON    | OFF   | ON    |
| SP-4        | (ON)  | OFF   | (ON)  |
| SP-5        | ON    | OFF   | (ON)  |
| Term. Comm. | 2-3   | OPEN  | 2-1   |

( ) = Momentary

### DPDT



SCHEMATIC



| Model No.   | POS 1    | POS 2 | POS 3    |
|-------------|----------|-------|----------|
| DP-1        | ON       | NONE  | ON       |
| DP-2        | ON       | NONE  | (ON)     |
| DP-3        | ON       | OFF   | ON       |
| DP-4        | (ON)     | OFF   | (ON)     |
| DP-5        | ON       | OFF   | (ON)     |
| DP-7        | ON       | ON    | (ON)     |
| DP-8        | (ON)     | ON    | (ON)     |
| Term. Comm. | 2-3, 5-6 | OPEN  | 2-1, 5-4 |

|             |          |          |          |
|-------------|----------|----------|----------|
| DP-6        | ON       | ON       | ON       |
| Term. Comm. | 2-3, 5-6 | 2-3, 5-4 | 2-1, 5-4 |

( ) = Momentary

### 3PDT



SCHEMATIC

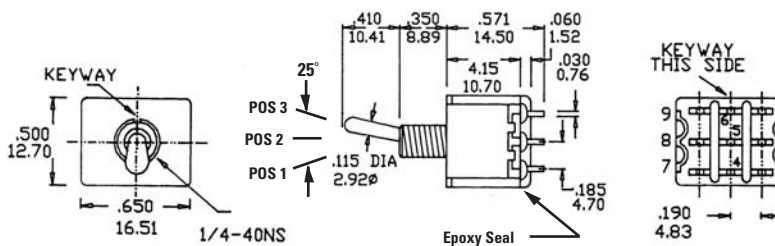

| Model No.   | POS 1           | POS 2 | POS 3           |
|-------------|-----------------|-------|-----------------|
| 3P-1        | ON              | NONE  | ON              |
| 3P-2        | ON              | NONE  | (ON)            |
| 3P-3        | ON              | OFF   | ON              |
| 3P-4        | (ON)            | OFF   | (ON)            |
| 3P-5        | ON              | OFF   | (ON)            |
| Term. Comm. | 2-3, 5-6<br>8-9 | OPEN  | 2-1, 5-4<br>8-7 |

( ) = Momentary

### 4PDT

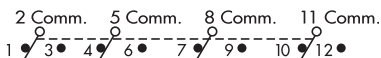

SCHEMATIC

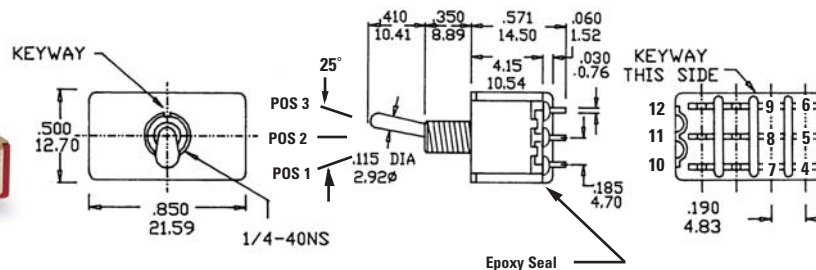

| Model No.   | POS 1                    | POS 2 | POS 3                    |
|-------------|--------------------------|-------|--------------------------|
| 4P-1        | ON                       | NONE  | ON                       |
| 4P-2        | ON                       | NONE  | (ON)                     |
| 4P-3        | ON                       | OFF   | ON                       |
| 4P-4        | (ON)                     | OFF   | (ON)                     |
| 4P-5        | ON                       | OFF   | (ON)                     |
| 4P-7        | ON                       | ON    | (ON)                     |
| 4P-8        | (ON)                     | ON    | (ON)                     |
| Term. Comm. | 2-3, 5-6<br>8-9<br>11-12 | OPEN  | 2-1, 5-4<br>8-7<br>11-10 |

|             |                          |                          |                          |
|-------------|--------------------------|--------------------------|--------------------------|
| 4P-6        | ON                       | ON                       | ON                       |
| Term. Comm. | 2-3, 5-6<br>8-9<br>11-12 | 2-3, 5-4<br>8-9<br>11-10 | 2-1, 5-4<br>8-7<br>11-10 |

( ) = Momentary

# SERIES 100 SWITCHES

## TOGGLE SWITCHES - MINIATURE

### 3 - WAY WIRING DIAGRAM SCHEMATICS



Bottom View  
or DP-6, DP-7, DP-8

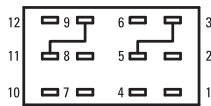

Bottom View  
for 4P-6, 4P-7, 4P-8



### ACTUATOR OPTIONS

**T1\*** STANDARD



**T2\***



**T3\***



**T4\***



**T5\***

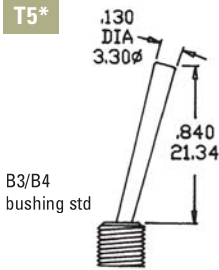

**T6** FLATTED WITH BUILT IN ANTIROTATION

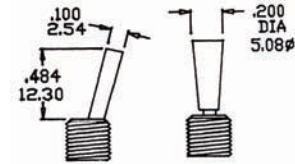

Use with B11, B12, B15, B16 only

**T7**

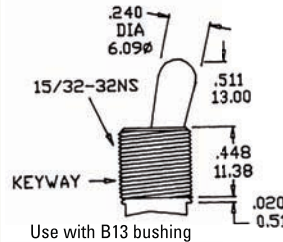

**T8**

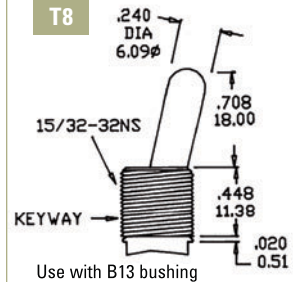

**T9\*** PLASTIC BLACK



**K1**



**K2**



\*Add .070 (1.78) for B3, B4 bushings, subtract .020 (0.51) for B6 bushing.



### BUSHING OPTIONS

**B1 THD STD**

**B2 NON-THD**



**B3 THD STD**

**B4 NON-THD**



B4 is standard for M6, M7 and VS termination options.

**B5 HIGH TORQUE**



**B6 HIGH TORQUE**



**B8 METRIC THD**

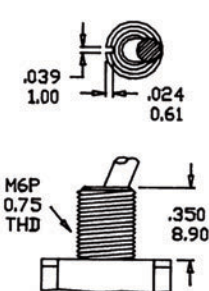

**B9 SPLASH PROOF**



**B13**



Use with T7 and T8 actuators only

**B11 THD STD**

**B12 NON-THD**

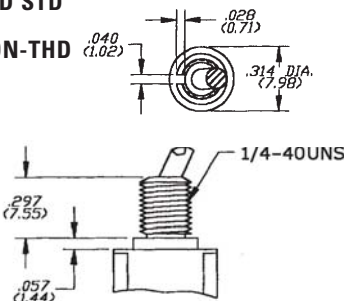

Use with T6 actuator only

**B15 THD STD**

**B16 NON-THD**

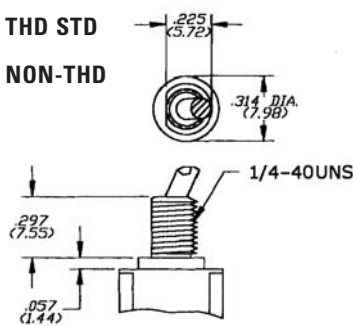

Use with T6 actuator only

**B25**



**B26**



# SERIES 100 SWITCHES

## TOGGLE SWITCHES - MINIATURE

### BUSHING OPTIONS - PANEL MOUNTING



### TERMINATION OPTIONS

#### M2

#### SPDT

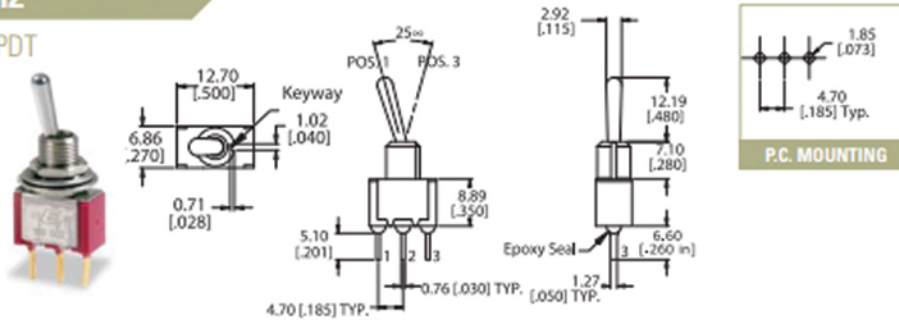

#### M1

#### SOLDER LUG

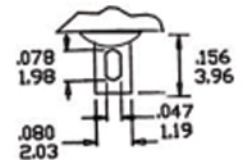

#### M3

#### QUICK CONNECT

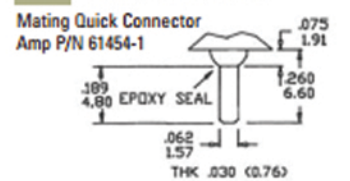

#### M2

#### DPDT

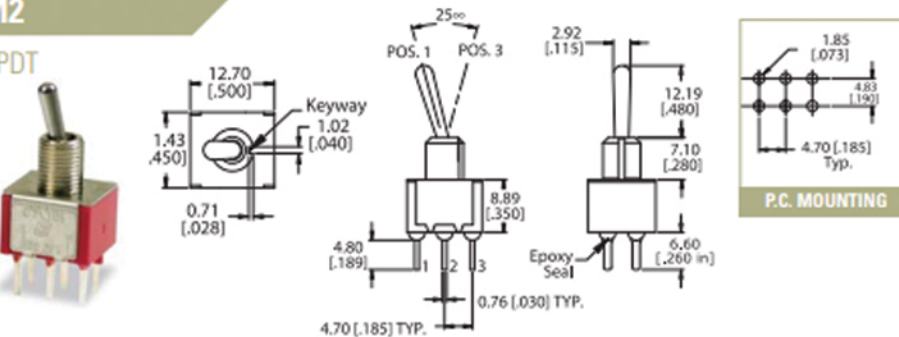

#### M5

#### WIRE WRAP

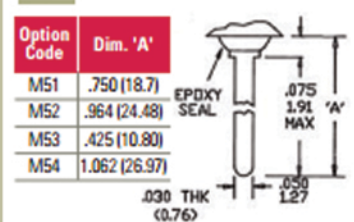

#### M6

#### SPDT

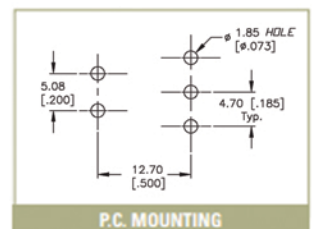
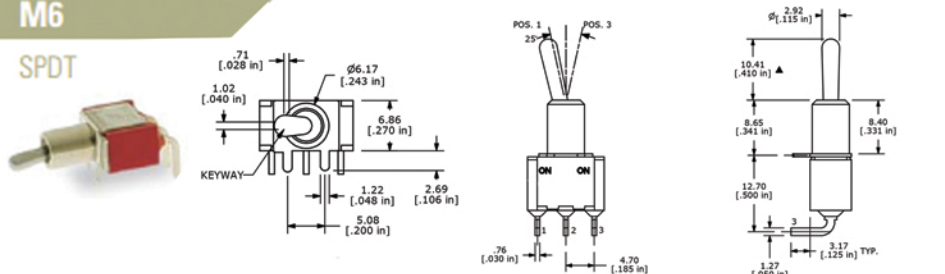



### M6

DPDT

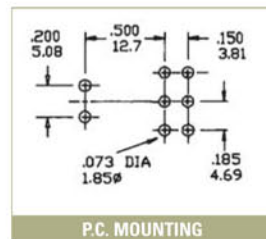
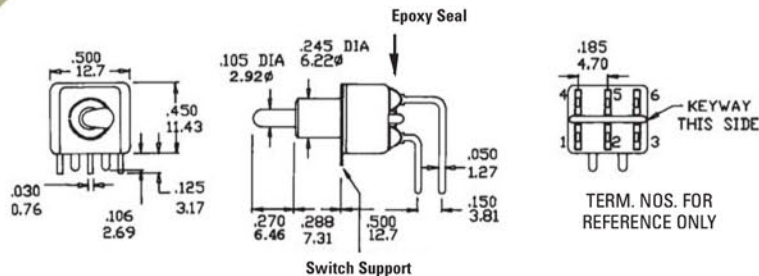

P.C. MOUNTING

### M7

SPDT

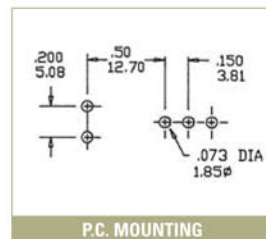

P.C. MOUNTING

### M7

DPDT

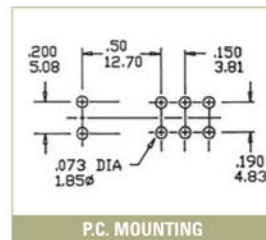
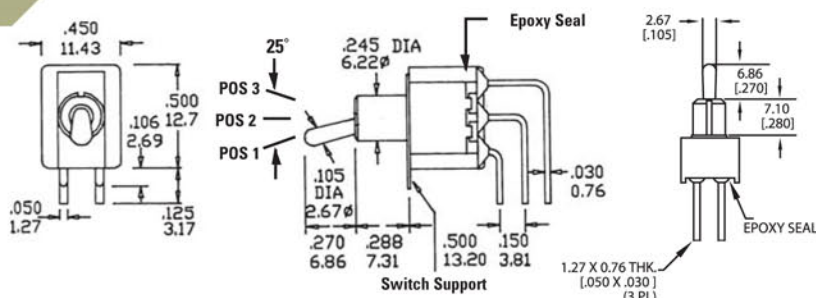

P.C. MOUNTING

### M7

3PDT

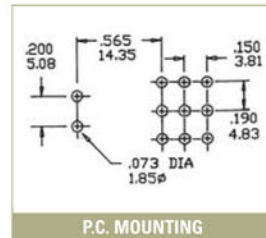

P.C. MOUNTING

### M7

4PDT

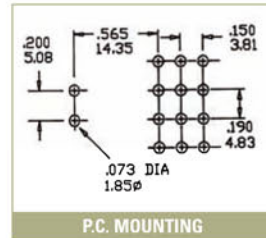
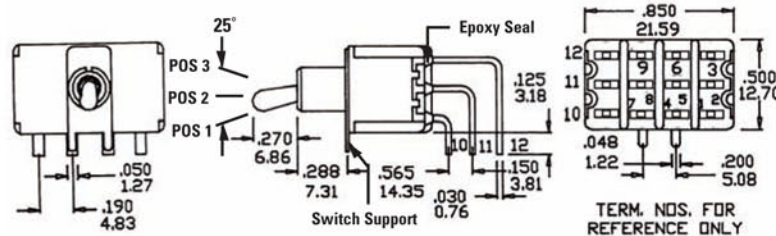

P.C. MOUNTING

# SERIES 100 SWITCHES

## TOGGLE SWITCHES - MINIATURE

TACT  
SWITCHES

NAVIGATION  
SWITCHES

PUSHBUTTON  
SWITCHES

TOGGLE  
SWITCHES

ROCKER  
SWITCHES

SLIDE  
SWITCHES

SNAP-ACTION  
SWITCHES

DIP  
SWITCHES

KEYLOCK  
SWITCHES

ROTARY  
SWITCHES

DETECTOR  
SWITCHES

CAP  
OPTIONS

### VS2-VS3

SPDT



| Option Code | Dim. 'A'     |
|-------------|--------------|
| VS2         | .460 (11.68) |
| VS3         | .630 (16.00) |



### VS2-VS3

DPDT



| Option Code | Dim. 'A'     |
|-------------|--------------|
| VS2         | .460 (11.68) |
| VS3         | .630 (16.00) |



### VS5

DPDT

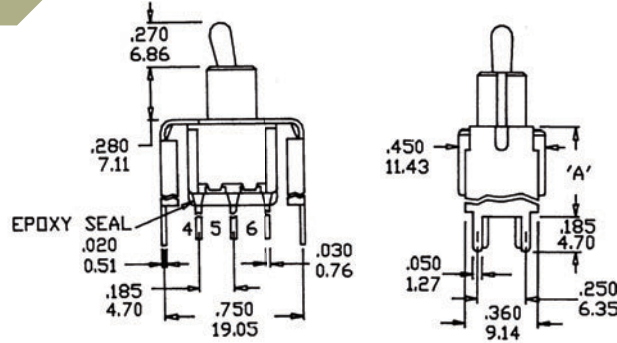

| Option Code | Dim. 'A'     |
|-------------|--------------|
| VS5         | .630 (16.00) |



### M61

SPDT





### M61

DPDT



### M71

SPDT

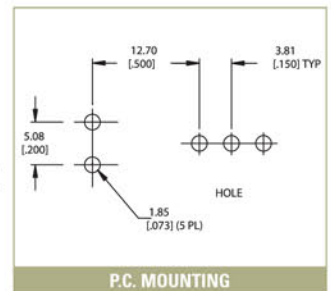

### M64

SPDT

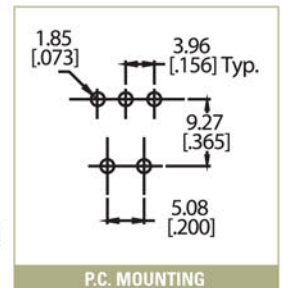

TACT SWITCHES

NAVIGATION SWITCHES

PUSHBUTTON SWITCHES

TOGGLE SWITCHES

ROCKER SWITCHES

SLIDE SWITCHES

SNAP-ACTION SWITCHES

DIP SWITCHES

KEYLOCK SWITCHES

ROTARY SWITCHES

DETECTOR SWITCHES

CAP OPTIONS



# SERIES 100 SWITCHES

## TOGGLE SWITCHES - MINIATURE

### VS21-VS31

SPDT



| Option Code | Dim. 'A'     |
|-------------|--------------|
| VS2         | .460 (11.68) |
| VS3         | .630 (16.00) |



P.C. MOUNTING

### VS21-VS31

DPDT



| Option Code | Dim. 'A'     |
|-------------|--------------|
| VS2         | .460 (11.68) |
| VS3         | .630 (16.00) |



P.C. MOUNTING

### OPTIONAL TOGGLE CAP



Use with T1  
T100-1 WHITE  
T100-2 BLACK



### CONTACT MATERIAL OPTIONS

**Q**

|                 |  |
|-----------------|--|
| Fixed Terminal: | Silver plated over copper alloy  |
| Moving Contact: | Silver plated over copper alloy  |
| Rating:         | 5 Amps with resistive load @ 120VAC or 28VDC;<br>2 Amps with resistive load @ 250VAC |

**R**

|                 |  |
|-----------------|--|
| Fixed Terminal: | Copper alloy with gold plate over nickel plate |
| Moving Contact: | Copper alloy with gold plate over nickel plate |
| Rating:         | 0.4 Volt-Amps (VA) max. @ 20V max. (AC or DC)  |



**HARDWARE**

**HDW2 1/4 IN. NUTS**



Supplied standard with B1, B3, B5, B6 and B9 options

**HDW3 BLIND DRESSNUT**



**HDW6 METRIC NUT**



Supplied standard with B8 metric bushing

**HDW11 LOCK WASHER**



Supplied standard with B1/B3 bushing

**Optional Rubber Hood Sealing E1**



E1= Inch (Std.) for actuator T1, T2 and bushings B1, B3, B5, B6 Optional rubber boot sealing

**HDW4 15/32 IN. NUTS**



Supplied standard with B13 bushing

**HDW12 LOCK WASHER**



Supplied standard with B13 bushing

**HDW15 LOCKING RING**



Supplied standard

**HDW16 LOCKING RING**



Supplied with B5 bushing

**HDW17 LOCKING RING**



Supplied with B13 bushing

TACT SWITCHES

NAVIGATION SWITCHES

PUSHBUTTON SWITCHES

TOGGLE SWITCHES

ROCKER SWITCHES

SLIDE SWITCHES

SNAP-ACTION SWITCHES

DIP SWITCHES

KEYLOCK SWITCHES

ROTARY SWITCHES

DETECTOR SWITCHES

CAP OPTIONS



Компания «ЭлектроПласт» предлагает заключение долгосрочных отношений при поставках импортных электронных компонентов на взаимовыгодных условиях!

Наши преимущества:

- Оперативные поставки широкого спектра электронных компонентов отечественного и импортного производства напрямую от производителей и с крупнейших мировых складов;
- Поставка более 17-ти миллионов наименований электронных компонентов;
- Поставка сложных, дефицитных, либо снятых с производства позиций;
- Оперативные сроки поставки под заказ (от 5 рабочих дней);
- Экспресс доставка в любую точку России;
- Техническая поддержка проекта, помощь в подборе аналогов, поставка прототипов;
- Система менеджмента качества сертифицирована по Международному стандарту ISO 9001;
- Лицензия ФСБ на осуществление работ с использованием сведений, составляющих государственную тайну;
- Поставка специализированных компонентов (Xilinx, Altera, Analog Devices, Intersil, Interpoint, Microsemi, Aeroflex, Peregrine, Syfer, Eurofarad, Texas Instrument, Miteq, Cobham, E2V, MA-COM, Hittite, Mini-Circuits, General Dynamics и др.);

Помимо этого, одним из направлений компании «ЭлектроПласт» является направление «Источники питания». Мы предлагаем Вам помощь Конструкторского отдела:

- Подбор оптимального решения, техническое обоснование при выборе компонента;
- Подбор аналогов;
- Консультации по применению компонента;
- Поставка образцов и прототипов;
- Техническая поддержка проекта;
- Защита от снятия компонента с производства.



#### Как с нами связаться

**Телефон:** 8 (812) 309 58 32 (многоканальный)

**Факс:** 8 (812) 320-02-42

**Электронная почта:** [org@eplast1.ru](mailto:org@eplast1.ru)

**Адрес:** 198099, г. Санкт-Петербург, ул. Калинина, дом 2, корпус 4, литера А.