

SERIES 100 SWITCHES

TOGGLE SWITCHES - MINIATURE



SPECIFICATIONS

Contact Rating:	See contact material options
Life Expectancy:	40,000 make-and-break cycles
Contact Resistance:	10 mΩ max. typical initial @ 2-4 VDC 100 mA for both silver and gold plated contacts
Insulation Resistance:	1,000 MΩ min.
Dielectric Strength:	1,000 V RMS @ sea level
Operating Temperature:	-30° C to 85° C

MATERIALS

Case:	Diallyl Phthalate (DAP)
Toggle Handle:	Brass, chrome plated
Switch Support:	Brass or steel, tin plated
Bushing:	Brass, nickel plated
Housing:	Stainless steel
Contacts / Terminals:	Silver or gold plated copper alloy

FEATURES & BENEFITS

- ▶ Up to 4 poles available
- ▶ Variety of switching functions
- ▶ Miniature
- ▶ Multiple actuator & bushing options

APPLICATIONS/MARKETS

- ▶ Telecommunications
- ▶ Instrumentation
- ▶ Networking
- ▶ Medical equipment

HOW TO ORDER

SERIES 100	MODEL NO.	ACTUATOR	BUSHING	TERMINATION	CONTACT MATERIAL	SEAL E	HARDWARE
	SP1	T1†	B1	M1	Q = Silver R = Gold	E = Epoxy Sealed at Base of Terminal	H = Hardware
	SP2*	T2	B2	M2			
	SP3	T3	B3	M3			
	SP4*	T4	B4	M5			
	SP5*	T5	B5	M6			
	DP1	T6	B6	M61			
	DP2*	T7	B8	M7			
	DP3	T8	B9	M71			
	DP4*	T9	B11	VS2			
	DP5*	K1	B12	VS3			
	DP6	K2	B13	VS5*			
	DP7*		B15	M64*			
	DP8*	† Optional Toggle Cap (T1 Only): T100-1 = White T100-2 = Black	B16	VS21*			
	3P1		B25**	VS31*			
	3P2*		B26**				
	3P3						
	3P4*						
	3P5*						
	4P1						
	4P2*						
	4P3						
	4P4*						
	4P5*						
	4P6						
	4P7*						
	4P8*						

▶ ▶ ▶ Example Ordering Number
100-SP1-T4-B2-M1-R-E

Notes: * Not available with the K1 and K2 actuator options.

** Available only with the K1 and K2 actuator options.

Specifications subject to change without notice.

SPDT



SCHEMATIC

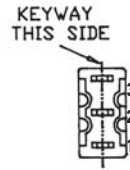

Model No.	POS 1	POS 2	POS 3
SP-1	ON	NONE	ON
SP-2	ON	NONE	(ON)
SP-3	ON	OFF	ON
SP-4	(ON)	OFF	(ON)
SP-5	ON	OFF	(ON)
Term. Comm.	2-3	OPEN	2-1

() = Momentary

DPDT



SCHEMATIC

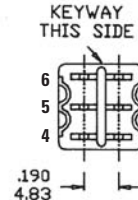

Model No.	POS 1	POS 2	POS 3
DP-1	ON	NONE	ON
DP-2	ON	NONE	(ON)
DP-3	ON	OFF	ON
DP-4	(ON)	OFF	(ON)
DP-5	ON	OFF	(ON)
DP-7	ON	ON	(ON)
DP-8	(ON)	ON	(ON)
Term. Comm.	2-3, 5-6	OPEN	2-1, 5-4

DP-6	ON	ON	ON
Term. Comm.	2-3, 5-6	2-3, 5-4	2-1, 5-4

() = Momentary

3PDT



SCHEMATIC

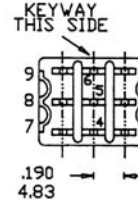
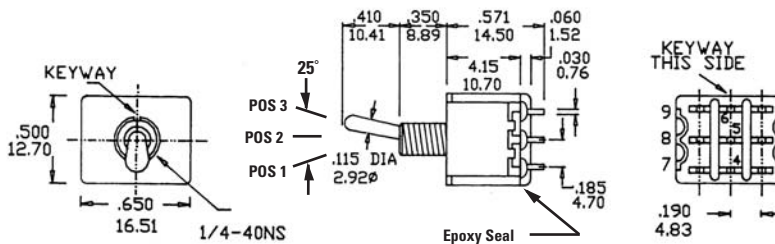

Model No.	POS 1	POS 2	POS 3
3P-1	ON	NONE	ON
3P-2	ON	NONE	(ON)
3P-3	ON	OFF	ON
3P-4	(ON)	OFF	(ON)
3P-5	ON	OFF	(ON)
Term. Comm.	2-3, 5-6 8-9	OPEN	2-1, 5-4 8-7

() = Momentary

4PDT

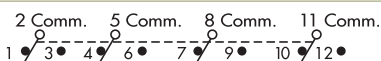

SCHEMATIC

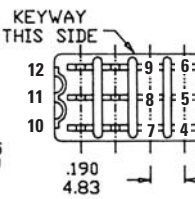
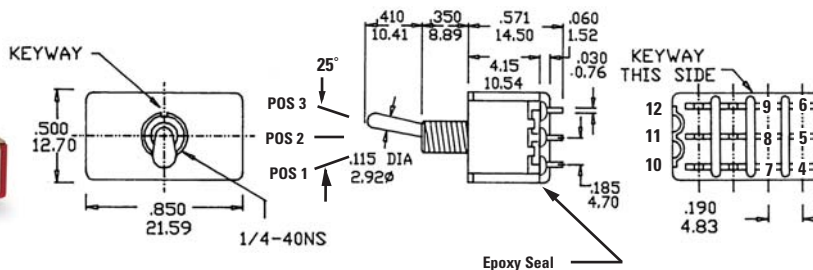

Model No.	POS 1	POS 2	POS 3
4P-1	ON	NONE	ON
4P-2	ON	NONE	(ON)
4P-3	ON	OFF	ON
4P-4	(ON)	OFF	(ON)
4P-5	ON	OFF	(ON)
4P-7	ON	ON	(ON)
4P-8	(ON)	ON	(ON)
Term. Comm.	2-3, 5-6 8-9 11-12	OPEN	2-1, 5-4 8-7 11-10

4P-6	ON	ON	ON
Term. Comm.	2-3, 5-6 8-9 11-12	2-3, 5-4 8-9 11-10	2-1, 5-4 8-7 11-10

() = Momentary

SERIES 100 SWITCHES

TOGGLE SWITCHES - MINIATURE

3 - WAY WIRING DIAGRAM SCHEMATICS



ACTUATOR OPTIONS



*Add .070 (1.78) for B3, B4 bushings, subtract .020 (0.51) for B6 bushing.



BUSHING OPTIONS

B1 THD STD

B2 NON-THD



B3 THD STD

B4 NON-THD



B4 is standard for M6, M7 and VS termination options.

B5 HIGH TORQUE



B6 HIGH TORQUE



B8 METRIC THD



B9 SPLASH PROOF



B13



Use with T7 and T8 actuators only

B11 THD STD

B12 NON-THD



Use with T6 actuator only

B15 THD STD

B16 NON-THD



Use with T6 actuator only

B25



B26



SERIES 100 SWITCHES

TOGGLE SWITCHES - MINIATURE

BUSHING OPTIONS - PANEL MOUNTING

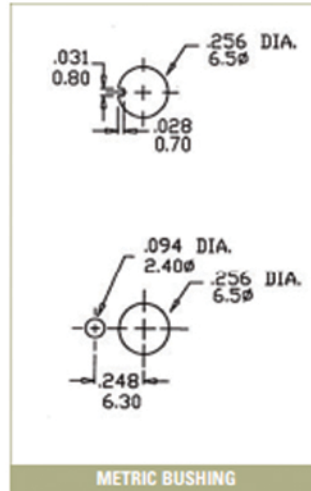
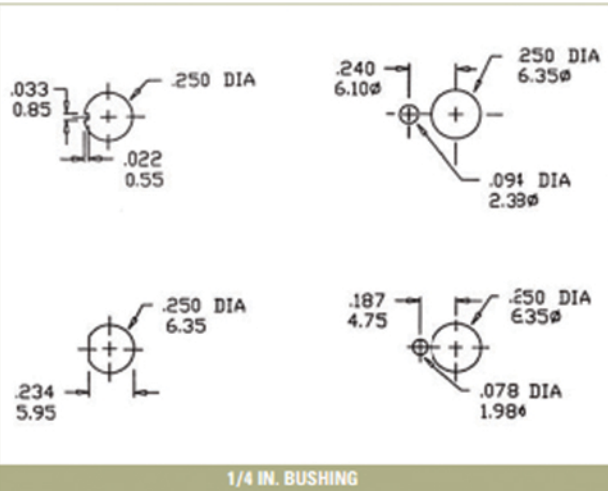

TERMINATION OPTIONS

M2

SPDT

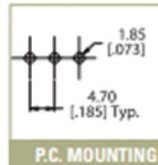

M1

SOLDER LUG

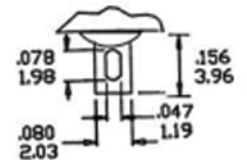

M3

QUICK CONNECT

Mating Quick Connector
Amp P/N 61454-1

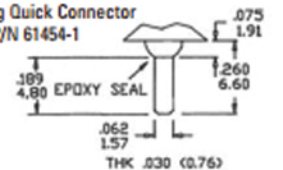

M2

DPDT

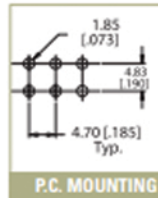

M5

WIRE WRAP

Option Code	Dim. 'A'
M51	.750 (18.7)
M52	.964 (24.48)
M53	.425 (10.80)
M54	1.062 (26.97)

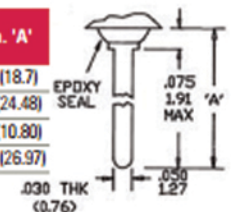

M6

SPDT





M6

DPDT

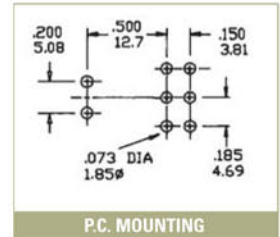

P.C. MOUNTING

M7

SPDT

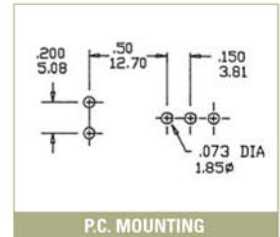

P.C. MOUNTING

M7

DPDT

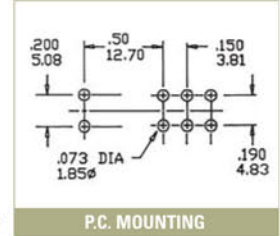

P.C. MOUNTING

M7

3PDT

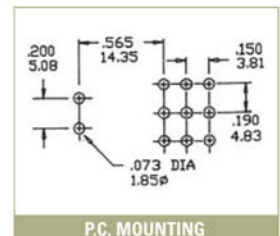

P.C. MOUNTING

M7

4PDT

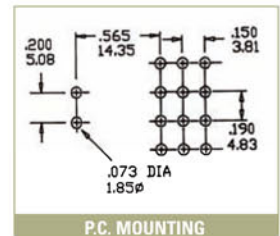

P.C. MOUNTING

SERIES 100 SWITCHES

TOGGLE SWITCHES - MINIATURE

TACT SWITCHES

NAVIGATION SWITCHES

PUSHBUTTON SWITCHES

TOGGLE SWITCHES

ROCKER SWITCHES

SLIDE SWITCHES

SNAP-ACTION SWITCHES

DIP SWITCHES

KEYLOCK SWITCHES

ROTARY SWITCHES

DETECTOR SWITCHES

CAP OPTIONS

VS2-VS3

SPDT



Option Code	Dim. 'A'
VS2	.460 (11.68)
VS3	.630 (16.00)



P.C. MOUNTING

VS2-VS3

DPDT



Option Code	Dim. 'A'
VS2	.460 (11.68)
VS3	.630 (16.00)



P.C. MOUNTING

VS5

DPDT



Option Code	Dim. 'A'
VS5	.630 (16.00)



P.C. MOUNTING

M61

SPDT

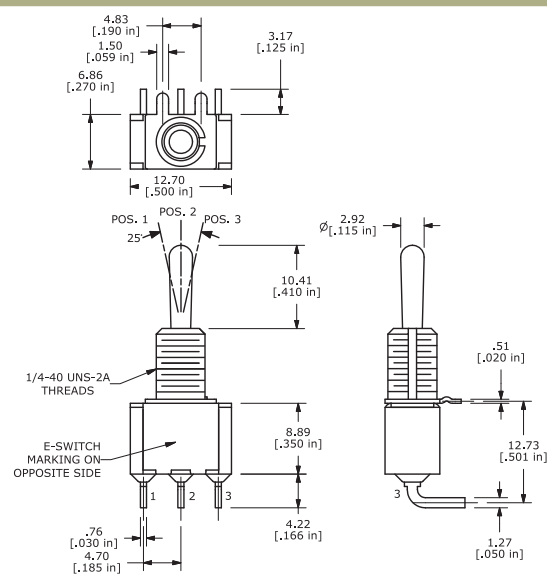

P.C. MOUNTING



M61

DPDT



M71

SPDT



M64

SPDT



TACT SWITCHES
 NAVIGATION SWITCHES
 PUSHBUTTON SWITCHES
 TOGGLE SWITCHES
 ROCKER SWITCHES
 SLIDE SWITCHES
 SNAP-ACTION SWITCHES
 DIP SWITCHES
 KEYLOCK SWITCHES
 ROTARY SWITCHES
 DETECTOR SWITCHES
 CAP OPTIONS

SERIES 100 SWITCHES

TOGGLE SWITCHES - MINIATURE

VS21-VS31

SPDT



Option Code	Dim. 'A'
VS2	.460 (11.68)
VS3	.630 (16.00)



P.C. MOUNTING

VS21-VS31

DPDT



Option Code	Dim. 'A'
VS2	.460 (11.68)
VS3	.630 (16.00)



P.C. MOUNTING

OPTIONAL TOGGLE CAP



Use with T1
T100-1 WHITE
T100-2 BLACK



CONTACT MATERIAL OPTIONS

Q

Fixed Terminal:	Silver plated over copper alloy
Moving Contact:	Silver plated over copper alloy
Rating:	5 Amps with resistive load @ 120VAC or 28VDC; 2 Amps with resistive load @ 250VAC

R

Fixed Terminal:	Copper alloy with gold plate over nickel plate
Moving Contact:	Copper alloy with gold plate over nickel plate
Rating:	0.4 Volt-Amps (VA) max. @ 20V max. (AC or DC)



HARDWARE

HDW2 1/4 IN. NUTS



Supplied standard with B1, B3, B5, B6 and B9 options

HDW3 BLIND DRESSNUT



HDW6 METRIC NUT



Supplied standard with B8 metric bushing

HDW11 LOCK WASHER



Supplied standard with B1/B3 bushing

Optional Rubber Hood Sealing E1



E1= Inch (Std.) for actuator T1, T2 and bushings B1, B3, B5, B6 Optional rubber boot sealing

HDW4 15/32 IN. NUTS



Supplied standard with B13 bushing

HDW12 LOCK WASHER



Supplied standard with B13 bushing

HDW15 LOCKING RING



Supplied standard

HDW16 LOCKING RING



Supplied with B5 bushing

HDW17 LOCKING RING



Supplied with B13 bushing

TACT SWITCHES

NAVIGATION SWITCHES

PUSHBUTTON SWITCHES

TOGGLE SWITCHES

ROCKER SWITCHES

SLIDE SWITCHES

SNAP-ACTION SWITCHES

DIP SWITCHES

KEYLOCK SWITCHES

ROTARY SWITCHES

DETECTOR SWITCHES

CAP OPTIONS



Компания «ЭлектроПласт» предлагает заключение долгосрочных отношений при поставках импортных электронных компонентов на взаимовыгодных условиях!

Наши преимущества:

- Оперативные поставки широкого спектра электронных компонентов отечественного и импортного производства напрямую от производителей и с крупнейших мировых складов;
- Поставка более 17-ти миллионов наименований электронных компонентов;
- Поставка сложных, дефицитных, либо снятых с производства позиций;
- Оперативные сроки поставки под заказ (от 5 рабочих дней);
- Экспресс доставка в любую точку России;
- Техническая поддержка проекта, помощь в подборе аналогов, поставка прототипов;
- Система менеджмента качества сертифицирована по Международному стандарту ISO 9001;
- Лицензия ФСБ на осуществление работ с использованием сведений, составляющих государственную тайну;
- Поставка специализированных компонентов (Xilinx, Altera, Analog Devices, Intersil, Interpoint, Microsemi, Aeroflex, Peregrine, Syfer, Eurofarad, Texas Instrument, Miteq, Cobham, E2V, MA-COM, Hittite, Mini-Circuits, General Dynamics и др.);

Помимо этого, одним из направлений компании «ЭлектроПласт» является направление «Источники питания». Мы предлагаем Вам помощь Конструкторского отдела:

- Подбор оптимального решения, техническое обоснование при выборе компонента;
- Подбор аналогов;
- Консультации по применению компонента;
- Поставка образцов и прототипов;
- Техническая поддержка проекта;
- Защита от снятия компонента с производства.



Как с нами связаться

Телефон: 8 (812) 309 58 32 (многоканальный)

Факс: 8 (812) 320-02-42

Электронная почта: org@eplast1.ru

Адрес: 198099, г. Санкт-Петербург, ул. Калинина, дом 2, корпус 4, литера А.