

Automotive-grade N-Channel 40 V, 5.5 mΩ typ., 80 A STripFET™ F6 Power MOSFET in a D²PAK package

Datasheet - production data

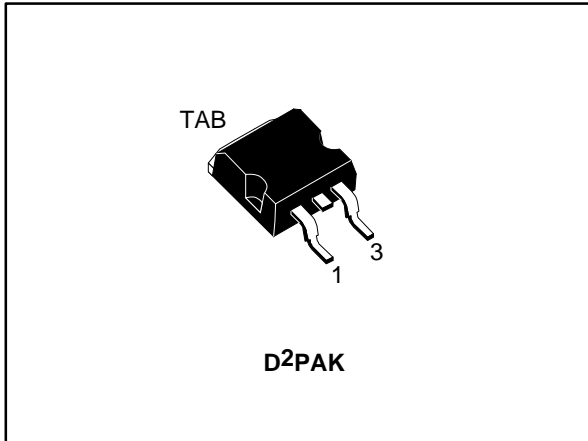
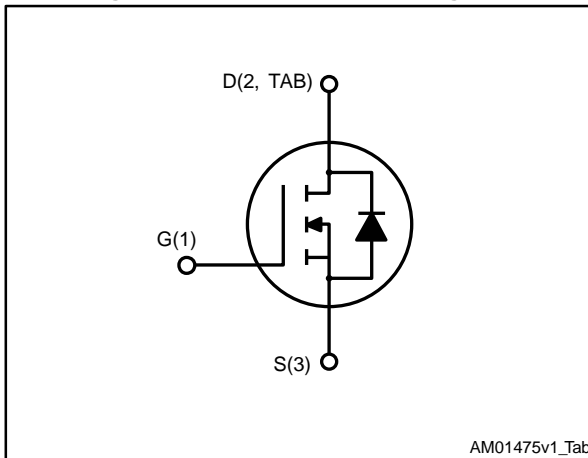

Figure 1: Internal schematic diagram



Features

Order code	V _{DS}	R _{DS(on)} max.	I _D
STB80N4F6AG	40 V	6 mΩ	80 A

- Designed for automotive applications and AEC-Q101 qualified
- Very low on-resistance
- Very low gate charge
- High avalanche ruggedness
- Low gate drive power loss

Applications

- Switching applications

Description

This device is an N-channel Power MOSFET developed using the STripFET™ F6 technology with a new trench gate structure. The resulting Power MOSFET exhibits very low R_{DS(on)} in all packages.

Table 1: Device summary

Order code	Marking	Package	Packaging
STB80N4F6AG	80N4F6	D ² PAK	Tape and Reel

Contents

- 1 Electrical ratings 3**
- 2 Electrical characteristics 4**
 - 2.1 Electrical characteristics (curves) 6
- 3 Test circuits 8**
- 4 Package mechanical data 9**
 - 4.1 D²PAK package information 9
 - 4.2 D²PAK packing information 12
- 5 Revision history 14**

1 Electrical ratings

Table 2: Absolute maximum ratings

Symbol	Parameter	Value	Unit
V _{DS}	Drain-source voltage	40	V
V _{GS}	Gate-source voltage	± 20	V
I _D	Drain current (continuous) at T _C = 25 °C	80	A
I _D	Drain current (continuous) at T _C = 100 °C	56	A
I _{DM} ⁽¹⁾	Drain current (pulsed)	320	A
P _{TOT}	Total dissipation at T _C = 25 °C	70	W
I _{AV}	Avalanche current, repetitive or not-repetitive (pulse width limited by T _J max)	40	A
E _{AS}	Single pulse avalanche energy(Starting T _J = 25 °C, = I _D = I _{AV} , V _{DD} = 25 V)	149	mJ
T _{stg}	Storage temperature	- 55 to 175	°C
T _j	Max. operating junction temperature	175	°C

Notes:

⁽¹⁾ Pulse width limited by safe operating area.

Table 3: Thermal data

Symbol	Parameter	Value	Unit
R _{thj-case}	Thermal resistance junction-case max.	2.14	°C/W
R _{thj-pcb} ⁽¹⁾	Thermal resistance junction-ambient max.	35	°C/W

Notes:

⁽¹⁾When mounted on FR-4 board of inch², 2 oz Cu

2 Electrical characteristics

($T_C = 25\text{ }^\circ\text{C}$ unless otherwise specified).

Table 4: On/Off States

Symbol	Parameter	Test conditions	Min.	Typ.	Max.	Unit
$V_{(BR)DSS}$	Drain-source breakdown voltage	$V_{GS} = 0\text{ V}$, $I_D = 250\text{ }\mu\text{A}$	40			V
I_{DSS}	Zero gate voltage drain current ($V_{GS} = 0\text{ V}$)	$V_{DS} = 40\text{ V}$			1	μA
		$V_{DS} = 40\text{ V}$ $T_J = 125\text{ }^\circ\text{C}$			100	μA
I_{GSS}	Gate-body leakage current ($V_{DS} = 0\text{ V}$)	$V_{GS} = \pm 20\text{ V}$			± 100	nA
$V_{GS(th)}$	Gate threshold voltage	$V_{DS} = V_{GS}$, $I_D = 250\text{ }\mu\text{A}$	2		4	V
$R_{DS(on)}$	Static drain-source on-resistance	$V_{GS} = 10\text{ V}$, $I_D = 40\text{ A}$		5.5	6	m Ω

Table 5: Dynamic

Symbol	Parameter	Test conditions	Min.	Typ.	Max.	Unit
C_{iss}	Input capacitance	$V_{DS} = 25\text{ V}$, $f = 1\text{ MHz}$, $V_{GS} = 0\text{ V}$	-	2150	-	pF
C_{oss}	Output capacitance		-	335	-	pF
C_{rss}	Reverse transfer capacitance		-	160	-	pF
Q_g	Total gate charge	$V_{DD} = 20\text{ V}$, $I_D = 80\text{ A}$, $V_{GS} = 10\text{ V}$ (see Figure 14: "Test circuit for gate charge behavior")	-	36	-	nC
Q_{gs}	Gate-source charge		-	11	-	nC
Q_{gd}	Gate-drain charge		-	9	-	nC

Table 6: Switching times

Symbol	Parameter	Test conditions	Min.	Typ.	Max.	Unit
$t_{d(on)}$	Turn-on delay time	$V_{DD} = 20\text{ V}$, $I_D = 40\text{ A}$, $R_G = 4.7\text{ }\Omega$, $V_{GS} = 10\text{ V}$ (see Figure 15: "Test circuit for inductive load switching and diode recovery times")	-	10.5	-	ns
t_r	Rise time		-	7.6	-	ns
$t_{d(off)}$	Turn-off-delay time		-	46.1	-	ns
t_f	Fall time		-	11.9	-	ns

Table 7: Source-drain diode

Symbol	Parameter	Test conditions	Min.	Typ.	Max.	Unit
I_{SD}	Source drain current				80	A
$I_{SDM}^{(1)}$	Source-drain current (pulsed)				320	A
$V_{SD}^{(2)}$	Forward on voltage	$I_{SD}= 40\text{ A}$, $V_{GS}= 0\text{ V}$			1.3	V
t_{rr}	Reverse recovery time	$I_{SD}= 80\text{ A}$, $di/dt = 100\text{ A}/\mu\text{s}$, $V_{DD}= 32\text{ V}$ (See Figure 17: "Unclamped inductive waveform")		41.1		ns
Q_{RR}	Reverse recovery charge			43.6		nC
I_{RRM}	Reverse recovery current			2.1		A

Notes:

(1)Pulse width limited by safe operating area.

(2)Pulsed: pulse duration = 300 μs , duty cycle 1.5%

2.1 Electrical characteristics (curves)

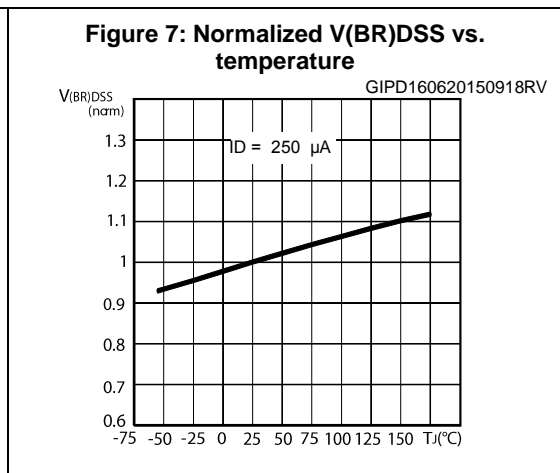
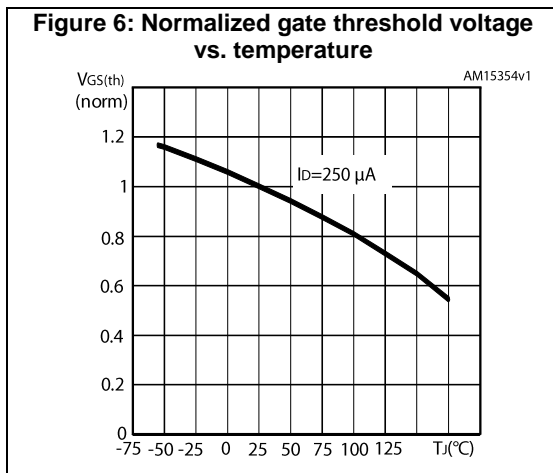
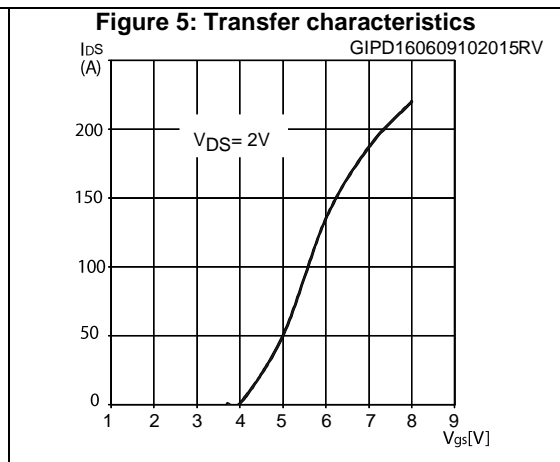
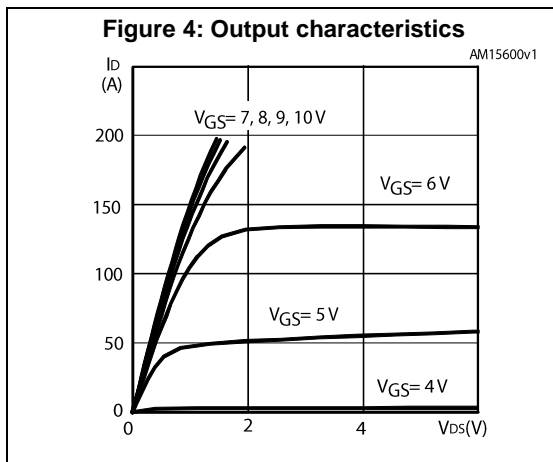
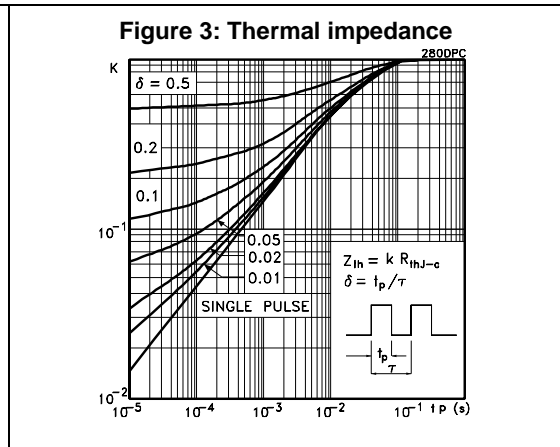
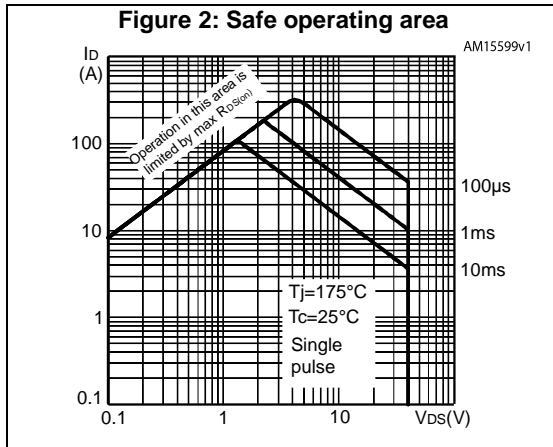

Figure 8: Static drain-source on-resistance

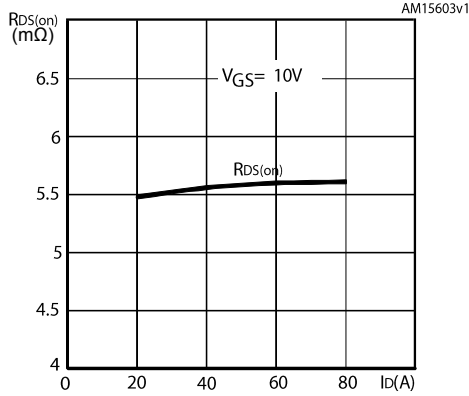

Figure 9: Normalized on-resistance vs. temperature

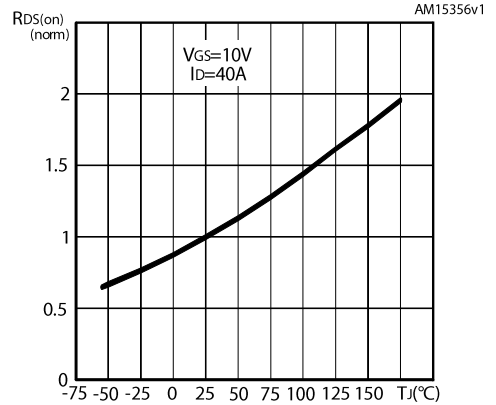

Figure 10: Gate charge vs. gate-source voltage

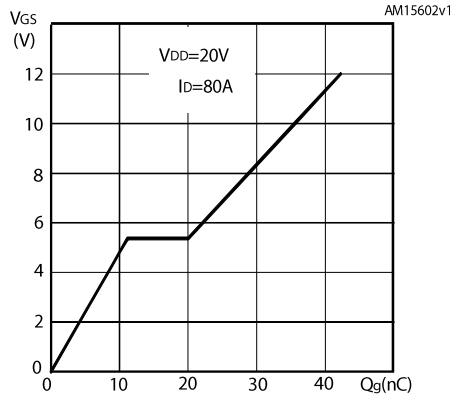

Figure 11: Capacitance variations

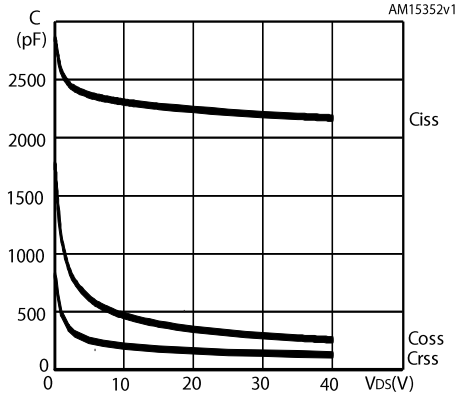
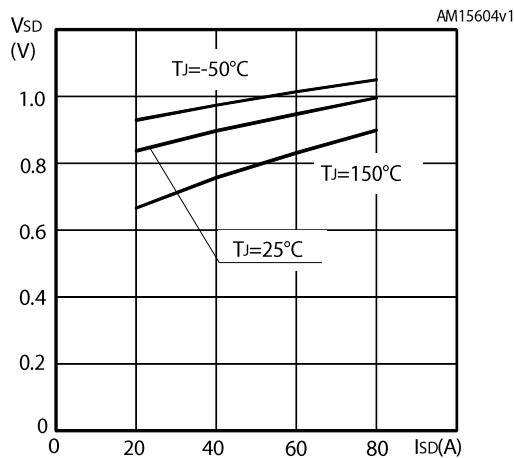
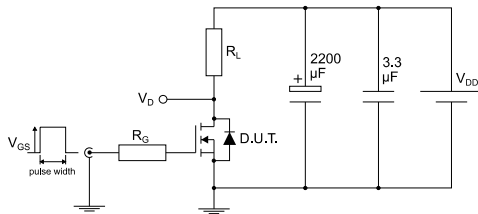

Figure 12: Source- drain diode forward characteristics



3 Test circuits

Figure 13: Test circuit for resistive load switching times



AM01468v1

Figure 14: Test circuit for gate charge behavior



AM01469v1

Figure 15: Test circuit for inductive load switching and diode recovery times

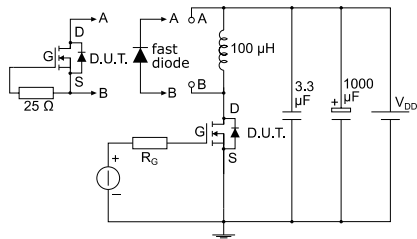

AM01470v1

Figure 16: Unclamped inductive load test circuit

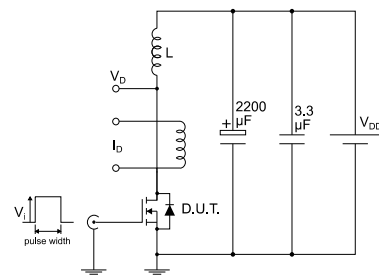

AM01471v1

Figure 17: Unclamped inductive waveform

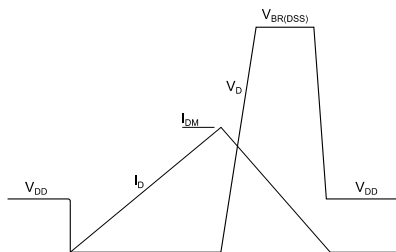

AM01472v1

Figure 18: Switching time waveform

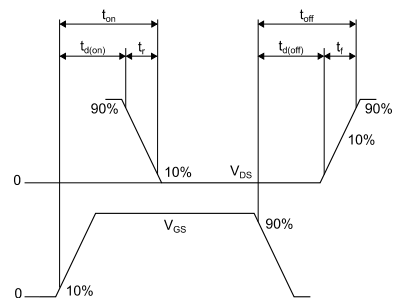

AM01473v1

4 Package mechanical data

In order to meet environmental requirements, ST offers these devices in different grades of ECOPACK® packages, depending on their level of environmental compliance. ECOPACK® specifications, grade definitions and product status are available at: www.st.com. ECOPACK® is an ST trademark.

4.1 D²PAK package information

Figure 19: D²PAK (TO-263) type A package outline

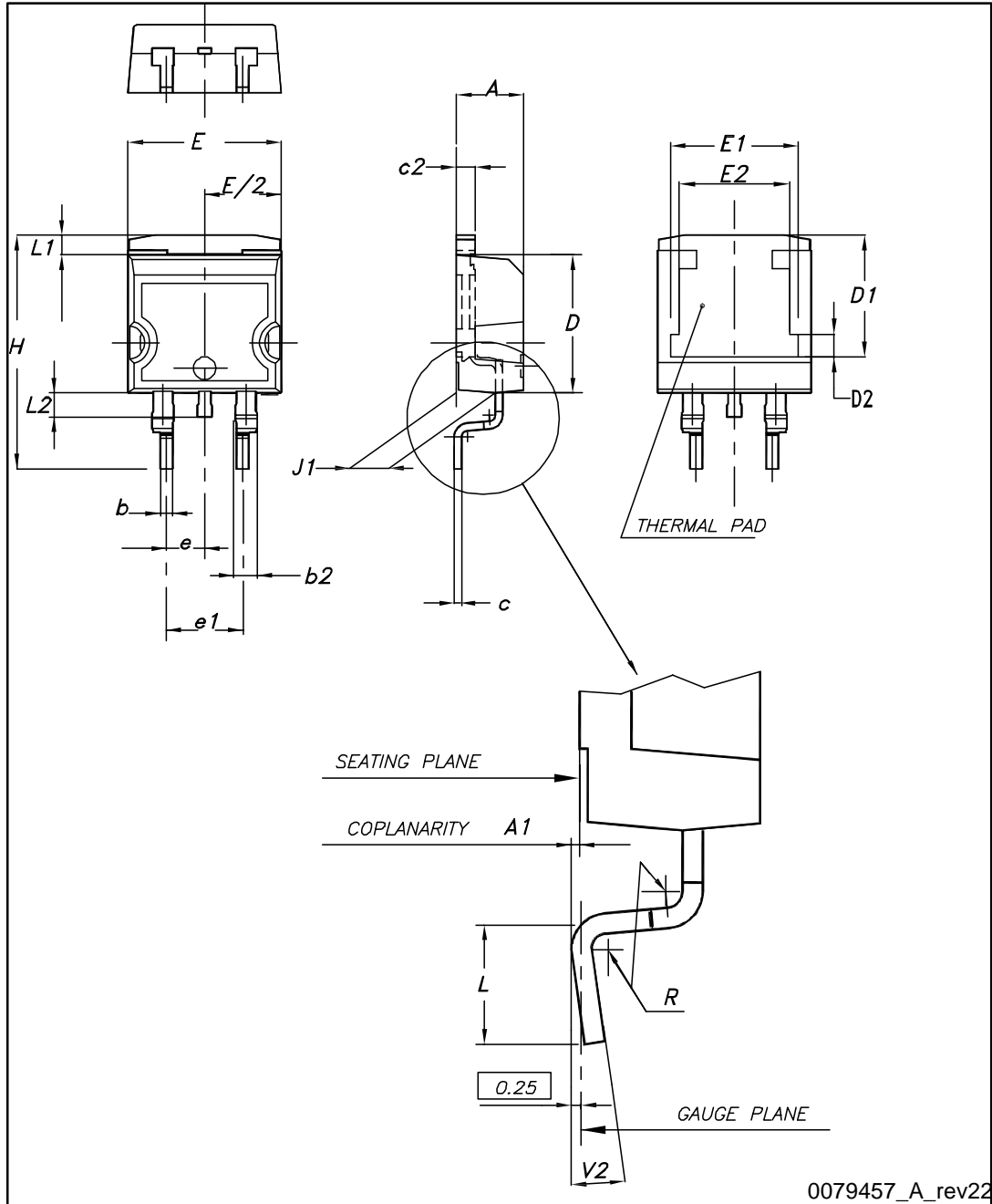
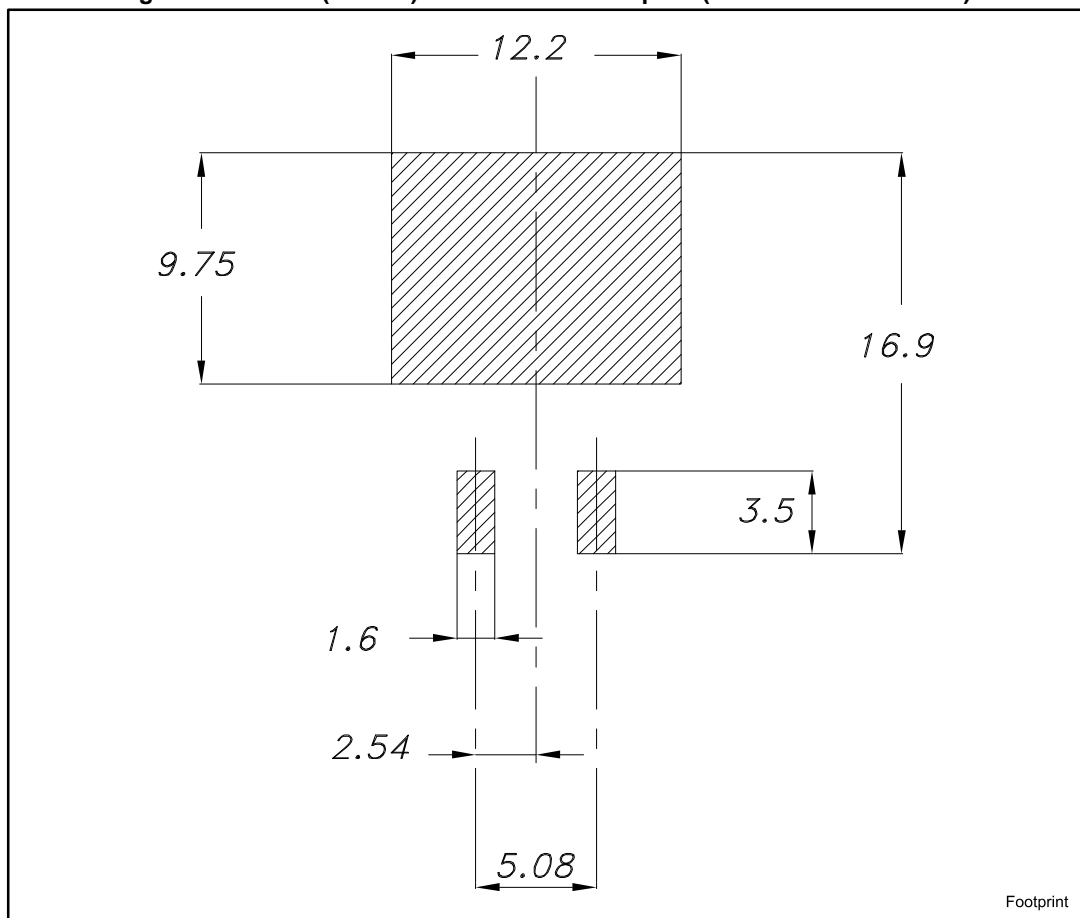

Table 8: D²PAK (TO-263) type A package mechanical data

Dim.	mm		
	Min.	Typ.	Max.
A	4.40		4.60
A1	0.03		0.23
b	0.70		0.93
b2	1.14		1.70
c	0.45		0.60
c2	1.23		1.36
D	8.95		9.35
D1	7.50	7.75	8.00
D2	1.10	1.30	1.50
E	10		10.40
E1	8.50	8.70	8.90
E2	6.85	7.05	7.25
e		2.54	
e1	4.88		5.28
H	15		15.85
J1	2.49		2.69
L	2.29		2.79
L1	1.27		1.40
L2	1.30		1.75
R		0.4	
V2	0°		8°

Figure 20: D²PAK (TO-263) recommended footprint (dimensions are in mm)



4.2 D²PAK packing information

Figure 21: Tape outline

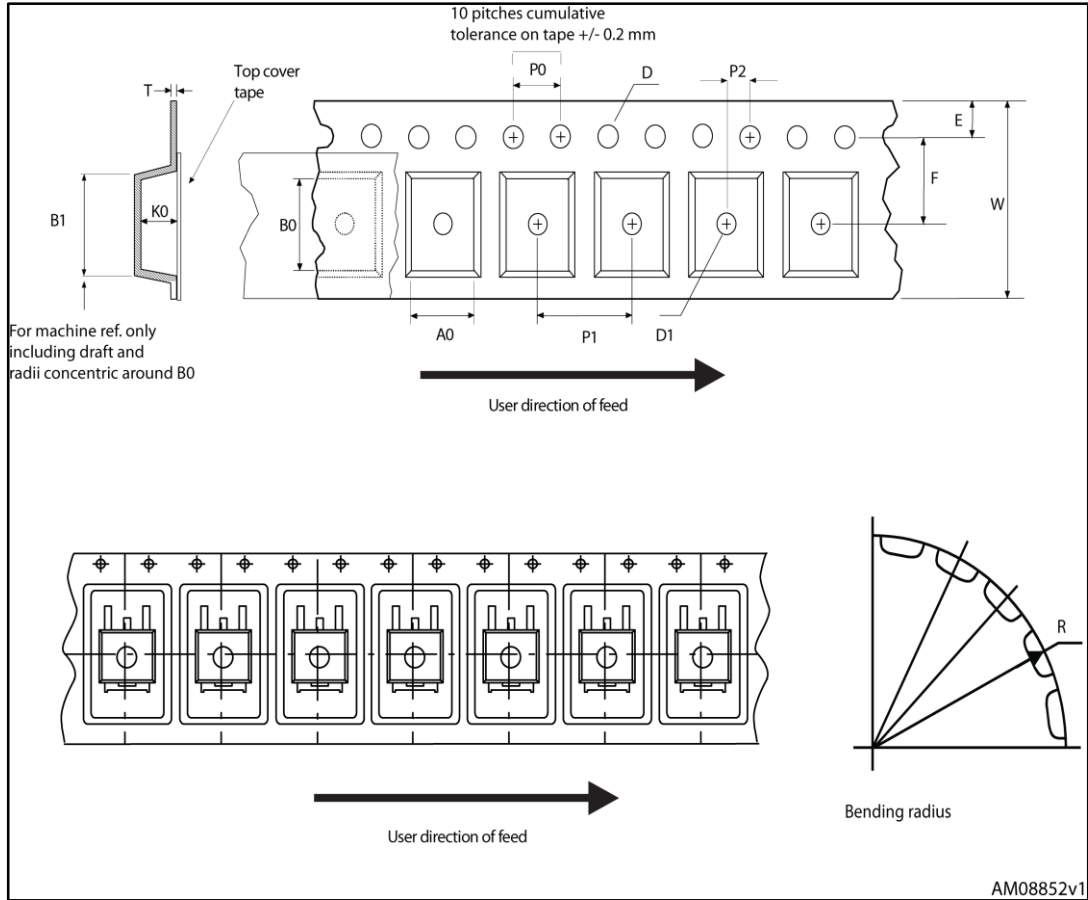

Figure 22: Reel outline

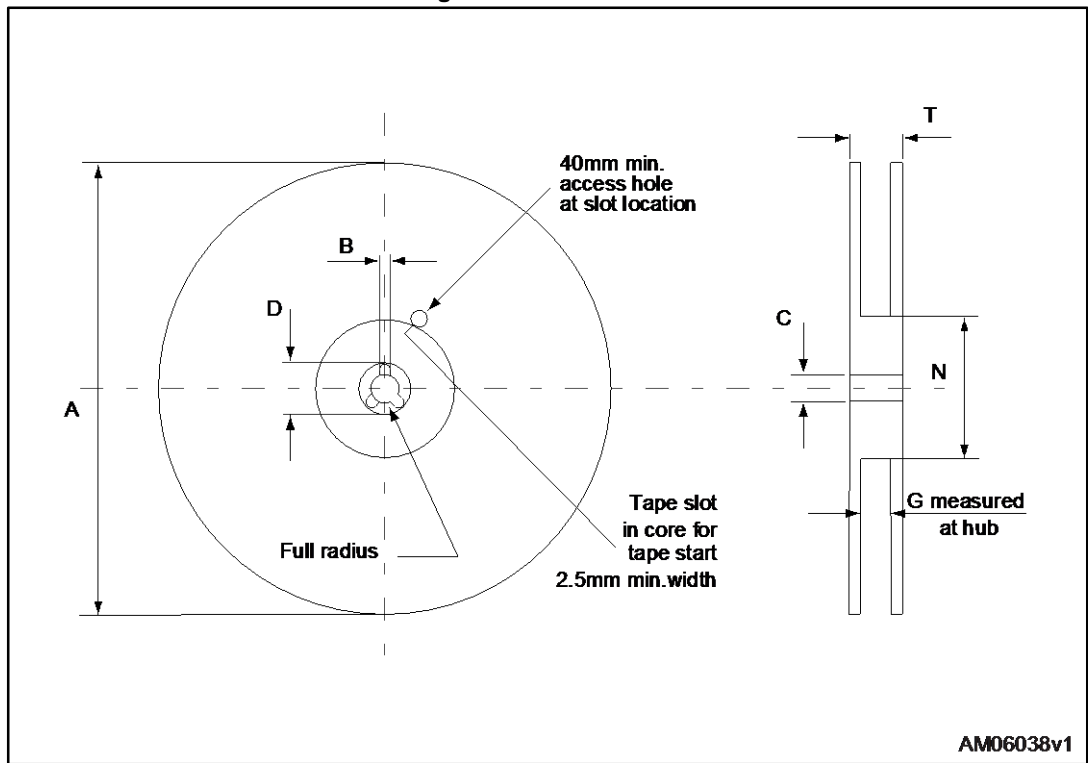

Table 9: D²PAK tape and reel mechanical data

Tape			Reel		
Dim.	mm		Dim.	mm	
	Min.	Max.		Min.	Max.
A0	10.5	10.7	A		330
B0	15.7	15.9	B	1.5	
D	1.5	1.6	C	12.8	13.2
D1	1.59	1.61	D	20.2	
E	1.65	1.85	G	24.4	26.4
F	11.4	11.6	N	100	
K0	4.8	5.0	T		30.4
P0	3.9	4.1			
P1	11.9	12.1	Base quantity		1000
P2	1.9	2.1	Bulk quantity		1000
R	50				
T	0.25	0.35			
W	23.7	24.3			

5 Revision history

Table 10: Document revision history

Date	Revision	Changes
16-Jun-2015	1	Initial release
18-Nov-2015	2	Document status promoted from preliminary to production data. Updated title and features in cover page.

IMPORTANT NOTICE – PLEASE READ CAREFULLY

STMicroelectronics NV and its subsidiaries ("ST") reserve the right to make changes, corrections, enhancements, modifications, and improvements to ST products and/or to this document at any time without notice. Purchasers should obtain the latest relevant information on ST products before placing orders. ST products are sold pursuant to ST's terms and conditions of sale in place at the time of order acknowledgement.

Purchasers are solely responsible for the choice, selection, and use of ST products and ST assumes no liability for application assistance or the design of Purchasers' products.

No license, express or implied, to any intellectual property right is granted by ST herein.

Resale of ST products with provisions different from the information set forth herein shall void any warranty granted by ST for such product.

ST and the ST logo are trademarks of ST. All other product or service names are the property of their respective owners.

Information in this document supersedes and replaces information previously supplied in any prior versions of this document.

© 2015 STMicroelectronics – All rights reserved



Компания «ЭлектроПласт» предлагает заключение долгосрочных отношений при поставках импортных электронных компонентов на взаимовыгодных условиях!

Наши преимущества:

- Оперативные поставки широкого спектра электронных компонентов отечественного и импортного производства напрямую от производителей и с крупнейших мировых складов;
- Поставка более 17-ти миллионов наименований электронных компонентов;
- Поставка сложных, дефицитных, либо снятых с производства позиций;
- Оперативные сроки поставки под заказ (от 5 рабочих дней);
- Экспресс доставка в любую точку России;
- Техническая поддержка проекта, помощь в подборе аналогов, поставка прототипов;
- Система менеджмента качества сертифицирована по Международному стандарту ISO 9001;
- Лицензия ФСБ на осуществление работ с использованием сведений, составляющих государственную тайну;
- Поставка специализированных компонентов (Xilinx, Altera, Analog Devices, Intersil, Interpoint, Microsemi, Aeroflex, Peregrine, Syfer, Eurofarad, Texas Instrument, Miteq, Cobham, E2V, MA-COM, Hittite, Mini-Circuits, General Dynamics и др.);

Помимо этого, одним из направлений компании «ЭлектроПласт» является направление «Источники питания». Мы предлагаем Вам помощь Конструкторского отдела:

- Подбор оптимального решения, техническое обоснование при выборе компонента;
- Подбор аналогов;
- Консультации по применению компонента;
- Поставка образцов и прототипов;
- Техническая поддержка проекта;
- Защита от снятия компонента с производства.



Как с нами связаться

Телефон: 8 (812) 309 58 32 (многоканальный)

Факс: 8 (812) 320-02-42

Электронная почта: org@eplast1.ru

Адрес: 198099, г. Санкт-Петербург, ул. Калинина, дом 2, корпус 4, литера А.