



3D SURROUND AUDIO PROCESSOR FOR HEADPHONE

■ GENERAL DESCRIPTION

The **NJM2703** is a high quality 3D surround audio processor designed for headphone applications.

It includes mode control switch (Surround mode / Bypass mode).

The **NJM2703** features low operating voltage, low operating current, low output noise and very small package, and is suitable for any portable audio applications.

■ PACKAGE OUTLINE



NJM2703RB2
(MSOP10 (TVSP10))

■ FEATURES

- Operating Voltage 1.8 to 6V
- Low Operating Current 0.45mA typ. (at Surround mode, VR: max.)
- Low Output Noise 10 μ V typ. (at Surround mode, VR: max.)
- Variable Surround Effect by external resistor
- Internal Mode Control Switch
- Bipolar Technology
- Package Outline MSOP10 (TVSP10)*

*MEET JEDEC MO-187-DA / THIN TYPE

■ PIN CONFIGURATION

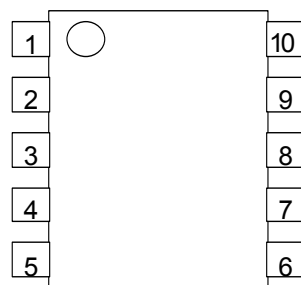

1. LIN
2. RIN
3. SW
4. VREF
5. GND
6. V+
7. NFR
8. NFL
9. ROUT
10. LOUT

■ BLOCK DIAGRAM

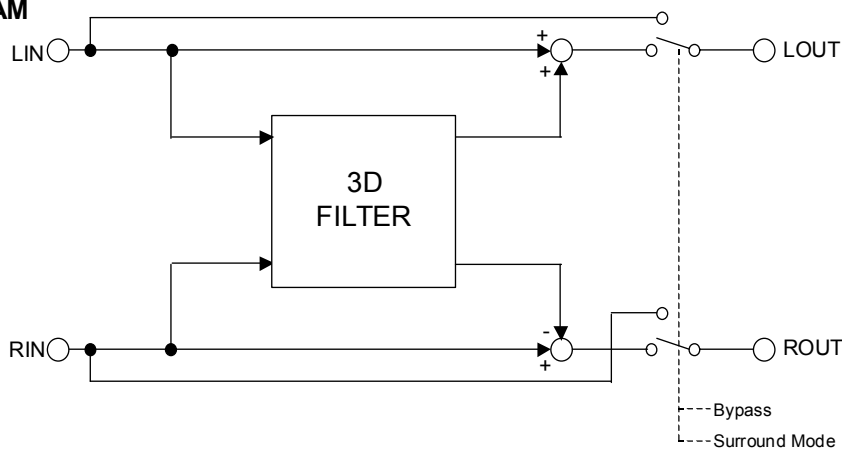

NJM2703

■ABSOLUTE MAXIMUM RATING (Ta=25°C)

PARAMETER	SYMBOL	RATINGS	UNIT
Supply Voltage	V ⁺	7	V
Power Dissipation	P _D	320	mW
Operating Temperature Range	T _{opr}	-20 to +75	°C
Storage Temperature Range	T _{stg}	-40 to +125	°C

■OPERATING VOLTAGE

PARAMETER	SYMBOL	TEST CONDITION	MIN.	TYP.	MAX.	UNIT
Operating Voltage	V ⁺	-	1.8	3.0	6.0	V

■ELECTRICAL CHARACTERISTICS (V⁺=3V, Ta=25°C unless otherwise specified)

PARAMETER	SYMBOL	TEST CONDITION						MIN.	TYP.	MAX.	UNIT
		INPUT		OUTPUT	MODE	VR					
		L	R								
Operating Current	I _{cc}	No Signal	0	0	-	Bypass	-	-	0.45	0.7	mA
			0	0	-	Surround	MAX	-	0.45	0.7	
Reference Voltage	V _{ref}	No Signal	0	0	-	-	-	1.0	1.15	1.3	V

● AC CHARACTERISTICS

(V⁺=3V, Ta=25°C, V_{IN}=-20dBV(100mVrms), f=1kHz, R_L=10kΩ, unless otherwise specified)

PARAMETER	SYMBOL	TEST CONDITION						MIN.	TYP.	MAX.	UNIT
		INPUT		OUTPUT	MODE	VR					
		L	R								
Maximum Input Voltage	V _{IM}	f=1kHz T.H.D.=1%	V _{IN} 0	0 V _{IN}	L R	Bypass	-	-	-2.0 (790)	-	dBV (mVrms)
		f=100Hz T.H.D.=1%	V _{IN} 0	0 V _{IN}	L R	Surround	MAX	-	-16.0 (160)	-	
		V ⁺ =1.8V f=1kHz T.H.D.=1%	V _{IN} 0	0 V _{IN}	L R	Bypass	-	-10.5 (300)	-8.5 (380)	-	
		V ⁺ =1.8V f=100Hz T.H.D.=1%	V _{IN} 0	0 V _{IN}	L R	Surround	MAX	-24.5 (60)	-22.5 (75)	-	
Output Noise	V _{NO}	R _g =0Ω A-Weighted	0	0	L R	Bypass	-	-	-112 (2.5)	-106 (5.0)	dBV (μVrms)
		R _g =0Ω A-Weighted	0	0	L R	Surround	MAX	-	-100 (10)	-94 (20)	
Total Harmonic Distortion	T.H.D.	f=1kHz	V _{IN} 0	0 V _{IN}	L R	Bypass	-	-	0.02	0.05	%
		f=1kHz	V _{IN} 0	0 V _{IN}	L R	Surround	MAX	-	0.1	0.5	

● **AC CHARACTERISTICS**

($V^+=3V$, $T_a=25^\circ C$, $V_{IN}=-20dBV(100mV_{rms})$, $f=1kHz$, $R_L=10k\Omega$, unless otherwise specified)

PARAMETER	SYMBOL	TEST CONDITION						MIN.	TYP.	MAX.	UNIT
		INPUT		OUTPUT	MODE	VR					
		L	R								
Bypass Gain	G_{VBYP}	$f=1kHz$	V_{IN} 0	0 V_{IN}	L R	Bypass	-	-1.0	0.0	1.0	dB
Surround Gain	G_{VSUR}	$f=100Hz$	V_{IN} 0	0 V_{IN}	L R	Surround	MAX	12.5	14.5	16.5	dB
		$f=100Hz$	0 V_{IN}	V_{IN} 0	L R	Surround	MAX	10.5	12.5	14.5	
		$f=100Hz$	V_{IN} 0	0 V_{IN}	L R	Surround	MIN	0.5	2.5	4.5	

● **CONTROL CHARACTERISTICS** ($V^+=3V$, $T_a=25^\circ C$ unless otherwise specified)

PARAMETER	SYMBOL	TEST CONDITION						MIN.	TYP.	MAX.	UNIT
		INPUT		OUTPUT	MODE	VR					
		L	R								
Mode Select Control Voltage	V_{MODE}	$V_{IN}=$ High Level	-	-	-	-	-	1.2	-	V^+	V
		$V_{IN}=$ Low Level	-	-	-	-	-	0.0	-	0.3	

■ **MODE SWITCH**

MODE	SW	NOTES
Bypass	L, open	Input Through
Surround	H	Surround Mode (Stereo Input)

NJM2703

■ TERMINAL DESCRIPTION

PIN NO.	SYMBOL	FUNCTION	EQUIVALENT CIRCUIT	VOLTAGE
1 2	LIN RIN	Rch Input Lch Input		1.15V
3	SW	Mode control switch		0V
4	VREF	Reference voltage		1.15V
5	GND	GND		0V

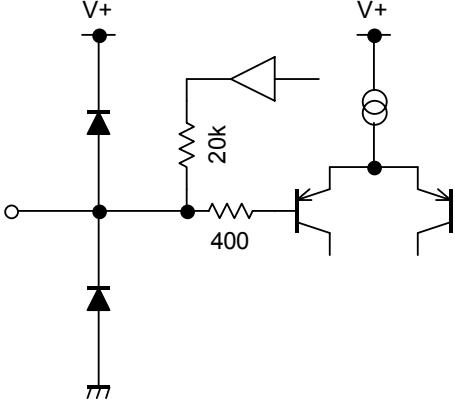
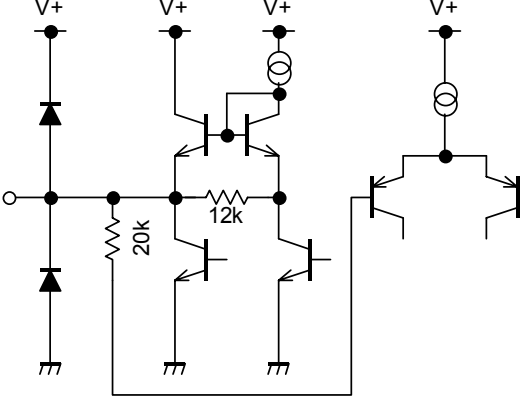
PIN NO.	SYMBOL	FUNCTION	EQUIVALENT CIRCUIT	VOLTAGE
5	V+	Power Supply		V+
7 8	NFL NFR	Filter terminal Filter terminal		1.15V
9 10	ROUT LOUT	Rch Output Lch Output		1.15V

NJM2703

■ APPLICATION CIRCUIT

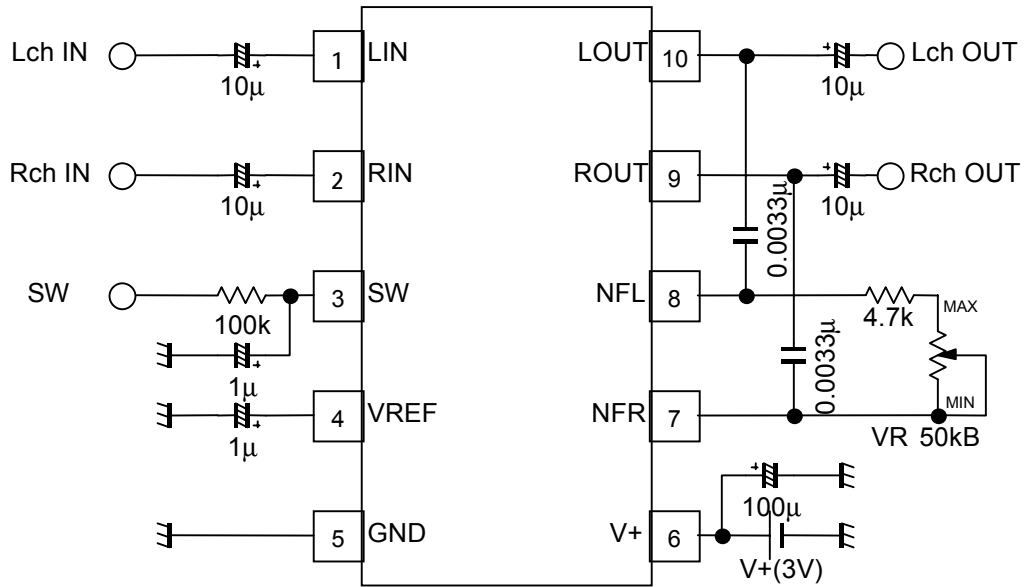

■ TYPICAL CHARACTERISTICS

Supply Current vs. Supply Voltage

Ta=25degrees

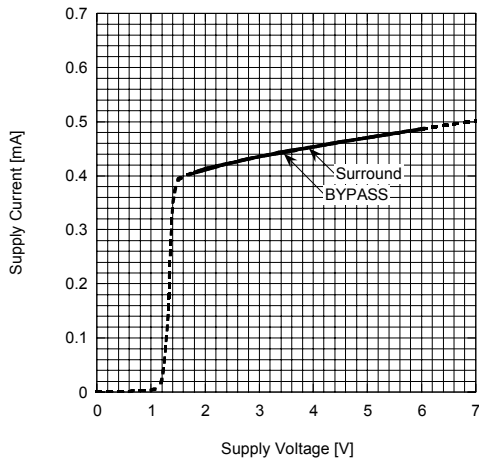

Supply Current vs. Ambient Temperature

V+=3V

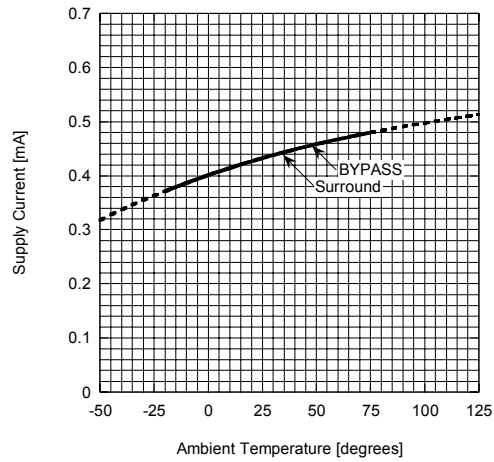

Reference Voltage vs. Supply Voltage

Ta=25degrees

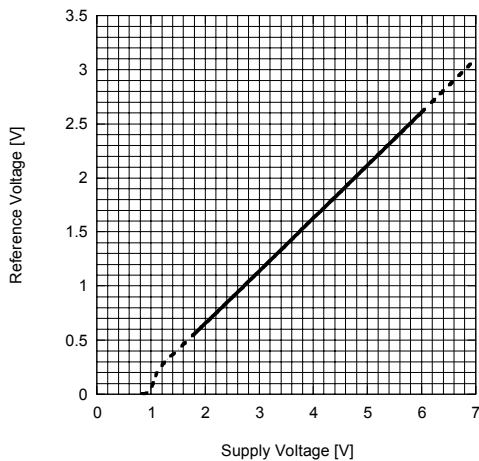

Reference Voltage vs. Ambient Temperature

V+=3V

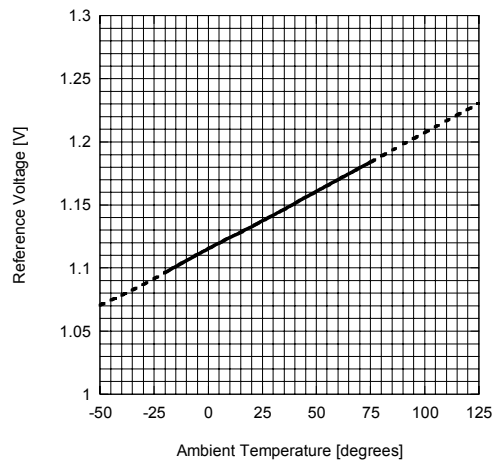

Maximum Input Voltage vs. Supply Voltage (BYPASS)

Vin=Lch f=1kHz Vout=Lch RL=10kohm
THD=1% Ta=25degrees

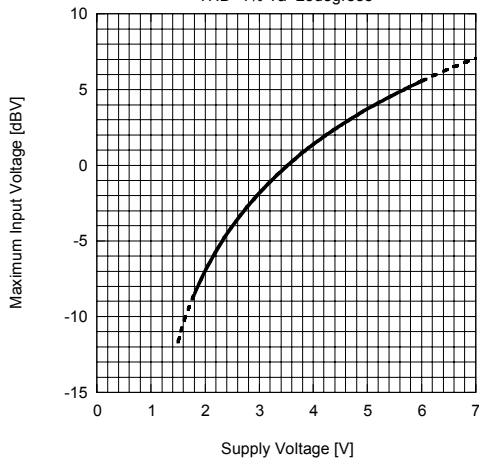

Maximum Input Voltage vs. Supply Voltage (Surround)

Vin=Lch f=100Hz Vout=Lch RL=10kohm VR=MAX
THD=1% Ta=25degrees

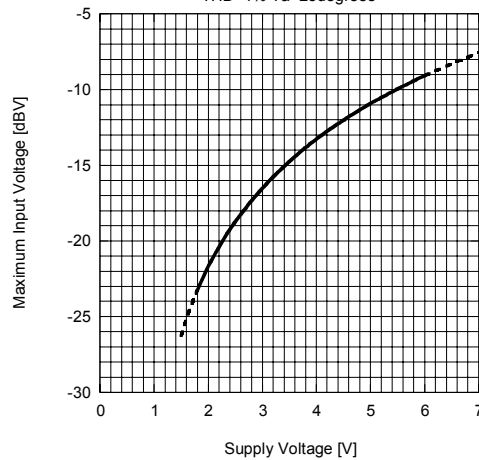

TYPICAL CHARACTERISTICS

Maximum Input Voltage vs. Ambient Temperature (BYPASS)

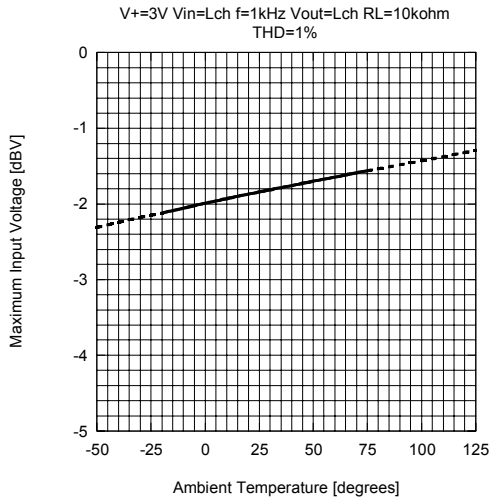

Maximum Input Voltage vs. Ambient Temperature (Surround)

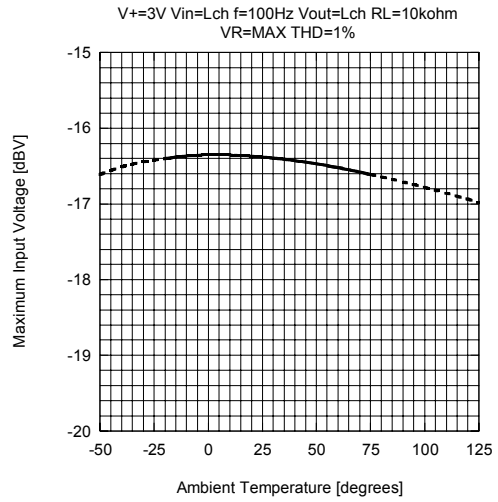

Maximum Input Voltage vs. Ambient Temperature (BYPASS)

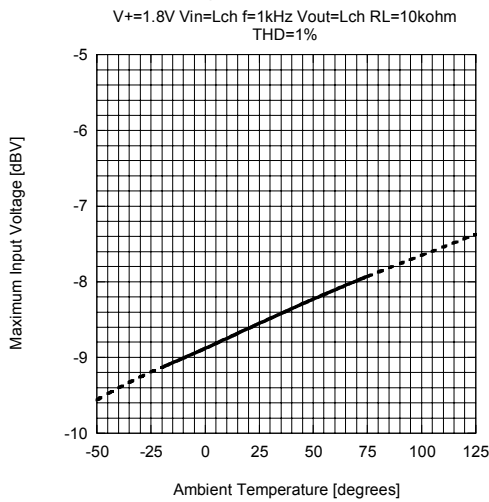

Maximum Input Voltage vs. Ambient Temperature (Surround)

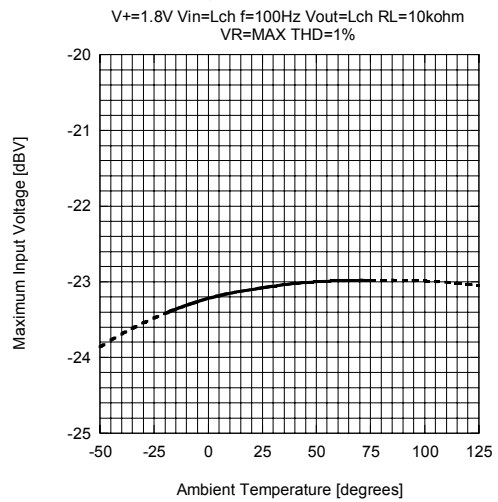

Output Noise Voltage vs. Ambient Temperature

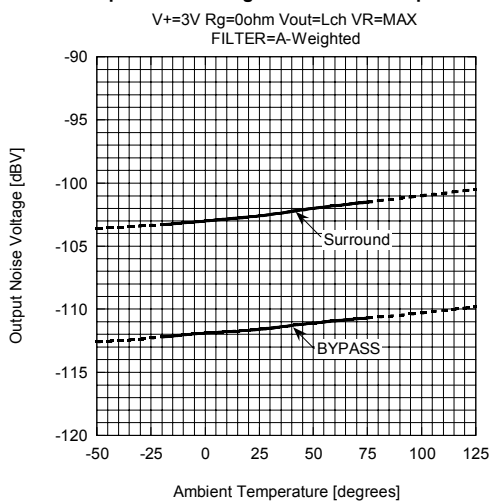

Output Noise Voltage vs. Ambient Temperature

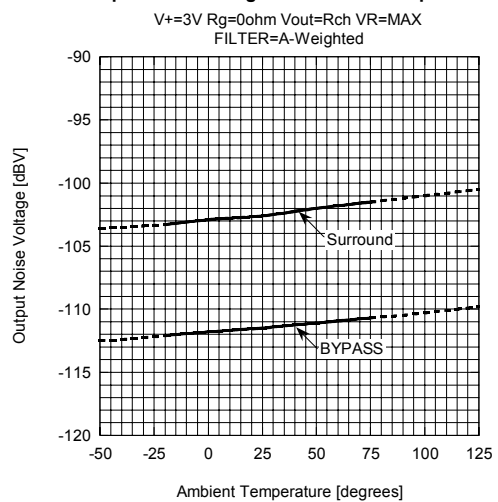

TYPICAL CHARACTERISTICS

Total Harmonic Distortion vs. Input Voltage (BYPASS)

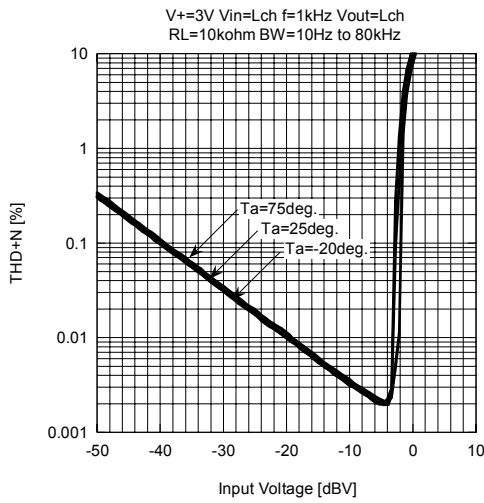

Total Harmonic Distortion vs. Input Voltage (Surround)

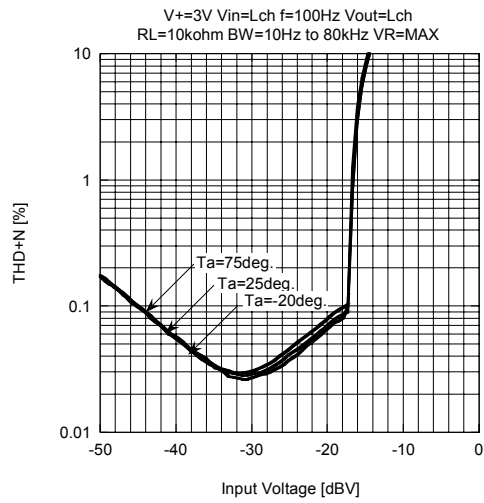

Voltage Gain vs. Frequency (BYPASS)

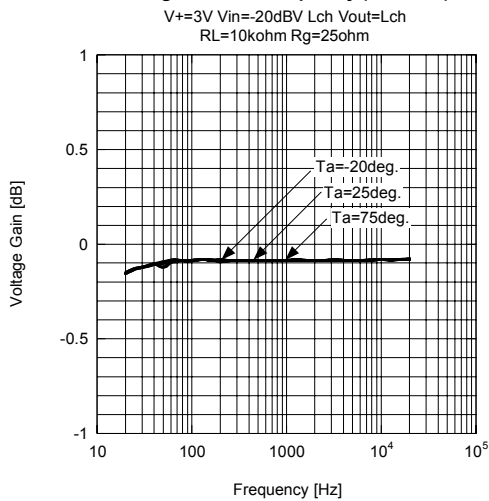

Voltage Gain vs. Frequency (Surround)

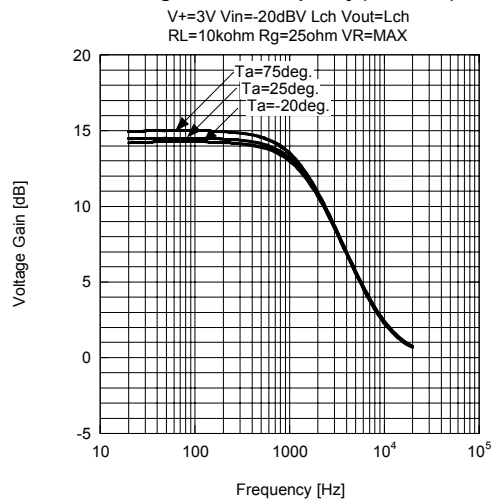

Voltage Gain vs. Frequency (Surround)

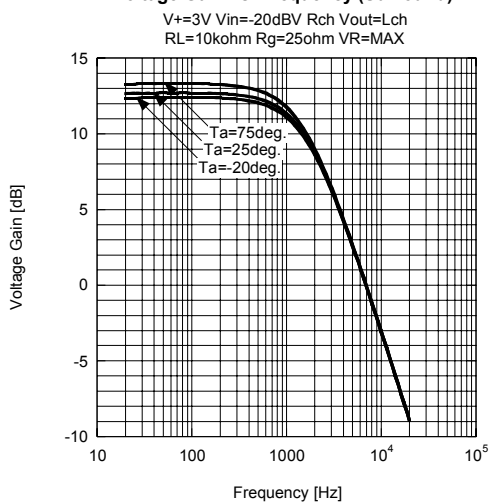

Voltage Gain vs. Frequency (Surround)

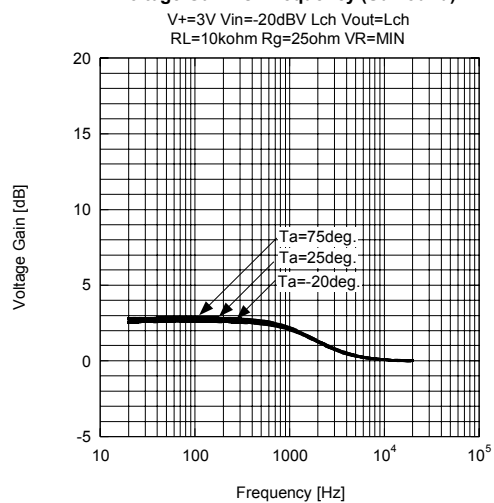

■ TYPICAL CHARACTERISTICS

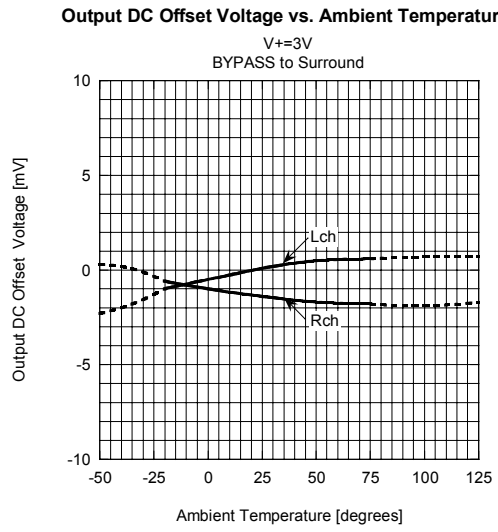
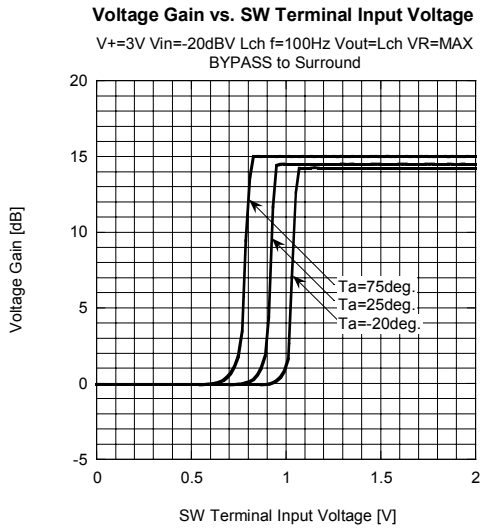

[CAUTION]
 The specifications on this databook are only given for information, without any guarantee as regards either mistakes or omissions. The application circuits in this databook are described only to show representative usages of the product and not intended for the guarantee or permission of any right including the industrial rights.

Mouser Electronics

Authorized Distributor

Click to View Pricing, Inventory, Delivery & Lifecycle Information:

[NJR:](#)

[NJM2703RB2-TE1](#)



Компания «ЭлектроПласт» предлагает заключение долгосрочных отношений при поставках импортных электронных компонентов на взаимовыгодных условиях!

Наши преимущества:

- Оперативные поставки широкого спектра электронных компонентов отечественного и импортного производства напрямую от производителей и с крупнейших мировых складов;
- Поставка более 17-ти миллионов наименований электронных компонентов;
- Поставка сложных, дефицитных, либо снятых с производства позиций;
- Оперативные сроки поставки под заказ (от 5 рабочих дней);
- Экспресс доставка в любую точку России;
- Техническая поддержка проекта, помощь в подборе аналогов, поставка прототипов;
- Система менеджмента качества сертифицирована по Международному стандарту ISO 9001;
- Лицензия ФСБ на осуществление работ с использованием сведений, составляющих государственную тайну;
- Поставка специализированных компонентов (Xilinx, Altera, Analog Devices, Intersil, Interpoint, Microsemi, Aeroflex, Peregrine, Syfer, Eurofarad, Texas Instrument, Miteq, Cobham, E2V, MA-COM, Hittite, Mini-Circuits, General Dynamics и др.);

Помимо этого, одним из направлений компании «ЭлектроПласт» является направление «Источники питания». Мы предлагаем Вам помощь Конструкторского отдела:

- Подбор оптимального решения, техническое обоснование при выборе компонента;
- Подбор аналогов;
- Консультации по применению компонента;
- Поставка образцов и прототипов;
- Техническая поддержка проекта;
- Защита от снятия компонента с производства.



Как с нами связаться

Телефон: 8 (812) 309 58 32 (многоканальный)

Факс: 8 (812) 320-02-42

Электронная почта: org@eplast1.ru

Адрес: 198099, г. Санкт-Петербург, ул. Калинина, дом 2, корпус 4, литера А.