



Transformers for Switching Power Supplies

Pin terminal type (For multiple outputs)

ECO series

ECO20 (Vertical/Horizontal types)

ECO22 (Vertical/Horizontal types)

ECO24 (Vertical/Horizontal types)

An attention matter on use

Please read this specifications before using this product by all means.

An attention matter on security

I undertake use with this product, and it is paid attention enough, and please design an attention matter safely.

Attention on a design

- When you designs a base of an electric circuit.
Please use size of the hole or pad which we recommend.
- Magnetic flux to leak out occurs. Please confirm it about influence of magnetic flux beforehand.
There is fear to cause false movement of machinery.
- In a design of a base of an electric circuit, Please consider the next contents.
In an applied safe standard.
The trans and distance with other parts
- The product is not quakeproof structure.
Accordingly please do not add vibration and a shock to it.
There is fear to lose a function.

Attention on the handling

- Please do not use it when you let a product drop.
The product produces possibility to lose a function
- Please pay attention to the pin which had it pointed keenly.
There is danger to injure.
- Please avoid the next place. The place that receives a drop of water, trash, the dust, foggy influence. The place where direct rays of the sun hits. There is fear to cause false movement of machinery.
- Please prohibit safekeeping and use at the next place. Environment to be accompanied with gas corrosion, salt, acid, alkali. There is fear to lose a function.
- When you carry the product on a base of an electric circuit.
Please do not use a metal tool. Because impossible power is added to a product.
There is fear to lose a function.

Attention

- I considered the next matter, and we designed a product.
Safe standard and power supply voltage and circuit drive condition, drive frequency and Duty ON-TIME.
By those conditions, we decided structure and the turns number.
Please avoid use in designed condition outside.
There are destruction of a circuit part and fear of ignition.
- This product considered a characteristic of a component and a self temperature rise, and it was made.
We select range of humidity as use temperature already.
Please avoid use by range more than this.
There are the damage and fear of ignition.
- Please avoid use in the environment next.
The environment that trash and the dust stick to a product. There is fear to cause a fire.
- The products listed on this specification sheet are intended for use in general electronic equipment (AV equipment, telecommunications equipment, home appliances, amusement equipment, computer equipment, personal equipment, office equipment, measurement equipment, industrial robots) under a normal operation and use condition.
- The products are not designed or warranted to meet the requirements of the applications listed below, whose performance and/or quality require a more stringent level of safety or reliability, or whose failure, malfunction or trouble could cause serious damage to society, person or property.
- If you intend to use the products in the applications listed below or if you have special requirements exceeding the range or conditions set forth in this catalog, please contact us.

- (1) Aerospace/Aviation equipment
- (2) Transportation equipment (cars, electric trains, ships, etc.)
- (3) Medical equipment
- (4) Power-generation control equipment
- (5) Atomic energy-related equipment
- (6) Seabed equipment applications
- (7) Transportation control equipment

- (8) Public information-processing equipment
- (9) Military equipment
- (10) Electric heating apparatus, burning equipment
- (11) Disaster prevention/crime prevention equipment
- (12) Safety equipment
- (13) Other applications that are not considered general-purpose applications

When designing your equipment even for general-purpose applications, you are kindly requested to take into consideration securing protection circuit/device or providing backup circuits in your equipment.

Transformers for Switching Power Supplies

ECO series

Contents	Page
Development Concept	4
Overview	5
Product Lineup.....	7
ECO20 series For multiple outputs (Vertical/Horizontal types)	9
ECO22 series For multiple outputs (Vertical/Horizontal types)	12
ECO24 series For multiple outputs (Vertical/Horizontal types)	17
List of Plans for Standard Windings and Connections.....	26
Design Reference for Switching Power Transformers.....	30

• All specifications are subject to change without notice.

Transformers for Switching Power Supplies

Product compatible with RoHS directive
Compatible with lead-free solders

Pin terminal type (For multiple outputs)

Development Concept of the ECO Series

The ECO series is compliant with worldwide safety standards*. It is a pin-compatible, newly developed transformer that can be downsized and thinned.

* Applicable as of April 2007: UL/IEC/J 60065 Ver.7 (TV, DVD, STB), UL/IEC/60950 Ver.3 (printer), UL/IEC 60335-1 Ver.4 (home appliance)

■ MATERIAL

Optimum materials and core shape have been developed. No insulation-supporting material is used, and this secures the insulating distance.

While optimizing materials, TDK has further improved its proprietary core shape to develop a new-type ECO core. TDK has downsized the product considerably in order to securing the necessary creepage distance.

■ MANUFACTURING METHOD

Since the ECO Series supports automatic winding, the product is of a high quality and can be manufactured stably.

It is designed to support automatic winding, which enables a remarkable reduction in the loss generated to achieve a proficient in manual winding until stable production.

■ OPTIMIZATION DESIGN

Using design tools developed with TDK's comprehensive know-how, high-precision design has been achieved in a short period of time.

- 1) For optimization design and high-quality stable production, customers can use a specification request form.
- 2) If you provide the necessary information in the form, you will receive the optimization design in a short time.
- 3) We have prepared an individual specifications request document for the home appliance market.
- 4) TDK recommends design with a standard core gap (AL-value) for optimization and shorter trial and mass production lead time. Plans for standard winding connection (patterns of recommended pin arrangement and winding structure) are available. These help to speed up the design process, support automatic winding, and prevent deterioration in quality.

■ ENVIRONMENT

The ECO series is RoHS directive-compliant.

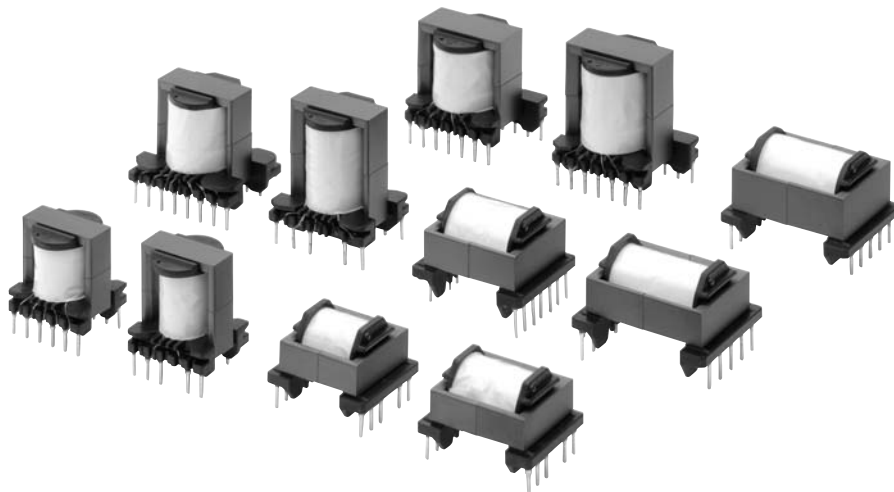

Transformers for Switching Power Supplies

Product compatible with RoHS directive
Compatible with lead-free solders

Pin terminal type (For multiple outputs)

Overview of the ECO Series

FEATURES

- Downsized yet compliant with worldwide safety standards.
- Supports automatic winding.
- Considerably reduced characteristic variations.
- Product compatible with RoHS directive.

APPLICATION

- Set-top boxes, air-conditioners, DVD players/recorders
- Blu-ray disc players/recorders, printers, LCD monitors
- Multiple-output power supplies

PART NUMBER CONSTRUCTION



OPERATING TEMPERATURE RANGE, PACKAGE QUANTITY, PRODUCT WEIGHT

Type	Temperature range		Humidity range		Standard test conditions	
	Operating temperature*	Storage temperature	Operating humidity range**	Storage humidity range**	Ambient temperature	Relative humidity range***
	(°C)	(°C)	(%RH)	(%RH)	(°C)	(%RH)
ECO2017	-30 to +120	-40 to +80	10 to 95	10 to 95	25 ± 10	25 to 75
ECO2020	-30 to +120	-40 to +80	10 to 95	10 to 95	25 ± 10	25 to 75
ECO2023	-30 to +120	-40 to +80	10 to 95	10 to 95	25 ± 10	25 to 75
ECO2219	-30 to +120	-40 to +80	10 to 95	10 to 95	25 ± 10	25 to 75
ECO2225	-30 to +120	-40 to +80	10 to 95	10 to 95	25 ± 10	25 to 75
ECO2230	-30 to +120	-40 to +80	10 to 95	10 to 95	25 ± 10	25 to 75
ECO2420	-30 to +120	-40 to +80	10 to 95	10 to 95	25 ± 10	25 to 75
ECO2425	-30 to +120	-40 to +80	10 to 95	10 to 95	25 ± 10	25 to 75
ECO2430	-30 to +120	-40 to +80	10 to 95	10 to 95	25 ± 10	25 to 75

* With self-heating

** Maximum wet-bulb temperature 38°C, without dewing

***Without dewing

RoHS Directive Compliant Product: See the following for more details.<https://product.tdk.com/info/en/environment/rohs/index.html>

 Please be sure to request delivery specifications that provide further details on the features and specifications of the products for proper and safe use.
Please note that the contents may change without any prior notice due to reasons such as upgrading.

Overview of the ECO Series

■ GENERAL CHARACTERISTICS

Item	Standards	Test methods
Inductance	Individual specification (tolerance \pm 10%)	Use LCR meter (f=10kHz), 4263B or equivalent.
DC resistance	Less than 0.1 Ω : \pm 30% 0.1 Ω to 1.0 Ω : \pm 20% 1.0 Ω or more: \pm 15%	Use Ohm-meter AX114N or equivalent.
Turn ratio and polarity	Specified value \pm 1 to 20%, individual specification	Use turn ratio tester TRM-201 (f=1 to 100kHz) or equivalent.
Withstand voltage	No abnormality between the primary and secondary windings, between the primary winding and the core, and so on.	Apply separately specified AC voltage (50Hz) for 1min.
Insulation resistance	100M Ω min.	Measure by applying DC.500V. Use insulation resistance meter SM-5E or equivalent.
Temperature rise	Standard design value 45°C max. (thermocouple method) 55°C max. (resistance method)	Measure the core surface by thermocouple method, and the windings by resistance method or thermocouple method.

■ RELIABILITY TESTS

Item	Standards	Test methods
Vibration resistance		Sweep 1.5mm amplitude and 10-to-55-to-10Hz in 1min in X, Y, and Z directions for 2h respectively.
Heat resistance	Standard of inductance, insulation resistance, withstand voltage must be satisfied.	Measure in normal temperature after leaving in 100 \pm 2°C for 96h.
Cold resistance		Measure in normal temperature after leaving in -40 \pm 2°C for 96h.
Humidity resistance		Measure in normal temperature after leaving in 60 \pm 2°C and 90 to 95(%)RH for 96h.
Temperature cycle		One cycle is -25°C for 30min, normal temperature for 30min, and 85°C for 30min; measure after 10 cycles of the test have been performed.
Terminal strength	9.8N min.	Apply 9.8N load in the direction of terminal axis for 30 \pm 5s. Any terminal must not be pulled out or chatter.
Solderability	Solder covers more than 90%.	Dip in solder with the temperature of 245 \pm 2°C for 3 \pm 0.5s.

● The above listed items are representative examples.

The details can be found by referring to the appended individual delivery specifications.

Product Lineup

We have made a new lineup of replacement parts for products with different shapes that meet our customers' needs for smaller products. We can also provide different transformer shapes not shown in the catalog, so feel free to contact us.

Vertical type



Horizontal type

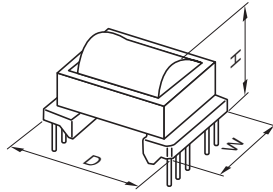

Product Lineup

New shaped*1	Core parameter				Bobbin parameter				Dimensions		
	General-purpose shaped cores	Cross-sectional center leg area Ae (mm ²)	Reference output power*2 (W)	Switching Frequency fsw(kHz)	Bobbin Type*3	Terminal		Number of pins	Depth	Width	Height
						Pin pitch P (mm)	Lead space F (mm)		D ×	W ×	H
Vertical type											
ECO2017	EI22	36.3	12	50	VI	3.75	15.0	12	19.5	22.5	24.0
ECO2020	EE25/19		20		VI				19.5	22.5	27.0
ECO2023			26		VI				19.5	22.5	30.0
ECO2219		46.4	25	50	VI	5.0	17.5	12	23.0	28.5	25.0
					VII	4.0	17.5	12	23.0	24.0	25.0
					VIII	3.75	17.5	14	23.0	30.0	25.0
ECO2225	EED2820 EER28	46.4	36	50	VI	5.0	17.5	12	23.0	28.5	31.0
					VII	4.0	17.5	12	23.0	28.5	31.0
					VIII	3.75	17.5	14	23.0	30.0	31.0
ECO2230		46.4	48	50	VI	5.0	17.5	12	23.0	28.5	36.0
					VII	4.0	17.5	12	23.0	24.0	36.0
ECO2420		63.8	35	50	VI	5.0	17.5	12	24.0	28.5	26.5
					VII	4.0	20.0	14	25.0	31.5	26.5
ECO2425	EER28L	63.8	50	50	VI	5.0	17.5	12	24.0	28.5	31.5
					VII	4.0	20.0	16	25.0	35.5	31.5
ECO2430		63.8	68	50	VI	5.0	17.5	12	24.0	28.5	36.5
					VII	4.0	20.0	16	25.0	35.5	36.5
Horizontal type											
ECO2017	EE25/19	36.3	5	50	HI	3.75	20.0	12	24.5	23.5	20.0
ECO2020			14		HI	3.75	22.5	12	27.0	23.5	20.0
ECO2023			20		HI	3.75	25.0	12	29.5	23.5	20.0
ECO2219	EER2820	46.4	18	50	HI	5.0	20.0	12	25.0	29.0	24.0
					HI	4.0	20.0	12	25.0	26.0	24.0
ECO2225		46.4	30	50	HI	5.0	25.0	12	30.5	29.0	24.0
					HI	4.0	25.0	12	30.5	26.0	24.0
ECO2230	EER28	46.4	42	50	HI	5.0	30.0	12	35.5	29.0	24.0
					HI	4.0	30.0	12	35.5	26.0	24.0
ECO2425		63.8	41	50	HI	5.0	25.0	12	30.5	30.0	25.0
					HI	4.0	25.0	12	30.5	27.0	25.0
ECO2430	EER28L	63.8	59	50	HI	5.0	30.0	12	36.0	30.0	25.0
					HI	4.0	30.0	12	36.0	27.0	25.0
Horizontal type (SLD type)											
ECO2425SLD		46.7	29	50	HI	4.0	25.0	12	30.0	26.0	20.0

*1 Ferrite cores are not sold separately.

*2 The reference output was obtained under conditions where the frequency was 50kHz and creepage distance was 4mm. (See the relevant page for details of each shape.) The reference output differs depending on the switching device, switching frequency, transformer temperature, conditions, etc. Use this output for reference.

*3 The bobbin is made from phenol with a flame resistance grade of 94V-2 or higher.

Please be sure to request delivery specifications that provide further details on the features and specifications of the products for proper and safe use. Please note that the contents may change without any prior notice due to reasons such as upgrading.

Lineup of ECO Series

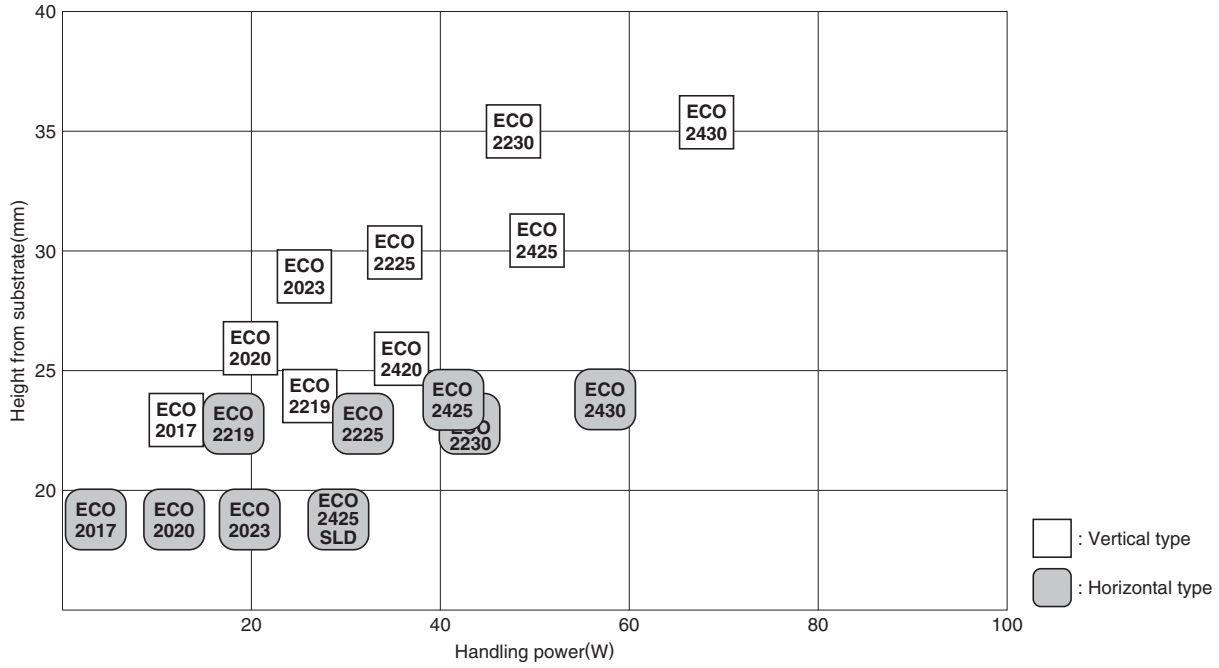

 Please be sure to request delivery specifications that provide further details on the features and specifications of the products for proper and safe use. Please note that the contents may change without any prior notice due to reasons such as upgrading.

ECO20 series For Multiple Outputs (Vertical/Horizontal types)

ELECTRICAL CHARACTERISTICS

 Recommended range

Type	Frequency	Transformer handling power(W) [Vertical/Horizontal type]*							
		Creepage distance							
		0.0mm	2.0mm	2.5mm	3.2mm	4.0mm	5.0mm	6.4mm	8.0mm
ECO2017	50kHz	33	21/18	19/14	15/10	12/ 5	7/-	-	-
	75kHz	49	31/26	28/21	23/15	17/ 8	10/-	1/-	-
	100kHz	54	34/29	31/24	25/16	19/ 8	11/-	1/-	-
ECO2020	50kHz	37	28/25	26/22	23/18	20/14	16/ 8	10/-	3/-
	75kHz	56	41/38	39/33	35/28	30/21	24/13	15/ 1	5/-
	100kHz	59	46/40	41/35	37/29	31/22	25/14	16/ 1	5/-
ECO2023	50kHz	42	33/31	31/28	29/25	26/20	22/15	17/ 8	11/-
	75kHz	62	50/46	47/42	43/37	39/31	33/23	25/13	16/-
	100kHz	64	51/47	48/43	44/37	39/31	34/24	26/13	16/-

* The Vertical type places its described creepage distance and its half distance on the terminal side and guard side, respectively. The Horizontal type places its described creepage distance on both sides.
Transformer-handling power may differ depending on switching devices, switching frequency, transformer temperature, conditions during usage, etc. Therefore, use the handling power for reference only.

Type	Core parameter			Bobbin parameter				Dimensions			Applications				
	General-purpose cores	cores material	center leg area Ae (mm ²)	Bobbin Type	Spool width (mm) min.	Spool height (mm) min.	Number of pins	Depth	Width	Height	STB	Air conditioner	DVD	BD	Others
								D (mm)max.	W (mm)max.	H (mm)max.					
ECO2017				VI	10.4	3.6	12	19.5	22.5	24.0		○			
				HI	9.8	3.7	12	24.5	23.5	20.0					
ECO2020	EE25/19 (EI22)	PC47 family	36.3	VI	13.4	3.6	12	19.5	22.5	27.0	○	○	○		
				HI	12.8	3.7	12	27.0	23.5	20.0					
ECO2023				VI	16.4	3.6	12	19.5	22.5	30.0	○	○	○		
				HI	15.8	3.7	12	29.5	23.5	20.0					

STANDARD CORE AL-value

Type	AL-value: R20 series(nH/N ²)											
	100	112	125	140	160	180	200	224	250	280	315	400
For multiple outputs												
ECO2017	○	○	○	○	○	○	○	○	○	○		
ECO2020	○	○	○	○	○	○	○	○	○	○		
ECO2023	○	○	○	○	○	○	○	○	○	○		

In order to respond to our customers' requested delivery dates and costs, TDK can provide standard GAP products (indicated by "○" in the below chart) for each shape.

Please contact us about other GAP products separately.

ECO20 series For Multiple Outputs (Vertical type)

SHAPE & DIMENSIONS

Bobbin type: V I



Type	Bobbin type	H max.
ECO2017	V I	24.0
ECO2020	V I	27.0
ECO2023	V I	30.0

RECOMMENDED BASE MATERIAL OPENING SIZE



RECOMMENDED PLANS FOR WINDINGS AND CONNECTIONS

Item	Number of secondary circuits	
	2-connection	3-connection
1st side 1-output	<p>A</p>	<p>B</p>

● Please refer to P.26 for more details about the list of plans for standard windings and connections.

ECO20 series For Multiple Outputs (Horizontal type)

SHAPE & DIMENSIONS

Bobbin type: HI



Type	Bobbin type	D max.	F
ECO2017	HI	24.5	20.0
ECO2020	HI	27.0	22.5
ECO2023	HI	29.5	25.0

RECOMMENDED BASE MATERIAL OPENING SIZE



RECOMMENDED PLANS FOR WINDINGS AND CONNECTIONS

Item	Number of secondary circuits	
	2-connection	3-connection
1st side 1-output	<p>C</p>	<p>D</p>

● Please refer to P.26 for more details about the list of plans for standard windings and connections.

ECO22 series For multiple Outputs (Vertical/Horizontal types)

ELECTRICAL CHARACTERISTICS

 Recommended range

Type	Frequency	Transformer handling power(W) [Vertical/Horizontal type]*							
		Creepage distance							
		0.0mm	2.0mm	2.5mm	3.2mm	4.0mm	5.0mm	6.4mm	8.0mm
ECO2219	50kHz	47	36/32	33/28	30/24	25/18	20/11	13/ 1	4/-
	75kHz	69	52/47	48/42	43/34	37/26	29/16	18/ 2	6/-
	100kHz	67	51/46	48/41	42/34	36/26	29/16	18/ 2	6/-
ECO2225	50kHz	57	46/43	44/40	40/35	36/30	32/23	25/14	17/3
	75kHz	78	64/59	61/54	56/48	50/41	43/32	34/19	23/4
	100kHz	77	63/58	60/53	55/47	49/40	43/31	33/18	22/4
ECO2230	50kHz	67	57/54	55/51	52/47	48/42	44/36	37/27	30/18
	75kHz	87	75/71	72/67	68/61	63/55	57/47	49/36	39/23
	100kHz	86	73/70	71/65	67/60	62/54	56/46	48/35	39/23

* The Vertical type places its described creepage distance and its half distance on the terminal side and guard side, respectively. The Horizontal type places its described creepage distance on both sides.

Transformer-handling power may differ depending on switching devices, switching frequency, transformer temperature, conditions during usage, etc. Therefore, use the handling power for reference only.

Type	Core parameter			Bobbin parameter				Dimensions			Applications				
	General-purpose cores	cores material	center leg area Ae (mm ²)	Bobbin Type	Spool width (mm) min.	Spool height (mm) min.	Number of pins	Depth	Width	Height	STB	Air conditioner	DVD	BD	Others
								D × W × H (mm)max.	W × H	H					
ECO2219				VI	11.9	4.1	12	23.0	28.5	25.0					
				VII	11.9	4.1	12	23.0	24.0	25.0					
				VIII	11.9	4.1	14	23.0	30.0	25.0	○	○			
				HI	11.6	4.3	12	25.0	29.0	24.0					
				III	11.6	4.3	12	25.0	26.0	24.0					
ECO2225	EER28 EED2820	PC47 family	46.4	VI	17.2	4.1	12	23.0	28.5	31.0					
				VII	17.2	4.1	12	23.0	24.0	31.0					
				VIII	17.2	4.1	14	23.0	30.0	31.0	○	○	○	○	○
				HI	16.9	4.3	12	30.5	29.0	24.0					
				III	16.9	4.3	12	30.5	26.0	24.0					
ECO2230				VI	22.2	4.1	12	23.0	28.5	36.0					
				VII	22.2	4.1	12	23.0	24.0	36.0					
				HI	21.9	4.3	12	35.5	29.0	24.0	○	○	○	○	○
				III	21.9	4.3	12	35.5	26.0	24.0					

STANDARD CORE AL-value

Type	AL-value: R20 series(nH/N ²)											
	100	112	125	140	160	180	200	224	250	280	315	400
For multiple outputs												
ECO2219	○	○	○	○	○	○	○	○	○	○	○	○
ECO2225	○	○	○	○	○	○	○	○	○	○	○	○
ECO2230	○	○	○	○	○	○	○	○	○	○	○	○

In order to respond to our customers' requested delivery dates and costs, TDK can provide standard GAP products (indicated by "○" in the below chart) for each shape.

Please contact us about other GAP products separately.

ECO22 series For Multiple Outputs (Vertical type)

SHAPE & DIMENSIONS

Bobbin type: VI、VII



Type	Bobbin type	W max.	H max.	P
ECO2219	VI	28.5	25.0	5.0
	VII	24.0	25.0	4.0
ECO2225	VI	28.5	31.0	5.0
	VII	24.0	31.0	4.0
ECO2230	VI	28.5	36.0	5.0
	VII	24.0	36.0	4.0

RECOMMENDED BASE MATERIAL OPENING SIZE



RECOMMENDED PLANS FOR WINDINGS AND CONNECTIONS

Item	Number of secondary circuits	
	2-connection	3-connection
1st side 1-output	<p>A</p>	<p>B</p>

● Please refer to P.26 for more details about the list of plans for standard windings and connections.

ECO22 series For Multiple Outputs (Vertical type)

SHAPE & DIMENSIONS

Bobbin type: VIII



Type	Bobbin type	H max.
ECO2219	VIII	25.0
ECO2225	VIII	31.0

RECOMMENDED BASE MATERIAL OPENING SIZE



⚠ Please be sure to request delivery specifications that provide further details on the features and specifications of the products for proper and safe use.
Please note that the contents may change without any prior notice due to reasons such as upgrading.

ECO22 series For Multiple Outputs (Vertical type)

RECOMMENDED PLANS FOR WINDINGS AND CONNECTIONS

Item	Number of secondary circuits		
	2-connection	3-connection	4-connection
1st side 1-output	E 	F 	G-1
1st side 2-output	H-1 	I-1 	
	H-2 	I-2 	

● Please refer to P.26 for more details about the list of plans for standard windings and connections.

⚠ Please be sure to request delivery specifications that provide further details on the features and specifications of the products for proper and safe use. Please note that the contents may change without any prior notice due to reasons such as upgrading.

ECO22 series For Multiple Outputs (Horizontal type)

SHAPE & DIMENSIONS

Bobbin type: HI、HII

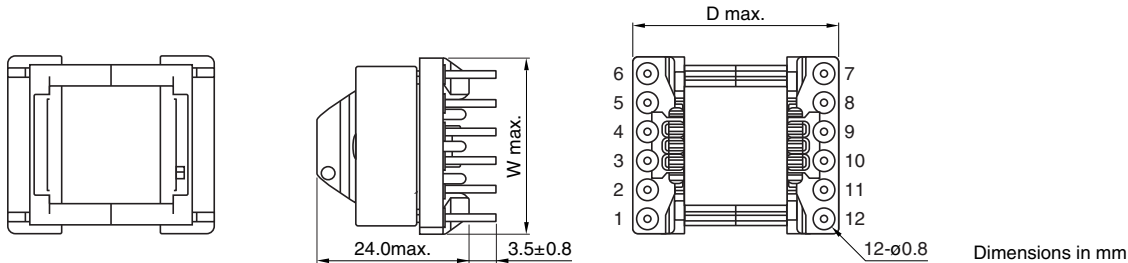

Type	Bobbin type	D max.	W max.	P	F
ECO2219	HI	25.0	29.0	5.0	20.0
	HII	25.0	26.0	4.0	20.0
ECO2225	HI	30.5	29.0	5.0	25.0
	HII	30.5	26.0	4.0	25.0
ECO2230	HI	35.5	29.0	5.0	30.0
	HII	35.5	26.0	4.0	30.0

RECOMMENDED BASE MATERIAL OPENING SIZE



RECOMMENDED PLANS FOR WINDINGS AND CONNECTIONS

Item	Number of secondary circuits	
	2-connection	3-connection
1st side 1-output	<p>C</p> <p>Diagram C shows a 2-connection winding plan with terminals 1, 2, 4, 5, 6, 7, 8, 9, 10, 11, 12. Windings are labeled NP₂, NP₁, NS_{1b}, NS_{1a}, and NB.</p>	<p>D</p> <p>Diagram D shows a 3-connection winding plan with terminals 1, 2, 4, 5, 6, 7, 8, 9, 10, 11, 12. Windings are labeled NP₂, NP₁, NS₂, NS_{1b}, NS_{1a}, and NB.</p>

● Please refer to P.26 for more details about the list of plans for standard windings and connections.

ECO24 series For multiple outputs (Vertical/Horizontal types)

ELECTRICAL CHARACTERISTICS

 : Recommended range

Type	Frequency	Transformer handling power(W) [Vertical/Horizontal type]*							
		Creepage distance							
		0.0mm	2.0mm	2.5mm	3.2mm	4.0mm	5.0mm	6.4mm	8.0mm
ECO2420	50kHz	66	50/-	46/-	41/-	35/-	28/-	18/-	6/-
	75kHz	85	65/-	60/-	53/-	46/-	36/-	23/-	8/-
	100kHz	83	63/-	59/-	52/-	45/-	35/-	22/-	7/-
ECO2425	50kHz	79	64/59	61/54	56/48	50/41	43/32	34/19	23/4
	75kHz	96	78/72	74/66	68/59	61/50	53/39	41/23	28/5
	100kHz	94	77/71	73/65	67/57	60/49	52/38	40/22	27/5
ECO2430	50kHz	95	81/76	78/72	73/66	68/59	62/51	53/39	43/25
	75kHz	107	92/87	88/82	83/75	77/67	70/58	60/44	48/29
	100kHz	105	90/85	86/80	81/73	76/66	69/56	59/43	47/28
ECO2425SLD	50kHz	57	-/44	-/40	-/35	-/29	-/22	-/12	—
	75kHz	80	-/60	-/55	-/48	-/40	-/31	-/17	—
	100kHz	78	-/59	-/54	-/47	-/39	-/30	-/16	—

* The Vertical type places its described creepage distance and its half distance on the terminal side and guard side, respectively. The Horizontal type places its described creepage distance on both sides.

Transformer-handling power may differ depending on switching devices, switching frequency, transformer temperature, conditions during usage, etc. Therefore, use the handling power for reference only.

Type	Core parameter			Bobbin parameter				Dimensions			Applications				
	General-purpose cores	cores material	center leg area Ae (mm ²)	Bobbin Type	Spool width (mm) min.	Spool height (mm) min.	Number of pins	Depth Width Height			STB	Air conditioner	DVD	BD	Others
								D × W × H (mm)max.							
ECO2420				VI	12.1	4.6	12	24.0	28.5	26.5	○	○			
				VII	12.1	4.6	14	25.0	31.5	26.5					
ECO2425	EER28 EER28L	PC47 family	63.8	VI	17.1	4.6	12	24.0	28.5	31.5					
				VII	17.1	4.6	16	25.0	35.5	31.5					
				HI	16.8	4.8	12	30.5	30.0	25.0	○	○	○	○	○
				III	16.8	4.8	12	30.5	27.0	25.0					
ECO2430				VI	22.1	4.6	12	24.0	28.5	36.5					
				VII	22.1	4.6	16	25.0	35.5	36.5					
				HI	21.8	4.8	12	36.0	30.0	25.0			○	○	○
ECO2425SLD	PC47 family	46.7		HI	16.3	4.2	12	30.0	26.0	20.0	○	○	○	○	○

STANDARD CORE AL-value

Type	AL-value: R20 series(nH/N ²)											
	100	112	125	140	160	180	200	224	250	280	315	400
For multiple outputs												
ECO2420	○	○	○	○	○	○	○	○	○	○	○	○
ECO2425	○	○	○	○	○	○	○	○	○	○	○	○
ECO2430	○	○	○	○	○	○	○	○	○	○	○	○
ECO2425SLD	○	○	○	○	○	○	○	○	○			

In order to respond to our customers' requested delivery dates and costs, TDK can provide standard GAP products (indicated by "○" in the below chart) for each shape.

Please contact us about other GAP products separately.

ECO24 series For Multiple Outputs (Vertical type)

SHAPE & DIMENSIONS

Bobbin type: VI

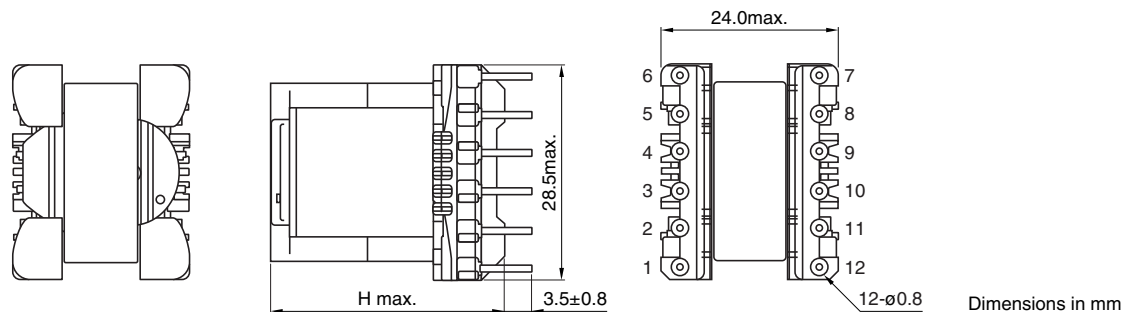

Type	Bobbin type	H max.
ECO2420	VI	26.5
ECO2425	VI	31.5
ECO2430	VI	36.5

RECOMMENDED BASE MATERIAL OPENING SIZE

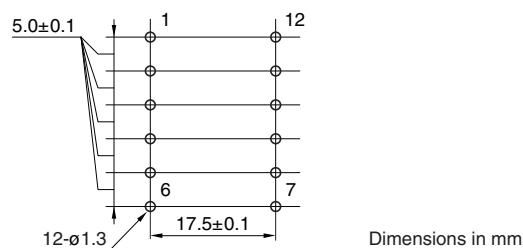

RECOMMENDED PLANS FOR WINDINGS AND CONNECTIONS

Item	Number of secondary circuits	
	2-connection	3-connection
1st side 1-output	A	B

● Please refer to P.26 for more details about the list of plans for standard windings and connections.

ECO24 series For Multiple Outputs (Vertical type)

SHAPE & DIMENSIONS

Bobbin type: VII



Type	Bobbin type	H max.
ECO2420	VII	26.5

RECOMMENDED BASE MATERIAL OPENING SIZE



⚠ Please be sure to request delivery specifications that provide further details on the features and specifications of the products for proper and safe use.
Please note that the contents may change without any prior notice due to reasons such as upgrading.

ECO24 series For Multiple Outputs (Vertical type)

RECOMMENDED PLANS FOR WINDINGS AND CONNECTIONS

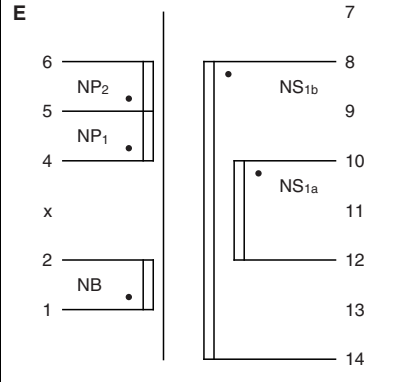
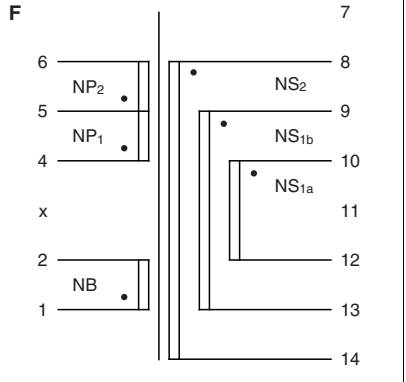
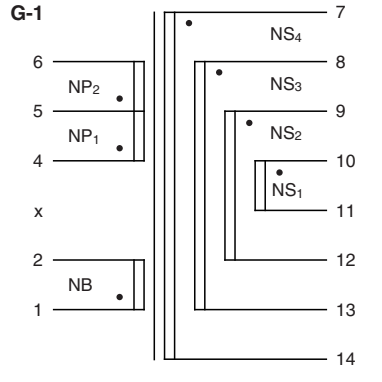
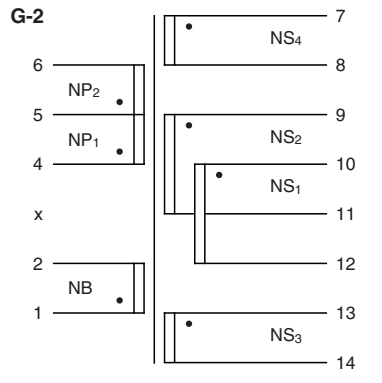
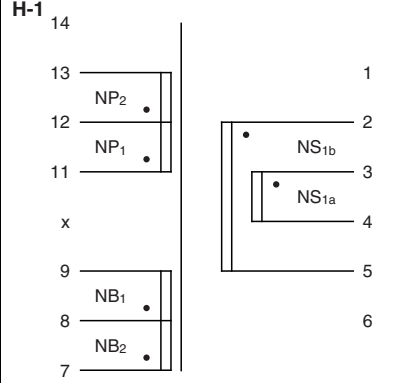
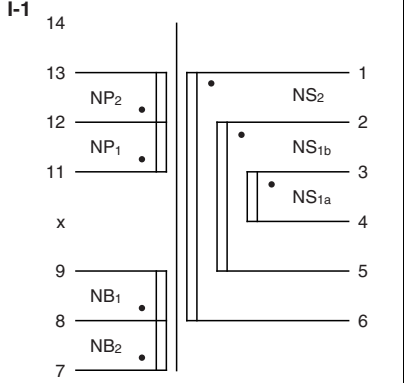
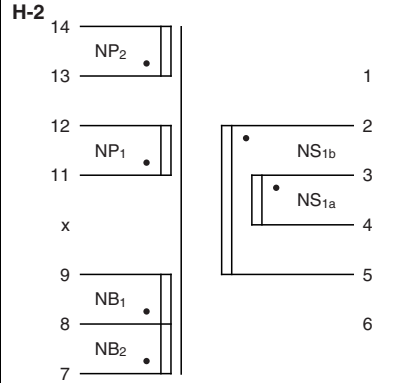
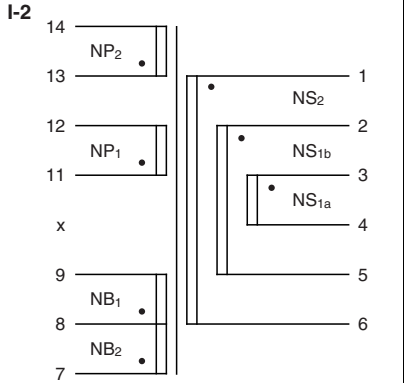
Item	Number of secondary circuits		
	2-connection	3-connection	4-connection
1st side 1-output	<p>E</p> 	<p>F</p> 	<p>G-1</p> 
			<p>G-2</p> 
1st side 2-output	<p>H-1</p> 	<p>I-1</p> 	
	<p>H-2</p> 	<p>I-2</p> 	

● Please refer to P.26 for more details about the list of plans for standard windings and connections.

 Please be sure to request delivery specifications that provide further details on the features and specifications of the products for proper and safe use. Please note that the contents may change without any prior notice due to reasons such as upgrading.

ECO24 series For Multiple Outputs (Vertical type)

SHAPE & DIMENSIONS

Bobbin type: VII



Type	Bobbin type	H max.
ECO2425	VII	31.5
ECO2430	VII	36.5

RECOMMENDED BASE MATERIAL OPENING SIZE



ECO24 series For Multiple Outputs (Vertical type)

RECOMMENDED PLANS FOR WINDINGS AND CONNECTIONS

Item	Number of secondary circuits		
	2-connection	3-connection	4-connection
1st side 1-output	J-1 	K-1 	L-1
			L-2
	J-3 	K-3 	L-3
			L-4

● Please refer to P.26 for more details about the list of plans for standard windings and connections.

⚠ Please be sure to request delivery specifications that provide further details on the features and specifications of the products for proper and safe use. Please note that the contents may change without any prior notice due to reasons such as upgrading.

ECO24 series For Multiple Outputs (Vertical type)

RECOMMENDED PLANS FOR WINDINGS AND CONNECTIONS

Item	Number of secondary circuits		
	2-connection	3-connection	4-connection
1st side 2-output	M-1 	N-1 	
	M-2 	N-2 	
	M-3 	N-3 	
	M-4 	N-4 	

● Please refer to P.26 for more details about the list of plans for standard windings and connections.

⚠ Please be sure to request delivery specifications that provide further details on the features and specifications of the products for proper and safe use.
Please note that the contents may change without any prior notice due to reasons such as upgrading.

ECO24 series For Multiple Outputs (Horizontal type)

SHAPE & DIMENSIONS

Bobbin type: HI、HII

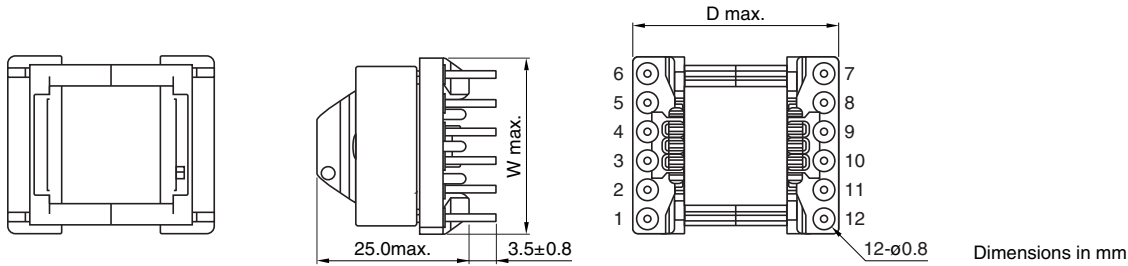

Type	Bobbin type	D max.	W max.	P	F
ECO2425	HI	30.5	30.0	5.0	25.0
	HII	30.5	27.0	4.0	25.0
ECO2430	HI	36.0	30.0	5.0	30.0
	HII	36.0	27.0	4.0	30.0

RECOMMENDED BASE MATERIAL OPENING SIZE



RECOMMENDED PLANS FOR WINDINGS AND CONNECTIONS

Item	Number of secondary circuits	
	2-connection	3-connection
1st side 1-output	<p>C</p> <p>6 NP₂</p> <p>5 NP₁</p> <p>4</p> <p>x</p> <p>2 NB</p> <p>1</p> <p>7</p> <p>8 NS_{1b}</p> <p>9 NS_{1a}</p> <p>10</p> <p>11</p> <p>12</p>	<p>D</p> <p>6 NP₂</p> <p>5 NP₁</p> <p>4</p> <p>x</p> <p>2 NB</p> <p>1</p> <p>7 NS₂</p> <p>8 NS_{1b}</p> <p>9 NS_{1a}</p> <p>10</p> <p>11</p> <p>12</p>

● Please refer to P.26 for more details about the list of plans for standard windings and connections.

ECO24 series For Multiple Outputs (Horizontal type) SLD Type

SHAPE & DIMENSIONS

Bobbin type: H I



Type	Bobbin type	D max.	W max.	P	F
ECO2425SLD	H I	30.0	26.0	4.0	25.0

RECOMMENDED BASE MATERIAL OPENING SIZE



RECOMMENDED PLANS FOR WINDINGS AND CONNECTIONS

Item	Number of secondary circuits	
	2-connection	3-connection
1st side 1-output	C	D

● Please refer to P.26 for more details about the list of plans for standard windings and connections.

ECO series List of Plans for Standard Windings and Connections

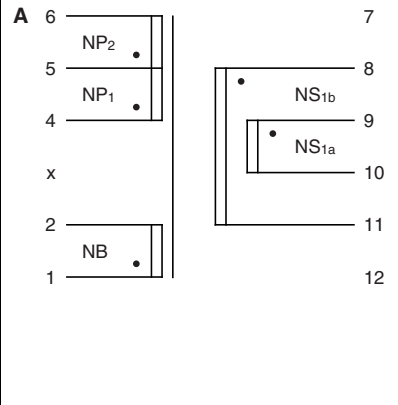
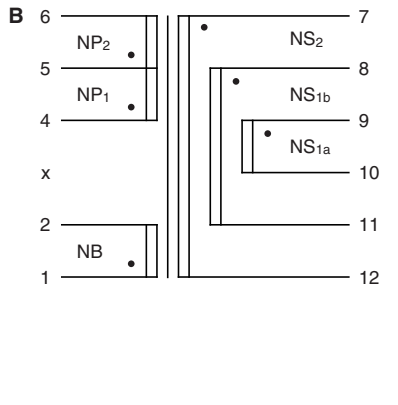
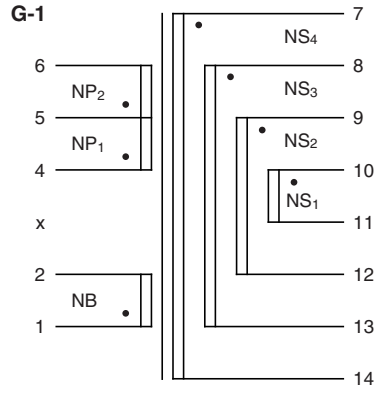
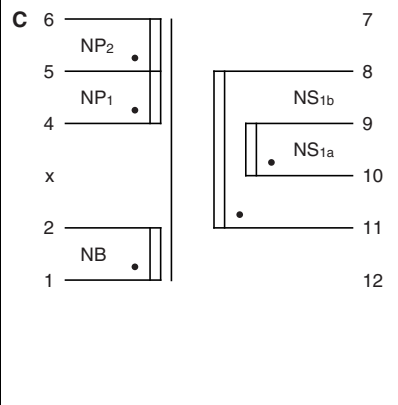
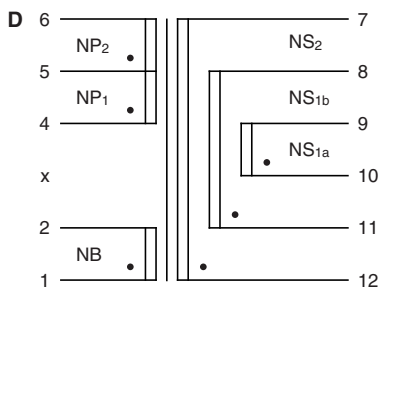
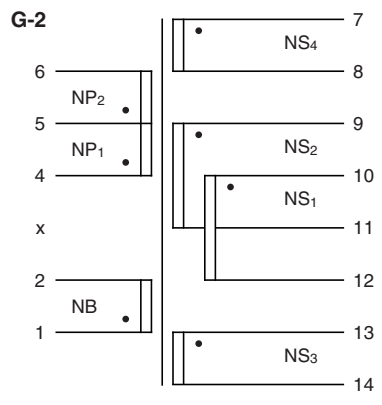
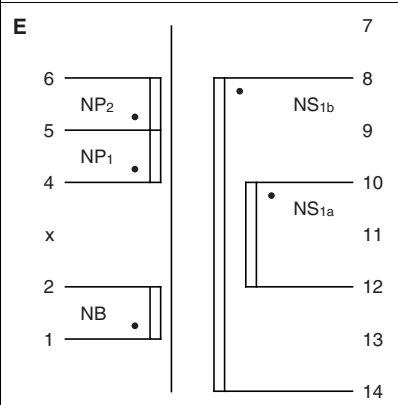
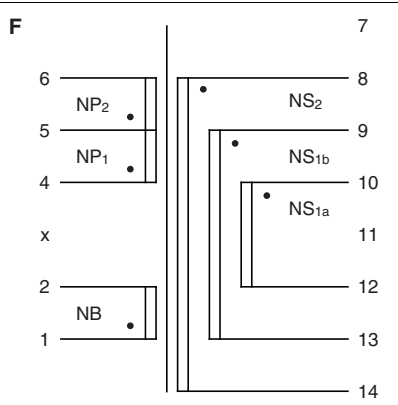
Item	Number of secondary circuits		
	2-connection	3-connection	4-connection
1st side 1-output	<p>A</p> 	<p>B</p> 	<p>G-1</p> 
	<p>C</p> 	<p>D</p> 	<p>G-2</p> 
	<p>E</p> 	<p>F</p> 	

 Please be sure to request delivery specifications that provide further details on the features and specifications of the products for proper and safe use. Please note that the contents may change without any prior notice due to reasons such as upgrading.

TRANSFORMERS



Item	Number of secondary circuits		
	2-connection	3-connection	4-connection
1st side 1-output	J-1 	K-1 	L-1
			L-2
	J-3 	K-3 	L-3
			L-4

⚠ Please be sure to request delivery specifications that provide further details on the features and specifications of the products for proper and safe use.
Please note that the contents may change without any prior notice due to reasons such as upgrading.

TRANSFORMERS



Item	Number of secondary circuits			
	2-connection	3-connection	4-connection	
1st side 2-output	H-1 14 13 NP ₂ 12 NP ₁ 11 x 9 NB ₁ 8 NB ₂ 7	1 2 NS _{1b} 3 NS _{1a} 4 5 6	I-1 14 13 NP ₂ 12 NP ₁ 11 x 9 NB ₁ 8 NB ₂ 7	1 NS ₂ 2 NS _{1b} 3 NS _{1a} 4 5 6
	H-2 14 NP ₂ 13 12 NP ₁ 11 x 9 NB ₁ 8 NB ₂ 7	1 2 NS _{1b} 3 NS _{1a} 4 5 6	I-2 14 NP ₂ 13 12 NP ₁ 11 x 9 NB ₁ 8 NB ₂ 7	1 NS ₂ 2 NS _{1b} 3 NS _{1a} 4 5 6
	M-1 16 15 NP ₂ 14 NP ₁ 13 x 11 NB ₁ 10 NB ₂ 9 8	1 2 NS ₂ 3 NS _{1a} 4 NS _{1b} 5 6 7	N-1 16 15 NP ₂ 14 NP ₁ 13 x 11 ND 10 NV 9 8	1 NS ₃ 2 NS ₂ 3 4 NS ₁ 5 6 7
	M-2 16 15 NP ₂ 14 NP ₁ 13 x 11 NB ₁ 10 NB ₂ 9 8	1 2 NS ₂ 3 NS _{1a} 4 NS _{1b} 5 6 7	N-2 16 15 NP ₂ 14 NP ₁ 13 x 11 ND 10 NV 9 8	1 NS ₃ 2 NS ₂ 3 4 NS ₁ 5 6 7

⚠ Please be sure to request delivery specifications that provide further details on the features and specifications of the products for proper and safe use. Please note that the contents may change without any prior notice due to reasons such as upgrading.

TRANSFORMERS



Item	Number of secondary circuits		
	2-connection	3-connection	4-connection
1st side 2-output	<p>M-3</p>	<p>N-3</p>	
	<p>M-4</p>	<p>N-4</p>	

⚠ Please be sure to request delivery specifications that provide further details on the features and specifications of the products for proper and safe use.
Please note that the contents may change without any prior notice due to reasons such as upgrading.

Design Reference for Switching Power Transformers

• Maximum allowable temperature

The maximum ambient temperature of the transformer is E Class (120°C).

However, there is no E Class for transformers shipped for North America; therefore, the maximum ambient temperature is Class 105 (105°C). [Class 130 (130°C) is possible when UL1446 insulating system is applied.]

• Temperature rise in Transformers

In normal design condition, 55°C or less (using the resistance method) is the target of temperature rise of windings. Therefore, the maximum ambient temperature at this time is 65°C (50°C max. for North America).

In case of measuring the temperature of the windings by thermocouple, 10 to 15°C more would be allowable.

• Dealing with safety regulations

Designs are made in consideration of materials, structures and so on that the designed transformers comply with designated safety regulations.

(1) Regarding the core

To be handled in the same manner as Basic Insulation.

(2) Distance between transformer and other parts

Please keep the distance between the transformer and other parts in accordance with applicable safety standards.

• Concerning of the influence of leakage flux

Due to the fact that there is always some degree of leakage flux from transformer, designs should be made to keep them apart as much as possible from parts that are easily affected by this.

• Magnetic saturation of the core

(1) Magnetic operating condition of the core in the transformer are determined by maximum operation temperature (including temperature rise) and driving condition in circuits. If product is used in condition that exceed these conditions, there is a possibility of occurring magnetic saturation of the core. The following items could be possible cause of core saturation.

- The product is used in conditions that exceed the maximum operating temperature.
- Operating frequencies are lower than the ones initially designed. (longer ON time)
- The input voltage is abnormally higher than the specified values.

(2) To check on the saturation of the core it is possible to judge from current waveforms of primary winding. Current flowing in the inductor changes in a straight line in relation to time as in the figure a) in accordance with

$$I = \frac{E}{L} \times T.$$

However, in the event that a saturation phenomena has occurred in the core, inductance is reduced causing a rapid and drastic increase of current as shown figure b).



(3) In this case, there is possibility that a breakdown may occur due to surpassing the rated current of the switch it is necessary to have over current protection circuit or modify transformer design.

• Circuit topologies of switching power supply

The term "topology" refers to the arrangement of the power components within the switching power supply design. There are several different kind of circuit topologies as following;



• Which topology of switching power supply to use?

Each topology has its relative merit in terms of cost and performance. One topology may have a low parts cost but only be able to provide a limited amount of power; another may have ample power capability but cost more, and so on.

The following relationship between output voltage and power give us one suggestion when we need to chose topology in given conditions;



• The deferece of power conversion between Forward and Flyback modes.

Since the forward mode converter is a system that performs power transmission to the output side during ON period of switching transistor, it is possible to work with the large output current. Consequently, forward converter method is suitable to large current output with relatively lower output voltage.

To the contrary, Flyback mode converter is a system that input power is stored within the Inductor or primary coil in the transformer as a magnetic energy during ON period of switching transistor and the stored energy transmit to output side during OFF period of switching transistor. Accordingly, Flyback mode converter is suitable to high voltage and low current output, and does not suite to large current output.

• The stored energy within the inductor.



Energy stored in the inductor L_p is $W = \frac{1}{2} \times L_p \times I_p^2 \times [J]$

when I_p is a triangular wave,
and electric power (energy per unit time) is

$$P = \frac{[J]}{[S]} = \frac{1}{2} \times L_p \times I_p^2 \times f [W]$$

Where,

L_p : Inductance of primary winding

I_p : Peak value of primary current

f : Switching frequency

• How to decide primary inductance (L_p)?

(1) When the self-excited flyback system is selected:

$$\text{Using the formula } P = \frac{1}{2} \times L_p \times I_p^2 \times f [W],$$

it is possible to calculate the inductance value needed for the desired output P under the fixed I_p value.

By deriving $E \times T_{on} = L_p \times i$ from the formula

$$E = L_p \times \frac{di}{dt},$$

the current which flows through the inductor becomes $i = \frac{E \times T_{on}}{L_p}$.

By substituting this with $P = \dots$, the formula of

$$P = \frac{1}{2} \times L_p \times \left(\frac{E \times T_{on}}{L_p} \right)^2 \times f = \frac{1}{2} \times \frac{E^2 \times T_{on}^2}{L_p} \times f \text{ results.}$$

From this, the formula $L_p = \frac{E^2 \times T_{on}^2}{2 \times P} \times f$ results.

Where,

E : Input voltage

T_{on} : On time

f : Switching frequency

In actual designs this value is to be slightly lowered in consideration of the transformer's efficiency.

(2) When the separately-excited flyback system is selected:

The coefficient k is added because a direct current is superimposed on the primary current waveform.

$$L_p = \frac{E^2 \times T_{on}^2}{2 \times P} \times f \times \frac{(1+k)}{(1-k)}$$

The primary current waveforms

The self-excited flyback system(RCC)



The separately-excited flyback system



• How to decide number of turns of primary winding?

$$N_P = \frac{E_{\min.} \times T_{\text{on max.}}}{\Delta B \times A \times (1-k)}$$

Where,

$E_{\min.}$: Lower limit value of input voltage (Vdc)

A: Core cross section area (m²)

D: Duty ratio

$T_{\text{on max.}}$: The maximum ON time for switching transistor (sec.)

Δ : Operating flux density (T)

(1) When the self-excited flyback system is selected:

$$N_P = \frac{E_{\min.} \times T_{\text{on max.}}}{\Delta B \times A} \quad (T_{\text{on max.}} = \frac{D}{f})$$

(2) When the separately-excited flyback system is selected:

$$N_P = \frac{E_{\min.} \times T_{\text{on max.}}}{\Delta B \times A \times (1-k)}$$

Precautions must be taken as the upper limit value of ΔB changes according to core materials, operating temperatures, frequencies, etc.

• Determining of secondary winding

ON-OFF mode

As it is necessary to consider the voltage drop of the rectifier diode on the secondary side,

$$N_S = N_P \times \frac{V_o + V_F}{E_{\min.}} \times \frac{1-D}{D}$$

Where,

V_F : Voltage drop of the rectifier diode

V_o : Output voltage

$$\frac{T_{\text{on max.}}}{1/f} = D : \text{Duty ratio}$$

• Example of drive waveforms

(1) When the self-excited flyback system is selected (RCC)



(2) When the separately-excited flyback system is selected

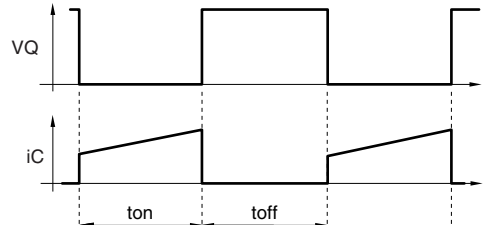

• In order for designing the transformer, the following conditions are necessary.

It is greatly appreciated customer give us those conditions by filling out required information with the appended "Transformer specifications / inquiry form".

(1) Circuit topology

Flyback system, forward system, etc.

(2) Used IC

Design with a high degree of perfection is possible when IC manufacturer and model number information are provided.

(3) Input voltage range

The lower limit of rectified voltage is important, in particular.

(4) Operating frequency (fixed/variable)

It is especially necessary to determine the lower limit frequency for the maximum load condition in Flyback converter.

(5) Maximum duty ratio

It is necessary to specify maximum ON time when input voltage is lower limit, approximately 45% should be the maximum for external excitation system.

(6) Operating temperature range, maximum temperature rise

This is the allowable temperature rise in the transformer, should be equal to the value that ambient temperature has been taken from the temperature index of the materials which is 120°C (105°C in UL system).

(7) Required safety regulations

Structures and materials are chosen to comply with required safety regulations.

(8) Output voltage/current

Required for determination of the winding ratios and wire gage.

(9) Transformer outside dimension

It is necessary for determining the shape.

(10) Instructions concerning circuit designs and pin configuration of transformer

Type of the secondary rectifier diode is important in particular because of voltage drop between First recovery and Schottky barrier type is different, it will affect to design of number of turns of transformer.

Transformers for Switching Power Supplies Specification Request Form Issued on _____

1. **Company name** _____
Address _____
 2. **Department, applicant's name(Including the sample-sending destination)**
Name: _____
TEL/FAX: _____
E-mail: _____

3. **Circuit system**
 Flyback method Forward method Others _____

4. **Input specifications**
AC input voltage: Rated _____ (V) ~ _____ (V) **Operating range:** _____ (V) ~ _____ (V)
DC input voltage: Rated _____ (V) ~ _____ (V) **Operating range:** _____ (V) ~ _____ (V)

5. **Output voltage/Current/Diode used (diode voltage drop)**

Output specifications	Example	Output1	Output2	Output3	Output4	Output5	Output6	Output7	VCC
Power application	Motor								
Output voltage(V) (Accuracy)	50V (±5V)								
Output Current(A)	Minimum	0							
	Typical ΔT measuring condition	0.8							
	Maximum time	1A, 10sec.							
	Peak time	2A, 3sec.							
Primary/Secondary	Secondary								
Feedback	No								
Rectifier diode	FRD								
V _F (V)	0.1								

(Rectifier diode F.R.D: Fast Recovery Diode, S.B.D: Schottky Barrier Diode)
 • Request for connection method Yes No (When checking "Yes", please attach a drawing separately.) • Pin assignments changes Possible Impossible

6. **Clock frequency (Flexible / Fixed)** fsw _____ ~ _____ (kHz)
 7. **Max. duty or max. ON time** D max. _____ (%), T max. _____ (s)
 8. **Input capacitor capacitance** C_{IN} _____ (μF)
 (If not specified, design will be performed using a value of () μF x 4, which is times greater than the output power for 100V and worldwide transformers, and an output power of () μF for 200V transformers.)
 9. **Operating temperature range, max. temperature rise, and ambient temperature** _____ to _____ (°C) ΔT _____ (°C Typ. Max.) Ambient temperature _____ °C

10. **Desired core size and outer dimensions of transformer**
 Core size _____ Outer dimensions of the transformer L _____ x W _____ x H _____ mm max.

11. **Safety standard compliance** Electrical Appliances and Material Safety Act, Appendix 8 CSA _____ Others _____
 UL _____ IEC _____
 Application for the transformer Yes* Set purchase No (Please bear in mind that the application fee may be borne by the customer.)
 Insulation type Basic insulation Reinforced insulation Double insulation Other ()
 Pollution degree 1 2 3 (If not specified, design will be performed with a pollution degree of 2.)

12. **Safety distance** (Please enter the distance prescribed by the company.)
 Primary - secondary: _____ mm or greater Primary - primary: _____ mm or greater Primary - core: _____ mm or greater
 Secondary - secondary: _____ mm or greater Secondary - core: _____ mm or greater

13. **Withstand voltage** (Please enter the voltage prescribed by the company.)
 Primary - secondary: AC _____ (V) _____ (min) _____ (mA) Primary - core: AC _____ (V) _____ (min) _____ (mA)
 Primary - primary: AC _____ (V) _____ (min) _____ (mA) Secondary - core: AC _____ (V) _____ (min) _____ (mA)
 Secondary - secondary: AC _____ (V) _____ (min) _____ (mA)

14. **Please Enter the Power Devices to be Used.**
In addition, if there are recommended transformer specifications, etc., presented by the device manufacturer, please attach these separately.
Manufacturer name: _____ **Product No.:** _____

15. **Mass production and prototyping information**
 Final set name: _____ Mass production requested price/currency: _____
 Acceptance conditions of the above price, delivery location (FOB CHN, CIF LA., DDP Paris, etc.) _____
 Mass production quantity _____ pcs. /M Mass production start time _____ Mass production location _____
 Prototyping time: (ES1) _____ (ES2) _____ (PP1) _____ (PP2) _____ (MP1) _____

16. **Required sample quantity** _____ pcs. **Requested delivery time:** _____

17. If there are any other requests (priorities in the company, size or price, etc.) or alterable items, please provide a description.

Person in Charge from Sales Promotion Dep.: _____ Recorded Date _____
 Person in Charge from Sales Dep.: _____ Recorded Date _____
 Prototype No.: _____ Recorded Date _____



Компания «ЭлектроПласт» предлагает заключение долгосрочных отношений при поставках импортных электронных компонентов на взаимовыгодных условиях!

Наши преимущества:

- Оперативные поставки широкого спектра электронных компонентов отечественного и импортного производства напрямую от производителей и с крупнейших мировых складов;
- Поставка более 17-ти миллионов наименований электронных компонентов;
- Поставка сложных, дефицитных, либо снятых с производства позиций;
- Оперативные сроки поставки под заказ (от 5 рабочих дней);
- Экспресс доставка в любую точку России;
- Техническая поддержка проекта, помощь в подборе аналогов, поставка прототипов;
- Система менеджмента качества сертифицирована по Международному стандарту ISO 9001;
- Лицензия ФСБ на осуществление работ с использованием сведений, составляющих государственную тайну;
- Поставка специализированных компонентов (Xilinx, Altera, Analog Devices, Intersil, Interpoint, Microsemi, Aeroflex, Peregrine, Syfer, Eurofarad, Texas Instrument, Miteq, Cobham, E2V, MA-COM, Hittite, Mini-Circuits, General Dynamics и др.);

Помимо этого, одним из направлений компании «ЭлектроПласт» является направление «Источники питания». Мы предлагаем Вам помощь Конструкторского отдела:

- Подбор оптимального решения, техническое обоснование при выборе компонента;
- Подбор аналогов;
- Консультации по применению компонента;
- Поставка образцов и прототипов;
- Техническая поддержка проекта;
- Защита от снятия компонента с производства.



Как с нами связаться

Телефон: 8 (812) 309 58 32 (многоканальный)

Факс: 8 (812) 320-02-42

Электронная почта: org@eplast1.ru

Адрес: 198099, г. Санкт-Петербург, ул. Калинина, дом 2, корпус 4, литера А.