

## Rotary DIP Switch

## A6R/A6RV

### Through-hole mounting Rotary DIP Switches

- Top/Side-actuated, and Flat/Extended-actuator models available.
- Actuator with an O-ring sealed structure prevents the ingress of dirt and dust.
- Two different terminal arrangements allow the flexibility of circuit design.

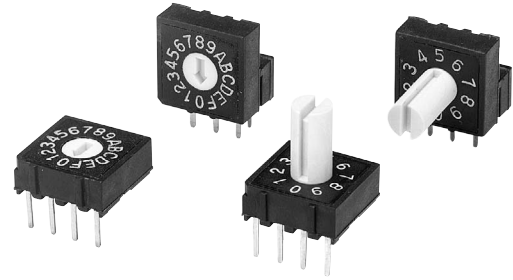

RoHS Compliant

### List of Models

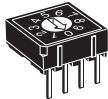
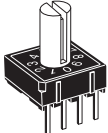
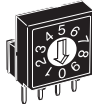
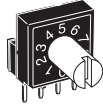
Type (actuator color)				Top-actuated, flat (white)	Top-actuated, extended actuator (white)	Side-actuated, flat (white)	Side-actuated, extended actuator (white)
Number of positions	Quantity per tube	Terminal arrangement	Output code				
10	48	4 × 1	BCD Decimal	A6R-101RF	A6R-101RS	A6RV-101RF	A6RV-101RS
		3 × 3		A6R-102RF	A6R-102RS	A6RV-102RF	A6RV-102RS
16	48	4 × 1	BCD Hexadecimal	A6R-161RF	A6R-161RS	A6RV-161RF	A6RV-161RS
		3 × 3		A6R-162RF	A6R-162RS	A6RV-162RF	A6RV-162RS

Note: Order in multiples of the package quantity.

### Ratings/Characteristics

<b>Ratings</b>	25 mA at 24 VDC, 10 μA (minimum current) at 3.5 VDC	
<b>Ambient operating temperature</b>	-25 to +80°C 60%RH max. (with no icing or condensation)	
<b>Ambient operating humidity</b>	35% to 95% (at +5 to +35°C)	
<b>Insulation resistance</b>	100 MΩ min. (at 250 VDC)	
<b>Contact resistance</b>	200 mΩ max. (initial value)	
<b>Dielectric strength</b>	Between terminals	250 VAC for 1 min
<b>Vibration resistance</b>	Malfunction	10 to 55 Hz, 1.5-mm double amplitude
<b>Shock resistance</b>	Malfunction	300 m/s <sup>2</sup> min.
<b>Durability</b>	Electrical	5,000 steps min.
<b>Operating torque</b>	1.96 × 10 <sup>-2</sup> N·m {2 gf·m} max.	
<b>Weight</b>	Top-actuated: Approx. 0.6 g Side-actuated: Approx. 0.8 g (Add 0.13 g for the extended-actuator type of each model.)	

### Output Codes

#### 10-position Models

Code	BCD Decimal code			
	Position	1	2	4
0				
1	●			
2		●		
3	●	●		
4			●	
5	●		●	
6		●	●	
7	●	●	●	
8				●
9	●			●

#### 16-position Models

Code	BCD Hexadecimal code			
	Position	1	2	4
0				
1	●			
2		●		
3	●	●		
4			●	
5	●		●	
6		●	●	
7	●	●	●	
8				●
9	●			●
A		●		●
B	●	●		●
C			●	●
D	●		●	●
E		●	●	●
F	●	●	●	●

Note: "●" indicates that the internal switch is ON.

■ Dimensions (Unit: mm)

● Top-actuated Flat Models with 4×1 Terminal Arrangement

A6R-101RF  
A6R-161RF

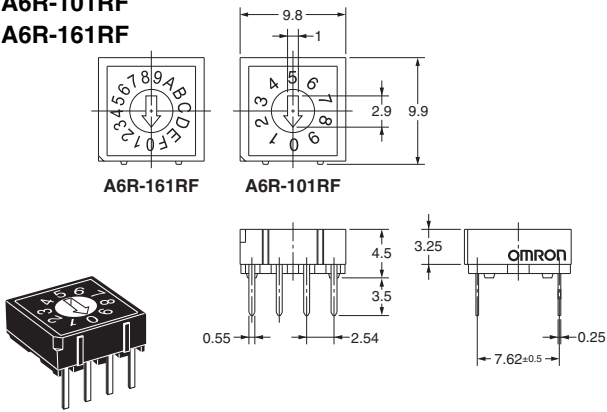

● Top-actuated Extended-actuator Models with 4×1 Terminal Arrangement

A6R-101RS  
A6R-161RS

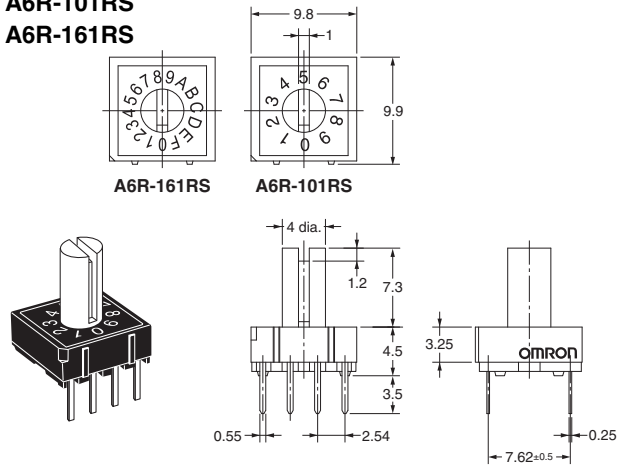

● Top-actuated Flat Models with 3×3 Terminal Arrangement

A6R-102RF  
A6R-162RF

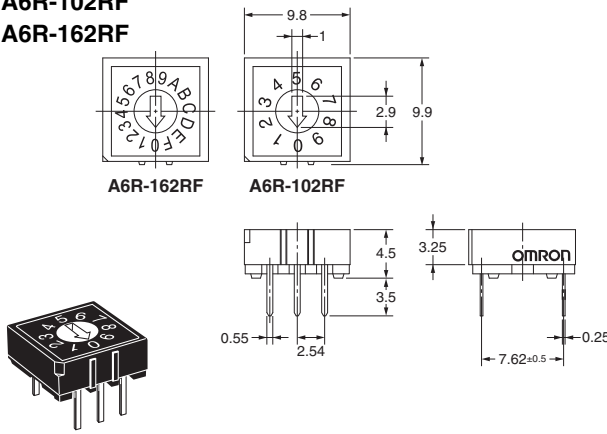

● Top-actuated Extended-actuator Models with 3×3 Terminal Arrangement

A6R-102RS  
A6R-162RS

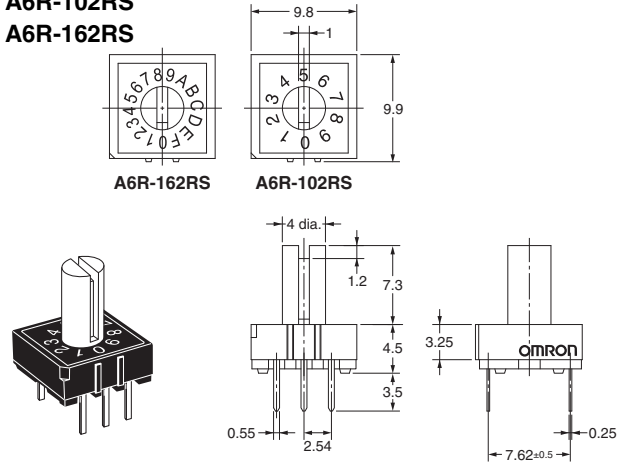

● Side-actuated Flat Models with 4×1 Terminal Arrangement

A6RV-101RF  
A6RV-161RF

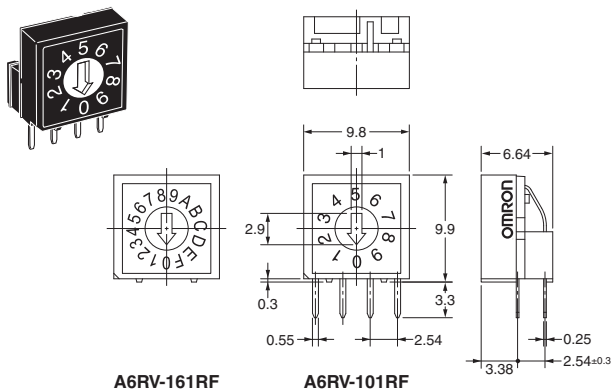

● Side-actuated Extended-actuator Models with 4×1 Terminal Arrangement

A6RV-101RS  
A6RV-161RS

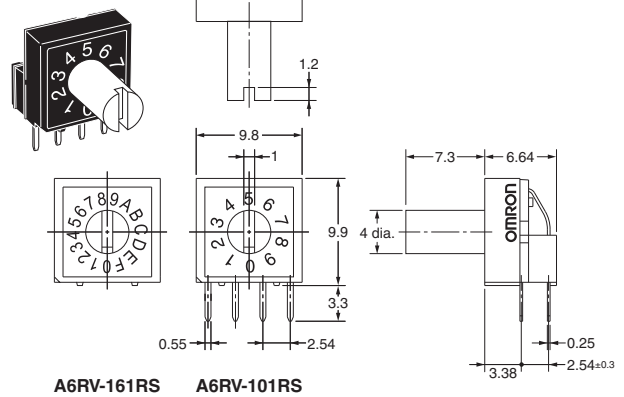

Note: Unless otherwise specified, a tolerance of ±0.4 mm applies to all dimensions.

● Side-actuated Flat Models with 3×3 Terminal Arrangement

A6RV-102RF  
A6RV-162RF

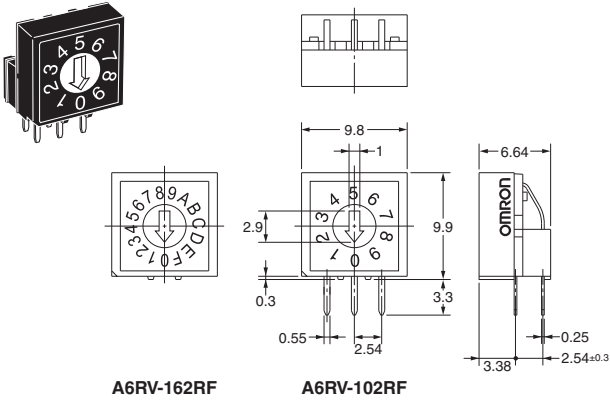

● Side-actuated Extended-actuator Models with 3×3 Terminal Arrangement

A6RV-102RS  
A6RV-162RS

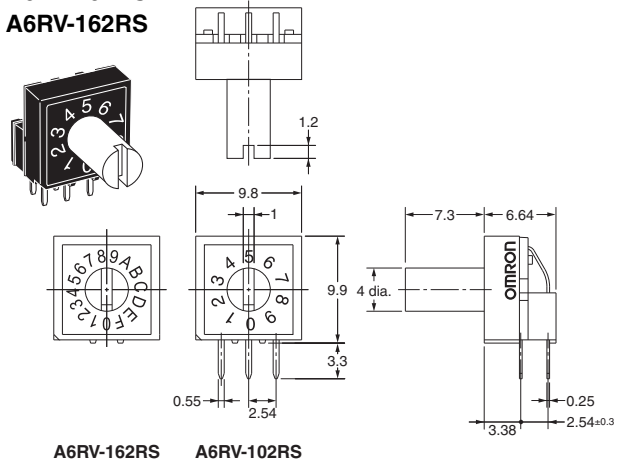

■ PCB Dimensions

● Top-actuated Models  
4×1 Terminal Arrangement

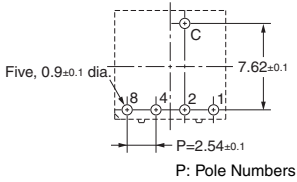

3×3 Terminal Arrangement

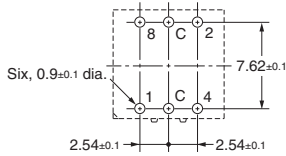

● Side-actuated Models  
4×1 Terminal Arrangement

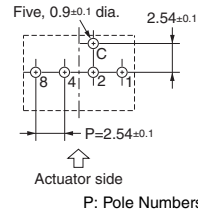

3×3 Terminal Arrangement

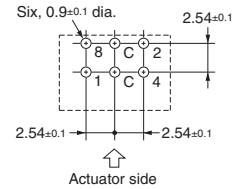

Note: Unless otherwise specified, a tolerance of ±0.4 mm applies to all dimensions.

■ Internal Connections

Contact Form (Top View)

● Top-actuated Models  
4×1 Terminal Arrangement

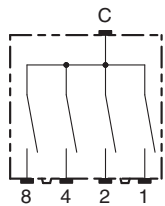

3×3 Terminal Arrangement

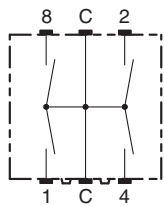

● Side-actuated Models  
4×1 Terminal Arrangement

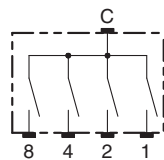

3×3 Terminal Arrangement

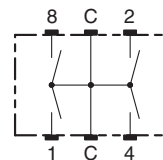

■ Precautions

Be sure to read the Safety precautions common to all DIP Switches for correct use.

- Application examples provided in this document are for reference only. In actual applications, confirm equipment functions and safety before using the product.
- Consult your OMRON representative before using the product under conditions which are not described in the manual or applying the product to nuclear control systems, railroad systems, aviation systems, vehicles, combustion systems, medical equipment, amusement machines, safety equipment, and other systems or equipment that may have a serious influence on lives and property if used improperly. Make sure that the ratings and performance characteristics of the product provide a margin of safety for the system or equipment, and be sure to provide the system or equipment with double safety mechanisms.

**Note: Do not use this document to operate the Unit.**

**OMRON Corporation**

**ELECTRONIC AND MECHANICAL COMPONENTS COMPANY**

**Contact: [www.omron.com/ecb](http://www.omron.com/ecb)**

**Cat. No. A212-E1-01  
0812(0207)(O)**



Компания «ЭлектроПласт» предлагает заключение долгосрочных отношений при поставках импортных электронных компонентов на взаимовыгодных условиях!

Наши преимущества:

- Оперативные поставки широкого спектра электронных компонентов отечественного и импортного производства напрямую от производителей и с крупнейших мировых складов;
- Поставка более 17-ти миллионов наименований электронных компонентов;
- Поставка сложных, дефицитных, либо снятых с производства позиций;
- Оперативные сроки поставки под заказ (от 5 рабочих дней);
- Экспресс доставка в любую точку России;
- Техническая поддержка проекта, помощь в подборе аналогов, поставка прототипов;
- Система менеджмента качества сертифицирована по Международному стандарту ISO 9001;
- Лицензия ФСБ на осуществление работ с использованием сведений, составляющих государственную тайну;
- Поставка специализированных компонентов (Xilinx, Altera, Analog Devices, Intersil, Interpoint, Microsemi, Aeroflex, Peregrine, Syfer, Eurofarad, Texas Instrument, Miteq, Cobham, E2V, MA-COM, Hittite, Mini-Circuits, General Dynamics и др.);

Помимо этого, одним из направлений компании «ЭлектроПласт» является направление «Источники питания». Мы предлагаем Вам помощь Конструкторского отдела:

- Подбор оптимального решения, техническое обоснование при выборе компонента;
- Подбор аналогов;
- Консультации по применению компонента;
- Поставка образцов и прототипов;
- Техническая поддержка проекта;
- Защита от снятия компонента с производства.



#### Как с нами связаться

**Телефон:** 8 (812) 309 58 32 (многоканальный)

**Факс:** 8 (812) 320-02-42

**Электронная почта:** [org@eplast1.ru](mailto:org@eplast1.ru)

**Адрес:** 198099, г. Санкт-Петербург, ул. Калинина, дом 2, корпус 4, литера А.