

MAX17671FEVKIT# Evaluation Kit

General Description

The MAX17671F evaluation kit (EV kit) is a fully assembled and tested circuit board that demonstrates the performance of the MAX17671F dual-output regulator integrating a high-efficiency, high voltage, fixed output voltage, synchronous step-down DC-DC converter, and a high-PSRR, low-noise, fixed-output linear regulator. The EV kit is designed for a high efficiency solution, and generates a 5V step-down converter output voltage and a fixed 3.3V linear regulator output voltage at load currents up to 150mA and 50mA, respectively. When the linear regulator output is loaded, the step-down converter output current is reduced by I_{LDO} , where I_{LDO} is the load current on the linear regulator output. The EV kit draws only 70 μ A supply current under no-load conditions. The step-down converter is programmed to a switching frequency of 200kHz and delivers a peak efficiency of 90% with the supplied components. The dual-output device is simple to use and easily configurable with minimal external components. The EV kit features adjustable input undervoltage lockout, open-drain \overline{RESET} signal, hysteretic peak current-limit protection and external frequency synchronization.

Evaluates: MAX17671 5V Step-Down Converter and 3.3V Linear Regulator Output Voltage Application

Benefits and Features

- 6.5V to 60V Input-Voltage Range for the Step-Down Converter
- 5V Step-Down Converter Output Voltage, Up To 150mA Continuous Load Current
- 3.3V Linear Regulator Output Voltage, Up To 50mA Continuous Load Current
- Peak Efficiency of 90% for the Step-Down Converter
- 70 μ A No-Load Supply Current
- 200kHz Switching Frequency
- Internal Soft-Start
- EN/UVLO Input, Resistor-Programmable UVLO Threshold
- MODE/SYNC Pin to Select PWM or PFM Mode
- Open-Drain \overline{RESET} Output to Monitor Dual Outputs
- External Frequency Synchronization
- Overcurrent and Overtemperature Protection
- Proven PCB Layout
- Fully Assembled and Tested

[Ordering Information](#) appears at end of data sheet.

MAX17671FEVKIT# Evaluation Kit

Quick Start

Required Equipment

- MAX17671FEVKIT#
- 6.5V to 60V, 200mA DC-input power supply
- Two loads capable of sinking 150mA and 50mA
- Two digital voltmeters (DVM)

Procedure

The EV kit is fully assembled and tested. Follow the steps below to verify board operation. **Caution: Do not turn on the power supply until all connections are completed.**

- 1) Set the power supply at a voltage between 6.5V and 60V. Disable the power supply.
- 2) Connect the positive terminal of the power supply to the VIN PCB pad and the negative terminal to the nearest GND PCB pad. Connect the positive terminal of the 150mA load to the VOUT PCB pad and the negative terminal to the nearest GND PCB pad. Connect the positive terminal of the 50mA load to the OUTL PCB pad and the negative terminal to the nearest GND PCB pad.
- 3) Connect the DVMs across the VOUT PCB pad and the nearest GND PCB pad, and across the OUTL PCB pad and the nearest GND PCB pad.
- 4) Verify that the jumper JU1 is open (see [Table 1](#)).
- 5) Select the shunt position on the jumper JU2 according to the intended mode of operation (see [Table 2](#)).
- 6) Turn on the DC power supply.
- 7) Enable the loads. If linear regulator output is not loaded, step-down converter output can be loaded up to 150mA. Else, it can be loaded up to $(150 - I_{LDO})$ mA, where I_{LDO} is the load current on the linear regulator output in mA.
- 8) Verify that the DVMs display 5V and 3.3V.
- 9) Vary the input voltage from 6.5V to 60V, and vary the load currents on step-down converter and linear regulator outputs, and verify that the output voltages of step-down converter and linear regulator are 5V and 3.3V, respectively.

Detailed Description

The MAX17671F evaluation kit (EV kit) is a fully assembled and tested circuit board that demonstrates the performance of the MAX17671F dual-output regulators integrating a high-efficiency, high voltage, fixed output voltage, synchronous step-down DC-DC converter, and a high-PSRR, low-noise, fixed output linear regulator. The step-down converter operates over a wide input range of

Evaluates: MAX17671 5V Step-Down Converter and 3.3V Linear Regulator Output Voltage Application

6.5V to 60V and the input of the linear regulator is connected to the output of the step-down converter. The EV kit is designed for a high efficiency solution, and generates a 5V step-down converter output voltage and a fixed 3.3V linear regulator output voltage at load currents up to 150mA and 50mA, respectively. When the linear regulator output is loaded, the step-down converter output current is reduced by I_{LDO} , where I_{LDO} is the load current on the linear regulator output. The EV kit draws only 70 μ A supply current under no-load conditions. The step-down converter is programmed to a switching frequency of 200kHz and delivers a peak efficiency of 90% with the supplied components. The dual-output device is simple to use and easily configurable with minimal external components. The EV kit features adjustable-input undervoltage lockout, open-drain $\overline{\text{RESET}}$ signal, hysteric peak current-limit protection and external frequency synchronization.

This EV kit includes an EN/UVLO PCB pad and JU1 to enable the step-down converter output at a desired input voltage. The MODE/SYNC PCB pad and JU2 are provided for selecting the intended mode of operation and to allow an external clock to synchronize the step-down converter. A $\overline{\text{RESET}}$ PCB pad is available for monitoring the RESET output.

Setting the Input EN/UVLO Level

The device offers an adjustable-input undervoltage lockout level. Set the voltage at which the device turns on with a resistive voltage-divider connected from IN to GND. Connect the center node of the divider to EN/UVLO as shown in [Figure 1](#). Choose R1 to be 3.3M Ω and then calculate R2 as follows:

$$R2 = \frac{R1 \times 1.215}{(V_{INU} - 1.215)}$$

where V_{INU} is the voltage above which the device is required to turn on. The allowed minimum value of V_{INU} is 4V. See [Table 1](#) for proper jumper settings.

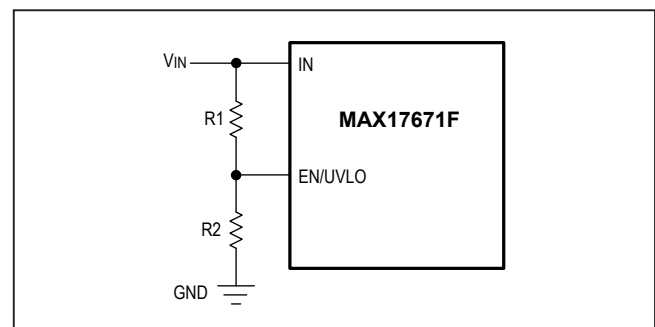

Figure 1. Setting the Input-Undervoltage Lockout

MAX17671FEVKIT# Evaluation Kit

Evaluates: MAX17671 5V Step-Down Converter and 3.3V Linear Regulator Output Voltage Application

MODE Selection and External Clock Synchronization (MODE/SYNC)

The device features a MODE/SYNC pin for selecting either forced PWM or PFM mode of operation. If the MODE/SYNC pin is grounded, the device operates in a constant-frequency PWM mode at all loads. If the MODE/SYNC pin is unconnected, the device operates in PFM mode at light loads. Refer to the MAX17671 IC data sheet for more information on PWM and PFM modes of operation.

Table 2 shows the EV kit jumper settings that can be used to configure the desired mode of operation.

The internal oscillator of the device can be synchronized to an external clock signal on the MODE/SYNC pin. The external synchronization clock frequency must be between $1.1 \times f_{SW}$ and $1.4 \times f_{SW}$, where f_{SW} is the

frequency programmed by the resistor (R5) connected to the RT pin. The minimum external clock on-time and off-time pulse-widths should be greater than 100ns. The jumper JU2 must be unconnected before applying the external clock at the MODE/SYNC pin.

RESET Output

The EV kit provides a $\overline{\text{RESET}}$ PCB pad to monitor the step-down converter output voltage and the linear regulator output voltage. $\overline{\text{RESET}}$ goes to high impedance 2.1ms after both step-down converter and linear regulator outputs rise above 95% of their nominal set value, if V_{INL} is above V_{INL_UVLO} (2.18V typ) during startup. Otherwise, $\overline{\text{RESET}}$ only considers step-down converter output voltage for its high impedance state. Refer to the MAX17671 IC data sheet for more information.

Table 1. Step-Down Converter Enable (EN/UVLO) Description (JU1)

SHUNT POSITION	EN/UVLO PIN	OUTPUT
Not installed*	Connected to the center node of resistor-divider R1 and R2	Enabled, UVLO level set through the R1 and R2 resistors
1-2	Connected to GND	Disabled

*Default position.

Table 2. MODE/SYNC Description (JU2)

SHUNT POSITION	MODE/SYNC PIN	MODE
1-2	Connected to GND	PWM Mode of operation
Not installed*	Unconnected	PFM Mode of operation

*Default position.

MAX17671FEVKIT# Evaluation Kit

Evaluates: MAX17671 5V Step-Down Converter and 3.3V Linear Regulator Output Voltage Application

MAX17671F EV Kit Performance Report

($V_{IN} = 24V$, unless otherwise noted.)

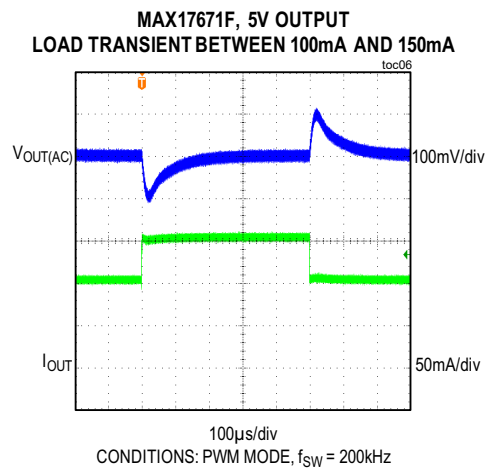
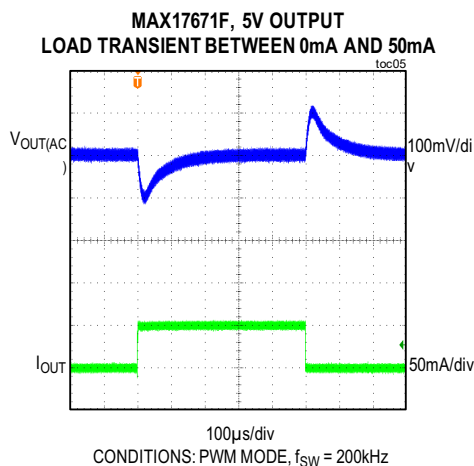
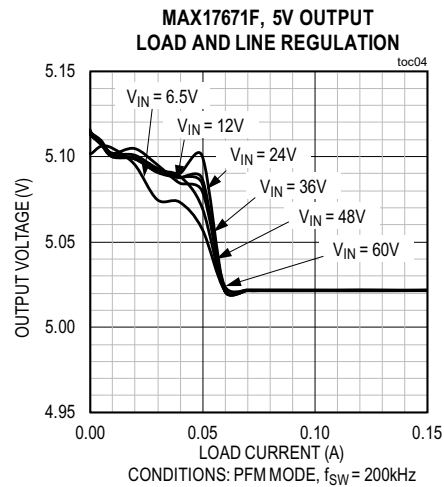
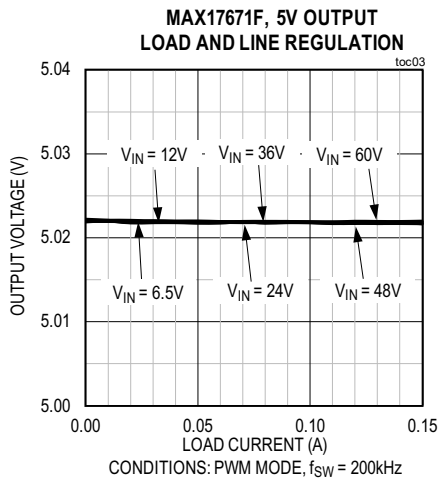
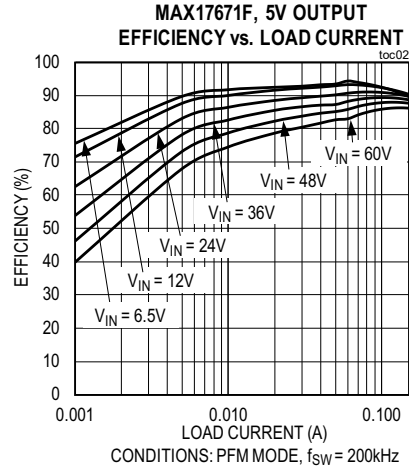
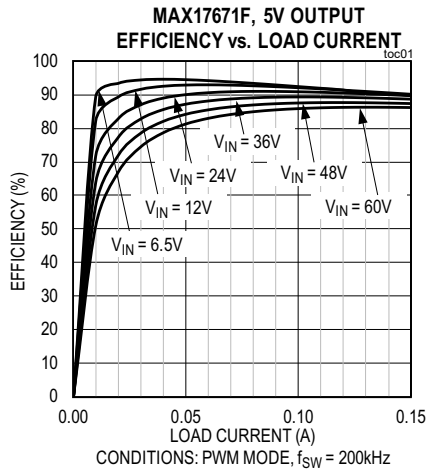

MAX17671FEVKIT#
Evaluation Kit

Evaluates: MAX17671 5V Step-Down
Converter and 3.3V Linear Regulator
Output Voltage Application

MAX17671F EV Kit Performance Report (continued)

($V_{IN} = 24V$, unless otherwise noted.)

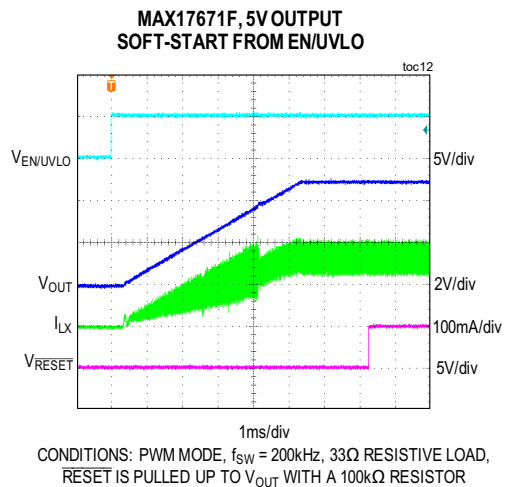
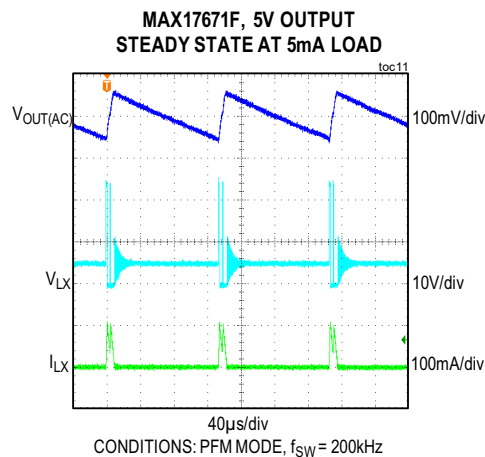
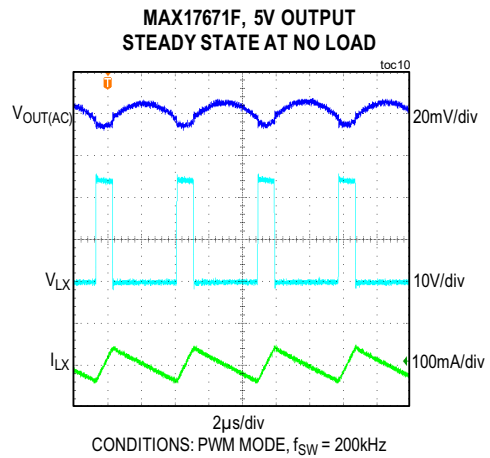
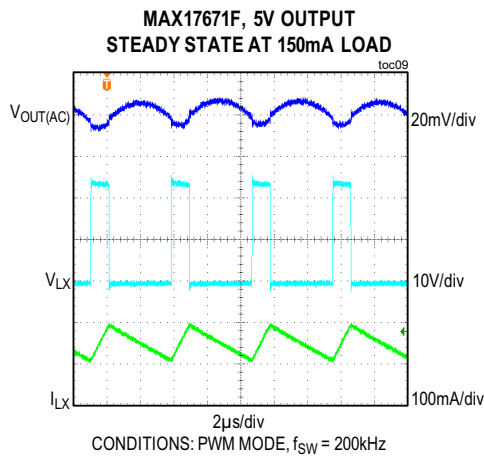
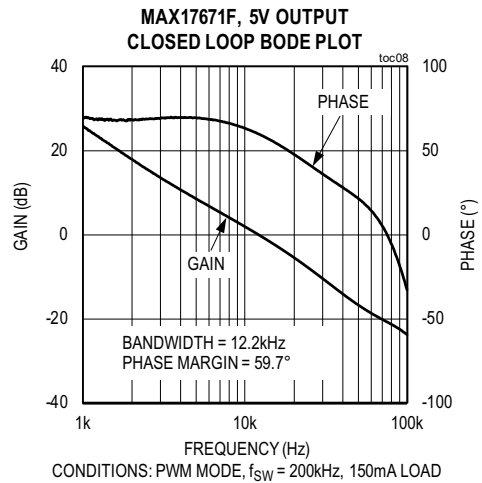
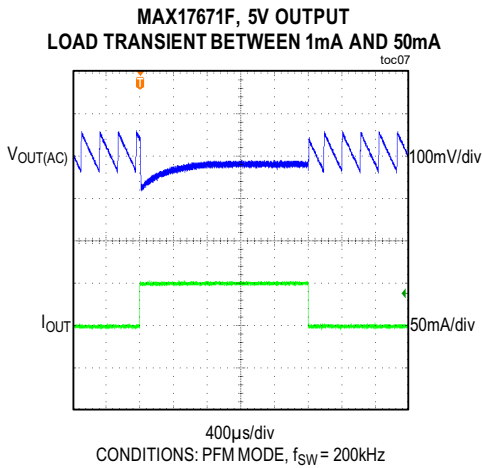

MAX17671FEVKIT# Evaluation Kit

Evaluates: MAX17671 5V Step-Down Converter and 3.3V Linear Regulator Output Voltage Application

MAX17671F EV Kit Performance Report (continued)

($V_{IN} = 24V$, unless otherwise noted.)

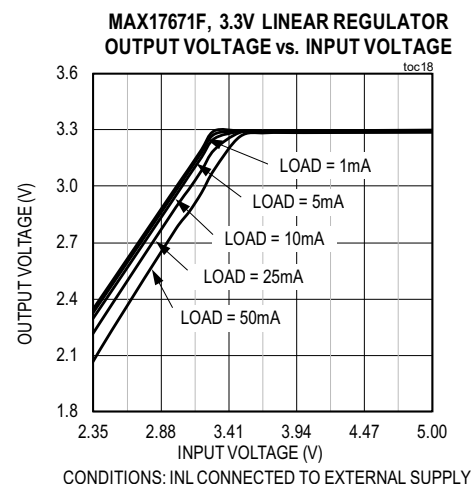
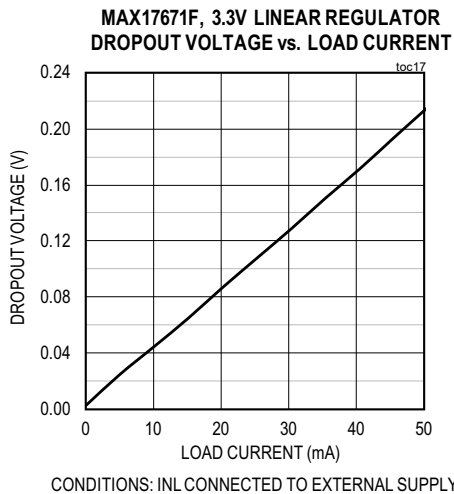
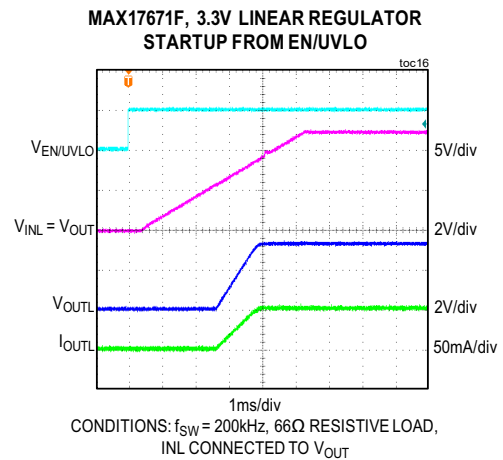
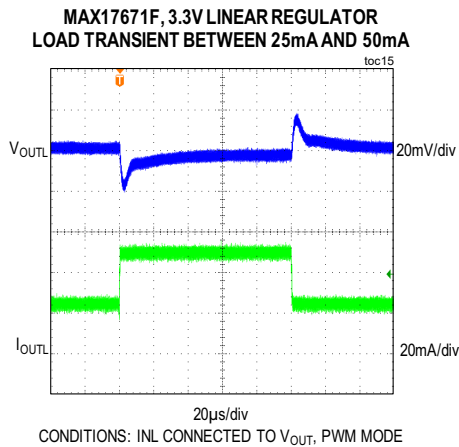
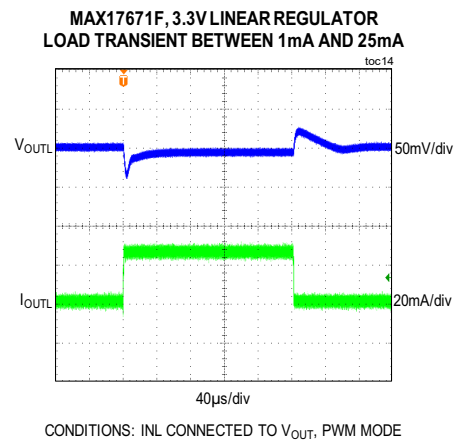
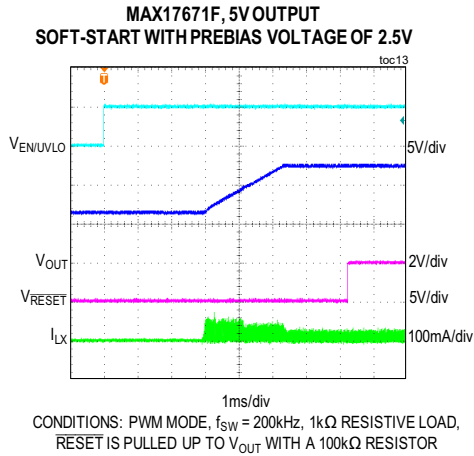

MAX17671FEVKIT# Evaluation Kit

Evaluates: MAX17671 5V Step-Down Converter and 3.3V Linear Regulator Output Voltage Application

MAX17671F EV Kit Performance Report (continued)

($V_{IN} = 24V$, unless otherwise noted.)

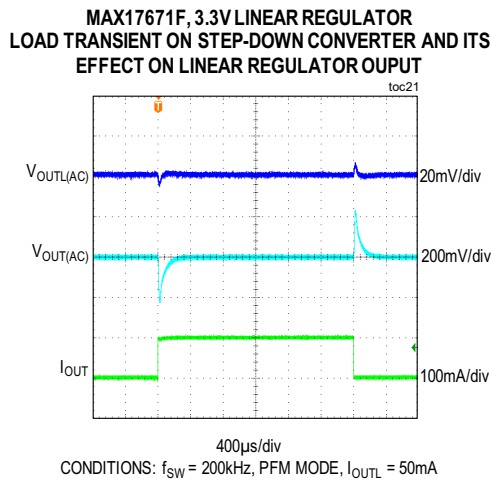
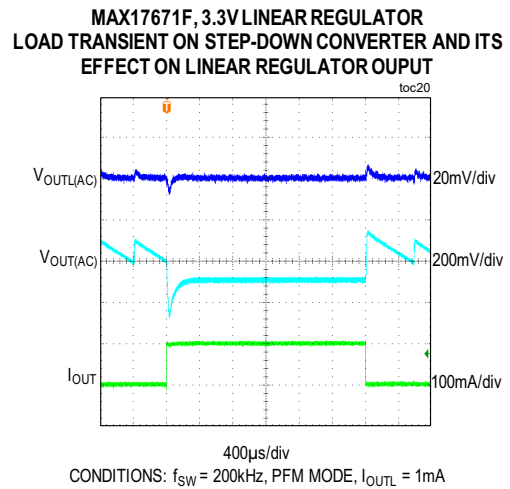
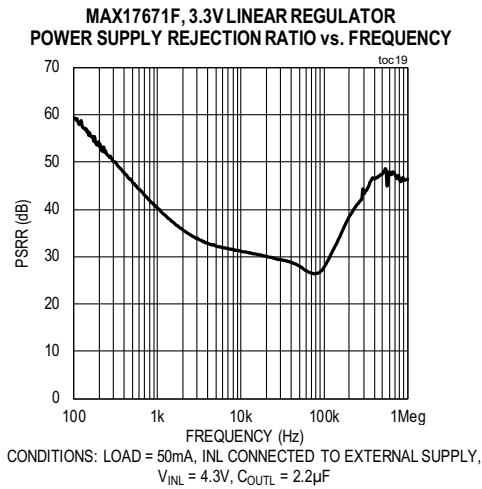

MAX17671FEVKIT#
Evaluation Kit

Evaluates: MAX17671 5V Step-Down
Converter and 3.3V Linear Regulator
Output Voltage Application

Component Suppliers

SUPPLIER	WEBSITE
Coilcraft, Inc.	www.coilcraft.com
Murata Americas	www.murataamericas.com
Panasonic Corp.	www.panasonic.com

Note: Indicate that you are using the MAX17671 when contacting these component suppliers.

Ordering Information

PART	TYPE
MAX17671FEVKIT#	EVKIT

MAX17671FEVKIT#
Evaluation Kit

Evaluates: MAX17671 5V Step-Down
Converter and 3.3V Linear Regulator
Output Voltage Application

MAX17671F EV Kit System Bill of Materials

NO.	DESCRIPTION	QUANTITY	DESIGNATOR	PART NUMBER
1	1 μ F, 10%, 100V, X7R,Ceramic capacitor (1206)	1	C1	MURATA GRM31CR72A105KA01L
2	2.2 μ F, 10%, 10V, X7R,Ceramic capacitor (0603)	1	C2	MURATA GRM188R71A225KE15
3	10 μ F, 10%, 25V, X7R,Ceramic capacitor (0805)	1	C4	MURATA GRM21BZ71E106KE15
4	22 μ F, 20%, 100V, Electrolytic capacitor	1	C5	PANASONIC EEE-TG2A220UP
5	2-pin header (36-pin header 0.1" centers)	2	JU1, JU2	SULLINS PEC02SAAN
6	INDUCTOR, 220 μ H, 0.64A	1	L1	COILCRAFT LPS6235-224ML
7	3.32M Ω , \pm 1%, 1/10W, resistor (0402)	1	R1	Any
8	787k Ω , \pm 1%, 1/10W, resistor (0402)	1	R2	Any
9	0 Ω , \pm 5%, 1/16W, resistor (0402)	2	R3, R7	Any
10	274k Ω , \pm 1%, 1/10W, resistor (0402)	1	R5	Any
11	100k Ω , \pm 1%, 1/16W, resistor (0402)	1	R6	Any
12	Integrated Step-down Converter with a Linear Regulator, MAX17671F	1	U1	MAXIM MAX17671FATB+

Jumper Table	
Jumper	Shunt Position
JU1, JU2	Open

MAX17671FEVKIT#
Evaluation Kit

Evaluates: MAX17671 5V Step-Down
Converter and 3.3V Linear Regulator
Output Voltage Application

MAX17671F EV Kit System Schematic

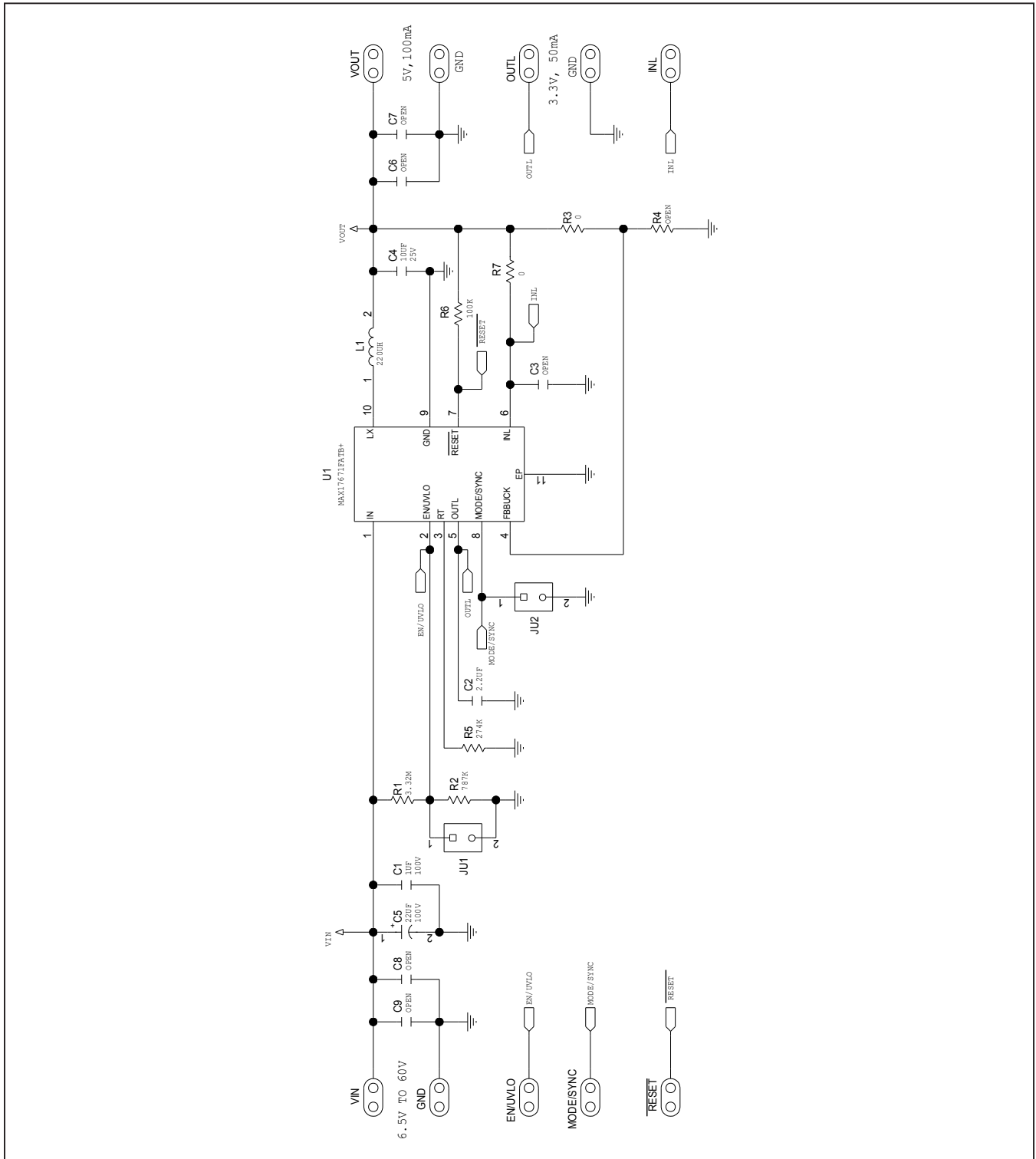

MAX17671FEVKIT#
Evaluation Kit

Evaluates: MAX17671 5V Step-Down
Converter and 3.3V Linear Regulator
Output Voltage Application

MAX17671F EV Kit System PCB Layout

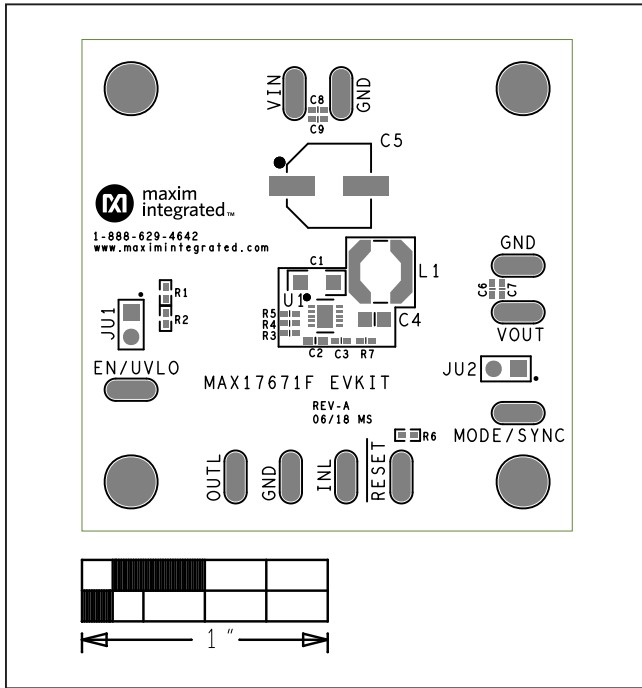

MAX17671F EV Kit—Top Silkscreen

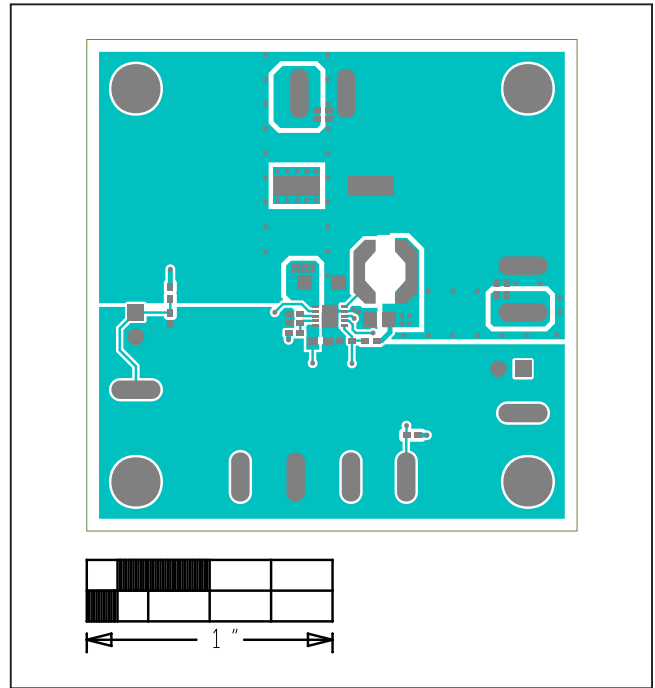

MAX17671F EV Kit—Top Layer

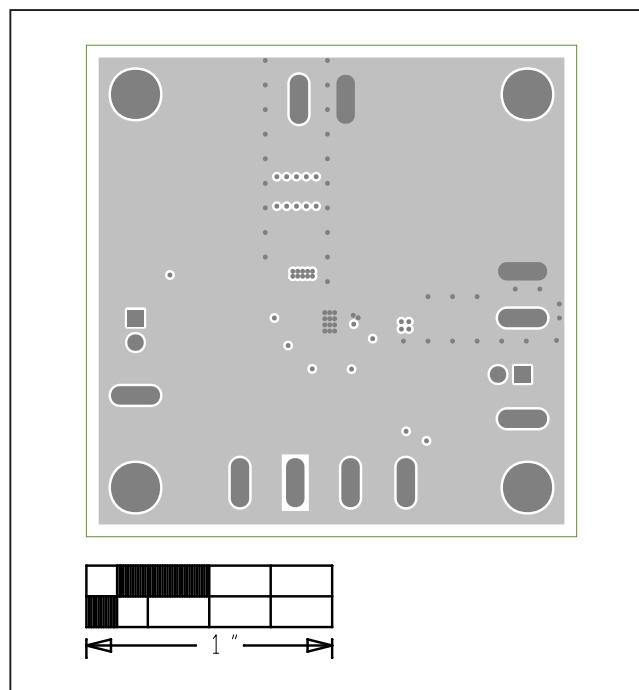

MAX17671F EV Kit—Layer 2

MAX17671FEVKIT#
Evaluation Kit

Evaluates: MAX17671 5V Step-Down
Converter and 3.3V Linear Regulator
Output Voltage Application

MAX17671F EV Kit System PCB Layout (continued)

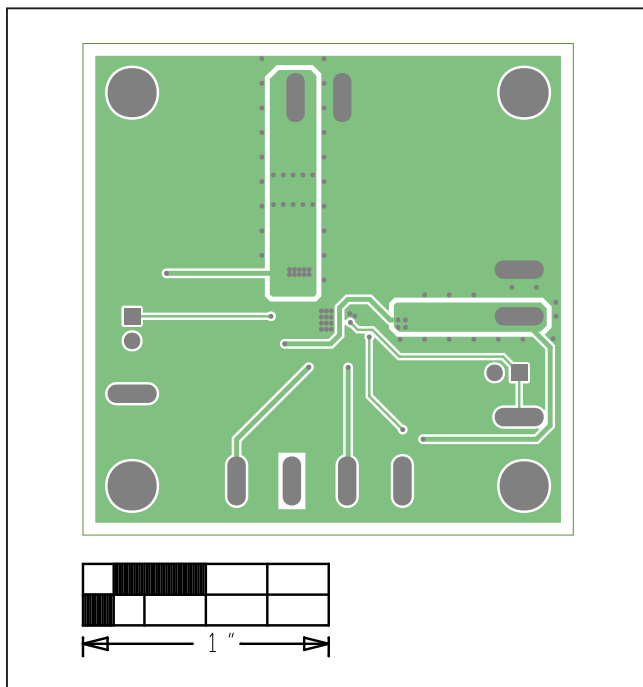

MAX17671F EV Kit—Layer 3

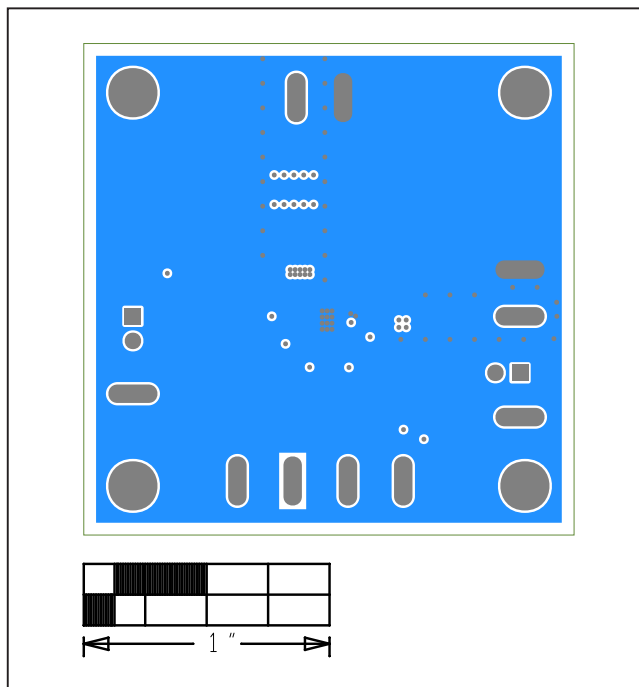

MAX17671F EV Kit—Bottom Layer

MAX17671FEVKIT#
Evaluation Kit

Evaluates: MAX17671 5V Step-Down
Converter and 3.3V Linear Regulator
Output Voltage Application

Revision History

REVISION NUMBER	REVISION DATE	DESCRIPTION	PAGES CHANGED
0	7/18	Initial release	—
0.1		Corrected missing overbar on $\overline{\text{RESET}}$.	1

For pricing, delivery, and ordering information, please visit Maxim Integrated's online storefront at <https://www.maximintegrated.com/en/storefront/storefront.html>.

Maxim Integrated cannot assume responsibility for use of any circuitry other than circuitry entirely embodied in a Maxim Integrated product. No circuit patent licenses are implied. Maxim Integrated reserves the right to change the circuitry and specifications without notice at any time.



Компания «ЭлектроПласт» предлагает заключение долгосрочных отношений при поставках импортных электронных компонентов на взаимовыгодных условиях!

Наши преимущества:

- Оперативные поставки широкого спектра электронных компонентов отечественного и импортного производства напрямую от производителей и с крупнейших мировых складов;
- Поставка более 17-ти миллионов наименований электронных компонентов;
- Поставка сложных, дефицитных, либо снятых с производства позиций;
- Оперативные сроки поставки под заказ (от 5 рабочих дней);
- Экспресс доставка в любую точку России;
- Техническая поддержка проекта, помощь в подборе аналогов, поставка прототипов;
- Система менеджмента качества сертифицирована по Международному стандарту ISO 9001;
- Лицензия ФСБ на осуществление работ с использованием сведений, составляющих государственную тайну;
- Поставка специализированных компонентов (Xilinx, Altera, Analog Devices, Intersil, Interpoint, Microsemi, Aeroflex, Peregrine, Syfer, Eurofarad, Texas Instrument, Miteq, Cobham, E2V, MA-COM, Hittite, Mini-Circuits, General Dynamics и др.);

Помимо этого, одним из направлений компании «ЭлектроПласт» является направление «Источники питания». Мы предлагаем Вам помощь Конструкторского отдела:

- Подбор оптимального решения, техническое обоснование при выборе компонента;
- Подбор аналогов;
- Консультации по применению компонента;
- Поставка образцов и прототипов;
- Техническая поддержка проекта;
- Защита от снятия компонента с производства.



Как с нами связаться

Телефон: 8 (812) 309 58 32 (многоканальный)

Факс: 8 (812) 320-02-42

Электронная почта: org@eplast1.ru

Адрес: 198099, г. Санкт-Петербург, ул. Калинина, дом 2, корпус 4, литера А.