

# Power Entry Modules

*The industry's most complete line of power entry modules are ideal for products that must conform to FCC Part 15 regulations. These metal cased miniature filters offer high performance.*



|   |           |
|---|-----------|
| Bolt-in Rear Terminals .....                      | PF16-PF17 |
| For General Purpose Applications .....            | PF22-PF23 |
| For Medical Applications .....                    | PF24-PF25 |
| Bolt-in Right Angle Terminals .....               | PF18-PF19 |
| For PCB Applications .....                        | PF46-PF47 |
| High Frequency Attenuation .....                  | PF20-PF21 |
| Bolt-in for PCB Applications .....                | PF48-PF49 |
| Snap-in with Wire Leads .....                     | PF26-PF27 |
| Bolt-in with Wire Leads .....                     | PF28-PF31 |
| Snap-in Mount .....                               | PF32-PF33 |
| Fused Filtered .....                              | PF34-PF37 |
| For General Purpose Applications .....            | PF34-PF35 |
| For Medical or General Purpose Applications ..... | PF36-PF37 |
| Switched and Fused Filtered .....                 | PF38-PF43 |
| PCB Power Filters .....                           | PF44-PF45 |

# Power Entry Modules Bolt-in Rear Terminals

## 60-BPR & BPS Series

### Features

- Ideally suited for products that must conform to FCC part 15 regulations
- Metal case offers high performance
- Meets over voltage of IEC 664 category II and complies with IEC 950
- Uses IEC connector that meets most safety standards
- Solder lug and Fast-on tab terminals available
- Operating temperature: -25°C to +85°C (including temperature rise, see graph on page PF17)
- UL approved low leakage version also available

### Applications

- Digital equipment
- Personal computers and peripherals
- Measuring instruments
- Monitor and display units



Tested and found to be IAW VDE 0565 Part 3.



### Circuit Diagram



### Specifications

| Model*          | Rated Voltage (@ 50/60Hz) | Rated Current | Leakage Current (Max.) | Capacitance    |                | Inductance (L <sub>1</sub> ) | Temperature Rise (Max.) |              |
|-----------------|---------------------------|---------------|------------------------|----------------|----------------|------------------------------|-------------------------|--------------|
|                 |                           |               |                        | C <sub>Y</sub> | C <sub>X</sub> |                              |                         |              |
| 60-XXX-010-3-2  | 250VAC                    | 1A            | 0.35mA                 | 2200pF ± 20%   | .022uF ± 20%   | 6.0mH                        | 30°C                    |              |
| 60-XXX-010-3-4  |                           |               |                        |                | .047uF ± 20%   |                              |                         |              |
| 60-XXX-010-5-2  |                           |               | 0.50mA                 |                | 3300pF ± 20%   |                              |                         | .022uF ± 20% |
| 60-XXX-010-5-4  |                           |               |                        |                |                |                              |                         | .047uF ± 20% |
| 60-XXX-020-3-2  | 250VAC                    | 2A            | 0.35mA                 | 2200pF ± 20%   | .022uF ± 20%   | 2.4mH                        | 30°C                    |              |
| 60-XXX-020-3-4  |                           |               |                        |                | .047uF ± 20%   |                              |                         |              |
| 60-XXX-020-5-2  |                           |               | 0.50mA                 |                | 3300pF ± 20%   |                              |                         | .022uF ± 20% |
| 60-XXX-020-5-4  |                           |               |                        |                |                |                              |                         | .047uF ± 20% |
| 60-XXX-030-3-2  | 250VAC                    | 3A            | 0.35mA                 | 2200pF ± 20%   | .022uF ± 20%   | 1.2mH                        | 30°C                    |              |
| 60-XXX-030-3-4  |                           |               |                        |                | .047uF ± 20%   |                              |                         |              |
| 60-XXX-030-5-2  |                           |               | 0.50mA                 |                | 3300pF ± 20%   |                              |                         | .022uF ± 20% |
| 60-XXX-030-5-4  |                           |               |                        |                |                |                              |                         | .047uF ± 20% |
| 60-XXX-060-3-2  | 250VAC                    | 6A            | 0.35mA                 | 2200pF ± 20%   | .022uF ± 20%   | 0.53mH                       | 45°C                    |              |
| 60-XXX-060-3-4  |                           |               |                        |                | .047uF ± 20%   |                              |                         |              |
| 60-XXX-060-5-2  |                           |               | 0.50mA                 |                | 3300pF ± 20%   |                              |                         | .022uF ± 20% |
| 60-XXX-060-5-4  |                           |               |                        |                |                |                              |                         | .047uF ± 20% |
| 60-XXX-100-3-2  | 250VAC                    | 10A           | 0.35mA                 | 2200pF ± 20%   | .022uF ± 20%   | 0.26mH                       | 45°C                    |              |
| 60-XXX-100-5-2  |                           |               | 0.50mA                 |                |                |                              |                         | 3300pF ± 20% |
| 60-BPR-150-3-11 | 250VAC                    | 15A           | 0.35mA                 | 2200pF ± 20%   | .1uF ± 20%     | 0.15mH                       | 45°C                    |              |

Note: Test voltage: 1500VAC one minute, line to ground  
 Insulation resistance: 300 Mohm min. at 500VDC  
 Voltage drop: 1V max. at rated current  
 Weight: 45g  
 Input: Compatible with IEC-320

\* Substitute BPR or BPS for XXX

BPS - Solder lug terminals  
 BPR - Fast-on tab terminals

# Power Entry Modules Bolt-in Rear Terminals

## 60-BPR & BPS Series



# Power Entry Modules Bolt-in Right Angle Terminals



## 60-BPF Series

### Features

- Ideally suited for products that must conform to FCC part 15 regulations
- Metal case offers high performance
- Meets over voltage of IEC 664 category II and complies with IEC 950
- Uses IEC connector that meets most safety standards
- PCB mounting types available (see page PF46)
- Length under tab is shortened for small spaces
- Operating temperature: -25°C to +85°C (including temperature rise, see graph on page PF19)
- UL approved low leakage version also available



Tested and found to be IAW VDE 0565 Part 3.

### Applications

- Digital equipment
- Personal computers and peripherals
- Measuring instruments
- Monitor and display units

### Circuit Diagram



### Specifications

| Model          | Rated Voltage (@ 50/60Hz) | Rated Current | Leakage Current (Max.) | Capacitance    |                | Inductance (L <sub>1</sub> ) | Temperature Rise (Max.) |
|----------------|---------------------------|---------------|------------------------|----------------|----------------|------------------------------|-------------------------|
|                |                           |               |                        | C <sub>Y</sub> | C <sub>X</sub> |                              |                         |
| 60-BPF-010-3-2 | 250VAC                    | 1A            | 0.35mA                 | 2200pF ± 20%   | .022uF ± 20%   | 6.0mH                        | 30°C                    |
| 60-BPF-010-3-4 |                           |               |                        |                | .047uF ± 20%   |                              |                         |
| 60-BPF-010-5-2 |                           |               | 0.50mA                 | 3300pF ± 20%   | .022uF ± 20%   |                              |                         |
| 60-BPF-010-5-4 |                           |               |                        |                | .047uF ± 20%   |                              |                         |
| 60-BPF-020-3-2 | 250VAC                    | 2A            | 0.35mA                 | 2200pF ± 20%   | .022uF ± 20%   | 2.4mH                        | 30°C                    |
| 60-BPF-020-3-4 |                           |               |                        |                | .047uF ± 20%   |                              |                         |
| 60-BPF-020-5-2 |                           |               | 0.50mA                 | 3300pF ± 20%   | .022uF ± 20%   |                              |                         |
| 60-BPF-020-5-4 |                           |               |                        |                | .047uF ± 20%   |                              |                         |
| 60-BPF-030-3-2 | 250VAC                    | 3A            | 0.35mA                 | 2200pF ± 20%   | .022uF ± 20%   | 1.2mH                        | 30°C                    |
| 60-BPF-030-3-4 |                           |               |                        |                | .047uF ± 20%   |                              |                         |
| 60-BPF-030-5-2 |                           |               | 0.50mA                 | 3300pF ± 20%   | .022uF ± 20%   |                              |                         |
| 60-BPF-030-5-4 |                           |               |                        |                | .047uF ± 20%   |                              |                         |
| 60-BPF-060-3-2 | 250VAC                    | 6A            | 0.35mA                 | 2200pF ± 20%   | .022uF ± 20%   | 0.53mH                       | 45°C                    |
| 60-BPF-060-3-4 |                           |               |                        |                | .047uF ± 20%   |                              |                         |
| 60-BPF-060-5-2 |                           |               | 0.50mA                 | 3300pF ± 20%   | .022uF ± 20%   |                              |                         |
| 60-BPF-060-5-4 |                           |               |                        |                | .047uF ± 20%   |                              |                         |

Note: Test voltage: 1500VAC one minute, line to ground  
 Insulation resistance: 300 Mohm min. at 500VDC  
 Voltage drop: 1V max. at rated current  
 Weight: 50g  
 Input: Compatible with IEC-320

# Power Entry Modules Bolt-in Right Angle Terminals

## 60-BPF Series

### Temperature Characteristics



### 60-BPF Fast-on Terminals



Dimensions in inches (mm)

### Common Mode



#### 60-BPF-010;-020



#### 60-BPF-030;-060



### Normal Mode



#### 60-BPF-010;-020



#### 60-BPF-030;-060



# Power Entry Modules High Frequency Attenuation



## 60-BHS Series



Tested and found to be  
IAW VDE 0565 Part 3.

### Features

- Ideally suited for products that must conform to FCC part 15 regulations
- Metal cased miniature filter offers high performance
- Meets over voltage of IEC 664 category II and complies with IEC 950
- PCB mounting types available (see page PF48)
- PCB mounting minimizes space and provides economical installation
- Excellent filtering characteristics for high frequencies
- Earth coil standard
- Operating temperature: -25°C to +85°C (including temperature rise, see graph on page PF21)

### Applications

- Digital equipment
- Personal computers and peripherals
- Measuring instruments
- Monitor and display units

### Circuit Diagram



### Specifications

| Model           | Rated Voltage<br>(@ 50/60Hz) | Rated Current | Leakage Current<br>(Max.) | Capacitance    |                | Inductance        |                   | Temperature Rise (Max.) |
|-----------------|------------------------------|---------------|---------------------------|----------------|----------------|-------------------|-------------------|-------------------------|
|                 |                              |               |                           | C <sub>Y</sub> | C <sub>X</sub> | (L <sub>1</sub> ) | (L <sub>2</sub> ) |                         |
| 60-BHS-010-3-11 | 250VAC                       | 1A            | 0.35mA                    | 2200pF ± 20%   | 0.1uF ± 20%    | 6mH               | 18.3uH            | 30°C                    |
| 60-BHS-010-3-4  |                              |               |                           |                | .047uF ± 20%   |                   |                   |                         |
| 60-BHS-010-5-11 |                              |               | 0.50mA                    | 3300pF ± 20%   | 0.1uF ± 20%    |                   |                   |                         |
| 60-BHS-010-5-4  |                              |               |                           |                | .047uF ± 20%   |                   |                   |                         |
| 60-BHS-020-3-11 | 250VAC                       | 2A            | 0.35mA                    | 2200pF ± 20%   | 0.1uF ± 20%    | 2.4mH             | 18.3uH            | 30°C                    |
| 60-BHS-020-3-4  |                              |               |                           |                | .047uF ± 20%   |                   |                   |                         |
| 60-BHS-020-5-11 |                              |               | 0.50mA                    | 3300pF ± 20%   | 0.1uF ± 20%    |                   |                   |                         |
| 60-BHS-020-5-4  |                              |               |                           |                | .047uF ± 20%   |                   |                   |                         |
| 60-BHS-030-3-11 | 250VAC                       | 3A            | 0.35mA                    | 2200pF ± 20%   | 0.1uF ± 20%    | 1.2mH             | 18.3uH            | 30°C                    |
| 60-BHS-030-3-4  |                              |               |                           |                | .047uF ± 20%   |                   |                   |                         |
| 60-BHS-030-5-11 |                              |               | 0.50mA                    | 3300pF ± 20%   | 0.1uF ± 20%    |                   |                   |                         |
| 60-BHS-030-5-4  |                              |               |                           |                | .047uF ± 20%   |                   |                   |                         |
| 60-BHS-060-3-11 | 250VAC                       | 6A            | 0.35mA                    | 2200pF ± 20%   | 0.1uF ± 20%    | .53mH             | 18.3uH            | 45°C                    |
| 60-BHS-060-3-4  |                              |               |                           |                | .047uF ± 20%   |                   |                   |                         |
| 60-BHS-060-5-11 |                              |               | 0.50mA                    | 3300pF ± 20%   | 0.1uF ± 20%    |                   |                   |                         |
| 60-BHS-060-5-4  |                              |               |                           |                | .047uF ± 20%   |                   |                   |                         |

Note: Test voltage: 1500VAC one minute, line to ground  
 Insulation resistance: 300 Mohm min. at 500VDC  
 Voltage drop: 1V max. at rated current  
 Weight: 50g  
 Input: Compatible with IEC-320

# Power Entry Modules High Frequency Attenuation

## 60-BHS Series



# Power Entry Modules Bolt-in Rear Terminals

For General Purpose Applications



## 10-BPF Series



### Features

- Ideally suited for products that must conform to FCC part 15 regulations
- Metal case offers high performance
- Meets over voltage of IEC 664 category II and complies with IEC 950
- Uses IEC connector that meets most safety standards
- Operating temperature: -25°C to +70°C
- Compact configuration

### Applications

- Digital equipment
- Personal computers and peripherals
- Measuring instruments
- Monitor and display units

### Circuit Diagram



### Specifications

| Model          | Rated Voltage (@ 50/60Hz) | Rated Current | Leakage Current (Max.) | Capacitance     |                 | Inductance (L <sub>1</sub> ) | Circuit Diagram | Figure          | Temperature Rise (Max.) |
|----------------|---------------------------|---------------|------------------------|-----------------|-----------------|------------------------------|-----------------|-----------------|-------------------------|
|                |                           |               |                        | C <sub>Y</sub>  | C <sub>X</sub>  |                              |                 |                 |                         |
| 10-BPF-001-5-A | 120/250VAC                | 1A            | 0.50mA                 | 3300pF          | 2200pF          | 3.0mH                        | 1               | A               | 30°C                    |
| 10-BPF-001-5-C |                           |               |                        |                 |                 |                              |                 | C               |                         |
| 10-BPF-003-5-A |                           | 3A            |                        | 4700pF          | 0.01uF          | 1.5mH                        | 2               | A               |                         |
| 10-BPF-003-5-C |                           |               |                        |                 |                 |                              |                 | C               |                         |
| 10-BPF-003-5-D |                           | 6A            |                        | 3300pF          | 0.5mH           | 1                            | A               |                 |                         |
| 10-BPF-006-5-A |                           |               |                        |                 |                 |                              | C               |                 |                         |
| 10-BPF-006-5-C |                           | 10A           |                        | 3300pF & 0.01uF | 3300pF & 0.01uF | 1.5mH                        | 2               | B               |                         |
| 10-BPF-006-5-D |                           |               |                        |                 |                 |                              |                 | B               |                         |
| 10-BPF-010-5-A |                           | 3300pF        |                        | 0.01uF          | 0.5mH           | 1                            | A               |                 |                         |
| 10-BPF-010-5-D |                           |               |                        |                 |                 |                              | 3300pF & 0.01uF | 3300pF & 0.01uF |                         |

Note: Test voltage: 1500VAC one minute, line to ground  
 Insulation resistance: 300 Mohm min. at 500VDC  
 Voltage drop: 1V max. at rated current  
 Weight: 45g  
 Input: Compatible with IEC-320



# Power Entry Modules Bolt-in Rear Terminals For General Purpose Applications

## 10-BPF Series

**Figure A**



**Figure B**



**Figure C**



Dimensions in inches (mm)

### Common Mode



#### 10-BPF-001;-003



#### 10-BPF-006;-010



### Normal Mode



#### 10-BPF-001;-003



#### 10-BPF-006;-010



# Power Entry Modules Bolt-in Rear Terminals

For Medical Purpose Applications



## 10-BPF Series



### Features

- Ideally suited for products that must conform to FCC part 15 regulations
- Metal case offers high performance
- Meets over voltage of IEC 664 category II and complies with IEC 950
- Uses IEC connector that meets most safety standards
- Operating temperature: -25°C to +70°C
- Compact configuration
- Low leakage current

### Applications

- Digital equipment
- Personal computers and peripherals
- Measuring instruments
- Monitor and display units

### Circuit Diagram



### Specifications

| Model          | Rated Voltage (@ 50/60Hz) | Rated Current | Leakage Current (Max.) | Capacitance C <sub>x</sub> | Inductance (L <sub>1</sub> ) | Circuit Diagram | Figure | Temperature Rise (Max.) |
|----------------|---------------------------|---------------|------------------------|----------------------------|------------------------------|-----------------|--------|-------------------------|
| 10-BPF-001-2-A | 120/250VAC                | 1A            | 5uA                    | 0.01uF                     | 3.0mH                        | 1               | A      | 30°C                    |
| 10-BPF-003-2-A |                           | 3A            |                        |                            | 1.5mH                        |                 |        |                         |
| 10-BPF-006-2-A |                           | 6A            |                        |                            | 0.5mH                        |                 |        |                         |

Note: Test voltage: 1500VAC one minute, line to ground  
 Insulation resistance: 300 Mohm min. at 500VDC  
 Voltage drop: 1V max. at rated current  
 Weight: 45g  
 Input: Compatible with IEC-320

# Power Entry Modules Bolt-in Rear Terminals For Medical Purpose Applications

## 10-BPF Series



Dimensions in inches (mm)



### Common Mode



#### 10-BPF-001;-003;-006



### Normal Mode



#### 10-BPF-001;-003;-006



# Power Entry Modules Snap-in with Wire Leads



## 60-SPL Series

### Features

- Ideally suited for products that must conform to FCC part 15 regulations
- Metal cased miniature filter offers high performance
- Meets over voltage of IEC 664 category II and complies with IEC 950
- Uses IEC connector that meets most safety standards
- Snap-in style saves labor and hardware inventory
- Wire output minimizes space and provides economical installation
- Operating temperature: -25°C to +85°C (including temperature rise, see graph on page PF27)



Tested and found to be IAW VDE 0565 Part 3.

### Applications

- Digital equipment
- Personal computers and peripherals
- Measuring instruments
- Monitor and display units

### Circuit Diagram



### Specifications

| Model          | Rated Voltage (@ 50/60Hz) | Rated Current | Leakage Current (Max.) | Capacitance    |                | Inductance (L <sub>1</sub> ) | Temperature Rise (Max.) |              |
|----------------|---------------------------|---------------|------------------------|----------------|----------------|------------------------------|-------------------------|--------------|
|                |                           |               |                        | C <sub>Y</sub> | C <sub>X</sub> |                              |                         |              |
| 60-SPL-010-3-2 | 250VAC                    | 1A            | 0.35mA                 | 2200pF ± 20%   | 22nF ± 20%     | 6.0mH                        | 30°C                    |              |
| 60-SPL-010-3-3 |                           |               |                        |                | 33nF ± 20%     |                              |                         |              |
| 60-SPL-010-5-2 |                           |               | 0.50mA                 | 3300pF ± 20%   | 22nF ± 20%     |                              |                         |              |
| 60-SPL-010-5-3 |                           |               |                        |                | 33nF ± 20%     |                              |                         |              |
| 60-SPL-020-3-2 | 250VAC                    | 2A            | 0.35mA                 | 2200pF ± 20%   | 22nF ± 20%     | 2.4mH                        | 30°C                    |              |
| 60-SPL-020-3-3 |                           |               |                        |                | 33nF ± 20%     |                              |                         |              |
| 60-SPL-020-5-2 |                           |               | 0.50mA                 | 3300pF ± 20%   | 22nF ± 20%     |                              |                         |              |
| 60-SPL-020-5-3 |                           |               |                        |                | 33nF ± 20%     |                              |                         |              |
| 60-SPL-030-3-2 | 250VAC                    | 3A            | 0.35mA                 | 2200pF ± 20%   | .022uF ± 20%   | 1.2mH                        | 30°C                    |              |
| 60-SPL-030-3-3 |                           |               |                        | 3300pF ± 20%   |                |                              |                         |              |
| 60-SPL-030-5-2 |                           |               | 0.50mA                 | 2200pF ± 20%   | 3300pF ± 20%   |                              |                         | .033uF ± 20% |
| 60-SPL-030-5-3 |                           |               |                        |                |                |                              |                         |              |
| 60-SPL-060-3-2 | 250VAC                    | 6A            | 0.35mA                 | 2200pF ± 20%   | 22nF ± 20%     | 0.53mH                       | 45°C                    |              |
| 60-SPL-060-3-3 |                           |               |                        |                | 33nF ± 20%     |                              |                         |              |
| 60-SPL-060-5-2 |                           |               | 0.50mA                 | 3300pF ± 20%   | 22nF ± 20%     |                              |                         |              |
| 60-SPL-060-5-3 |                           |               |                        |                |                |                              |                         | 33nF ± 20%   |

Note: Test voltage: 1500VAC one minute, line to ground  
 Insulation resistance: 300 Mohm min. at 500VDC  
 Voltage drop: 1V max. at rated current  
 Weight: 50g  
 Input: Compatible with IEC-320

# Power Entry Modules Snap-in with Wire Leads

## 60-SPL Series



# Power Entry Modules Bolt-in with Wire Leads



## 60-BPL Series

### Features

- Ideally suited for products that must conform to FCC part 15 regulations
- Metal case filter offers high performance
- Meets over voltage of IEC 664 category II and complies with IEC 950
- Uses IEC connector that meets most safety standards
- Wire output for minimizing space use and economical installation
- Operating temperature: -25°C to +85°C (including temperature rise, see graph on page PF28)



Tested and found to be IAW VDE 0565 Part 3.

### Applications

- Digital equipment
- Personal computers and peripherals
- Measuring instruments
- Monitor and display units

### Circuit Diagram



### Specifications

| Model          | Rated Voltage (@ 50/60Hz) | Rated Current | Leakage Current (Max.) | Capacitance    |                | Inductance (L <sub>1</sub> ) | Temperature Rise (Max.) |              |
|----------------|---------------------------|---------------|------------------------|----------------|----------------|------------------------------|-------------------------|--------------|
|                |                           |               |                        | C <sub>Y</sub> | C <sub>X</sub> |                              |                         |              |
| 60-BPL-010-3-2 | 250VAC                    | 1A            | 0.35mA                 | 2200pF ± 20%   | 22nF ± 20%     | 6.0mH                        | 30°C                    |              |
| 60-BPL-010-3-3 |                           |               |                        |                | 33nF ± 20%     |                              |                         |              |
| 60-BPL-010-5-2 |                           |               | 0.50mA                 | 3300pF ± 20%   | 22nF ± 20%     |                              |                         |              |
| 60-BPL-010-5-3 |                           |               |                        |                | 33nF ± 20%     |                              |                         |              |
| 60-BPL-020-3-2 | 250VAC                    | 2A            | 0.35mA                 | 2200pF ± 20%   | 22nF ± 20%     | 2.4mH                        | 30°C                    |              |
| 60-BPL-020-3-3 |                           |               |                        |                | 33nF ± 20%     |                              |                         |              |
| 60-BPL-020-5-2 |                           |               | 0.50mA                 | 3300pF ± 20%   | 22nF ± 20%     |                              |                         |              |
| 60-BPL-020-5-3 |                           |               |                        |                | 33nF ± 20%     |                              |                         |              |
| 60-BPL-030-3-2 | 250VAC                    | 3A            | 0.35mA                 | 2200pF ± 20%   | .022uF ± 20%   | 1.2mH                        | 30°C                    |              |
| 60-BPL-030-3-3 |                           |               |                        | 3300pF ± 20%   |                |                              |                         |              |
| 60-BPL-030-5-2 |                           |               | 0.50mA                 | 3300pF ± 20%   | 2200pF ± 20%   |                              |                         | .033uF ± 20% |
| 60-BPL-030-5-3 |                           |               |                        |                | 3300pF ± 20%   |                              |                         |              |
| 60-BPL-060-3-2 | 250VAC                    | 6A            | 0.35mA                 | 2200pF ± 20%   | 22nF ± 20%     | 0.53mH                       | 45°C                    |              |
| 60-BPL-060-3-3 |                           |               |                        |                | 33nF ± 20%     |                              |                         |              |
| 60-BPL-060-5-2 |                           |               | 0.50mA                 | 3300pF ± 20%   | 22nF ± 20%     |                              |                         |              |
| 60-BPL-060-5-3 |                           |               |                        |                | 33nF ± 20%     |                              |                         |              |

Note: Test voltage: 1500VAC one minute, line to ground  
 Insulation resistance: 300 Mohm min. at 500VDC  
 Voltage drop: 1V max. at rated current  
 Weight: 50g  
 Input: Compatible with IEC-320

# Power Entry Modules Bolt-in with Wire Leads

## 60-BPL Series



# Power Entry Modules Bolt-in with Wire Leads



## 10-BPL Series



### Features

- Ideally suited for products that must conform to FCC part 15 regulations
- Metal case filter offers high performance
- Meets over voltage of IEC 664 category II and complies with IEC 950
- Uses IEC connector that meets most safety standards
- Wire output for minimizing space use and economical installation
- Operating temperature: -25°C to +70°C
- Compact configuration

### Applications

- Digital equipment
- Personal computers and peripherals
- Measuring instruments
- Monitor and display units

### Circuit Diagram



### Specifications

| Model          | Rated Voltage<br>(@ 50/60Hz) | Rated Current | Leakage Current<br>(Max.) | Capacitance    |                | Inductance<br>(L <sub>1</sub> ) | Circuit Diagram | Figure | Temperature Rise<br>(Max.) |
|----------------|------------------------------|---------------|---------------------------|----------------|----------------|---------------------------------|-----------------|--------|----------------------------|
|                |                              |               |                           | C <sub>Y</sub> | C <sub>X</sub> |                                 |                 |        |                            |
| 10-BPL-001-5-B | 250VAC                       | 1A            | 0.50mA                    | 3300pF         | 0.01uF         | 3.0mH                           | 1               | A      | 30°C                       |
| 10-BPL-003-5-B |                              | 3A            |                           |                |                | 1.5mH                           |                 |        |                            |
| 10-BPL-006-5-B |                              | 6A            |                           |                |                | 0.5mH                           |                 |        |                            |

Note: Test voltage: 1500VAC one minute, line to ground  
 Insulation resistance: 300 Mohm min. at 500VDC  
 Voltage drop: 1V max. at rated current  
 Weight: 50g  
 Input: Compatible with IEC-320



# Power Entry Modules Bolt-in with Wire Leads

## 10-BPL Series

**Figure A**



# Power Entry Modules Snap-in Mount

## 60-SPR & SPS Series

### Features

- Ideally suited for products that must conform to FCC part 15 regulations
- Metal cased miniature filter offers high performance
- Meets over voltage of IEC 664 category II and complies with IEC 950
- Uses IEC connector that meets most safety standards
- Snap-in style saves labor and hardware inventory
- Solder lug and fast-on tab terminations available
- Operating temperature: -25°C to +85°C (including temperature rise, see graph on page PF33)
- UL approved low leakage version also available



Tested and found to be IAW VDE 0565 Part 3.



### Applications

- Digital equipment
- Personal computers and peripherals
- Measuring instruments
- Monitor and display units

### Specifications

### Circuit Diagram



| Model*          | Rated Voltage (@ 50/60Hz) | Rated Current | Leakage Current (Max.) | Capacitance    |                | Inductance (L <sub>1</sub> ) | Temperature Rise (Max.) |
|-----------------|---------------------------|---------------|------------------------|----------------|----------------|------------------------------|-------------------------|
|                 |                           |               |                        | C <sub>Y</sub> | C <sub>X</sub> |                              |                         |
| 60-XXX-010-3-2  | 250VAC                    | 1A            | 0.35mA                 | 2200pF ± 20%   | .022uF ± 20%   | 6.0mH                        | 30°C                    |
| 60-XXX-010-3-4  |                           |               |                        |                | .047uF ± 20%   |                              |                         |
| 60-XXX-010-5-2  |                           |               | 0.50mA                 | 3300pF ± 20%   | .022uF ± 20%   |                              |                         |
| 60-XXX-010-5-4  |                           |               |                        |                | .047uF ± 20%   |                              |                         |
| 60-XXX-020-3-2  | 250VAC                    | 2A            | 0.35mA                 | 2200pF ± 20%   | .022uF ± 20%   | 2.4mH                        | 30°C                    |
| 60-XXX-020-3-4  |                           |               |                        |                | .047uF ± 20%   |                              |                         |
| 60-XXX-020-5-2  |                           |               | 0.50mA                 | 3300pF ± 20%   | .022uF ± 20%   |                              |                         |
| 60-XXX-020-5-4  |                           |               |                        |                | .047uF ± 20%   |                              |                         |
| 60-XXX-030-3-2  | 250VAC                    | 3A            | 0.35mA                 | 2200pF ± 20%   | .022uF ± 20%   | 1.2mH                        | 30°C                    |
| 60-XXX-030-3-4  |                           |               |                        |                | .047uF ± 20%   |                              |                         |
| 60-XXX-030-5-2  |                           |               | 0.50mA                 | 3300pF ± 20%   | .022uF ± 20%   |                              |                         |
| 60-XXX-030-5-4  |                           |               |                        |                | .047uF ± 20%   |                              |                         |
| 60-XXX-060-3-2  | 250VAC                    | 6A            | 0.35mA                 | 2200pF ± 20%   | .022uF ± 20%   | 0.53mH                       | 45°C                    |
| 60-XXX-060-3-4  |                           |               |                        |                | .047uF ± 20%   |                              |                         |
| 60-XXX-060-5-2  |                           |               | 0.50mA                 | 3300pF ± 20%   | .022uF ± 20%   |                              |                         |
| 60-XXX-060-5-4  |                           |               |                        |                | .047uF ± 20%   |                              |                         |
| 60-XXX-100-3-2  | 250VAC                    | 10A           | 0.35mA                 | 2200pF ± 20%   | .022uF ± 20%   | 0.26mH                       | 45°C                    |
| 60-XXX-100-5-2  |                           |               | 0.50mA                 | 3300pF ± 20%   |                |                              |                         |
| 60-SPR-150-3-11 | 250VAC                    | 15A           | 0.35mA                 | 2200pF ± 20%   | .1uF ± 20%     | 0.15mH                       | 45°C                    |

Note: Test voltage: 1500VAC one minute, line to ground  
 Insulation resistance: 300 Mohm min. at 500VDC  
 Voltage drop: 1V max. at rated current  
 Weight: 45g  
 Input: Compatible with IEC-320

\* Substitute SPR or SPS for XXX  
 60-SPR - Fast-on terminals  
 60-SPS - Solder lug terminals

# Power Entry Modules Snap-in Mount

## 60-SPR & SPS Series



# Fused Filtered Power Entry Modules

For General Purpose Applications

## 64-65-BFF/64-65-BFS Series



Tested and found to be IAW VDE 0565 Part 3.

### Features

- North American and Metric fuse holders available
- Fuse holder provides effective EMI suppression of common and differential mode
- Suitable for products that must conform to FCC and FTZ requirements
- Meets over voltage category II of IEC 664 and complies with IEC 950
- Fast-on terminals or solder lug terminals
- Metal case provides effective EMI shielding
- Operating temperature: -25°C to +85°C (including temperature rise, see graph on page PF35)

### Applications

- Computers and peripheral equipment
- Electronic equipment
- Digital equipment
- Measuring and testing instruments
- Telecommunications equipment



### Circuit Diagram



### Specifications

| Model*          | Rated Voltage (@ 50/60Hz) | Rated Current | Leakage Current (Max.) | Capacitance    |                | Inductance (L <sub>1</sub> ) | Temperature Rise (Max.) |
|-----------------|---------------------------|---------------|------------------------|----------------|----------------|------------------------------|-------------------------|
|                 |                           |               |                        | C <sub>Y</sub> | C <sub>X</sub> |                              |                         |
| 64-XXX-020-3-11 | 250VAC                    | 2A            | 0.35mA                 | 2200pF ± 20%   | 0.1uF          | 6.5mH                        | 40°C                    |
| 64-XXX-020-5-11 |                           |               | 0.50mA                 | 3300pF ± 20%   |                |                              |                         |
| 64-XXX-020-3-12 |                           |               | 0.35mA                 | 2200pF ± 20%   | 0.22uF         |                              |                         |
| 64-XXX-020-5-12 |                           |               | 0.50mA                 | 3300pF ± 20%   |                |                              |                         |
| 64-XXX-040-3-11 | 250VAC                    | 4A            | 0.35mA                 | 2200pF ± 20%   | 0.1uF          | 4.2mH                        | 45°C                    |
| 64-XXX-040-5-11 |                           |               | 0.50mA                 | 3300pF ± 20%   |                |                              |                         |
| 64-XXX-040-3-12 |                           |               | 0.35mA                 | 2200pF ± 20%   | 0.22uF         |                              |                         |
| 64-XXX-040-5-12 |                           |               | 0.50mA                 | 3300pF ± 20%   |                |                              |                         |
| 64-XXX-060-3-11 | 250VAC                    | 6A            | 0.35mA                 | 2200pF ± 20%   | 0.1uF          | 1.6mH                        | 45°C                    |
| 64-XXX-060-5-11 |                           |               | 0.50mA                 | 3300pF ± 20%   |                |                              |                         |
| 64-XXX-060-3-12 |                           |               | 0.35mA                 | 2200pF ± 20%   | 0.22uF         |                              |                         |
| 64-XXX-060-5-12 |                           |               | 0.50mA                 | 3300pF ± 20%   |                |                              |                         |
| 65-XXX-020-3-11 | 125VAC                    | 2A            | 0.20mA                 | 2200pF ± 20%   | 0.1uF          | 6.5mH                        | 40°C                    |
| 65-XXX-020-5-11 |                           |               | 0.25mA                 | 3300pF ± 20%   |                |                              |                         |
| 65-XXX-020-3-12 |                           |               | 0.20mA                 | 2200pF ± 20%   | 0.22uF         |                              |                         |
| 65-XXX-020-5-12 |                           |               | 0.25mA                 | 3300pF ± 20%   |                |                              |                         |
| 65-XXX-040-3-11 | 125VAC                    | 4A            | 0.20mA                 | 2200pF ± 20%   | 0.1uF          | 4.2mH                        | 45°C                    |
| 65-XXX-040-5-11 |                           |               | 0.25mA                 | 3300pF ± 20%   |                |                              |                         |
| 65-XXX-040-3-12 |                           |               | 0.20mA                 | 2200pF ± 20%   | 0.22uF         |                              |                         |
| 65-XXX-040-5-12 |                           |               | 0.25mA                 | 3300pF ± 20%   |                |                              |                         |
| 65-XXX-060-3-11 | 125VAC                    | 6A            | 0.20mA                 | 2200pF ± 20%   | 0.1uF          | 1.6mH                        | 45°C                    |
| 65-XXX-060-5-11 |                           |               | 0.25mA                 | 3300pF ± 20%   |                |                              |                         |
| 65-XXX-060-3-12 |                           |               | 0.20mA                 | 2200pF ± 20%   | 0.22uF         |                              |                         |
| 65-XXX-060-5-12 |                           |               | 0.25mA                 | 3300pF ± 20%   |                |                              |                         |

Note: Test Voltage 1500VAC one minute, line to ground  
Insulation Resistance: 300 MΩ min. at 500VDC  
F(S) = Fast-on or (Solder lug terminals)

Voltage Drop: 1V max. at rated current  
Weight: 78g  
Inlet: Compatible with IEC-320

\* Substitute BFF or BFS for XXX  
BFF - Fast-on terminals  
BFS - Solder lug terminals

# Fused Filtered Power Entry Modules

For General Purpose Applications

## 64-65-BFF/64-65-BFS Series

### Temperature Characteristics



### Dimensions 64/65-BFF Series



Dimensions in inches (mm)

### Common Mode



#### 0.50 mA Leakage Versions



#### 0.35 mA Leakage Versions



### Normal Mode



#### 0.50 mA Leakage Versions



#### 0.35 mA Leakage Versions



# Fused Filtered Power Entry Modules

For Medical or General Purpose Applications

## 66-67-BFF/66-67-BFS Series



Tested and found to be IAW VDE 0565 Part 3.

### Features

- Metric and North American fuse holders available
- Fuse holder provides effective EMI suppression of common and differential mode
- Suitable for products that must conform to FCC and FTZ requirements
- Meets over voltage category II of IEC 664 and complies with IEC 950
- Fast-on terminations or solder lug terminations
- Metal case provides effective EMI shielding
- Provides susceptibility protection without the leakage current associated with line-to-ground capacitance
- Reduces the line to ground capacitance in order to meet patient care requirements
- Operating temperature: -25°C to +85°C (including temperature rise, see graph on page PF37)



### Applications

- Medical equipment
- Electronic equipment
- Digital equipment
- Industrial equipment
- Telecommunications equipment
- Measuring and testing instruments
- Personal computers and peripherals

### Circuit Diagrams

66/67-BFF(S)-XXX-1-X Filter



66/67-BFF(S)-XXX-0-X and 66/67-BFF(S)-XXX-4-X Filters



### Specifications

| Model*          | Rated Voltage (@ 50/60Hz) | Rated Current | Leakage Current (Max.) | Capacitance    |                | Inductance (L <sub>1</sub> ) | Temperature Rise (Max.) |         |
|-----------------|---------------------------|---------------|------------------------|----------------|----------------|------------------------------|-------------------------|---------|
|                 |                           |               |                        | C <sub>V</sub> | C <sub>X</sub> |                              |                         |         |
| 66-XXX-020-1-11 | 250VAC                    | 2A            | 0.01mA                 | none           | 330pF ± 20%    | 6.5mH                        | 40°C                    |         |
| 66-XXX-020-1-12 |                           |               |                        |                |                |                              |                         | 0.1uF   |
| 66-XXX-020-0-11 |                           |               |                        |                |                |                              |                         | 0.22uF  |
| 66-XXX-020-4-11 |                           |               |                        |                |                |                              |                         | 0.075mA |
| 66-XXX-020-0-12 |                           |               |                        |                |                |                              |                         | 0.1mA   |
| 66-XXX-020-4-12 |                           |               |                        |                |                |                              |                         | 0.075mA |
| 66-XXX-040-1-11 | 250VAC                    | 4A            | 0.01mA                 | none           | 330pF ± 20%    | 2.4mH                        | 45°C                    |         |
| 66-XXX-040-1-12 |                           |               |                        |                |                |                              |                         | 0.1uF   |
| 66-XXX-040-0-11 |                           |               |                        |                |                |                              |                         | 0.22uF  |
| 66-XXX-040-4-11 |                           |               |                        |                |                |                              |                         | 0.075mA |
| 66-XXX-040-0-12 |                           |               |                        |                |                |                              |                         | 0.1mA   |
| 66-XXX-040-4-12 |                           |               |                        |                |                |                              |                         | 0.075mA |
| 66-XXX-060-1-11 | 250VAC                    | 6A            | 0.01mA                 | none           | 330pF ± 20%    | 1.6mH                        | 45°C                    |         |
| 66-XXX-060-1-12 |                           |               |                        |                |                |                              |                         | 0.1uF   |
| 66-XXX-060-0-11 |                           |               |                        |                |                |                              |                         | 0.22uF  |
| 66-XXX-060-4-11 |                           |               |                        |                |                |                              |                         | 0.075mA |
| 66-XXX-060-0-12 |                           |               |                        |                |                |                              |                         | 0.1mA   |
| 66-XXX-060-4-12 |                           |               |                        |                |                |                              |                         | 0.075mA |
| 67-XXX-020-1-11 | 125VAC                    | 2A            | 0.005mA                | none           | 330pF ± 20%    | 6.5mH                        | 40°C                    |         |
| 67-XXX-020-1-12 |                           |               |                        |                |                |                              |                         | 0.1uF   |
| 67-XXX-020-0-11 |                           |               |                        |                |                |                              |                         | 0.22uF  |
| 67-XXX-020-4-11 |                           |               |                        |                |                |                              |                         | 0.035mA |
| 67-XXX-020-0-12 |                           |               |                        |                |                |                              |                         | 0.05mA  |
| 67-XXX-020-4-12 |                           |               |                        |                |                |                              |                         | 0.035mA |
| 67-XXX-040-1-11 | 125VAC                    | 4A            | 0.005mA                | none           | 330pF ± 20%    | 2.4mH                        | 45°C                    |         |
| 67-XXX-040-1-12 |                           |               |                        |                |                |                              |                         | 0.1uF   |
| 67-XXX-040-0-11 |                           |               |                        |                |                |                              |                         | 0.22uF  |
| 67-XXX-040-4-11 |                           |               |                        |                |                |                              |                         | 0.035mA |
| 67-XXX-040-0-12 |                           |               |                        |                |                |                              |                         | 0.05mA  |
| 67-XXX-040-4-12 |                           |               |                        |                |                |                              |                         | 0.035mA |
| 67-XXX-060-1-11 | 125VAC                    | 6A            | 0.005mA                | none           | 330pF ± 20%    | 1.6mH                        | 45°C                    |         |
| 67-XXX-060-1-12 |                           |               |                        |                |                |                              |                         | 0.1uF   |
| 67-XXX-060-0-11 |                           |               |                        |                |                |                              |                         | 0.22uF  |
| 67-XXX-060-4-11 |                           |               |                        |                |                |                              |                         | 0.035mA |
| 67-XXX-060-0-12 |                           |               |                        |                |                |                              |                         | 0.05mA  |
| 67-XXX-060-4-12 |                           |               |                        |                |                |                              |                         | 0.035mA |

Note: Test Voltage 1500VAC one minute, line to ground  
Insulation Resistance: 300 MΩ min. at 500VDC  
F(S) = Fast-on or (Solder lug terminals)

Voltage Drop: 1V max. at rated current  
Weight: 78g  
Inlet: Compatible with IEC-320

\* Substitute BFF or BFS for XXX  
BFF - Fast-on terminals  
BFS - Solder lug terminals

# Fused Filtered Power Entry Modules

For Medical or General Purpose Applications

## 66-67-BFF/66-67-BFS Series



### Dimensions

#### 66-67-BFF/66-67-BFS Series



# Switched and Fused Filtered Power Entry Modules

For General Purpose Applications



## 64-65-BSF/64-65-SSF Series

### Features

- North American and Metric fuse holders available
- Fuse holder and double pole power ON/OFF switch provided in a convenient/compact package
- Suitable for products that must conform to FCC and FTZ requirements
- Meets over voltage category II of IEC 664 and complies with IEC 950
- Metal case provides effective EMI shielding
- Easy access fuse drawer with space for spare fuse
- Flange-mounted or snap-in styles available for quick mounting
- Operating temperature: -25°C to +85°C (including temperature rise, see graph on page PF39)



Tested and found to be IAW VDE 0565 Part 3.

### Applications

- Computers and peripheral equipment
- Digital equipment
- Electronic equipment
- Measuring and testing instruments
- Telecommunications equipment

### Circuit Diagram



### Specifications

| Model*          | Rated Voltage (@ 50/60Hz) | Rated Current | Leakage Current (Max.) | Capacitance    |                 |                 | Inductance (L <sub>1</sub> ) | Temperature Rise (Max.) |
|-----------------|---------------------------|---------------|------------------------|----------------|-----------------|-----------------|------------------------------|-------------------------|
|                 |                           |               |                        | C <sub>Y</sub> | C <sub>X1</sub> | C <sub>X2</sub> |                              |                         |
| 64-XXX-020-3-12 | 250VAC                    | 2A            | 0.35mA                 | 2200pF         | 0.22uF          | NONE            | 10.5mH                       | 45°C                    |
| 64-XXX-020-3-04 |                           |               |                        |                |                 | 0.22uF          |                              |                         |
| 64-XXX-020-3-14 |                           |               |                        |                |                 | NONE            |                              |                         |
| 64-XXX-020-3-06 |                           |               | 0.22uF                 |                |                 |                 |                              |                         |
| 64-XXX-020-5-12 |                           |               | 0.50mA                 | 3300pF         | 0.22uF          | NONE            |                              |                         |
| 64-XXX-020-5-04 |                           |               |                        |                |                 | 0.22uF          |                              |                         |
| 64-XXX-020-5-14 | NONE                      |               |                        |                |                 |                 |                              |                         |
| 64-XXX-020-5-06 | 250VAC                    | 4A            | 0.35mA                 | 2200pF         | 0.22uF          | NONE            | 4.2mH                        | 45°C                    |
| 64-XXX-040-3-04 |                           |               |                        |                |                 | 0.22uF          |                              |                         |
| 64-XXX-040-3-14 |                           |               |                        |                |                 | NONE            |                              |                         |
| 64-XXX-040-3-06 |                           |               | 0.22uF                 |                |                 |                 |                              |                         |
| 64-XXX-040-5-12 |                           |               | 0.50mA                 | 3300pF         | 0.22uF          | NONE            |                              |                         |
| 64-XXX-040-5-04 |                           |               |                        |                |                 | 0.22uF          |                              |                         |
| 64-XXX-040-5-14 | NONE                      |               |                        |                |                 |                 |                              |                         |
| 64-XXX-040-5-06 | 250VAC                    | 6A            | 0.35mA                 | 2200pF         | 0.22uF          | NONE            | 1.6mH                        | 45°C                    |
| 64-XXX-060-3-04 |                           |               |                        |                |                 | 0.22uF          |                              |                         |
| 64-XXX-060-3-14 |                           |               |                        |                |                 | NONE            |                              |                         |
| 64-XXX-060-3-06 |                           |               | 0.22uF                 |                |                 |                 |                              |                         |
| 64-XXX-060-5-12 |                           |               | 0.50mA                 | 3300pF         | 0.22uF          | NONE            |                              |                         |
| 64-XXX-060-5-04 |                           |               |                        |                |                 | 0.22uF          |                              |                         |
| 64-XXX-060-5-14 | NONE                      |               |                        |                |                 |                 |                              |                         |
| 64-XXX-060-5-06 | 125VAC                    | 2A            | 0.20mA                 | 2200pF         | 0.22uF          | NONE            | 10.5mH                       | 45°C                    |
| 65-XXX-020-3-04 |                           |               |                        |                |                 | 0.22uF          |                              |                         |
| 65-XXX-020-3-14 |                           |               |                        |                |                 | NONE            |                              |                         |
| 65-XXX-020-3-06 |                           |               | 0.22uF                 |                |                 |                 |                              |                         |
| 65-XXX-020-5-12 |                           |               | 0.25mA                 | 3300pF         | 0.22uF          | NONE            |                              |                         |
| 65-XXX-020-5-04 |                           |               |                        |                |                 | 0.22uF          |                              |                         |
| 65-XXX-020-5-14 | NONE                      |               |                        |                |                 |                 |                              |                         |
| 65-XXX-020-5-06 | 125VAC                    | 4A            | 0.20mA                 | 2200pF         | 0.22uF          | NONE            | 4.2mH                        | 45°C                    |
| 65-XXX-040-3-04 |                           |               |                        |                |                 | 0.22uF          |                              |                         |
| 65-XXX-040-3-14 |                           |               |                        |                |                 | NONE            |                              |                         |
| 65-XXX-040-3-06 |                           |               | 0.22uF                 |                |                 |                 |                              |                         |
| 65-XXX-040-5-12 |                           |               | 0.25mA                 | 3300pF         | 0.22uF          | NONE            |                              |                         |
| 65-XXX-040-5-04 |                           |               |                        |                |                 | 0.22uF          |                              |                         |
| 65-XXX-040-5-14 | NONE                      |               |                        |                |                 |                 |                              |                         |
| 65-XXX-040-5-06 | 125VAC                    | 6A            | 0.20mA                 | 2200pF         | 0.22uF          | NONE            | 1.6mH                        | 45°C                    |
| 65-XXX-060-3-04 |                           |               |                        |                |                 | 0.22uF          |                              |                         |
| 65-XXX-060-3-14 |                           |               |                        |                |                 | NONE            |                              |                         |
| 65-XXX-060-3-06 |                           |               | 0.22uF                 |                |                 |                 |                              |                         |
| 65-XXX-060-5-12 |                           |               | 0.25mA                 | 3300pF         | 0.22uF          | NONE            |                              |                         |
| 65-XXX-060-5-04 |                           |               |                        |                |                 | 0.22uF          |                              |                         |
| 65-XXX-060-5-14 | NONE                      |               |                        |                |                 |                 |                              |                         |
| 65-XXX-060-5-06 | 125VAC                    | 2A            | 0.20mA                 | 2200pF         | 0.22uF          | NONE            | 10.5mH                       | 45°C                    |
| 65-XXX-020-3-04 |                           |               |                        |                |                 | 0.22uF          |                              |                         |
| 65-XXX-020-3-14 |                           |               |                        |                |                 | NONE            |                              |                         |
| 65-XXX-020-3-06 |                           |               | 0.22uF                 |                |                 |                 |                              |                         |
| 65-XXX-020-5-12 |                           |               | 0.25mA                 | 3300pF         | 0.22uF          | NONE            |                              |                         |
| 65-XXX-020-5-04 |                           |               |                        |                |                 | 0.22uF          |                              |                         |
| 65-XXX-020-5-14 | NONE                      |               |                        |                |                 |                 |                              |                         |
| 65-XXX-020-5-06 | 125VAC                    | 4A            | 0.20mA                 | 2200pF         | 0.22uF          | NONE            | 4.2mH                        | 45°C                    |
| 65-XXX-040-3-04 |                           |               |                        |                |                 | 0.22uF          |                              |                         |
| 65-XXX-040-3-14 |                           |               |                        |                |                 | NONE            |                              |                         |
| 65-XXX-040-3-06 |                           |               | 0.22uF                 |                |                 |                 |                              |                         |
| 65-XXX-040-5-12 |                           |               | 0.25mA                 | 3300pF         | 0.22uF          | NONE            |                              |                         |
| 65-XXX-040-5-04 |                           |               |                        |                |                 | 0.22uF          |                              |                         |
| 65-XXX-040-5-14 | NONE                      |               |                        |                |                 |                 |                              |                         |
| 65-XXX-040-5-06 | 125VAC                    | 6A            | 0.20mA                 | 2200pF         | 0.22uF          | NONE            | 1.6mH                        | 45°C                    |
| 65-XXX-060-3-04 |                           |               |                        |                |                 | 0.22uF          |                              |                         |
| 65-XXX-060-3-14 |                           |               |                        |                |                 | NONE            |                              |                         |
| 65-XXX-060-3-06 |                           |               | 0.22uF                 |                |                 |                 |                              |                         |
| 65-XXX-060-5-12 |                           |               | 0.25mA                 | 3300pF         | 0.22uF          | NONE            |                              |                         |
| 65-XXX-060-5-04 |                           |               |                        |                |                 | 0.22uF          |                              |                         |
| 65-XXX-060-5-14 | NONE                      |               |                        |                |                 |                 |                              |                         |
| 65-XXX-060-5-06 | 125VAC                    | 2A            | 0.20mA                 | 2200pF         | 0.22uF          | NONE            | 10.5mH                       | 45°C                    |
| 65-XXX-020-3-04 |                           |               |                        |                |                 | 0.22uF          |                              |                         |
| 65-XXX-020-3-14 |                           |               |                        |                |                 | NONE            |                              |                         |
| 65-XXX-020-3-06 |                           |               | 0.22uF                 |                |                 |                 |                              |                         |
| 65-XXX-020-5-12 |                           |               | 0.25mA                 | 3300pF         | 0.22uF          | NONE            |                              |                         |
| 65-XXX-020-5-04 |                           |               |                        |                |                 | 0.22uF          |                              |                         |
| 65-XXX-020-5-14 | NONE                      |               |                        |                |                 |                 |                              |                         |
| 65-XXX-020-5-06 | 125VAC                    | 4A            | 0.20mA                 | 2200pF         | 0.22uF          | NONE            | 4.2mH                        | 45°C                    |
| 65-XXX-040-3-04 |                           |               |                        |                |                 | 0.22uF          |                              |                         |
| 65-XXX-040-3-14 |                           |               |                        |                |                 | NONE            |                              |                         |
| 65-XXX-040-3-06 |                           |               | 0.22uF                 |                |                 |                 |                              |                         |
| 65-XXX-040-5-12 |                           |               | 0.25mA                 | 3300pF         | 0.22uF          | NONE            |                              |                         |
| 65-XXX-040-5-04 |                           |               |                        |                |                 | 0.22uF          |                              |                         |
| 65-XXX-040-5-14 | NONE                      |               |                        |                |                 |                 |                              |                         |
| 65-XXX-040-5-06 | 125VAC                    | 6A            | 0.20mA                 | 2200pF         | 0.22uF          | NONE            | 1.6mH                        | 45°C                    |
| 65-XXX-060-3-04 |                           |               |                        |                |                 | 0.22uF          |                              |                         |
| 65-XXX-060-3-14 |                           |               |                        |                |                 | NONE            |                              |                         |
| 65-XXX-060-3-06 |                           |               | 0.22uF                 |                |                 |                 |                              |                         |
| 65-XXX-060-5-12 |                           |               | 0.25mA                 | 3300pF         | 0.22uF          | NONE            |                              |                         |
| 65-XXX-060-5-04 |                           |               |                        |                |                 | 0.22uF          |                              |                         |
| 65-XXX-060-5-14 | NONE                      |               |                        |                |                 |                 |                              |                         |
| 65-XXX-060-5-06 | 125VAC                    | 2A            | 0.20mA                 | 2200pF         | 0.22uF          | NONE            | 10.5mH                       | 45°C                    |
| 65-XXX-020-3-04 |                           |               |                        |                |                 | 0.22uF          |                              |                         |
| 65-XXX-020-3-14 |                           |               |                        |                |                 | NONE            |                              |                         |
| 65-XXX-020-3-06 |                           |               | 0.22uF                 |                |                 |                 |                              |                         |
| 65-XXX-020-5-12 |                           |               | 0.25mA                 | 3300pF         | 0.22uF          | NONE            |                              |                         |
| 65-XXX-020-5-04 |                           |               |                        |                |                 | 0.22uF          |                              |                         |
| 65-XXX-020-5-14 | NONE                      |               |                        |                |                 |                 |                              |                         |
| 65-XXX-020-5-06 | 125VAC                    | 4A            | 0.20mA                 | 2200pF         | 0.22uF          | NONE            | 4.2mH                        | 45°C                    |
| 65-XXX-040-3-04 |                           |               |                        |                |                 | 0.22uF          |                              |                         |
| 65-XXX-040-3-14 |                           |               |                        |                |                 | NONE            |                              |                         |
| 65-XXX-040-3-06 |                           |               | 0.22uF                 |                |                 |                 |                              |                         |
| 65-XXX-040-5-12 |                           |               | 0.25mA                 | 3300pF         | 0.22uF          | NONE            |                              |                         |
| 65-XXX-040-5-04 |                           |               |                        |                |                 | 0.22uF          |                              |                         |
| 65-XXX-040-5-14 | NONE                      |               |                        |                |                 |                 |                              |                         |
| 65-XXX-040-5-06 | 125VAC                    | 6A            | 0.20mA                 | 2200pF         | 0.22uF          | NONE            | 1.6mH                        | 45°C                    |
| 65-XXX-060-3-04 |                           |               |                        |                |                 | 0.22uF          |                              |                         |
| 65-XXX-060-3-14 |                           |               |                        |                |                 | NONE            |                              |                         |
| 65-XXX-060-3-06 |                           |               | 0.22uF                 |                |                 |                 |                              |                         |
| 65-XXX-060-5-12 |                           |               | 0.25mA                 | 3300pF         | 0.22uF          | NONE            |                              |                         |
| 65-XXX-060-5-04 |                           |               |                        |                |                 | 0.22uF          |                              |                         |
| 65-XXX-060-5-14 | NONE                      |               |                        |                |                 |                 |                              |                         |
| 65-XXX-060-5-06 | 125VAC                    | 2A            | 0.20mA                 | 2200pF         | 0.22uF          | NONE            | 10.5mH                       | 45°C                    |
| 65-XXX-020-3-04 |                           |               |                        |                |                 | 0.22uF          |                              |                         |
| 65-XXX-020-3-14 |                           |               |                        |                |                 | NONE            |                              |                         |
| 65-XXX-020-3-06 |                           |               | 0.22uF                 |                |                 |                 |                              |                         |
| 65-XXX-020-5-12 |                           |               | 0.25mA                 | 3300pF         | 0.22uF          | NONE            |                              |                         |
| 65-XXX-020-5-04 |                           |               |                        |                |                 | 0.22uF          |                              |                         |
| 65-XXX-020-5-14 | NONE                      |               |                        |                |                 |                 |                              |                         |
| 65-XXX-020-5-06 | 125VAC                    | 4A            | 0.20mA                 | 2200pF         | 0.22uF          | NONE            | 4.2mH                        | 45°C                    |
| 65-XXX-040-3-04 |                           |               |                        |                |                 | 0.22uF          |                              |                         |
| 65-XXX-040-3-14 |                           |               |                        |                |                 | NONE            |                              |                         |
| 65-XXX-040-3-06 |                           |               | 0.22uF                 |                |                 |                 |                              |                         |
| 65-XXX-040-5-12 |                           |               | 0.25mA                 | 3300pF         | 0.22uF          | NONE            |                              |                         |
| 65-XXX-040-5-04 |                           |               |                        |                |                 | 0.22uF          |                              |                         |
| 65-XXX-040-5-14 | NONE                      |               |                        |                |                 |                 |                              |                         |
| 65-XXX-040-5-06 | 125VAC                    | 6A            | 0.20mA                 | 2200pF         | 0.22uF          | NONE            | 1.6mH                        | 45°C                    |
| 65-XXX-060-3-04 |                           |               |                        |                |                 | 0.22uF          |                              |                         |
| 65-XXX-060-3-14 |                           |               |                        |                |                 | NONE            |                              |                         |
| 65-XXX-060-3-06 |                           |               | 0.22uF                 |                |                 |                 |                              |                         |
| 65-XXX-060-5-12 |                           |               | 0.25mA                 | 3300pF         | 0.22uF          | NONE            |                              |                         |
| 65-XXX-060-5-04 |                           |               |                        |                |                 | 0.22uF          |                              |                         |
| 65-XXX-060-5-14 | NONE                      |               |                        |                |                 |                 |                              |                         |

Note: Test Voltage 1500VAC one minute, line to ground  
Insulation Resistance: 300 MΩ min. at 500VDC  
B(S) = Bolt-in terminals or (Snap-in terminals)

Voltage Drop: 1V max. at rated current  
Weight: 130g  
Inlet: Compatible with IEC-320

\* Substitute BSF or SSF for XXX  
BSF - Bolt-in switched and fused  
SSF - Snap-in switched and fused



# Switched and Fused Filtered Power Entry Modules

For General Purpose Applications

## Temperature Characteristics



## Dimensions

### 64/65-BSF Series



### 64/65-SSF Series



## Common Mode



### 0.35 mA Leakage Versions



### 0.50 mA Leakage Versions



## Normal Mode



### 64/65-B(S)SF-\*-02(04,06)



### 64/65-B(S)SF-\*-11(12,14)



# Switched and Fused Filtered Power Entry Modules

For Medical or General Purpose Applications

## 66-67-BSF/66-67-SSF Series



Tested and found to be IAW VDE 0565 Part 3

### Features

- Metric and North American fuse holders available
- Fuse holder and a double pole power ON/OFF switch provides a convenient/compact package
- Suitable for products that must conform to FCC and FTZ requirements
- Meets over voltage category II of IEC 664 and complies with IEC 950
- Provides susceptibility protection without the leakage current associated with line-to-ground capacitors
- Designed to meet requirements for non-patient and patient care equipment
- Metal case provides effective EMI shielding
- Easy access fuse drawer - space for spare fuse
- Flange-mounted or snap-in styles available for quick mounting
- Operating temperature: -25°C to +85°C (including temperature rise, see graph on page PF41)

### Specifications

| Model*          | Rated Voltage 50/60Hz | Rated Current | Leakage Current (Max.) | Capacitance    |                 |                 | Temp. Induct. (L <sub>1</sub> ) | Rise (Max.) |       |       |       |      |
|-----------------|-----------------------|---------------|------------------------|----------------|-----------------|-----------------|---------------------------------|-------------|-------|-------|-------|------|
|                 |                       |               |                        | C <sub>Y</sub> | C <sub>X1</sub> | C <sub>X2</sub> |                                 |             |       |       |       |      |
| 66-XXX-020-0-12 | 250 VAC               | 2A            | .075mA                 | 330pF          | 0.22uF          | NONE            | 10.5mH                          | 40°C        |       |       |       |      |
| 66-XXX-020-0-04 |                       |               |                        |                | 0.22uF          | NONE            |                                 |             |       |       |       |      |
| 66-XXX-020-0-14 |                       |               |                        |                | 0.47uF          | NONE            |                                 |             |       |       |       |      |
| 66-XXX-020-0-06 |                       |               |                        |                | 0.22uF          | NONE            |                                 |             |       |       |       |      |
| 66-XXX-020-1-12 |                       |               |                        |                | 0.22uF          | NONE            |                                 |             |       |       |       |      |
| 66-XXX-020-1-04 |                       |               |                        |                | 0.22uF          | NONE            |                                 |             |       |       |       |      |
| 66-XXX-020-1-14 |                       |               | 0.47uF                 | NONE           |                 |                 |                                 |             |       |       |       |      |
| 66-XXX-020-1-06 |                       |               | 0.22uF                 | NONE           |                 |                 |                                 |             |       |       |       |      |
| 66-XXX-020-4-12 |                       |               | 0.1mA                  | 470pF          | 0.22uF          | NONE            |                                 |             | 4.2mH | 45°C  |       |      |
| 66-XXX-020-4-04 |                       |               |                        |                | 0.22uF          | NONE            |                                 |             |       |       |       |      |
| 66-XXX-020-4-14 |                       |               |                        |                | 0.47uF          | NONE            |                                 |             |       |       |       |      |
| 66-XXX-020-4-06 |                       |               |                        |                | 0.22uF          | NONE            |                                 |             |       |       |       |      |
| 66-XXX-040-0-12 |                       | 4A            |                        |                | .075mA          | 330pF           | 0.22uF                          | NONE        |       |       | 1.6mH | 45°C |
| 66-XXX-040-0-04 |                       |               |                        |                |                 |                 | 0.22uF                          | NONE        |       |       |       |      |
| 66-XXX-040-0-14 |                       |               | 0.47uF                 | NONE           |                 |                 |                                 |             |       |       |       |      |
| 66-XXX-040-0-06 |                       |               | 0.22uF                 | NONE           |                 |                 |                                 |             |       |       |       |      |
| 66-XXX-040-1-12 |                       |               | 0.22uF                 | NONE           |                 |                 |                                 |             |       |       |       |      |
| 66-XXX-040-1-04 |                       |               | 0.22uF                 | NONE           |                 |                 |                                 |             |       |       |       |      |
| 66-XXX-040-1-14 |                       |               | 0.47uF                 | NONE           |                 |                 |                                 |             |       |       |       |      |
| 66-XXX-040-1-06 |                       |               | 0.22uF                 | NONE           |                 |                 |                                 |             |       |       |       |      |
| 66-XXX-040-4-12 |                       |               | .01mA                  | 470pF          | 0.22uF          | NONE            | 1.6mH                           | 45°C        |       |       |       |      |
| 66-XXX-040-4-04 |                       |               |                        |                | 0.22uF          | NONE            |                                 |             |       |       |       |      |
| 66-XXX-040-4-14 |                       |               |                        |                | 0.47uF          | NONE            |                                 |             |       |       |       |      |
| 66-XXX-040-4-06 |                       |               |                        |                | 0.22uF          | NONE            |                                 |             |       |       |       |      |
| 66-XXX-060-0-12 | 6A                    | .075mA        |                        |                | 330pF           | 0.22uF          |                                 |             | NONE  | 1.6mH | 45°C  |      |
| 66-XXX-060-0-04 |                       |               |                        |                |                 | 0.22uF          |                                 |             | NONE  |       |       |      |
| 66-XXX-060-0-14 |                       |               | 0.47uF                 | NONE           |                 |                 |                                 |             |       |       |       |      |
| 66-XXX-060-0-06 |                       |               | 0.22uF                 | NONE           |                 |                 |                                 |             |       |       |       |      |
| 66-XXX-060-1-12 |                       |               | 0.22uF                 | NONE           |                 |                 |                                 |             |       |       |       |      |
| 66-XXX-060-1-04 |                       |               | 0.22uF                 | NONE           |                 |                 |                                 |             |       |       |       |      |
| 66-XXX-060-1-14 |                       | 0.47uF        | NONE                   |                |                 |                 |                                 |             |       |       |       |      |
| 66-XXX-060-1-06 |                       | 0.22uF        | NONE                   |                |                 |                 |                                 |             |       |       |       |      |
| 66-XXX-060-4-12 |                       | 0.1mA         | 470pF                  | 0.22uF         | NONE            | 1.6mH           | 45°C                            |             |       |       |       |      |
| 66-XXX-060-4-04 |                       |               |                        | 0.22uF         | NONE            |                 |                                 |             |       |       |       |      |
| 66-XXX-060-4-14 |                       |               |                        | 0.47uF         | NONE            |                 |                                 |             |       |       |       |      |
| 66-XXX-060-4-06 |                       |               |                        | 0.22uF         | NONE            |                 |                                 |             |       |       |       |      |



### Applications

- Medical equipment
- Industrial equipment
- Telecommunications equipment
- Measuring and testing instruments
- Digital equipment (including switching power supplies)
- General purpose filter for susceptibility or high frequency "clean up" applications

### Circuit Diagram

Note: C<sub>Y1</sub> and C<sub>Y2</sub> capacitors omitted on 66/67 B(S)F-XXX-1-X Filters



| Model*          | Rated Voltage 50/60Hz | Rated Current | Leakage Current (Max.) | Capacitance    |                 |                 | Temp. Induct. (L <sub>1</sub> ) | Rise (Max.) |       |       |       |      |
|-----------------|-----------------------|---------------|------------------------|----------------|-----------------|-----------------|---------------------------------|-------------|-------|-------|-------|------|
|                 |                       |               |                        | C <sub>Y</sub> | C <sub>X1</sub> | C <sub>X2</sub> |                                 |             |       |       |       |      |
| 67-XXX-020-0-12 | 125 VAC               | 2A            | 0.04mA                 | 330pF          | 0.22uF          | NONE            | 10.5mH                          | 40°C        |       |       |       |      |
| 67-XXX-020-0-04 |                       |               |                        |                | 0.22uF          | NONE            |                                 |             |       |       |       |      |
| 67-XXX-020-0-14 |                       |               |                        |                | 0.47uF          | NONE            |                                 |             |       |       |       |      |
| 67-XXX-020-0-06 |                       |               |                        |                | 0.22uF          | NONE            |                                 |             |       |       |       |      |
| 67-XXX-020-1-12 |                       |               |                        |                | 0.22uF          | NONE            |                                 |             |       |       |       |      |
| 67-XXX-020-1-04 |                       |               |                        |                | 0.22uF          | NONE            |                                 |             |       |       |       |      |
| 67-XXX-020-1-14 |                       |               | 0.47uF                 | NONE           |                 |                 |                                 |             |       |       |       |      |
| 67-XXX-020-1-06 |                       |               | 0.22uF                 | NONE           |                 |                 |                                 |             |       |       |       |      |
| 67-XXX-020-4-12 |                       |               | 0.05mA                 | 470pF          | 0.22uF          | NONE            |                                 |             | 4.2mH | 45°C  |       |      |
| 67-XXX-020-4-04 |                       |               |                        |                | 0.22uF          | NONE            |                                 |             |       |       |       |      |
| 67-XXX-020-4-14 |                       |               |                        |                | 0.47uF          | NONE            |                                 |             |       |       |       |      |
| 67-XXX-020-4-06 |                       |               |                        |                | 0.22uF          | NONE            |                                 |             |       |       |       |      |
| 67-XXX-040-0-12 |                       | 4A            |                        |                | 0.04mA          | 330pF           | 0.22uF                          | NONE        |       |       | 1.6mH | 45°C |
| 67-XXX-040-0-04 |                       |               |                        |                |                 |                 | 0.22uF                          | NONE        |       |       |       |      |
| 67-XXX-040-0-14 |                       |               | 0.47uF                 | NONE           |                 |                 |                                 |             |       |       |       |      |
| 67-XXX-040-0-06 |                       |               | 0.22uF                 | NONE           |                 |                 |                                 |             |       |       |       |      |
| 67-XXX-040-1-12 |                       |               | 0.22uF                 | NONE           |                 |                 |                                 |             |       |       |       |      |
| 67-XXX-040-1-04 |                       |               | 0.22uF                 | NONE           |                 |                 |                                 |             |       |       |       |      |
| 67-XXX-040-1-14 |                       |               | 0.47uF                 | NONE           |                 |                 |                                 |             |       |       |       |      |
| 67-XXX-040-1-06 |                       |               | 0.22uF                 | NONE           |                 |                 |                                 |             |       |       |       |      |
| 67-XXX-040-4-12 |                       |               | 0.05mA                 | 470pF          | 0.22uF          | NONE            | 1.6mH                           | 45°C        |       |       |       |      |
| 67-XXX-040-4-04 |                       |               |                        |                | 0.22uF          | NONE            |                                 |             |       |       |       |      |
| 67-XXX-040-4-14 |                       |               |                        |                | 0.47uF          | NONE            |                                 |             |       |       |       |      |
| 67-XXX-040-4-06 |                       |               |                        |                | 0.22uF          | NONE            |                                 |             |       |       |       |      |
| 67-XXX-060-0-12 | 6A                    | 0.04mA        |                        |                | 330pF           | 0.22uF          |                                 |             | NONE  | 1.6mH | 45°C  |      |
| 67-XXX-060-0-04 |                       |               |                        |                |                 | 0.22uF          |                                 |             | NONE  |       |       |      |
| 67-XXX-060-0-14 |                       |               | 0.47uF                 | NONE           |                 |                 |                                 |             |       |       |       |      |
| 67-XXX-060-0-06 |                       |               | 0.22uF                 | NONE           |                 |                 |                                 |             |       |       |       |      |
| 67-XXX-060-1-12 |                       |               | 0.22uF                 | NONE           |                 |                 |                                 |             |       |       |       |      |
| 67-XXX-060-1-04 |                       |               | 0.22uF                 | NONE           |                 |                 |                                 |             |       |       |       |      |
| 67-XXX-060-1-14 |                       | 0.47uF        | NONE                   |                |                 |                 |                                 |             |       |       |       |      |
| 67-XXX-060-1-06 |                       | 0.22uF        | NONE                   |                |                 |                 |                                 |             |       |       |       |      |
| 67-XXX-060-4-12 |                       | 0.05mA        | 470pF                  | 0.22uF         | NONE            | 1.6mH           | 45°C                            |             |       |       |       |      |
| 67-XXX-060-4-04 |                       |               |                        | 0.22uF         | NONE            |                 |                                 |             |       |       |       |      |
| 67-XXX-060-4-14 |                       |               |                        | 0.47uF         | NONE            |                 |                                 |             |       |       |       |      |
| 67-XXX-060-4-06 |                       |               |                        | 0.22uF         | NONE            |                 |                                 |             |       |       |       |      |

Note: Test Voltage: 1500VAC one minute, line to ground  
Insulation Resistance: 300 MΩ min. at 500VDC  
Voltage Drop: 1V max. at rated current

Weight: 130g  
Inlet: Compatible with IEC-320  
B(S) = Bolt-in terminals or (Snap-in terminals)

\* Substitute BSF or SSF for XXX  
BSF - Bolt-In Switched and Fused  
SSF - Snap-In Switched and Fused

# Switched and Fused Filtered Power Entry Modules

For Medical or General Purpose Applications

## Temperature Characteristics



## Dimensions 66/67-BSF Series



## 66/67-SSF Series



## Common Mode



### 0.01 mA Leakage Current



### 0.075 and 0.1 mA Leakage Current



## Normal Mode



### 0.01 mA Leakage Current



### 0.075 and 0.1 mA Leakage Current



# Switched and Fused Filtered Power Entry Modules

## Dual Fuse for European Applications



### 68-BSF Series

#### Features

- Dual fuse for European applications
- Fuse holder and double pole power ON/OFF switch provides a convenient/compact package
- Suitable for products that must conform to FCC and FTZ requirements
- Meets over voltage category II of IEC 664 and complies with IEC 950
- Metal case provides effective EMI shielding
- IEC connector meets the safety standards of most certifying agencies
- Easy access fuse drawer
- Flange-mounted
- UL, CSA, and SEMKO approved
- Designed to be in accordance with VDE 0565, part 3
- Operating temperature: -25°C to +85°C (including temperature rise, see graph on page PF43)

#### Applications

- Computers and peripheral equipment
- Electronic equipment
- Digital equipment
- Measuring and testing instruments
- Telecommunications equipment

#### Circuit Diagram



#### Specifications

| Model           | Rated Voltage (@ 50/60Hz) | Rated Current | Leakage Current (Max.) | Capacitance     |                 |                 |                 | Inductance (L <sub>1</sub> ) | Temperature Rise (Max.) |
|-----------------|---------------------------|---------------|------------------------|-----------------|-----------------|-----------------|-----------------|------------------------------|-------------------------|
|                 |                           |               |                        | C <sub>Y1</sub> | C <sub>Y2</sub> | C <sub>X1</sub> | C <sub>X2</sub> |                              |                         |
| 68-BSF-020-3-01 | 250VAC                    | 2A            | 0.35mA                 | 2200pF          | 2200pF          | 0.1uF           | 0.1uF           | 10.5mH                       | 45°C                    |
| 68-BSF-020-3-04 |                           |               |                        |                 |                 | 0.22uF          | 0.22uF          |                              |                         |
| 68-BSF-040-3-01 |                           | 4A            |                        |                 |                 | 0.1uF           | 0.1uF           | 4.2mH                        |                         |
| 68-BSF-040-3-04 |                           |               |                        |                 |                 | 0.22uF          | 0.22uF          |                              |                         |
| 68-BSF-060-3-01 |                           | 6A            |                        |                 |                 | 1.6mH           | 0.1uF           | 0.1uF                        |                         |
| 68-BSF-060-3-04 |                           |               |                        |                 |                 |                 | 0.22uF          | 0.22uF                       |                         |

Note: Test Voltage 1500VAC one minute, line to ground  
 Insulation Resistance: 300 MΩ min. at 500VDC  
 Voltage Drop: 1V max. at rated current  
 Weight: 130g  
 Inlet: Compatible with IEC-320  
 B(S) = Bolt-in terminals

# Switched and Fused Filtered Power Entry Modules

## Dual Fuse for European Applications

### 68-BSF Series



# PCB Power Filters Miniature Printed Circuit Board

## 61-MPC Series



Tested and found to be  
IAW VDE 0565 Part 3

### Features

- Miniature general purpose PCB mounted filter
- Requires minimal PCB real estate space
- Low cost
- Designed for two wire cord systems
- For three wire cord systems, Y capacitors can be attached externally
- Operating temperature: -25°C to +85°C (including temperature rise, see graph on page PF45)

### Applications

- Personal computers and peripherals
- Digital equipment
- Measuring instruments and medical equipment
- TV & VCR monitors and display units
- Home appliances



### Circuit Diagram



## Specifications

| Model           | Rated Voltage (@ 50/60Hz) | Rated Current | Leakage Current (Max.) | Capacitance     |                 | Inductance (L <sub>1</sub> ) | Temperature Rise (Max.) |
|-----------------|---------------------------|---------------|------------------------|-----------------|-----------------|------------------------------|-------------------------|
|                 |                           |               |                        | C <sub>X1</sub> | C <sub>X2</sub> |                              |                         |
| 61-MPC-010-1-11 | 250VAC                    | 1A            | 0.1mA                  | 0.1uF           | 0.1uF           | 11mH                         | 40°C                    |
| 61-MPC-016-1-11 |                           | 1.6A          |                        |                 |                 | 6.0mH                        |                         |
| 61-MPC-025-1-11 |                           | 2.5A          |                        |                 |                 | 2.4mH                        |                         |
| 61-MPC-036-1-11 |                           | 3.6A          |                        |                 |                 | 1.2mH                        |                         |

Note: Test voltage: 1500VAC one minute, line to ground  
 Insulation resistance: 300 Mohm min. at 500VDC  
 Voltage drop: 1V max. at rated current  
 Weight: 17.5g

# PCB Power Filters Miniature Printed Circuit Board

## 61-MPC Series



Dimensions in inches (mm)

### Common Mode



### 61-MPC



### 61-MPC



### Temperature Characteristics



### Normal Mode



### 61-MPC



# Power Entry Modules Bolt-in Right Angle Terminals

for PCB Applications

## 60-BPP Series



Tested and found to be  
IAW VDE 0565 Part 3

### Features

- Ideally suited for products that must conform to FCC part 15 regulations
- Metal case offers high performance
- Meets over voltage of IEC 664 category II and complies with IEC 950
- Uses IEC connector that meets most safety standards Solder lug, Fast-on tab styles available (see page PF18)
- PCB mounting style minimizes space and provides economical installation
- Operating temperature: -25°C to +85°C (including temperature rise, see graph on page PF47)
- UL approved low leakage version also available

### Applications

- Digital equipment
- Personal computers and peripherals
- Measuring instruments
- Monitor and display units



### Circuit Diagram



### Specifications

| Model          | Rated Voltage<br>(@ 50/60Hz) | Rated Current | Leakage Current<br>(Max.) | Capacitance    |                | Inductance<br>(L <sub>1</sub> ) | Temperature<br>Rise (Max.) |      |
|----------------|------------------------------|---------------|---------------------------|----------------|----------------|---------------------------------|----------------------------|------|
|                |                              |               |                           | C <sub>Y</sub> | C <sub>X</sub> |                                 |                            |      |
| 60-BPP-010-3-2 | 250VAC                       | 1A            | 0.35mA                    | 2200pF         | 0.022uF        | 6.0mH                           | 30°C                       |      |
| 60-BPP-010-3-4 |                              |               |                           |                | 0.047uF        |                                 |                            |      |
| 60-BPP-010-5-2 |                              |               | 0.50mA                    | 3300pF         | 0.022uF        |                                 |                            |      |
| 60-BPP-010-5-4 |                              |               |                           |                | 0.047uF        |                                 |                            |      |
| 60-BPP-020-3-2 |                              | 2A            | 0.35mA                    | 2200pF         | 0.022uF        | 2.4mH                           |                            |      |
| 60-BPP-020-3-4 |                              |               |                           |                | 0.047uF        |                                 |                            |      |
| 60-BPP-020-5-2 |                              |               | 0.50mA                    | 3300pF         | 0.022uF        |                                 |                            |      |
| 60-BPP-020-5-4 |                              |               |                           |                | 0.047uF        |                                 |                            |      |
| 60-BPP-030-3-2 |                              | 3A            | 0.35mA                    | 2200pF         | 0.022uF        | 1.2mH                           |                            |      |
| 60-BPP-030-3-4 |                              |               |                           |                | 0.047uF        |                                 |                            |      |
| 60-BPP-030-5-2 |                              |               | 0.50mA                    | 3300pF         | 0.022uF        |                                 |                            |      |
| 60-BPP-030-5-4 |                              |               |                           |                | 0.047uF        |                                 |                            |      |
| 60-BPP-060-3-2 |                              | 6A            | 0.35mA                    | 2200pF         | 0.022uF        | 0.53mH                          |                            | 45°C |
| 60-BPP-060-3-4 |                              |               |                           |                | 0.047uF        |                                 |                            |      |
| 60-BPP-060-5-2 |                              |               | 0.50mA                    | 3300pF         | 0.022uF        |                                 |                            |      |
| 60-BPP-060-5-4 |                              |               |                           |                | 0.047uF        |                                 |                            |      |

Note: Test voltage: 1500VAC one minute, line to ground  
 Insulation resistance: 300 Mohm min. at 500VDC  
 Voltage drop: 1V max. at rated current  
 Weight: 50g  
 Input: Compatible with IEC-320



# Power Entry Modules Bolt-in Right Angle Terminals

for PCB Applications

## 60-BPP Series

### Temperature Characteristics



### 60-BPP PCB Mounting Type



### Common Mode



#### 60-BPP-010;-020



#### 60-BPP-030;-060



### Normal Mode



#### 60-BPP-010;-020



#### 60-BPP-030;-060



# Power Entry Modules High Frequency Attenuation

Bolt-in for PCB Applications

## 60-BHP Series



Tested and found to be  
IAW VDE 0565 Part 3

### Features

- Ideally suited for products that must conform to FCC part 15 regulations
- Metal cased filter offers high performance
- Meets over voltage of IEC 664 category II and complies with IEC 950
- Solder lug, Fast-on tab styles available (see page PF20)
- PCB mounting minimizes space and provides economical installation
- Excellent filtering characteristics for high frequencies
- Earth coil standard
- Operating temperature: -25°C to +85°C (including temperature rise, see graph on page PF49)

### Applications

- Digital equipment
- Personal computers and peripherals
- Measuring instruments
- Monitor and display units



### Circuit Diagram

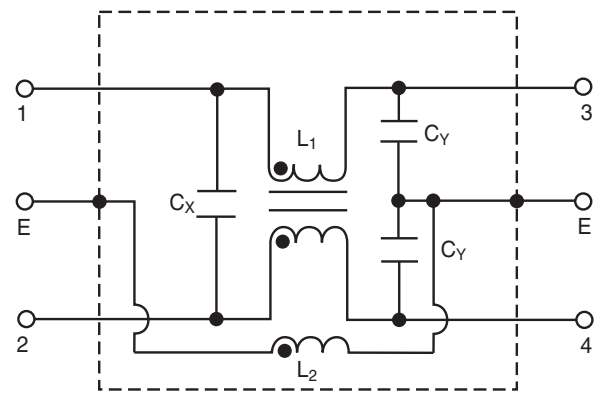

### Specifications

| Model           | Rated Voltage<br>(@ 50/60Hz) | Rated Current | Leakage Current<br>(Max.) | Capacitance    |                | Inductance        |                   | Temperature Rise (Max.) |      |
|-----------------|------------------------------|---------------|---------------------------|----------------|----------------|-------------------|-------------------|-------------------------|------|
|                 |                              |               |                           | C <sub>Y</sub> | C <sub>X</sub> | (L <sub>1</sub> ) | (L <sub>2</sub> ) |                         |      |
| 60-BHP-010-3-11 | 250VAC                       | 1A            | 0.35mA                    | 2200pF±20%     | 0.1uF±20%      | 6mH               | 18.3 uH           | 30°C                    |      |
| 60-BHP-010-3-4  |                              |               |                           |                | .047uF±20%     |                   |                   |                         |      |
| 60-BHP-010-5-11 |                              |               |                           |                | 0.1uF±20%      |                   |                   |                         |      |
| 60-BHP-010-5-4  |                              |               |                           |                | .047uF±20%     |                   |                   |                         |      |
| 60-BHP-020-3-11 |                              | 2A            | 0.35mA                    | 2200pF±20%     | 0.1uF±20%      | 2.4mH             |                   |                         |      |
| 60-BHP-020-3-4  |                              |               |                           |                | .047uF±20%     |                   |                   |                         |      |
| 60-BHP-020-5-11 |                              |               |                           |                | 0.1uF±20%      |                   |                   |                         |      |
| 60-BHP-020-5-4  |                              |               |                           |                | .047uF±20%     |                   |                   |                         |      |
| 60-BHP-030-3-11 |                              | 3A            | 0.35mA                    | 2200pF±20%     | 0.1uF±20%      | 1.2mH             |                   |                         |      |
| 60-BHP-030-3-4  |                              |               |                           |                | .047uF±20%     |                   |                   |                         |      |
| 60-BHP-030-5-11 |                              |               |                           |                | 0.1uF±20%      |                   |                   |                         |      |
| 60-BHP-030-5-4  |                              |               |                           |                | .047uF±20%     |                   |                   |                         |      |
| 60-BHP-060-3-11 |                              | 6A            | 0.35mA                    | 2200pF±20%     | 0.1uF±20%      | 0.53mH            |                   |                         | 45°C |
| 60-BHP-060-3-4  |                              |               |                           |                | .047uF±20%     |                   |                   |                         |      |
| 60-BHP-060-5-11 |                              |               |                           |                | 0.1uF±20%      |                   |                   |                         |      |
| 60-BHP-060-5-4  |                              |               |                           |                | .047uF±20%     |                   |                   |                         |      |

Note: Test voltage: 1500VAC one minute, line to ground  
 Insulation resistance: 300 Mohm min. at 500VDC  
 Voltage drop: 1V max. at rated current  
 Weight: 50g  
 Input: Compatible with IEC-320

# Power Entry Modules High Frequency Attenuation

Bolt-in for PCB Applications

## 60-BHP Series



### 60-BHP PCB Mounting Type





Компания «ЭлектроПласт» предлагает заключение долгосрочных отношений при поставках импортных электронных компонентов на взаимовыгодных условиях!

Наши преимущества:

- Оперативные поставки широкого спектра электронных компонентов отечественного и импортного производства напрямую от производителей и с крупнейших мировых складов;
- Поставка более 17-ти миллионов наименований электронных компонентов;
- Поставка сложных, дефицитных, либо снятых с производства позиций;
- Оперативные сроки поставки под заказ (от 5 рабочих дней);
- Экспресс доставка в любую точку России;
- Техническая поддержка проекта, помощь в подборе аналогов, поставка прототипов;
- Система менеджмента качества сертифицирована по Международному стандарту ISO 9001;
- Лицензия ФСБ на осуществление работ с использованием сведений, составляющих государственную тайну;
- Поставка специализированных компонентов (Xilinx, Altera, Analog Devices, Intersil, Interpoint, Microsemi, Aeroflex, Peregrine, Syfer, Eurofarad, Texas Instrument, Miteq, Cobham, E2V, MA-COM, Hittite, Mini-Circuits, General Dynamics и др.);

Помимо этого, одним из направлений компании «ЭлектроПласт» является направление «Источники питания». Мы предлагаем Вам помощь Конструкторского отдела:

- Подбор оптимального решения, техническое обоснование при выборе компонента;
- Подбор аналогов;
- Консультации по применению компонента;
- Поставка образцов и прототипов;
- Техническая поддержка проекта;
- Защита от снятия компонента с производства.



#### Как с нами связаться

**Телефон:** 8 (812) 309 58 32 (многоканальный)

**Факс:** 8 (812) 320-02-42

**Электронная почта:** [org@eplast1.ru](mailto:org@eplast1.ru)

**Адрес:** 198099, г. Санкт-Петербург, ул. Калинина, дом 2, корпус 4, литера А.