

# Amphenol Pcd



## 75P CLAMP



# 75P CLAMP

## Description:

Engineered for lean manufacturing and high performance, the 75P Clamp was designed as a one-for-one replacement to outperform industry standard metal clamps (i.e. AS21919). Featuring benefits such as a locking feature, butterfly stacking, weight savings, durable PEEK polymer band material and multiple cushion material options that are non-conductive and non-corrosive, the 75P Clamp is a versatile solution for anyone looking to reduce weight and installation time.

## Specifications

### Materials

Band: PEEK per Mil-P-46183 Type I

Cushion: See Cushion Material Codes on next pg.

### Environmental

Operating Temperature: -55°C to 70°C

Temperature Variation per RTCA DO-160G, Category A: -55°C to 85°C at 10°C/min

Humidity per RTCA DO-160G, Category B: 240h at 38°C/85%RH to 65°C/95%RH

### Mechanical

Operational Shock and Crash Safety as per RTCA DO-160G, Category B: 6g Shock, 20g Crash Safety

Vibration per RTCA DO-160G: Random Vibration, Curve E1, 11grms & High Level, Short Duration, Curve P, ±10g sinusoidal from 10 to 250Hz

Static Load: All sizes exceed 50lbf load at -55°C, 23°C, and 70°C

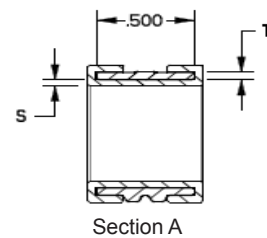
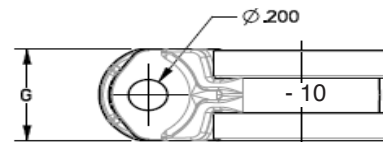
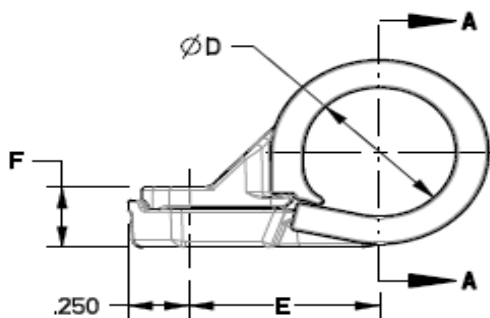

## Part Number Callout

|           |    |   |
|-----------|----|---|
| ALBPCL75P | 10 | E |
|-----------|----|---|

Basic Part Number

Dash Size

Cushion Material Code

# 75P CLAMP

## General Dimensions

| Part Number  | Dash # | ØD    |       | E     |       | F    |       | G    |       | T     |       | S    |      | Weight |       |
|--------------|--------|-------|-------|-------|-------|------|-------|------|-------|-------|-------|------|------|--------|-------|
|              |        | Inch  | mm    | Inch  | mm    | Inch | mm    | Inch | mm    | Inch  | mm    | Inch | mm   | lbs.   | grams |
| ALBPCL75P02X | -02    | .125  | 3.18  | .477  | 12.12 | .160 | 4.06  | .600 | 15.24 | .030  | .76   | .040 | 1.02 | .0043  | 1.95  |
| ALBPCL75P03X | -03    | .188  | 4.78  | .518  | 13.16 | .180 | 4.57  |      |       | .035  | .89   |      |      | .0052  | 2.36  |
| ALBPCL75P04X | -04    | .250  | 6.35  | .549  | 13.94 | .200 | 5.08  |      |       | .040  | 1.02  |      |      | .0064  | 2.90  |
| ALBPCL75P05X | -05    | .313  | 7.95  | .580  | 14.73 |      |       |      |       |       |       |      |      | .0073  | 3.31  |
| ALBPCL75P06X | -06    | .375  | 9.53  | .612  | 15.54 | .240 | 6.10  |      |       | .040  | 1.02  |      |      | .0081  | 3.67  |
| ALBPCL75P07X | -07    | .438  | 11.13 | .643  | 16.33 |      |       |      |       |       |       |      |      | .0089  | 4.04  |
| ALBPCL75P08X | -08    | .500  | 12.70 | .674  | 17.12 | .280 | 7.11  |      |       | .050  | 1.27  |      |      | .0097  | 4.40  |
| ALBPCL75P09X | -09    | .563  | 14.30 | .752  | 19.10 |      |       |      |       |       |       |      |      | .0118  | 5.35  |
| ALBPCL75P10X | -10    | .625  | 15.88 | .783  | 19.89 | .320 | 8.13  |      |       | .050  | 1.27  |      |      | .0126  | 5.72  |
| ALBPCL75P11X | -11    | .688  | 17.48 | .834  | 21.18 |      |       |      |       |       |       |      |      | .0156  | 7.08  |
| ALBPCL75P12X | -12    | .750  | 19.05 | .865  | 21.97 | .360 | 9.14  | .060 | 1.52  | .0166 | 7.53  |      |      |        |       |
| ALBPCL75P13X | -13    | .813  | 20.65 | .897  | 22.78 |      |       |      |       | .0186 | 8.44  |      |      |        |       |
| ALBPCL75P14X | -14    | .875  | 22.23 | .928  | 23.57 |      |       |      |       | .0196 | 8.89  |      |      |        |       |
| ALBPCL75P15X | -15    | .938  | 23.83 | .959  | 24.36 |      |       |      |       | .0208 | 9.43  |      |      |        |       |
| ALBPCL75P16X | -16    | 1.000 | 25.40 | .990  | 25.15 | .375 | 9.53  | .070 | 1.78  | .0218 | 9.89  |      |      |        |       |
| ALBPCL75P17X | -17    | 1.063 | 27.00 | 1.022 | 25.96 |      |       |      |       | .0229 | 10.39 |      |      |        |       |
| ALBPCL75P18X | -18    | 1.125 | 28.58 | 1.082 | 27.48 | .400 | 10.16 | .070 | 1.78  | .0245 | 11.11 |      |      |        |       |
| ALBPCL75P19X | -19    | 1.188 | 30.18 | 1.113 | 28.27 |      |       |      |       | .0275 | 12.47 |      |      |        |       |
| ALBPCL75P20X | -20    | 1.250 | 31.75 | 1.144 | 29.06 |      |       |      |       | .0286 | 12.97 |      |      |        |       |
| ALBPCL75P21X | -21    | 1.313 | 33.35 | 1.176 | 29.87 |      |       |      |       | .0297 | 13.47 |      |      |        |       |
| ALBPCL75P22X | -22    | 1.375 | 34.93 | 1.207 | 30.66 | .400 | 10.16 | .080 | 2.03  | .0326 | 14.79 |      |      |        |       |
| ALBPCL75P23X | -23    | 1.438 | 36.53 | 1.238 | 31.45 |      |       |      |       | .0337 | 15.29 |      |      |        |       |
| ALBPCL75P24X | -24    | 1.500 | 38.10 | 1.269 | 32.23 |      |       |      |       | .0349 | 15.83 |      |      |        |       |

## Cushion Materials

Cushions for the 75P Clamp are available in a wide variety of rubber materials, including Ethylene Propylene, Nitrile, Chloroprene, Silicone, and Fluorosilicone. Cushion profile, materials, and color-coding are the same as metal clamps for maximum compatibility with any current application and environment.

|   |   |   |  |   |
|---|---|---|--|---|
|  |  |  |  |  |
| EPR (E)   | Nitrile (N)   | Chloroprene (G)   | Silicone (S)   | Fluorosilicone (J)  |

## 75P Clamp Diagram

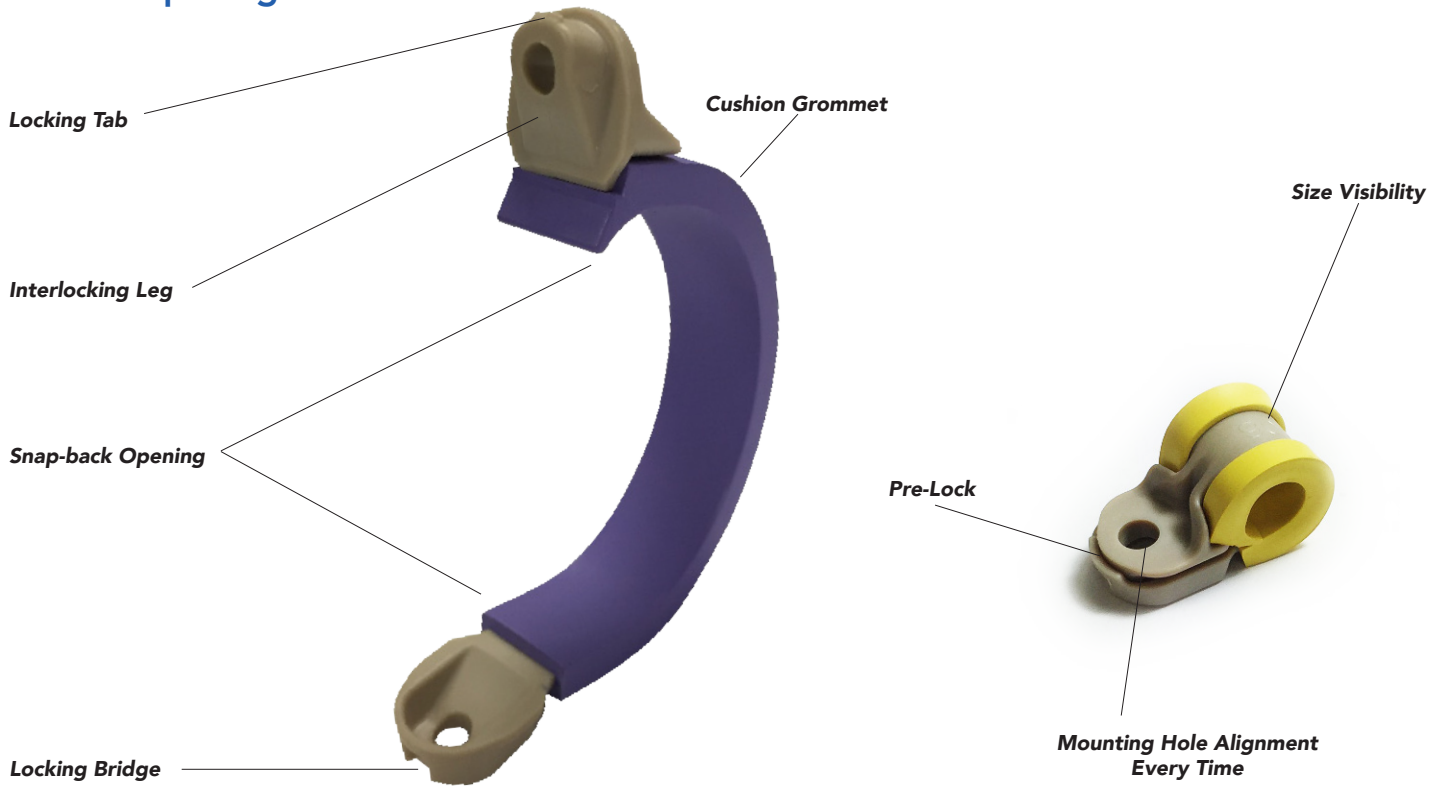

## Cushion Material Codes

| Code | Material  | Color                  | Application   |
|------|---|------------------------|---|
| E    | Ethylene Propylene per AMS 3253                           | Purple                 | For use in areas exposed to phosphate ester hydraulic fluid (Skydrol). Excellent ozone resistance. Not resistant to petroleum-based fluids.   |
| N    | Nitrile per AMS 3224                                      | Yellow                 | For use primarily in fuel immersion and with fuel vapors. Good ozone resistance. Not resistant to phosphate ester based fluids. Not for use on titanium tubing.   |
| G    | Chloroprene per AMS 3209                                  | Black with Blue Stripe | For general use in areas exposed to petroleum based hydraulic fluids and occasional fuel splash. Excellent ozone resistance. Not resistant to phosphate ester based fluids. Not for use on titanium tubing. |
| S    | Silicone per AMS 3310                                     | White                  | For elevated temperature usage in areas exposed to phosphate ester and other synthetic fluids. Unaffected by ozone. Not resistant to petroleum based fluids.  |
| J    | Fluorosilicone per Mil-R-25988 Type II, Class 1, Grade 60 | Blue                   | For elevated temperature usage in areas exposed to petroleum based fluids. Unaffected by ozone. Not resistant to phosphate ester based fluids.  |

## One-Handed Installation

The 75P Clamp is built with ease of installation and ergonomics in mind featuring interlocking legs and a snapping pre-lock. The interlocking legs ensure that the mounting holes always stay in perfect alignment while a pre-lock feature snaps the clamp into a closed position. With these two features, a one-handed installation is made possible, which benefits installers in obstructed access areas.



**AS21919**

The labor intensive installation process for metal clamps requires two hands to physically bend and shape the clamp both open and closed around the bundle. The reshaping of the clamp often leads to misalignment of mounting holes, making it difficult to hold the clamp in a closed position and install a fastener at the same time. This contributes to repetitive stress injury.

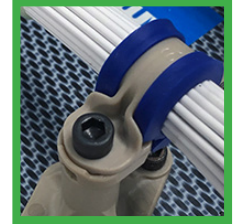
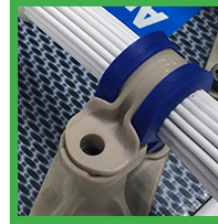
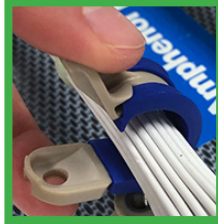

**75P Clamp Series**

- Using flexible yet strong PEEK material the 75P Clamp is easily placed around the wire bundle while still retaining optimal shape.
- The interlocking legs and pre-lock allow installers to simply pinch and snap the clamp into a closed position around the bundle. The pinching force falls within recommended limits to prevent repetitive use injury.
- With the clamp already held in a closed position and mounting holes pre-aligned by the snapping pre-lock, installers have both hands free to insert fasteners and mount the clamp to the structure.

## 75P Clamp vs CRES & Alum

| Size | AS21919 |       |      |       | ALBPCL75P |       | % Weight Savings |          |
|------|---------|-------|------|-------|-----------|-------|------------------|----------|
|      | CRES    |       | Alum |       | 75P Clamp |       | vs. CRES         | vs. Alum |
|      | lbs.    | grams | lbs. | grams | lbs.      | grams |                  |          |
| -02  | .008    | 3.63  | .005 | 2.27  | .004      | 1.81  | -46%             | -14%     |
| -03  | .010    | 4.54  | .006 | 2.72  | .005      | 2.27  | -48%             | -13%     |
| -04  | .011    | 4.99  | .007 | 3.18  | .006      | 2.72  | -42%             | -9%      |
| -05  | .012    | 5.44  | .008 | 3.63  | .007      | 3.18  | -39%             | -9%      |
| -06  | .014    | 6.35  | .009 | 4.08  | .008      | 3.63  | -42%             | -10%     |
| -07  | .016    | 7.26  | .010 | 4.54  | .009      | 4.08  | -44%             | -11%     |
| -08  | .018    | 8.16  | .010 | 4.80  | .010      | 4.54  | -46%             | -3%      |
| -09  | .022    | 9.98  | .013 | 5.90  | .012      | 5.44  | -46%             | -9%      |
| -10  | .027    | 12.25 | .016 | 7.26  | .013      | 5.90  | -53%             | -21%     |
| -11  | .029    | 13.15 | .019 | 8.62  | .016      | 7.26  | -46%             | -18%     |
| -12  | .031    | 14.06 | .021 | 9.53  | .017      | 7.71  | -46%             | -21%     |
| -13  | .033    | 14.97 | .022 | 9.98  | .019      | 8.62  | -44%             | -15%     |
| -14  | .035    | 15.88 | .023 | 10.43 | .020      | 9.07  | -44%             | -15%     |
| -15  | .037    | 16.78 | .025 | 11.34 | .021      | 9.53  | -44%             | -17%     |
| -16  | .039    | 17.69 | .027 | 12.25 | .022      | 9.98  | -44%             | -19%     |
| -17  | .043    | 19.50 | .030 | 13.61 | .023      | 10.43 | -47%             | -24%     |
| -18  | .046    | 20.87 | .032 | 14.51 | .025      | 11.34 | -47%             | -23%     |
| -19  | .049    | 22.23 | .034 | 15.42 | .028      | 12.70 | -44%             | -19%     |
| -20  | .052    | 23.59 | .036 | 16.33 | .029      | 13.15 | -45%             | -21%     |
| -21  | .055    | 24.95 | .038 | 17.24 | .030      | 13.61 | -46%             | -22%     |
| -22  | .058    | 26.31 | .039 | 17.69 | .033      | 14.97 | -44%             | -16%     |
| -23  | .061    | 27.67 | .041 | 18.60 | .034      | 15.42 | -45%             | -18%     |
| -24  | .063    | 28.58 | .043 | 19.50 | .035      | 15.88 | -45%             | -19%     |



**75P Clamp**

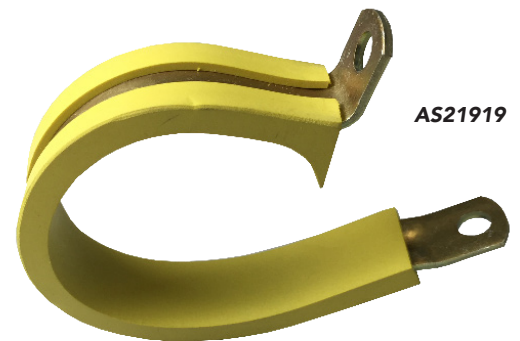

**AS21919**



# AMPHENOL PCD PRODUCTS



BACKSHELLS



CABLE SOLUTIONS



CIRCULAR

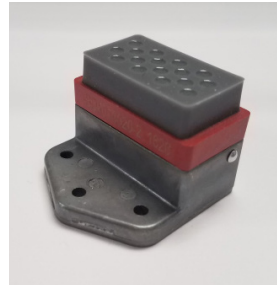

GROUND BLOCKS



LUMINUS



MILITARY AUDIO/POWER



PEGASUS SERIES



RECTANGULAR



RUGGED SOLUTIONS



SIM



SOLARIS



SYSTEM ATTACHMENTS

## Amphenol Pcd

[www.amphenolpcd.com](http://www.amphenolpcd.com)

U.S. PATENT NOTICE

The product specialized in this brochure is covered by U.S. Patent UA9.829.119B2



Компания «ЭлектроПласт» предлагает заключение долгосрочных отношений при поставках импортных электронных компонентов на взаимовыгодных условиях!

Наши преимущества:

- Оперативные поставки широкого спектра электронных компонентов отечественного и импортного производства напрямую от производителей и с крупнейших мировых складов;
- Поставка более 17-ти миллионов наименований электронных компонентов;
- Поставка сложных, дефицитных, либо снятых с производства позиций;
- Оперативные сроки поставки под заказ (от 5 рабочих дней);
- Экспресс доставка в любую точку России;
- Техническая поддержка проекта, помощь в подборе аналогов, поставка прототипов;
- Система менеджмента качества сертифицирована по Международному стандарту ISO 9001;
- Лицензия ФСБ на осуществление работ с использованием сведений, составляющих государственную тайну;
- Поставка специализированных компонентов (Xilinx, Altera, Analog Devices, Intersil, Interpoint, Microsemi, Aeroflex, Peregrine, Syfer, Eurofarad, Texas Instrument, Miteq, Cobham, E2V, MA-COM, Hittite, Mini-Circuits, General Dynamics и др.);

Помимо этого, одним из направлений компании «ЭлектроПласт» является направление «Источники питания». Мы предлагаем Вам помощь Конструкторского отдела:

- Подбор оптимального решения, техническое обоснование при выборе компонента;
- Подбор аналогов;
- Консультации по применению компонента;
- Поставка образцов и прототипов;
- Техническая поддержка проекта;
- Защита от снятия компонента с производства.



#### Как с нами связаться

**Телефон:** 8 (812) 309 58 32 (многоканальный)

**Факс:** 8 (812) 320-02-42

**Электронная почта:** [org@eplast1.ru](mailto:org@eplast1.ru)

**Адрес:** 198099, г. Санкт-Петербург, ул. Калинина, дом 2, корпус 4, литера А.