

### FEATURES

- Single-channel, 256-/1024-position resolution
- 20 k $\Omega$ , 50 k $\Omega$ , and 100 k $\Omega$  nominal resistance
- Maximum  $\pm 1\%$  nominal resistor tolerance error (resistor performance mode)
- 20-times programmable wiper memory
- Rheostat mode temperature coefficient: 35 ppm/ $^{\circ}\text{C}$
- Voltage divider temperature coefficient: 5 ppm/ $^{\circ}\text{C}$
- +9 V to +33 V single-supply operation
- $\pm 9$  V to  $\pm 16.5$  V dual-supply operation
- SPI-compatible serial interface
- Wiper setting readback
- Power-on refreshed from 20-TP memory

### APPLICATIONS

- Mechanical potentiometer replacement
- Instrumentation: gain and offset adjustment
- Programmable voltage-to-current conversion
- Programmable filters, delays, and time constants
- Programmable power supply
- Low resolution DAC replacement
- Sensor calibration

### GENERAL DESCRIPTION

The AD5291 and AD5292 are single-channel, 256-/1024-position digital potentiometers<sup>1</sup> that combine industry leading variable resistor performance with nonvolatile memory (NVM) in a compact package. These devices are capable of operating across a wide voltage range, supporting both dual supply operation at  $\pm 10.5$  V to  $\pm 16.5$  V and single supply operation at +21 V to +33 V, while ensuring less than 1% end-to-end resistor tolerance error and offering 20-time programmable (20-TP) memory.

The guaranteed industry leading low resistor tolerance error feature simplifies open-loop applications as well as precision calibration and tolerance matching applications.

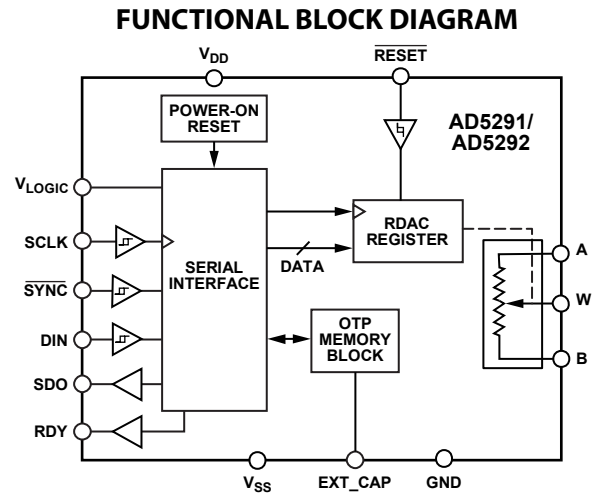

Figure 1.

The AD5291 and AD5292 device wiper settings are controllable through the SPI digital interface. Unlimited adjustments are allowed before programming the resistance value into the 20-TP memory. The AD5291 and AD5292 do not require any external voltage supply to facilitate fuse blow, and there are 20 opportunities for permanent programming. During 20-TP activation, a permanent blow fuse command freezes the wiper position (analogous to placing epoxy on a mechanical trimmer).

The AD5291 and AD5292 are available in a compact 14-lead TSSOP package. The part is guaranteed to operate over the extended industrial temperature range of  $-40^{\circ}\text{C}$  to  $+105^{\circ}\text{C}$ .

<sup>1</sup> The terms digital potentiometer and RDAC are used interchangeably.

#### Rev. D

Information furnished by Analog Devices is believed to be accurate and reliable. However, no responsibility is assumed by Analog Devices for its use, nor for any infringements of patents or other rights of third parties that may result from its use. Specifications subject to change without notice. No license is granted by implication or otherwise under any patent or patent rights of Analog Devices. Trademarks and registered trademarks are the property of their respective owners.

## TABLE OF CONTENTS

|  |    |   |    |
|--|----|---|----|
| Features .....                                   | 1  | 20-TP Memory .....                                    | 23 |
| Applications.....                                | 1  | Write Protection .....                                | 23 |
| Functional Block Diagram .....                   | 1  | Basic Operation .....                                 | 24 |
| General Description .....                        | 1  | 20-TP Readback and Spare Memory Status .....          | 24 |
| Revision History .....                           | 2  | Shutdown Mode .....                                   | 24 |
| Specifications.....                              | 3  | Resistor Performance Mode.....                        | 25 |
| Electrical Characteristics—AD5291 .....          | 3  | Reset .....   | 25 |
| Resistor Performance Mode Code Range .....       | 4  | SDO Pin and Daisy-Chain Operation.....                | 25 |
| Electrical Characteristics—AD5292 .....          | 6  | RDAC Architecture.....                                | 25 |
| Resistor Performance Mode Code Range .....       | 7  | Programming the Variable Resistor.....                | 26 |
| Interface Timing Specifications.....             | 8  | Programming the Potentiometer Divider .....           | 26 |
| Absolute Maximum Ratings.....                    | 10 | EXT_CAP Capacitor.....                                | 27 |
| Thermal Resistance .....                         | 10 | Terminal Voltage Operating Range .....                | 27 |
| ESD Caution.....                                 | 10 | Applications Information .....                        | 28 |
| Pin Configuration and Function Descriptions..... | 11 | High Voltage DAC.....                                 | 28 |
| Typical Performance Characteristics .....        | 12 | Programmable Voltage Source with Boosted Output ..... | 28 |
| Test Circuits.....                               | 21 | High Accuracy DAC .....                               | 28 |
| Theory of Operation .....                        | 22 | Variable Gain Instrumentation Amplifier .....         | 28 |
| Serial Data Interface.....                       | 22 | Audio Volume Control .....                            | 29 |
| Shift Register .....                             | 22 | Outline Dimensions .....                              | 30 |
| RDAC Register.....                               | 22 | Ordering Guide .....                                  | 30 |

## REVISION HISTORY

### 9/10—Rev. C to Rev. D

Changes to SDO Pin and Daisy-Chain Operation Section..... 25

### 3/10—Rev. B to Rev. C

Changes to Revision History..... 2

Changes to Figure 3 and Figure 4 Captions .....

### 3/10—Rev. A to Rev. B

Changes to Data Sheet Title .....

Changes to General Description Section .....

Changes to Theory of Operation Section.....

### 12/09—Rev. 0 to Rev. A

Added 50 k $\Omega$  and 100 k $\Omega$  specifications .....

Changes to Features Section.....

Changes to Table 1 .....

Changes to Table 2.....

Added Table 3 .....

Changes to Table 4.....

Changes to Table 5.....

Added Table 6 .....

Change to Table 7 .....

Changes to Absolute Maximum Rating Section .....

Changes Table 9 .....

Changes to Typical Performance Characteristics Section .....

Changes to Ordering Guide .....

### 4/09—Revision 0: Initial Version

# SPECIFICATIONS

## ELECTRICAL CHARACTERISTICS—AD5291

$V_{DD} = 21\text{ V to }33\text{ V}$ ,  $V_{SS} = 0\text{ V}$ ;  $V_{DD} = 10.5\text{ V to }16.5\text{ V}$ ,  $V_{SS} = -10.5\text{ V to }-16.5\text{ V}$ ;  $V_{LOGIC} = 2.7\text{ V to }5.5\text{ V}$ ,  $V_A = V_{DD}$ ,  $V_B = V_{SS}$ ,  
 $-40^\circ\text{C} < T_A < +105^\circ\text{C}$ , unless otherwise noted.

Table 1.

| Parameter   | Symbol  | Conditions  | Min               | Typ <sup>1</sup>        | Max         | Unit                  |
|---|---|---|-------------------|-------------------------|-------------|-----------------------|
| DC CHARACTERISTICS—RHEOSTAT MODE                      |   |   |                   |                         |             |                       |
| Resolution  | N   |   | 8                 |                         |             | Bits                  |
| Resistor Differential Nonlinearity <sup>2</sup>       | R-DNL   | $R_{WB}$ , $V_A = NC$   | -1                |                         | +1          | LSB                   |
| Resistor Integral Nonlinearity <sup>2</sup>           | R-INL   |   | -1                |                         | +1          | LSB                   |
| Nominal Resistor Tolerance (R-Perf Mode) <sup>3</sup> | $\Delta R_{AB}/R_{AB}$                        | See Table 2, Table 3  | -1                | $\pm 0.5$               | +1          | %                     |
| Nominal Resistor Tolerance (Normal Mode)              | $\Delta R_{AB}/R_{AB}$                        |   |                   | $\pm 7$                 |             | %                     |
| Resistance Temperature Coefficient <sup>4</sup>       | $(\Delta R_{AB}/R_{AB})/\Delta T \times 10^6$ | Code = full-scale; See Figure 38  |                   | 35                      |             | ppm/ $^\circ\text{C}$ |
| Wiper Resistance                                      | $R_W$   | Code = zero scale   |                   | 60                      | 100         | $\Omega$              |
| DC CHARACTERISTICS—POTENTIOMETER DIVIDER MODE         |   |   |                   |                         |             |                       |
| Resolution  | N   |   | 8                 |                         |             | Bits                  |
| Differential Nonlinearity <sup>5</sup>                | DNL   |   | -0.5              |                         | +0.5        | LSB                   |
| Integral Nonlinearity <sup>5</sup>                    | INL   |   | -0.5              |                         | +0.5        | LSB                   |
| Voltage Divider Temperature Coefficient <sup>4</sup>  | $(\Delta V_W/V_W)/\Delta T \times 10^6$       | Code = half-scale; See Figure 41  |                   | 1.5                     |             | ppm/ $^\circ\text{C}$ |
| Full-Scale Error                                      | $V_{WFSE}$                                    | Code = full scale   | -2                |                         | +0.25       | LSB                   |
| Zero-Scale Error                                      | $V_{WZSE}$                                    | Code = zero scale   | 0                 |                         | 2           | LSB                   |
| RESISTOR TERMINALS                                    |   |   |                   |                         |             |                       |
| Terminal Voltage Range <sup>6</sup>                   | $V_A$ , $V_B$ , $V_W$                         |   | $V_{SS}$          |                         | $V_{DD}$    | V                     |
| Capacitance A, Capacitance B <sup>4</sup>             | $C_A$ , $C_B$                                 | $f = 1\text{ MHz}$ , measured to GND,<br>code = half-scale  |                   | 85                      |             | pF                    |
| Capacitance W <sup>4</sup>                            | $C_W$   | $f = 1\text{ MHz}$ , measured to GND,<br>code = half-scale  |                   | 65                      |             | pF                    |
| Common-Mode Leakage Current <sup>4</sup>              | $I_{CM}$                                      | $V_A = V_B = V_W$   |                   | $\pm 1$                 |             | nA                    |
| DIGITAL INPUTS  |   |   |                   |                         |             |                       |
| Input Logic High <sup>4</sup>                         | $V_{IH}$                                      | JEDEC compliant<br>$V_{LOGIC} = 2.7\text{ V to }5.5\text{ V}$   | 2.0               |                         |             | V                     |
| Input Logic Low <sup>4</sup>                          | $V_{IL}$                                      | $V_{LOGIC} = 2.7\text{ V to }5.5\text{ V}$  |                   |                         | 0.8         | V                     |
| Input Current   | $I_{IL}$                                      | $V_{IN} = 0\text{ V or }V_{LOGIC}$  |                   |                         | $\pm 1$     | $\mu\text{A}$         |
| Input Capacitance <sup>4</sup>                        | $C_{IL}$                                      |   |                   | 5                       |             | pF                    |
| DIGITAL OUTPUTS (SDO and RDY)                         |   |   |                   |                         |             |                       |
| Output High Voltage <sup>4</sup>                      | $V_{OH}$                                      | $R_{PULL\_UP} = 2.2\text{ k}\Omega$ to $V_{LOGIC}$  | $V_{LOGIC} - 0.4$ |                         |             | V                     |
| Output Low Voltage <sup>4</sup>                       | $V_{OL}$                                      | $R_{PULL\_UP} = 2.2\text{ k}\Omega$ to $V_{LOGIC}$  |                   |                         | GND + 0.4 V | V                     |
| Three-State Leakage Current                           |   |   | -1                |                         | +1          | $\mu\text{A}$         |
| Output Capacitance <sup>4</sup>                       | $C_{OL}$                                      |   |                   | 5                       |             | pF                    |
| POWER SUPPLIES  |   |   |                   |                         |             |                       |
| Single-Supply Power Range                             | $V_{DD}$                                      | $V_{SS} = 0\text{ V}$   | 9                 |                         | 33          | V                     |
| Dual-Supply Power Range                               | $V_{DD}/V_{SS}$                               |   | $\pm 9$           |                         | $\pm 16.5$  | V                     |
| Positive Supply Current                               | $I_{DD}$                                      | $V_{DD}/V_{SS} = \pm 16.5\text{ V}$   |                   | 0.1                     | 2           | $\mu\text{A}$         |
| Negative Supply Current                               | $I_{SS}$                                      | $V_{DD}/V_{SS} = \pm 16.5\text{ V}$   | -2                | -0.1                    |             | $\mu\text{A}$         |
| Logic Supply Range                                    | $V_{LOGIC}$                                   |   | 2.7               |                         | 5.5         | V                     |
| Logic Supply Current                                  | $I_{LOGIC}$                                   | $V_{LOGIC} = 5\text{ V}$ ; $V_{IH} = 5\text{ V or }V_{IL} = \text{GND}$   |                   | 1                       | 10          | $\mu\text{A}$         |
| OTP Store Current <sup>4, 7</sup>                     | $I_{LOGIC\_PROG}$                             | $V_{IH} = 5\text{ V or }V_{IL} = \text{GND}$  |                   | 25                      |             | mA                    |
| OTP Read Current <sup>4, 8</sup>                      | $I_{LOGIC\_FUSE\_READ}$                       | $V_{IH} = 5\text{ V or }V_{IL} = \text{GND}$  |                   | 25                      |             | mA                    |
| Power Dissipation <sup>9</sup>                        | $P_{DISS}$                                    | $V_{IH} = 5\text{ V or }V_{IL} = \text{GND}$  |                   | 8                       | 110         | $\mu\text{W}$         |
| Power Supply Rejection Ratio                          | PSRR  | $\Delta V_{DD}/\Delta V_{SS} = \pm 15\text{ V} \pm 10\%$<br>$R_{AB} = 20\text{ k}\Omega$<br>$R_{AB} = 50\text{ k}\Omega$<br>$R_{AB} = 100\text{ k}\Omega$ |                   | 0.103<br>0.039<br>0.021 |             | %/%                   |

# AD5291/AD5292

| Parameter                                | Symbol            | Conditions  | Min | Typ <sup>1</sup>                                     | Max | Unit                             |
|--|-------------------|---|-----|--|-----|----------------------------------|
| DYNAMIC CHARACTERISTICS <sup>5, 10</sup> |                   |   |     |  |     |                                  |
| Bandwidth                                | BW                | −3 dB, code = half-scale<br>R <sub>AB</sub> = 20 kΩ<br>R <sub>AB</sub> = 50 kΩ<br>R <sub>AB</sub> = 100 kΩ  |     | 520<br>210<br>105                                    |     | kHz                              |
| Total Harmonic Distortion                | THD <sub>w</sub>  | V <sub>A</sub> = 1 V rms, V <sub>B</sub> = 0 V, f = 1 kHz<br>R <sub>AB</sub> = 20 kΩ<br>R <sub>AB</sub> = 50 kΩ<br>R <sub>AB</sub> = 100 kΩ   |     | −93<br>−101<br>−106                                  |     | dB                               |
| V <sub>w</sub> Settling Time             | t <sub>s</sub>    | V <sub>A</sub> = 30 V, V <sub>B</sub> = 0 V, ±0.5 LSB error band, initial code = zero scale, board capacitance = 170 pF<br>Code = full-scale, normal mode<br>Code = full-scale, R-Perf mode<br>Code = half-scale, normal mode<br>R <sub>AB</sub> = 20 kΩ<br>R <sub>AB</sub> = 50 kΩ<br>R <sub>AB</sub> = 100 kΩ<br>Code = half-scale, R-Perf mode<br>R <sub>AB</sub> = 20 kΩ<br>R <sub>AB</sub> = 50 kΩ<br>R <sub>AB</sub> = 100 kΩ |     | 750<br>2.5<br><br>2.5<br>7<br>14<br><br>5<br>9<br>16 |     | ns<br>μs<br>μs<br><br><br><br>μs |
| Resistor Noise Density                   | e <sub>N_WB</sub> | Code = half-scale, T <sub>A</sub> = 25°C, 0 kHz to 200 kHz<br>R <sub>AB</sub> = 20 kΩ<br>R <sub>AB</sub> = 50 kΩ<br>R <sub>AB</sub> = 100 kΩ  |     | <br><br><br>10<br>18<br>27                           |     | nV/√Hz                           |

<sup>1</sup> Typical values represent average readings at 25°C, V<sub>DD</sub> = 15 V, V<sub>SS</sub> = −15 V, and V<sub>LOGIC</sub> = 5 V.

<sup>2</sup> Resistor position nonlinearity error. R-INL is the deviation from an ideal value measured between the R<sub>WB</sub> at code 0x02 to code 0xFF or between R<sub>WA</sub> at code 0xFD to code 0x00. R-DNL measures the relative step change from ideal between successive tap positions. The specification is guaranteed in resistor performance mode, with a wiper current of 1 mA for V<sub>A</sub> < 12 V and 1.2 mA for V<sub>A</sub> ≥ 12 V.

<sup>3</sup> Resistor performance mode (see the Resistor Performance Mode section). The terms resistor performance mode and R-Perf mode are used interchangeably.

<sup>4</sup> Guaranteed by design and characterization, not subject to production test.

<sup>5</sup> INL and DNL are measured at V<sub>wB</sub> with the RDAC configured as a potentiometer divider similar to a voltage output DAC. V<sub>A</sub> = V<sub>DD</sub> and V<sub>B</sub> = 0 V. DNL specification limits of ±1 LSB maximum are guaranteed monotonic operating conditions.

<sup>6</sup> Resistor Terminal A, Resistor Terminal B, and Resistor Terminal W have no limitations on polarity with respect to each other. Dual-supply operation enables ground-referenced bipolar signal adjustment.

<sup>7</sup> Different from operating current; supply current for fuse program lasts approximately 550 μs.

<sup>8</sup> Different from operating current; supply current for fuse read lasts approximately 550 μs.

<sup>9</sup> P<sub>DISS</sub> is calculated from (I<sub>DD</sub> × V<sub>DD</sub>) + (I<sub>SS</sub> × V<sub>SS</sub>) + (I<sub>LOGIC</sub> × V<sub>LOGIC</sub>).

<sup>10</sup> All dynamic characteristics use V<sub>DD</sub> = 15 V, V<sub>SS</sub> = −15 V, and V<sub>LOGIC</sub> = 5 V.

## RESISTOR PERFORMANCE MODE CODE RANGE

Table 2.

| Resistor Tolerance per Code | R <sub>AB</sub> = 20 kΩ                            |                   |  |                   |  |                   |  |                   |
|-----------------------------|--|-------------------|--|-------------------|--|-------------------|--|-------------------|
|                             | V <sub>DD</sub> − V <sub>SS</sub>   = 30 V to 33 V |                   | V <sub>DD</sub> − V <sub>SS</sub>   = 26 V to 30 V |                   | V <sub>DD</sub> − V <sub>SS</sub>   = 22 V to 26 V |                   | V <sub>DD</sub> − V <sub>SS</sub>   = 21 V to 22 V |                   |
|                             | R <sub>WB</sub>                                    | R <sub>WA</sub>   | R <sub>WB</sub>                                    | R <sub>WA</sub>   | R <sub>WB</sub>                                    | R <sub>WA</sub>   | R <sub>WB</sub>                                    | R <sub>WA</sub>   |
| 1% R-Tolerance              | From 0x5A to 0xFF                                  | From 0x00 to 0xA5 | From 0x7D to 0xFF                                  | From 0x00 to 0x82 | From 0x7D to 0xFF                                  | From 0x00 to 0x82 | N/A  | N/A               |
| 2% R-Tolerance              | From 0x23 to 0xFF                                  | From 0x00 to 0xDC | From 0x2D to 0xFF                                  | From 0x00 to 0xD2 | From 0x23 to 0xFF                                  | From 0x00 to 0xDC | From 0x23 to 0xFF                                  | From 0x00 to 0xDC |
| 3% R-Tolerance              | From 0x1E to 0xFF                                  | From 0x00 to 0xE1 | From 0x19 to 0xFF                                  | From 0x00 to 0xE6 | From 0x17 to 0xFF                                  | From 0x00 to 0xE8 | From 0x17 to 0xFF                                  | From 0x00 to 0xE8 |

Table 3.

| Resistor Tolerance per Code | $R_{AB} = 50 \text{ k}\Omega$                       |                   |   |                   | $R_{AB} = 100 \text{ k}\Omega$                      |                   |   |                   |
|-----------------------------|---|-------------------|---|-------------------|---|-------------------|---|-------------------|
|                             | $ V_{DD} - V_{SS}  = 26 \text{ V to } 33 \text{ V}$ |                   | $ V_{DD} - V_{SS}  = 21 \text{ V to } 26 \text{ V}$ |                   | $ V_{DD} - V_{SS}  = 26 \text{ V to } 33 \text{ V}$ |                   | $ V_{DD} - V_{SS}  = 21 \text{ V to } 26 \text{ V}$ |                   |
|                             | $R_{WB}$  | $R_{WA}$          | $R_{WB}$  | $R_{WA}$          | $R_{WB}$  | $R_{WA}$          | $R_{WB}$  | $R_{WA}$          |
| 1% R-Tolerance              | From 0x2A to 0xFF                                   | From 0x00 to 0xD5 | From 0x37 to 0xFF                                   | From 0x00 to 0xC8 | From 0x1E to 0xFF                                   | From 0x00 to 0xE1 | From 0x14 to 0xFF                                   | From 0x00 to 0xEB |
| 2% R-Tolerance              | From 0x11 to 0xFF                                   | From 0x00 to 0xEE | From 0x16 to 0xFF                                   | From 0x00 to 0xE9 | From 0x0A to 0xFF                                   | From 0x00 to 0xF5 | From 0x0A to 0xFF                                   | From 0x00 to 0xF5 |
| 3% R-Tolerance              | From 0x0A to 0xFF                                   | From 0x00 to 0xF5 | From 0x0D to 0xFF                                   | From 0x00 to 0xF2 | From 0x07 to 0xFF                                   | From 0x00 to 0xF8 | From 0x07 to 0xFF                                   | From 0x00 to 0xF8 |

# AD5291/AD5292

## ELECTRICAL CHARACTERISTICS—AD5292

$V_{DD} = 21\text{ V to }33\text{ V}$ ,  $V_{SS} = 0\text{ V}$ ;  $V_{DD} = 10.5\text{ V to }16.5\text{ V}$ ,  $V_{SS} = -10.5\text{ V to }-16.5\text{ V}$ ;  $V_{LOGIC} = 2.7\text{ V to }5.5\text{ V}$ ,  $V_A = V_{DD}$ ,  $V_B = V_{SS}$ ,  $-40^\circ\text{C} < T_A < +105^\circ\text{C}$ , unless otherwise noted.

Table 4.

| Parameter   | Symbol  | Conditions  | Min               | Typ <sup>1</sup>        | Max        | Unit          |
|---|---|---|-------------------|-------------------------|------------|---------------|
| <b>DC CHARACTERISTICS—RHEOSTAT MODE</b>               |   |   |                   |                         |            |               |
| Resolution  | N   |   | 10                |                         |            | Bits          |
| Resistor Differential Nonlinearity <sup>2</sup>       | R-DNL   | $R_{WB}, V_A = \text{NC}$   | -1                |                         | +1         | LSB           |
| Resistor Integral Nonlinearity <sup>2</sup>           | R-INL   | $R_{AB} = 50\text{ k}\Omega, 100\text{ k}\Omega$  | -2                |                         | +2         | LSB           |
|   | R-INL   | $R_{AB} = 20\text{ k}\Omega,  V_{DD} - V_{SS}  = 26\text{ V to }33\text{ V}$  | -2                |                         | +2         | LSB           |
|   | R-INL   | $R_{AB} = 20\text{ k}\Omega,  V_{DD} - V_{SS}  = 21\text{ V to }26\text{ V}$  | -3                |                         | +3         | LSB           |
| Nominal Resistor Tolerance (R-Perf Mode) <sup>3</sup> | $\Delta R_{AB}/R_{AB}$                        | See Table 5 and Table 6   | -1                | $\pm 0.5$               | +1         | %             |
| Nominal Resistor Tolerance (Normal Mode) <sup>4</sup> | $\Delta R_{AB}/R_{AB}$                        |   |                   | $\pm 7$                 |            | %             |
| Resistance Temperature Coefficient                    | $(\Delta R_{AB}/R_{AB})/\Delta T \times 10^6$ | Code = full scale; See Figure 38  |                   | 35                      |            | ppm/°C        |
| Wiper Resistance                                      | $R_W$   | Code = zero scale   |                   | 60                      | 100        | $\Omega$      |
| <b>DC CHARACTERISTICS—POTENTIOMETER DIVIDER MODE</b>  |   |   |                   |                         |            |               |
| Resolution  | N   |   | 10                |                         |            | Bits          |
| Differential Nonlinearity <sup>5</sup>                | DNL   |   | -1                |                         | +1         | LSB           |
| Integral Nonlinearity <sup>5</sup>                    | INL   |   | -1.5              |                         | +1.5       | LSB           |
| Voltage Divider Temperature Coefficient <sup>4</sup>  | $(\Delta V_W/V_W)/\Delta T \times 10^6$       | Code = half scale; See Figure 41  |                   | 5                       |            | ppm/°C        |
| Full-Scale Error                                      | $V_{WFSE}$                                    | Code = full scale   | -8                |                         | +1         | LSB           |
| Zero-Scale Error                                      | $V_{WZSE}$                                    | Code = zero scale   | 0                 |                         | 8          | LSB           |
| <b>RESISTOR TERMINALS</b>                             |   |   |                   |                         |            |               |
| Terminal Voltage Range <sup>4</sup>                   | $V_A, V_B, V_W$                               |   | $V_{SS}$          |                         | $V_{DD}$   | V             |
| Capacitance A, Capacitance B <sup>6</sup>             | $C_A, C_B$                                    | $f = 1\text{ MHz}$ , measured to GND, code = half scale   |                   | 85                      |            | pF            |
| Capacitance W <sup>5</sup>                            | $C_W$   | $f = 1\text{ MHz}$ , measured to GND, code = half scale   |                   | 65                      |            | pF            |
| Common-Mode Leakage Current <sup>4</sup>              | $I_{CM}$                                      | $V_A = V_B = V_W$   |                   | $\pm 1$                 |            | nA            |
| <b>DIGITAL INPUTS</b>                                 |   |   |                   |                         |            |               |
| Input Logic High <sup>4</sup>                         | $V_{IH}$                                      | JEDEC compliant<br>$V_{LOGIC} = 2.7\text{ V to }5.5\text{ V}$   | 2.0               |                         |            | V             |
| Input Logic Low <sup>4</sup>                          | $V_{IL}$                                      | $V_{LOGIC} = 2.7\text{ V to }5.5\text{ V}$  |                   |                         | 0.8        | V             |
| Input Current   | $I_{IL}$                                      | $V_{IN} = 0\text{ V or }V_{LOGIC}$  |                   |                         | $\pm 1$    | $\mu\text{A}$ |
| Input Capacitance <sup>4</sup>                        | $C_{IL}$                                      |   |                   | 5                       |            | pF            |
| <b>DIGITAL OUTPUTS (SDO and RDY)</b>                  |   |   |                   |                         |            |               |
| Output High Voltage <sup>4</sup>                      | $V_{OH}$                                      | $R_{PULL\_UP} = 2.2\text{ k}\Omega\text{ to }V_{LOGIC}$   | $V_{LOGIC} - 0.4$ |                         |            | V             |
| Output Low Voltage <sup>4</sup>                       | $V_{OL}$                                      | $R_{PULL\_UP} = 2.2\text{ k}\Omega\text{ to }V_{LOGIC}$   |                   |                         | GND + 0.4  | V             |
| Three-State Leakage Current                           |   |   | -1                |                         | +1         | $\mu\text{A}$ |
| Output Capacitance <sup>4</sup>                       | $C_{OL}$                                      |   |                   | 5                       |            | pF            |
| <b>POWER SUPPLIES</b>                                 |   |   |                   |                         |            |               |
| Single-Supply Power Range                             | $V_{DD}$                                      | $V_{SS} = 0\text{ V}$   | 9                 |                         | 33         | V             |
| Dual-Supply Power Range                               | $V_{DD}/V_{SS}$                               |   | $\pm 9$           |                         | $\pm 16.5$ | V             |
| Positive Supply Current                               | $I_{DD}$                                      | $V_{DD}/V_{SS} = \pm 16.5\text{ V}$   |                   | 0.1                     | 2          | $\mu\text{A}$ |
| Negative Supply Current                               | $I_{SS}$                                      | $V_{DD}/V_{SS} = \pm 16.5\text{ V}$   | -2                | -0.1                    |            | $\mu\text{A}$ |
| Logic Supply Range                                    | $V_{LOGIC}$                                   |   | 2.7               |                         | 5.5        | V             |
| Logic Supply Current                                  | $I_{LOGIC}$                                   | $V_{LOGIC} = 5\text{ V}$ ; $V_{IH} = 5\text{ V or }V_{IL} = \text{GND}$   |                   | 1                       | 10         | $\mu\text{A}$ |
| OTP Store Current <sup>6, 7</sup>                     | $I_{LOGIC\_PROG}$                             | $V_{IH} = 5\text{ V or }V_{IL} = \text{GND}$  |                   | 25                      |            | mA            |
| OTP Read Current <sup>6, 8</sup>                      | $I_{LOGIC\_FUSE\_READ}$                       | $V_{IH} = 5\text{ V or }V_{IL} = \text{GND}$  |                   | 25                      |            | mA            |
| Power Dissipation <sup>9</sup>                        | $P_{DISS}$                                    | $V_{IH} = 5\text{ V or }V_{IL} = \text{GND}$  |                   | 8                       | 110        | $\mu\text{W}$ |
| Power Supply Rejection Ratio <sup>6</sup>             | PSSR  | $\Delta V_{DD}/\Delta V_{SS} = \pm 15\text{ V} \pm 10\%$<br>$R_{AB} = 20\text{ k}\Omega$<br>$R_{AB} = 50\text{ k}\Omega$<br>$R_{AB} = 100\text{ k}\Omega$ |                   | 0.103<br>0.039<br>0.021 |            | %/%           |

| Parameter                                | Symbol             | Conditions  | Min | Typ <sup>1</sup>                             | Max | Unit                 |
|--|--------------------|---|-----|--|-----|----------------------|
| DYNAMIC CHARACTERISTICS <sup>5, 10</sup> |                    |   |     |  |     |                      |
| Bandwidth                                | BW                 | -3 dB<br>R <sub>AB</sub> = 20 kΩ<br>R <sub>AB</sub> = 50 kΩ<br>R <sub>AB</sub> = 100 kΩ   |     | 520<br>210<br>105                            |     | kHz                  |
| Total Harmonic Distortion                | THD <sub>W</sub>   | V <sub>A</sub> = 1 V rms, V <sub>B</sub> = 0 V, f = 1 kHz<br>R <sub>AB</sub> = 20 kΩ<br>R <sub>AB</sub> = 50 kΩ<br>R <sub>AB</sub> = 100 kΩ   |     | -93<br>-101<br>-106                          |     | dB                   |
| V <sub>w</sub> Settling Time             | t <sub>s</sub>     | V <sub>A</sub> = 30 V, V <sub>B</sub> = 0 V, ±0.5 LSB error band, initial code = zero scale, board capacitance = 170 pF<br>Code = full-scale, normal mode<br>Code = full-scale, R-Perf mode<br>Code = half-scale, normal mode<br>R <sub>AB</sub> = 20 kΩ<br>R <sub>AB</sub> = 50 kΩ<br>R <sub>AB</sub> = 100 kΩ<br>Code = half-scale, R-Perf mode<br>R <sub>AB</sub> = 20 kΩ<br>R <sub>AB</sub> = 50 kΩ<br>R <sub>AB</sub> = 100 kΩ |     | 750<br>2.5<br>2.5<br>7<br>14<br>5<br>9<br>16 |     | ns<br>μs<br>μs<br>μs |
| Resistor Noise Density                   | e <sub>N, WB</sub> | Code = half-scale, T <sub>A</sub> = 25°C, 0 kHz to 200 kHz<br>R <sub>AB</sub> = 20 kΩ<br>R <sub>AB</sub> = 50 kΩ<br>R <sub>AB</sub> = 100 kΩ  |     | 10<br>18<br>27                               |     | nV/√Hz               |

<sup>1</sup> Typical values represent average readings at 25°C, V<sub>DD</sub> = 15 V, V<sub>SS</sub> = -15 V, and V<sub>LOGIC</sub> = 5 V.

<sup>2</sup> Resistor position nonlinearity error. R-INL is the deviation from an ideal value measured between the R<sub>WB</sub> at code 0x00B to code 0x3FF or between R<sub>WA</sub> at code 0x3F3 to code 0x000. R-DNL measures the relative step change from ideal between successive tap positions. The specification is guaranteed in resistor performance mode, with a wiper current of 1 mA for V<sub>A</sub> < 12 V and 1.2 mA for V<sub>A</sub> ≥ 12 V.

<sup>3</sup> Resistor performance mode (see the Resistor Performance Mode section). The terms resistor performance mode and R-Perf mode are used interchangeably.

<sup>4</sup> Guaranteed by design and characterization, not subject to production test.

<sup>5</sup> INL and DNL are measured at V<sub>w</sub> with the RDAC configured as a potentiometer divider similar to a voltage output DAC. V<sub>A</sub> = V<sub>DD</sub> and V<sub>B</sub> = 0 V. DNL specification limits of ±1 LSB maximum are guaranteed monotonic operating conditions.

<sup>6</sup> Resistor Terminal A, Resistor Terminal B, and Resistor Terminal W have no limitations on polarity with respect to each other. Dual-supply operation enables ground-referenced bipolar signal adjustment.

<sup>7</sup> Different from operating current; supply current for fuse program lasts approximately 550 μs.

<sup>8</sup> Different from operating current; supply current for fuse read lasts approximately 550 μs.

<sup>9</sup> P<sub>DISS</sub> is calculated from (I<sub>DD</sub> × V<sub>DD</sub>) + (I<sub>SS</sub> × V<sub>SS</sub>) + (I<sub>LOGIC</sub> × V<sub>LOGIC</sub>).

<sup>10</sup> All dynamic characteristics use V<sub>DD</sub> = 15 V, V<sub>SS</sub> = -15 V, and V<sub>LOGIC</sub> = 5 V.

## RESISTOR PERFORMANCE MODE CODE RANGE

Table 5.

| Resistor Tolerance per Code | R <sub>AB</sub> = 20 kΩ                            |                     |  |                     |  |                     |  |                     |
|-----------------------------|--|---------------------|--|---------------------|--|---------------------|--|---------------------|
|                             | V <sub>DD</sub> - V <sub>SS</sub>   = 30 V to 33 V |                     | V <sub>DD</sub> - V <sub>SS</sub>   = 26 V to 30 V |                     | V <sub>DD</sub> - V <sub>SS</sub>   = 22 V to 26 V |                     | V <sub>DD</sub> - V <sub>SS</sub>   = 21 V to 22 V |                     |
|                             | R <sub>WB</sub>                                    | R <sub>WA</sub>     | R <sub>WB</sub>                                    | R <sub>WA</sub>     | R <sub>WB</sub>                                    | R <sub>WA</sub>     | R <sub>WB</sub>                                    | R <sub>WA</sub>     |
| 1% R-Tolerance              | From 0x15E to 0x3FF                                | From 0x000 to 0x2A1 | From 0x1F4 to 0x3FF                                | From 0x000 to 0x20B | From 0x1F4 to 0x3FF                                | From 0x000 to 0x20B | N/A  | N/A                 |
| 2% R-Tolerance              | From 0x8C to 0x3FF                                 | From 0x000 to 0x373 | From 0xB4 to 0x3FF                                 | From 0x000 to 0x34B | From 0xFA to 0x3FF                                 | From 0x000 to 0x305 | From 0xFA to 0x3FF                                 | From 0x000 to 0x305 |
| 3% R-Tolerance              | From 0x5A to 0x3FF                                 | From 0x000 to 0x3A5 | From 0x64 to 0x3FF                                 | From 0x000 to 0x39B | From 0x78 to 0x3FF                                 | From 0x000 to 0x387 | From 0x78 to 0x3FF                                 | From 0x000 to 0x387 |

# AD5291/AD5292

Table 6.

| Resistor Tolerance per Code | $R_{AB} = 50\text{ k}\Omega$                     |                     |  |                     | $R_{AB} = 100\text{ k}\Omega$                    |                     |  |                     |
|-----------------------------|--|---------------------|--|---------------------|--|---------------------|--|---------------------|
|                             | $ V_{DD} - V_{SS}  = 26\text{ V to }33\text{ V}$ |                     | $ V_{DD} - V_{SS}  = 21\text{ V to }26\text{ V}$ |                     | $ V_{DD} - V_{SS}  = 26\text{ V to }33\text{ V}$ |                     | $ V_{DD} - V_{SS}  = 21\text{ V to }26\text{ V}$ |                     |
|                             | R <sub>WB</sub>                                  | R <sub>WA</sub>     | R <sub>WB</sub>                                  | R <sub>WA</sub>     | R <sub>WB</sub>                                  | R <sub>WA</sub>     | R <sub>WB</sub>                                  | R <sub>WA</sub>     |
| 1% R-Tolerance              | From 0x08C to 0x3FF                              | From 0x000 to 0x35F | From 0x0B4 to 0x3FF                              | From 0x000 to 0x31E | From 0x04B to 0x3FF                              | From 0x000 to 0x3B4 | From 0x064 to 0x3FF                              | From 0x000 to 0x39B |
| 2% R-Tolerance              | From 0x03C to 0x3FF                              | From 0x000 to 0x3C3 | From 0x050 to 0x3FF                              | From 0x000 to 0x3AF | From 0x028 to 0x3FF                              | From 0x000 to 0x3D7 | From 0x028 to 0x3FF                              | From 0x000 to 0x3D7 |
| 3% R-Tolerance              | From 0x028 to 0x3FF                              | From 0x000 to 0x3D7 | From 0x032 to 0x3FF                              | From 0x000 to 0x3CD | From 0x019 to 0x3FF                              | From 0x000 to 0x3E6 | From 0x019 to 0x3FF                              | From 0x000 to 0x3E6 |

## INTERFACE TIMING SPECIFICATIONS

$V_{DD}/V_{SS} = \pm 15\text{ V}$ ,  $V_{LOGIC} = 2.7\text{ V to }5.5\text{ V}$ ,  $-40^\circ\text{C} < T_A < +105^\circ\text{C}$ . All specifications  $T_{MIN}$  to  $T_{MAX}$ , unless otherwise noted.

Table 7.

| Parameter               | Limit <sup>1</sup> | Unit              | Description  |
|-------------------------|--------------------|-------------------|--|
| $t_1^2$                 | 20                 | ns min            | SCLK cycle time  |
| $t_2$                   | 10                 | ns min            | SCLK high time   |
| $t_3$                   | 10                 | ns min            | SCLK low time  |
| $t_4$                   | 10                 | ns min            | $\overline{\text{SYNC}}$ to SCLK falling edge setup time             |
| $t_5$                   | 5                  | ns min            | Data setup time  |
| $t_6$                   | 5                  | ns min            | Data hold time   |
| $t_7$                   | 1                  | ns min            | SCLK falling edge to $\overline{\text{SYNC}}$ rising edge            |
| $t_8$                   | 400 <sup>3</sup>   | ns min            | Minimum $\overline{\text{SYNC}}$ high time                           |
| $t_9$                   | 14                 | ns min            | $\overline{\text{SYNC}}$ rising edge to next SCLK fall ignore        |
| $t_{10}^4$              | 1                  | ns min            | RDY rising edge to $\overline{\text{SYNC}}$ falling edge             |
| $t_{11}^4$              | 40                 | ns max            | $\overline{\text{SYNC}}$ rising edge to RDY fall time                |
| $t_{12}^4$              | 2.4                | $\mu\text{s max}$ | RDY low time, RDAC register write command execute time (R-Perf mode) |
| $t_{12}^4$              | 410                | ns max            | RDY low time, RDAC register write command execute time (normal mode) |
| $t_{12}^4$              | 8                  | ms max            | RDY low time, memory program execute time                            |
| $t_{12}^4$              | 1.5                | ms min            | Software/hardware reset  |
| $t_{13}^4$              | 450                | ns max            | RDY low time, RDAC register readback execute time                    |
| $t_{13}^4$              | 1.3                | ms max            | RDY low time, memory readback execute time                           |
| $t_{14}^4$              | 450                | ns max            | SCLK rising edge to SDO valid  |
| $t_{\text{RESET}}$      | 20                 | ns min            | Minimum $\overline{\text{RESET}}$ pulse width (asynchronous)         |
| $t_{\text{POWER-UP}}^5$ | 2                  | ms max            | Power-on OTP restore time  |

<sup>1</sup> All input signals are specified with  $t_r = t_f = 1\text{ ns/V}$  (10% to 90% of  $V_{DD}$ ) and timed from a voltage level of  $(V_{IL} + V_{IH})/2$ .

<sup>2</sup> Maximum SCLK frequency is 50 MHz.

<sup>3</sup> Refer to  $t_{12}$  and  $t_{13}$  for RDAC register and memory commands operations.

<sup>4</sup>  $R_{\text{PULL-UP}} = 2.2\text{ k}\Omega$  to  $V_{\text{LOGIC}}$ , with a capacitance load of 168 pF.

<sup>5</sup> Maximum time after  $V_{\text{LOGIC}}$  is equal to 2.5 V.

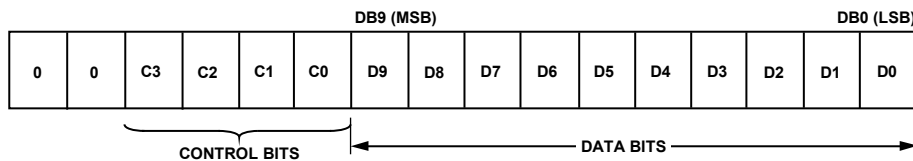

Figure 2. Shift Register Content



Timing Diagrams

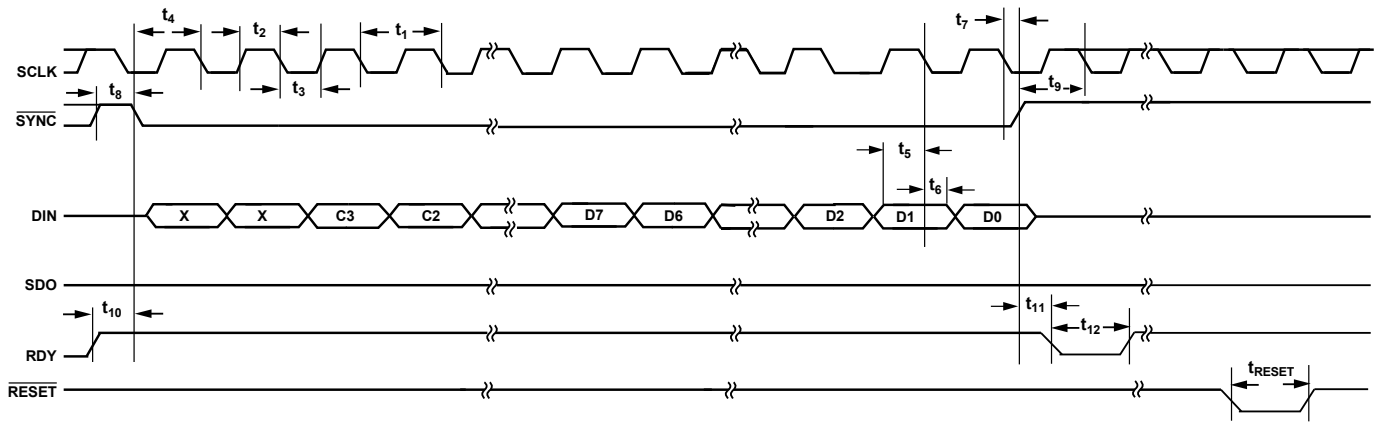

Figure 3. Write Timing Diagram, CPOL = 0, CPHA = 1

07674-004

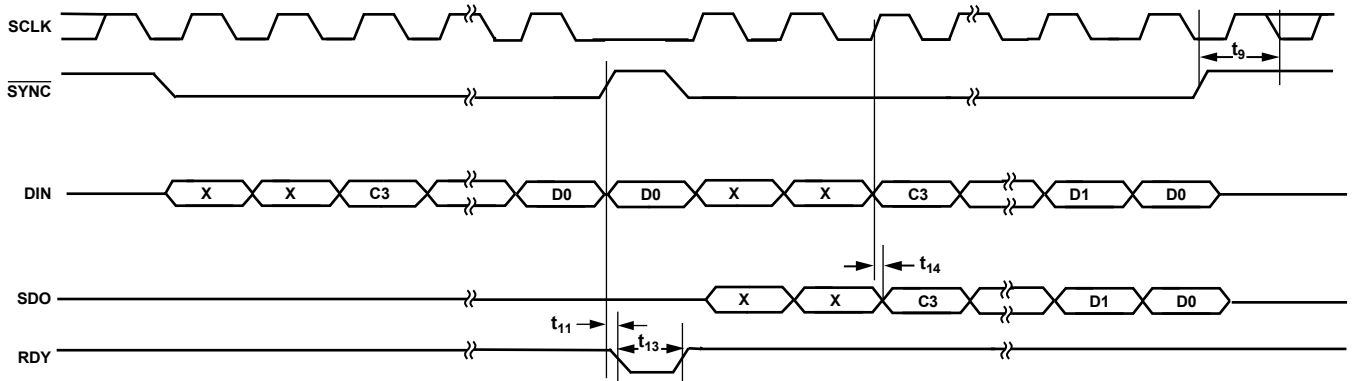

Figure 4. Read Timing Diagram, CPOL = 0, CPHA = 1

07674-005

## ABSOLUTE MAXIMUM RATINGS

T<sub>A</sub> = 25°C, unless otherwise noted.

**Table 8.**

| Parameter   | Rating   |
|---|--|
| V <sub>DD</sub> to GND                                  | −0.3 V to +35 V  |
| V <sub>SS</sub> to GND                                  | +0.3 V to −25 V  |
| V <sub>LOGIC</sub> to GND                               | −0.3 V to +7 V   |
| V <sub>DD</sub> to V <sub>SS</sub>                      | 35 V   |
| V <sub>A</sub> , V <sub>B</sub> , V <sub>W</sub> to GND | V <sub>SS</sub> − 0.3 V, V <sub>DD</sub> + 0.3 V       |
| Digital Input and Output Voltage to GND                 | −0.3 V to V <sub>LOGIC</sub> + 0.3 V                   |
| EXT_CAP Voltage to GND                                  | −0.3 V to +7 V   |
| I <sub>A</sub> , I <sub>B</sub> , I <sub>W</sub>        |  |
| Continuous  |  |
| R <sub>AB</sub> = 20 kΩ                                 | ±3 mA  |
| R <sub>AB</sub> = 50 kΩ, 100 kΩ                         | ±2 mA  |
| Pulsed <sup>1</sup>                                     |  |
| Frequency > 10 kHz                                      | MCC <sup>2</sup> /d <sup>3</sup>                       |
| Frequency ≤ 10 kHz                                      | MCC <sup>2</sup> /√d <sup>3</sup>                      |
| Operating Temperature Range <sup>4</sup>                | −40°C to +105°C  |
| Maximum Junction Temperature (T <sub>J</sub> max)       | 150°C  |
| Storage Temperature Range                               | −65°C to +150°C  |
| Reflow Soldering  |  |
| Peak Temperature  | 260°C  |
| Time at Peak Temperature                                | 20 sec to 40 sec                                       |
| Package Power Dissipation                               | (T <sub>J</sub> max − T <sub>A</sub> )/θ <sub>JA</sub> |

<sup>1</sup> Maximum terminal current is bounded by the maximum current handling of the switches, maximum power dissipation of the package, and maximum applied voltage across any two of the A, B, and W terminals at a given resistance.

<sup>2</sup> Maximum continuous current

<sup>3</sup> Pulse duty factor.

<sup>4</sup> Includes programming of OTP memory.

Stresses above those listed under Absolute Maximum Ratings may cause permanent damage to the device. This is a stress rating only; functional operation of the device at these or any other conditions above those indicated in the operational section of this specification is not implied. Exposure to absolute maximum rating conditions for extended periods may affect device reliability.

### THERMAL RESISTANCE

θ<sub>JA</sub> is defined by JEDEC specification JESD-51 and the value is dependent on the test board and test environment.

**Table 9. Thermal Resistance**

| Package Type  | θ <sub>JA</sub> | θ <sub>JC</sub> | Unit |
|---------------|-----------------|-----------------|------|
| 14-Lead TSSOP | 93 <sup>1</sup> | 20              | °C/W |

<sup>1</sup> JEDEC 252P test board, still air (0 m/sec to 1 m/sec air flow).

### ESD CAUTION



**ESD (electrostatic discharge) sensitive device.** Charged devices and circuit boards can discharge without detection. Although this product features patented or proprietary protection circuitry, damage may occur on devices subjected to high energy ESD. Therefore, proper ESD precautions should be taken to avoid performance degradation or loss of functionality.

## PIN CONFIGURATION AND FUNCTION DESCRIPTIONS

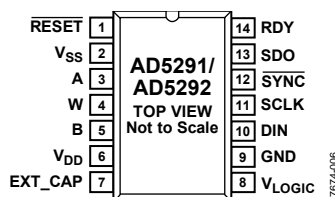

Figure 5. Pin Configuration

Table 10. Pin Function Descriptions

| Pin No. | Mnemonic           | Description   |
|---------|--------------------|---|
| 1       | RESET              | Hardware Reset Pin. Refreshes the RDAC register with the contents of the 20-TP memory register. Factory default loads midscale until the first 20-TP wiper memory location is programmed. RESET is activated at the logic high transition. Tie RESET to V <sub>LOGIC</sub> if not used.   |
| 2       | V <sub>SS</sub>    | Negative Supply. Connect to 0 V for single-supply applications. This pin should be decoupled with 0.1 μF ceramic capacitors and 10 μF capacitors.   |
| 3       | A                  | Terminal A of RDAC. $V_{SS} \leq V_A \leq V_{DD}$ .   |
| 4       | W                  | Wiper Terminal of RDAC. $V_{SS} \leq V_W \leq V_{DD}$ .   |
| 5       | B                  | Terminal B of RDAC. $V_{SS} \leq V_B \leq V_{DD}$ .   |
| 6       | V <sub>DD</sub>    | Positive Power Supply. This pin should be decoupled with 0.1 μF ceramic capacitors and 10 μF capacitors.  |
| 7       | EXT_CAP            | External Capacitor. Connect a 1 μF capacitor to EXT_CAP. This capacitor must have a voltage rating of ≥7 V.   |
| 8       | V <sub>LOGIC</sub> | Logic Power Supply; 2.7 V to 5.5 V. This pin should be decoupled with 0.1 μF ceramic capacitors and 10 μF capacitors.   |
| 9       | GND                | Ground Pin, Logic Ground Reference.   |
| 10      | DIN                | Serial Data Input. The AD5291 and AD5292 have a 16-bit shift register. Data is clocked into the register on the falling edge of the serial clock input.   |
| 11      | SCLK               | Serial Clock Input. Data is clocked into the shift register on the falling edge of the serial clock input. Data can be transferred at rates up to 50 MHz.   |
| 12      | SYNC               | Falling Edge Synchronization Signal. This is the frame synchronization signal for the input data. When SYNC goes low, it enables the shift register and data is transferred in on the falling edges of the following clocks. The selected register is updated on the rising edge of SYNC following the 16 <sup>th</sup> clock cycle. If SYNC is taken high before the 16 <sup>th</sup> clock cycle, the rising edge of SYNC acts as an interrupt, and the write sequence is ignored by the DAC. |
| 13      | SDO                | Serial Data Output. This open-drain output requires an external pull-up resistor. SDO can be used to clock data from the shift register in daisy-chain mode or in readback mode.  |
| 14      | RDY                | Ready Pin. This active-high open-drain output identifies the completion of a write or read operation to or from the RDAC register or memory.  |

## TYPICAL PERFORMANCE CHARACTERISTICS

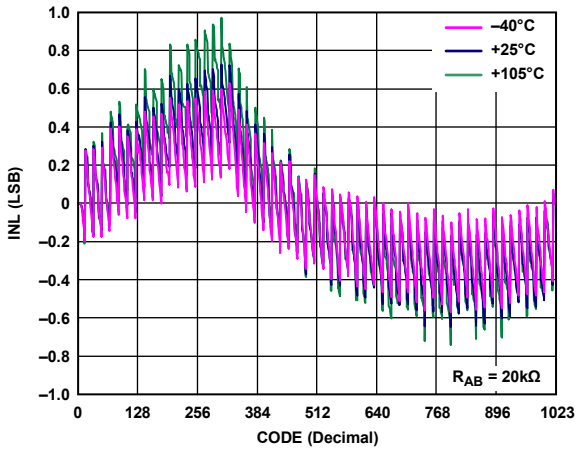

Figure 6. R-INL in R-Perf Mode vs. Code vs. Temperature (AD5292)

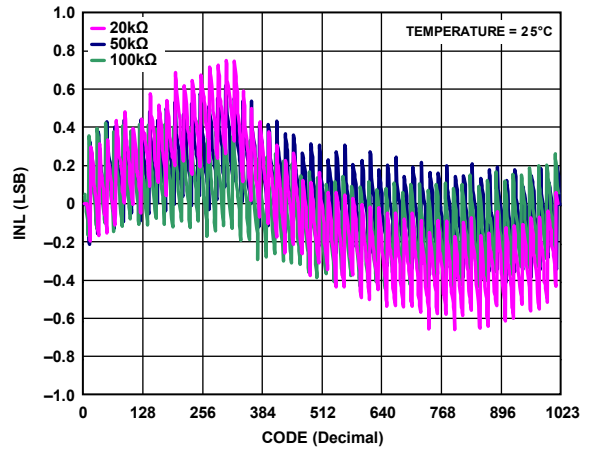

Figure 9. R-INL in R-Perf Mode vs. Code vs. Nominal Resistance (AD5292)

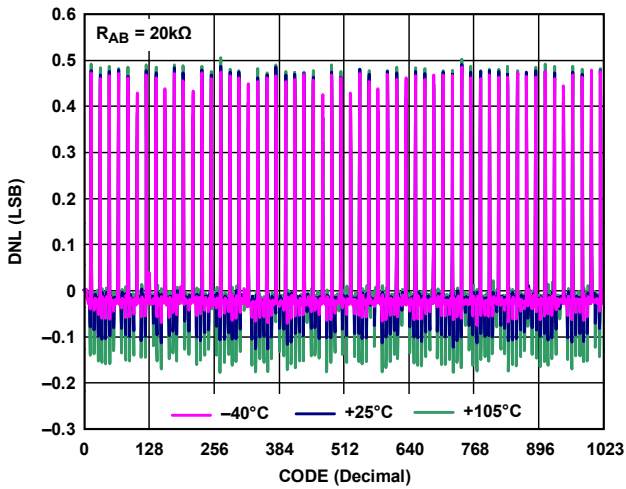

Figure 7. R-DNL in R-Perf Mode vs. Code vs. Temperature (AD5292)

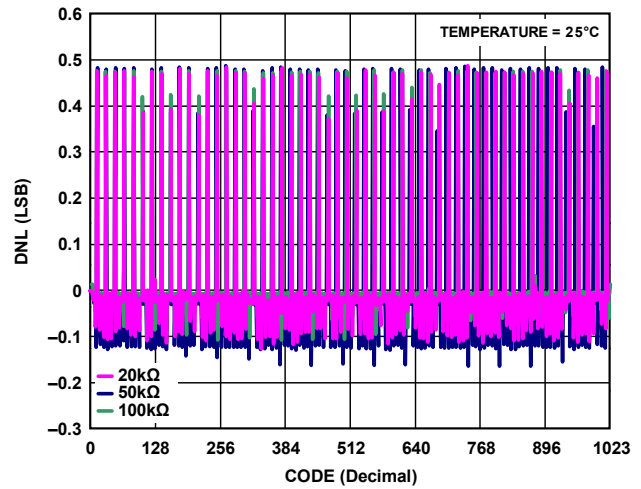

Figure 10. R-DNL in R-Perf Mode vs. Code vs. Nominal Resistance (AD5292)

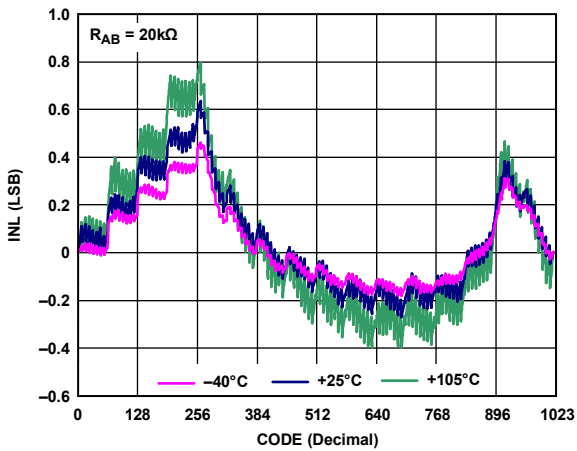

Figure 8. R-INL in Normal Mode vs. Code vs. Temperature (AD5292)

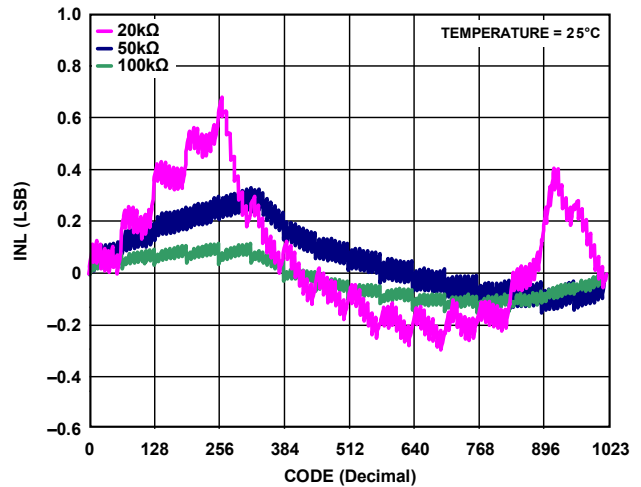

Figure 11. R-INL in Normal Mode vs. Code vs. Nominal Resistance (AD5292)

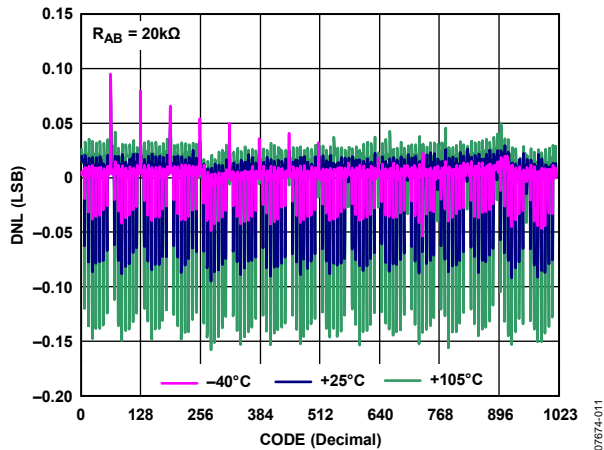

Figure 12. R-DNL in Normal Mode vs. Code vs. Temperature (AD5292)

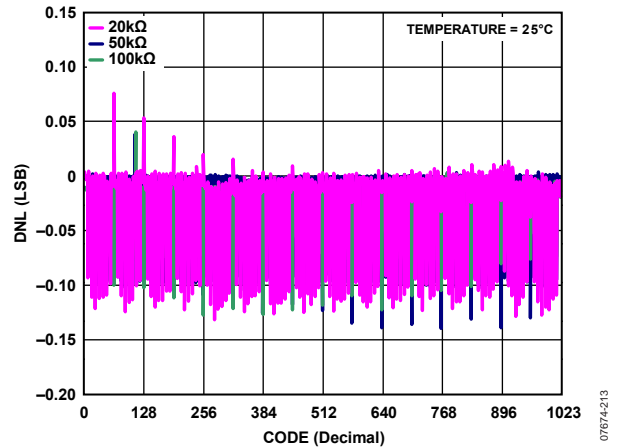

Figure 15. R-DNL in Normal Mode vs. Code vs. Nominal Resistance (AD5292)

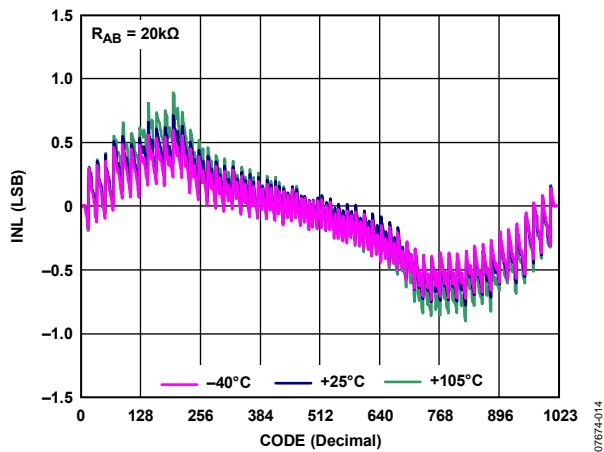

Figure 13. INL in R-Perf Mode vs. Code vs. Temperature (AD5292)

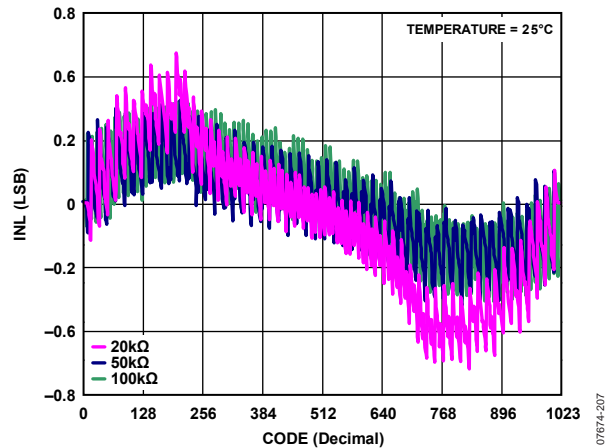

Figure 16. INL in R-Perf Mode vs. Code vs. Nominal Resistance (AD5292)

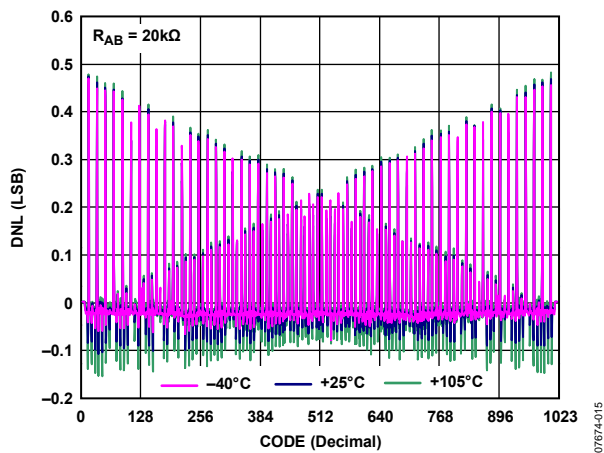

Figure 14. DNL in R-Perf Mode vs. Code vs. Temperature (AD5292)

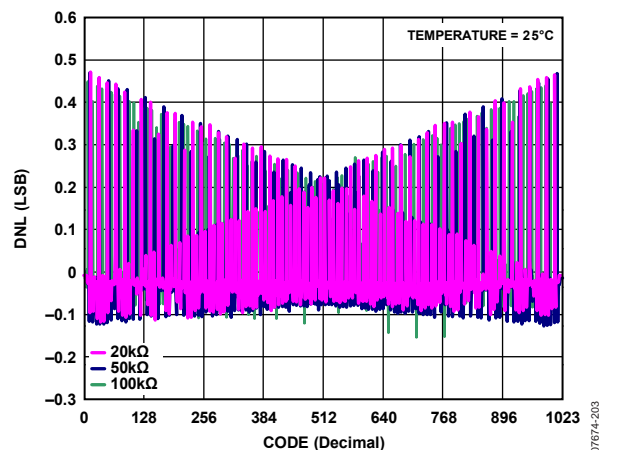

Figure 17. DNL in R-Perf Mode vs. Code vs. Nominal Resistance (AD5292)

# AD5291/AD5292

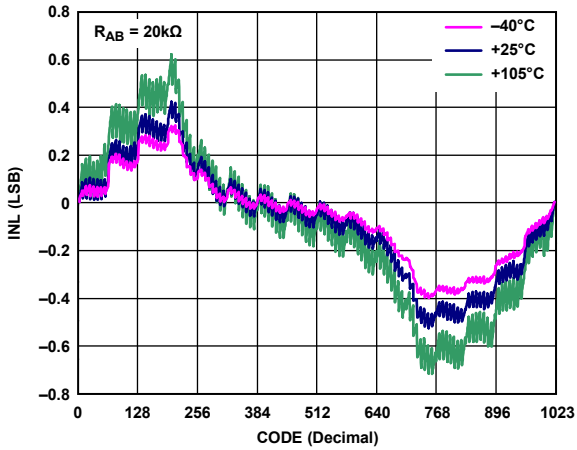

Figure 18. INL in Normal Mode vs. Code vs. Temperature (AD5292)

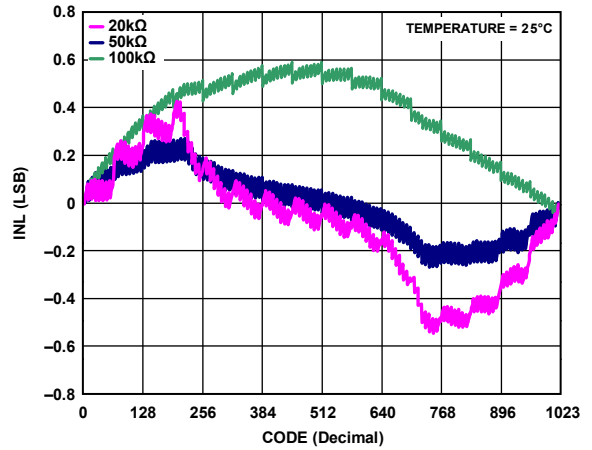

Figure 21. INL in Normal Mode vs. Code vs. Nominal Resistance (AD5292)

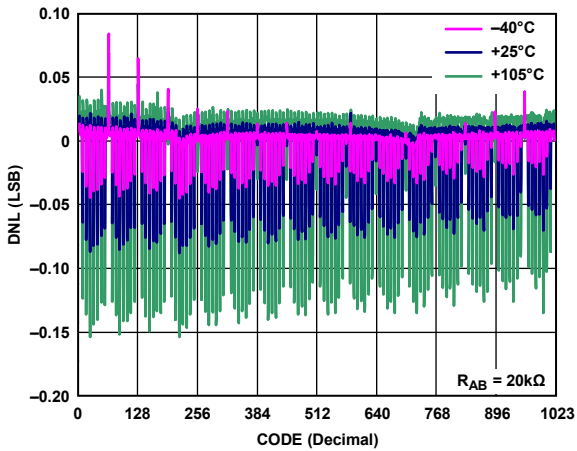

Figure 19. DNL in Normal Mode vs. Code vs. Temperature (AD5292)

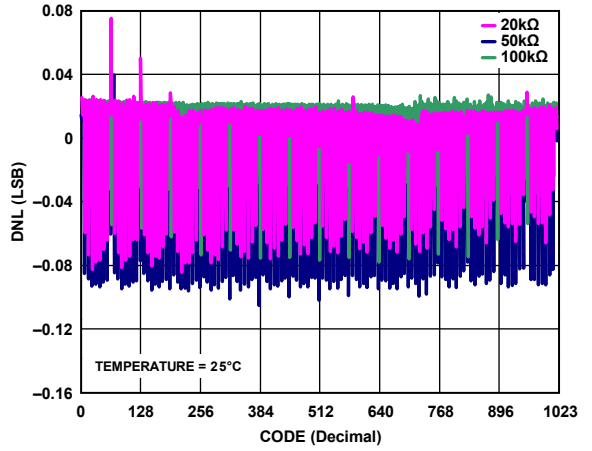

Figure 22. DNL in Normal Mode vs. Code vs. Nominal Resistance (AD5292)

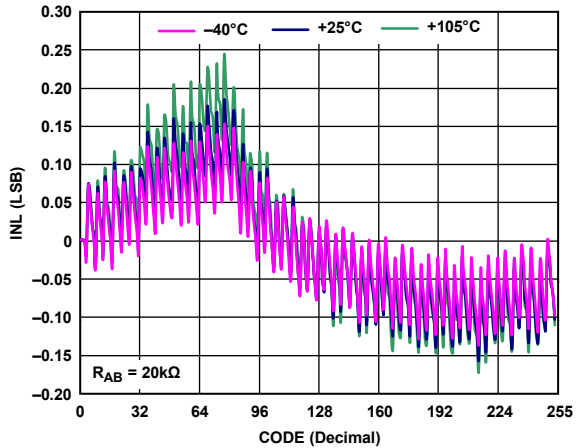

Figure 20. R-INL in R-Perf Mode vs. Code vs. Temperature (AD5292)

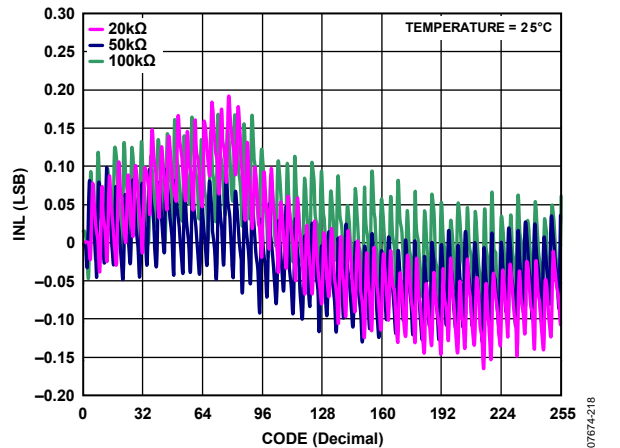

Figure 23. R-INL in R-Perf Mode vs. Code vs. Nominal Resistance (AD5292)

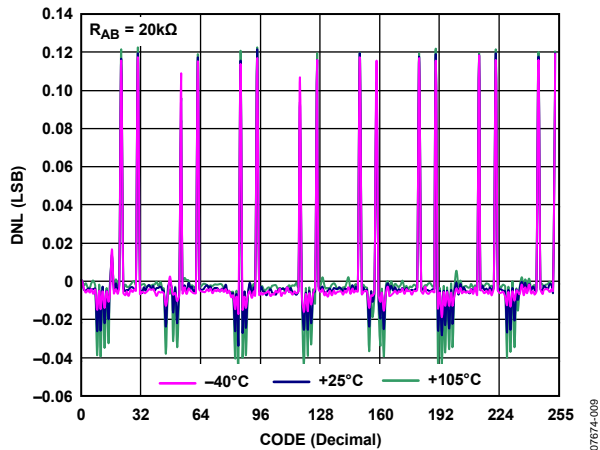

Figure 24. R-DNL in R-Perf Mode vs. Code vs. Temperature (AD5291)

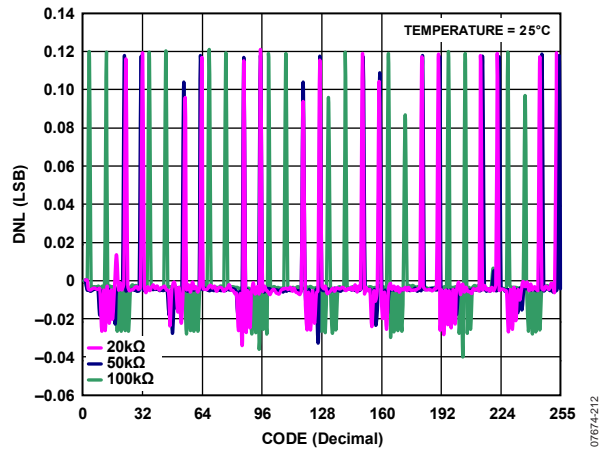

Figure 27. R-DNL in R-Perf Mode vs. Code vs. Nominal Resistance (AD5291)

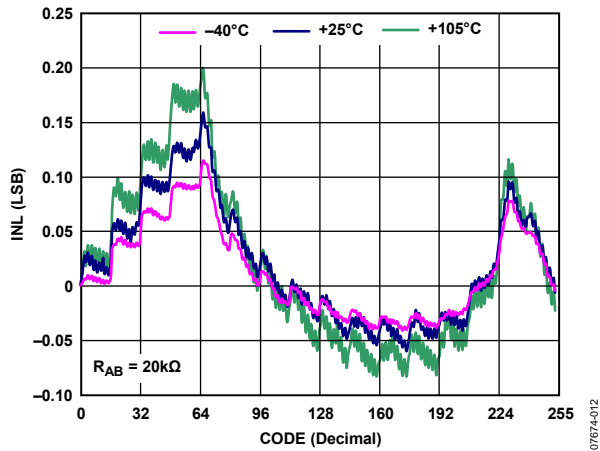

Figure 25. R-INL in Normal Mode vs. Code vs. Temperature (AD5291)

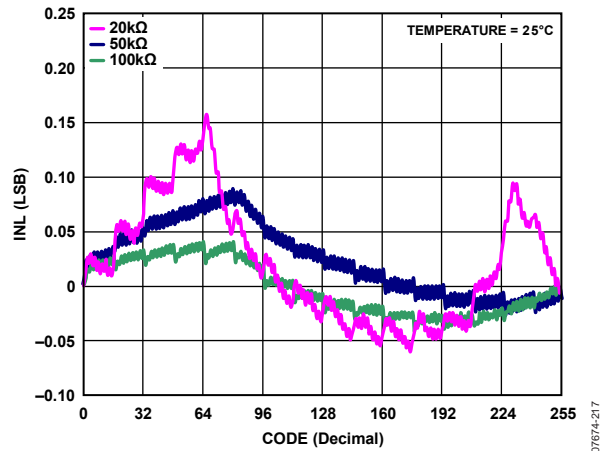

Figure 28. R-INL in Normal Mode vs. Code vs. Nominal Resistance (AD5291)

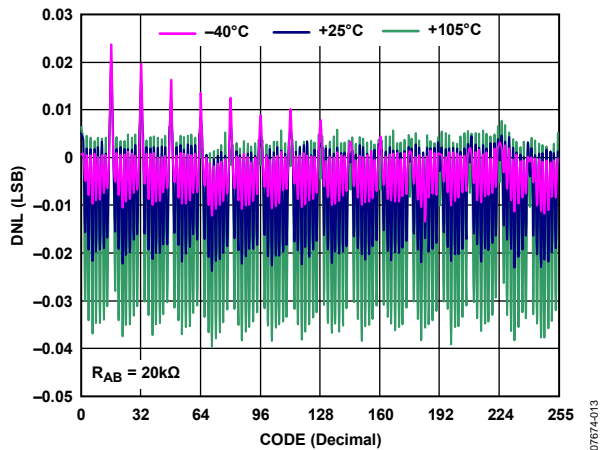

Figure 26. R-DNL in Normal Mode vs. Code vs. Temperature (AD5291)

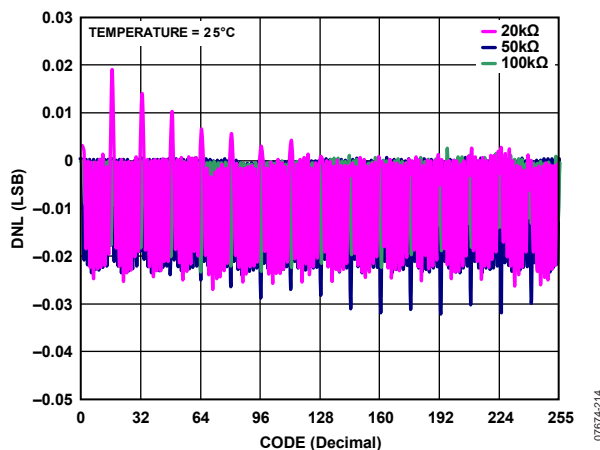

Figure 29. R-DNL in Normal Mode vs. Code vs. Nominal Resistance (AD5291)

# AD5291/AD5292

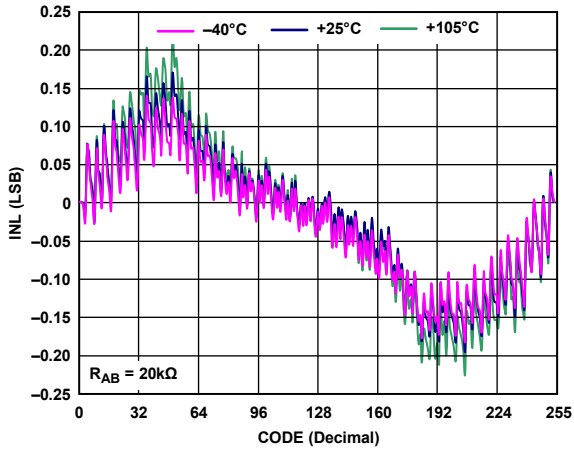

Figure 30. INL in R-Perf Mode vs. Code vs. Temperature (AD5291)

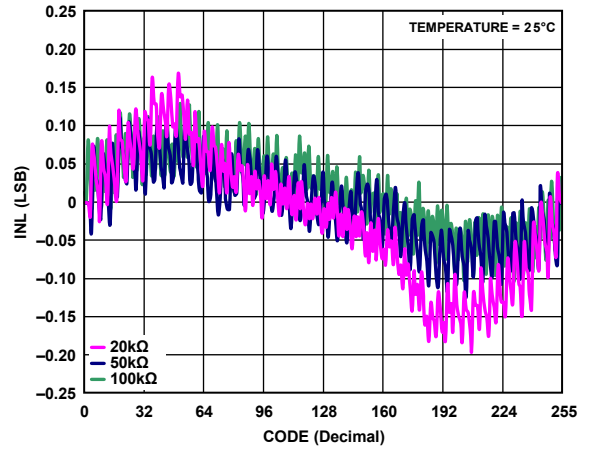

Figure 33. INL in R-Perf Mode vs. Code vs. Nominal Resistance (AD5291)

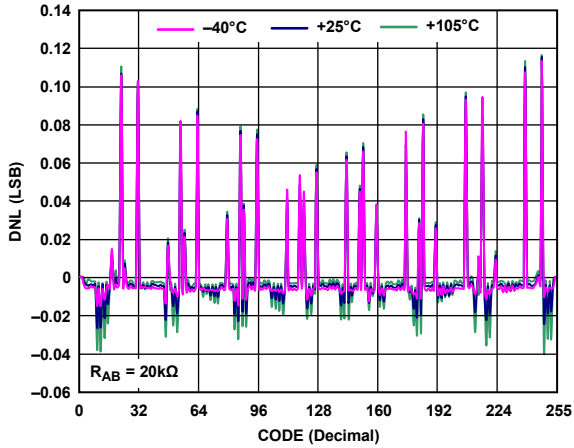

Figure 31. DNL in R-Perf Mode vs. Code vs. Temperature (AD5291)

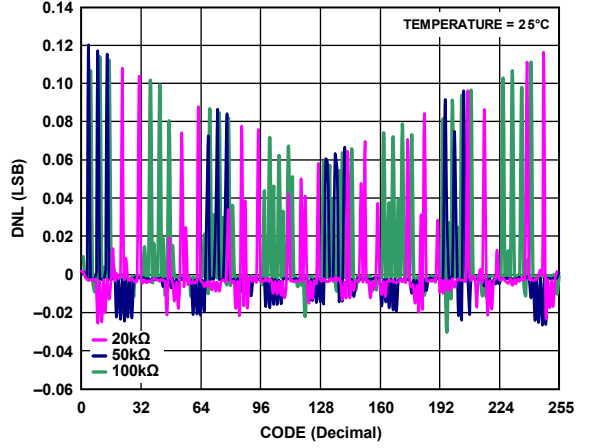

Figure 34. DNL in R-Perf Mode vs. Code vs. Nominal Resistance (AD5291)

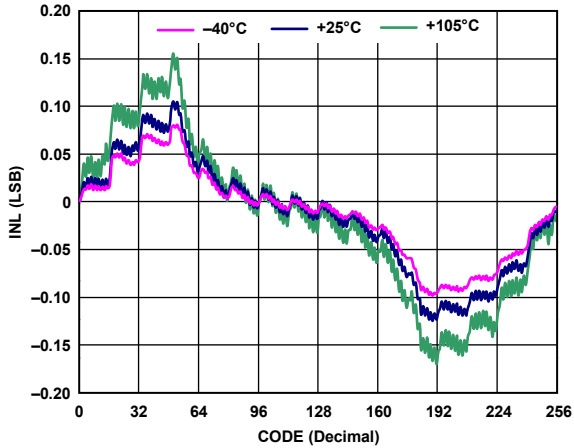

Figure 32. INL in Normal Mode vs. Code vs. Temperature (AD5291)

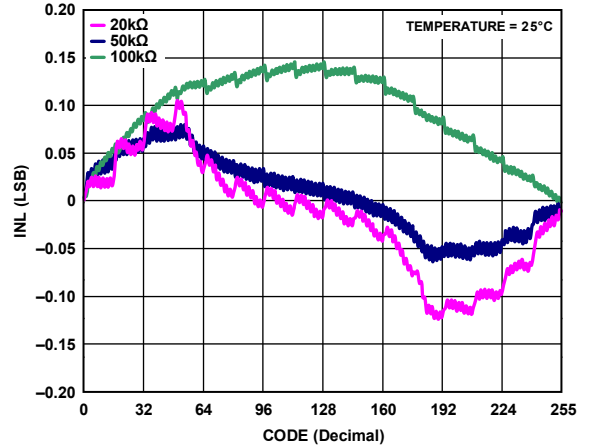

Figure 35. INL in Normal Mode vs. Code vs. Nominal Resistance (AD5291)



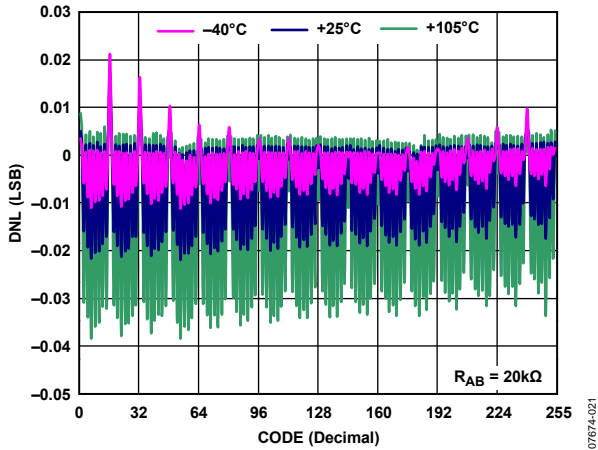

Figure 36. DNL in Normal Mode vs. Code vs. Temperature (AD5291)

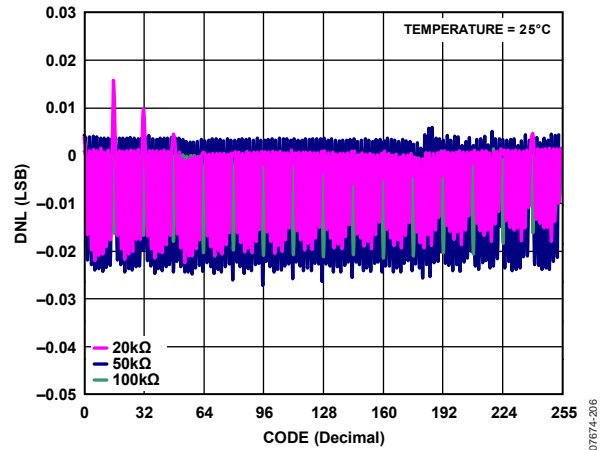

Figure 39. DNL in Normal Mode vs. Code vs. Temperature (AD5291)

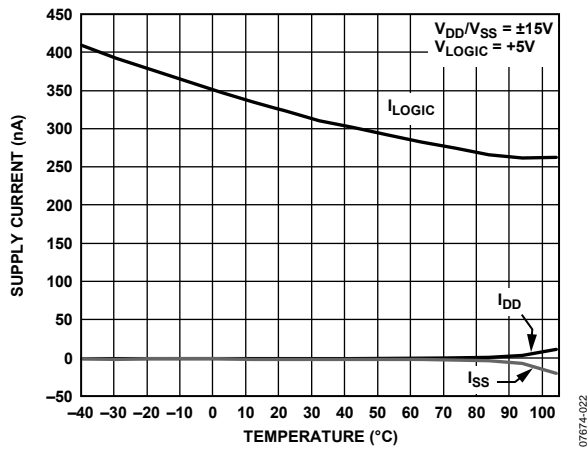

Figure 37. Supply Current ( $I_{DD}$ ,  $I_{SS}$ ,  $I_{LOGIC}$ ) vs. Temperature

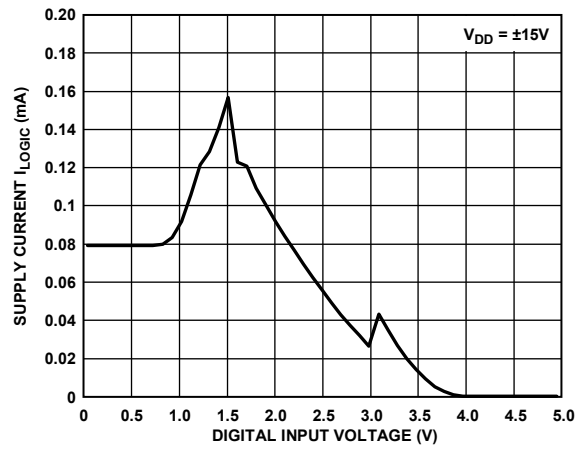

Figure 40. Supply Current  $I_{LOGIC}$  vs. Digital Input Voltage

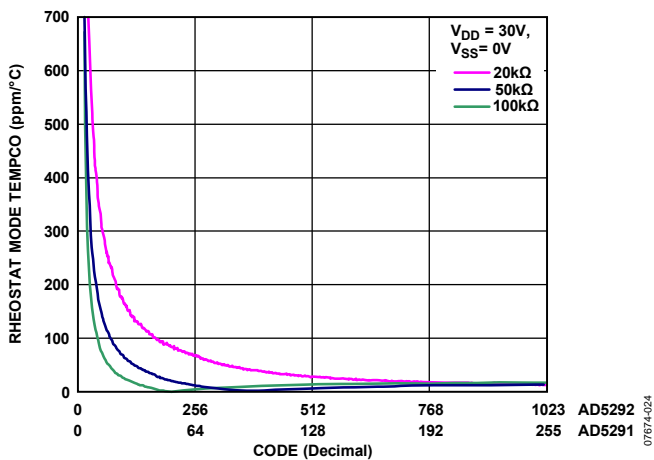

Figure 38. Rheostat Mode Tempco  $\Delta R_{WB}/\Delta T$  vs. Code

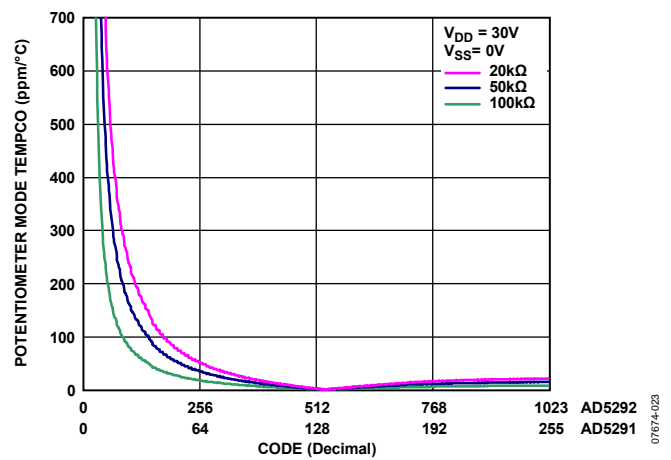

Figure 41. Potentiometer Mode Tempco  $\Delta R_{WB}/\Delta T$  vs. Code

# AD5291/AD5292

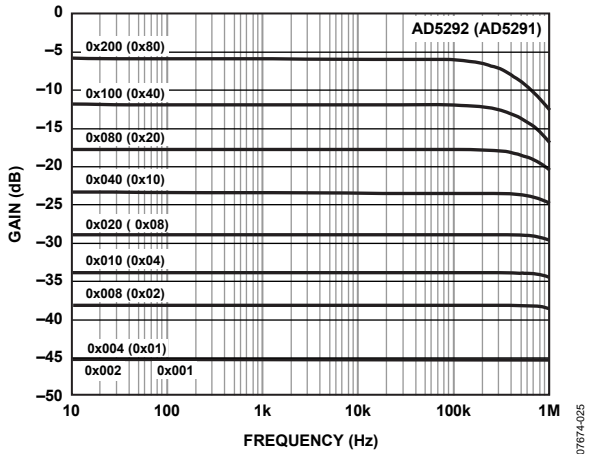

Figure 42. 20 kΩ Gain vs. Frequency vs. Code

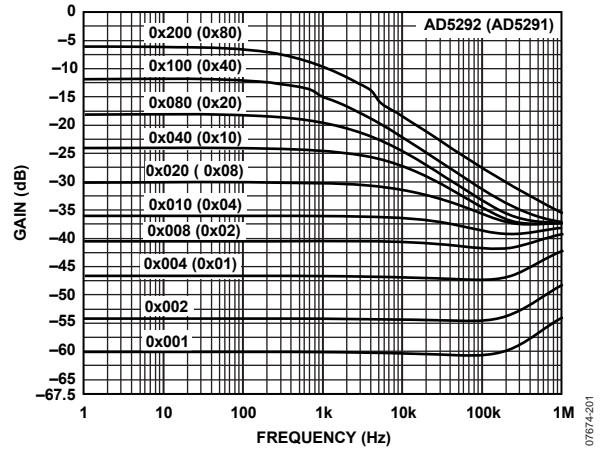

Figure 45. 100 kΩ Gain vs. Frequency vs. Code

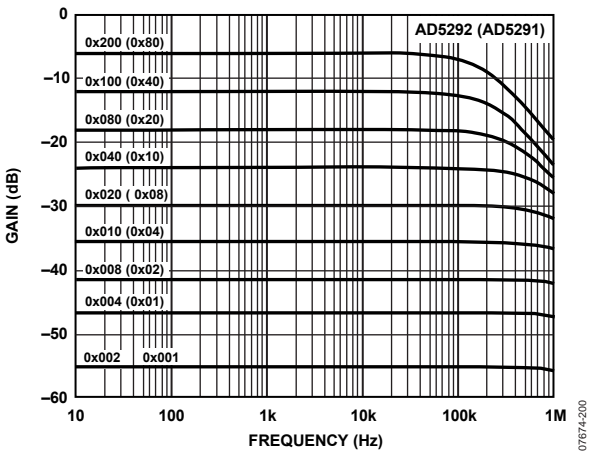

Figure 43. 50 kΩ Gain vs. Frequency vs. Code

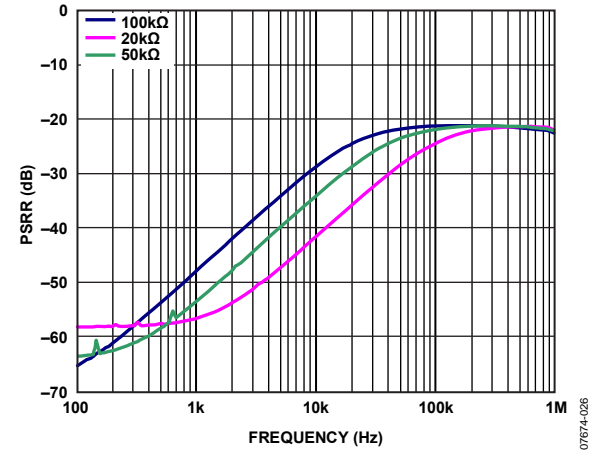

Figure 46. Power Supply Rejection Ratio vs. Frequency

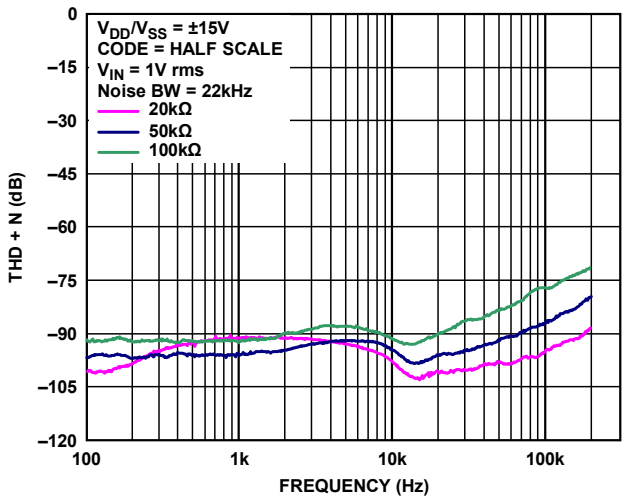

Figure 44. THD + Noise vs. Frequency

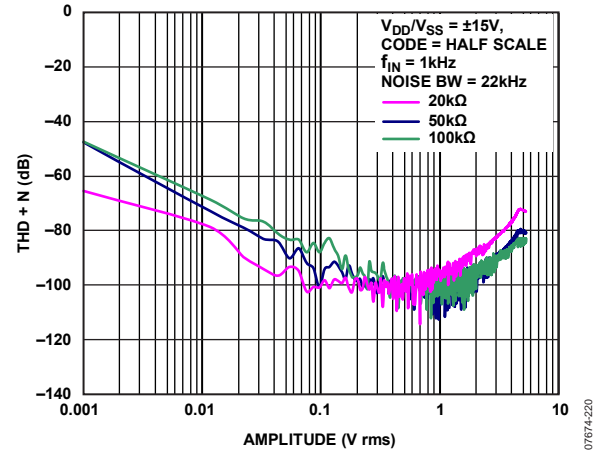

Figure 47. THD + Noise vs. Amplitude

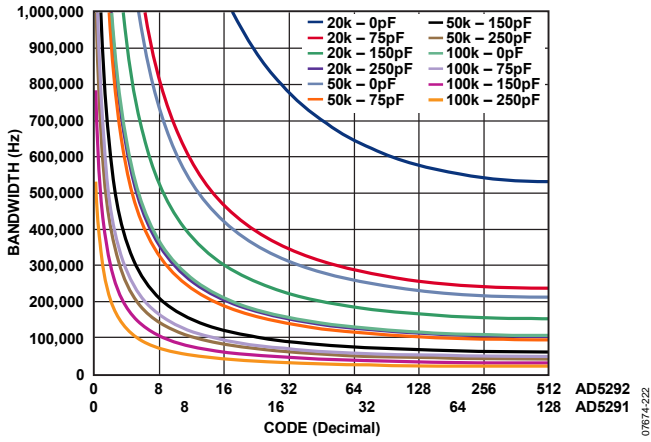

Figure 48. Bandwidth vs Code vs Net Capacitance

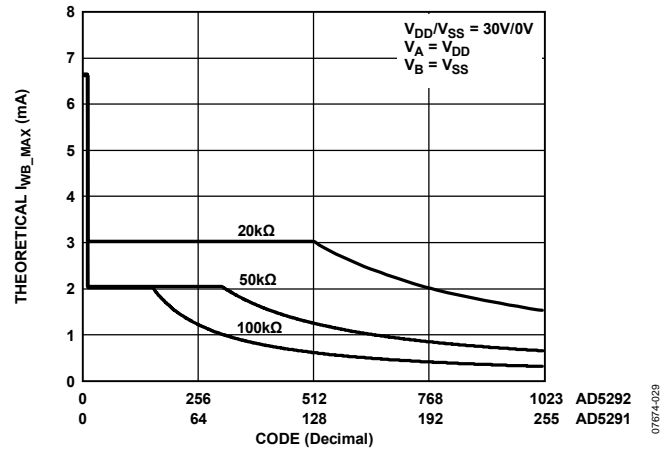

Figure 51. Theoretical Maximum Current vs. Code

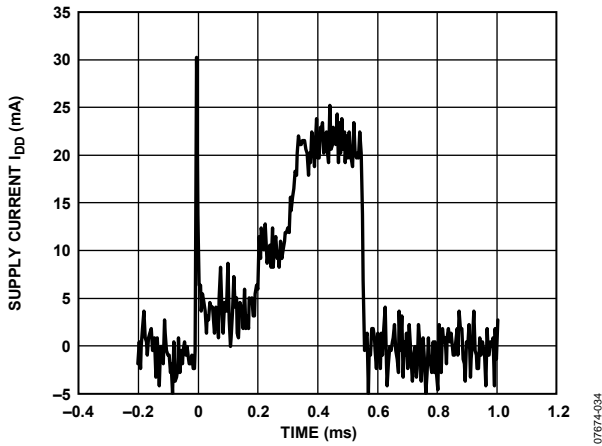

Figure 49.  $I_{DD}$  Waveform While Blowing/Reading Fuse

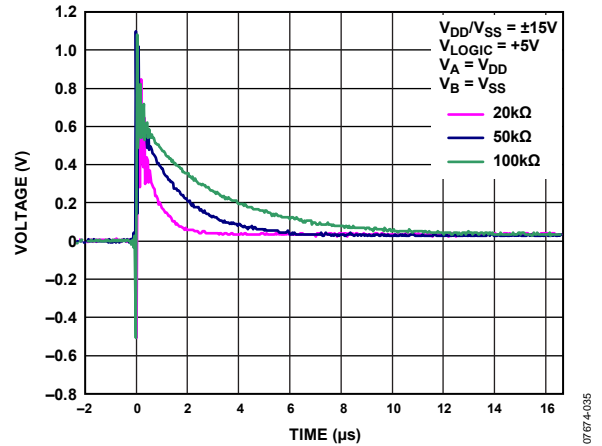

Figure 52. Maximum Transition Glitch

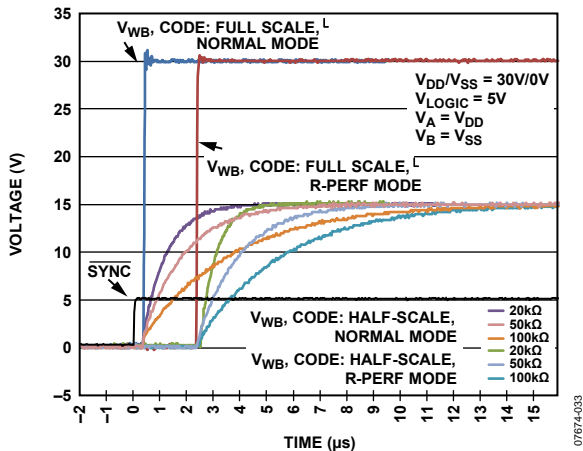

Figure 50. 20kΩ Large-Signal Settling Time from Code Zero Scale

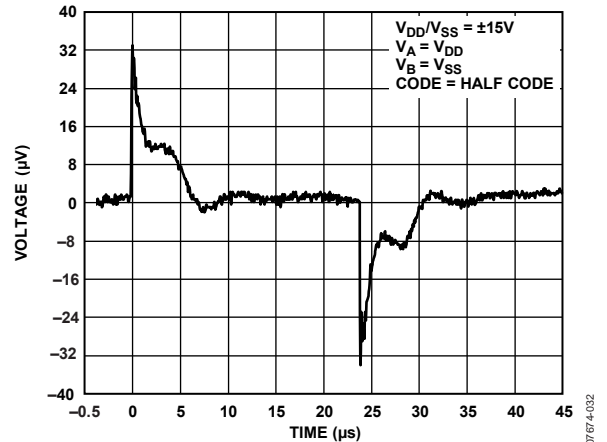

Figure 53. Digital Feedthrough

# AD5291/AD5292

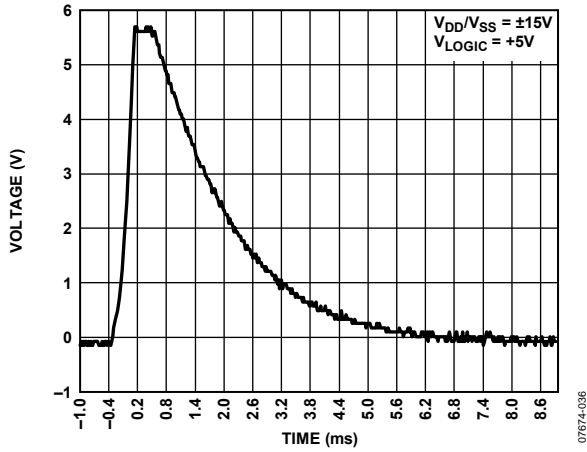

Figure 54.  $V_{EXT\_CAP}$  Waveform While Reading Fuse Or Calibration

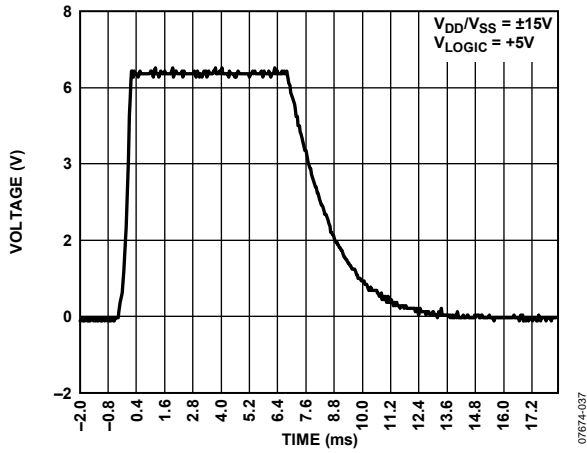

Figure 55.  $V_{EXT\_CAP}$  Waveform While Writing Fuse

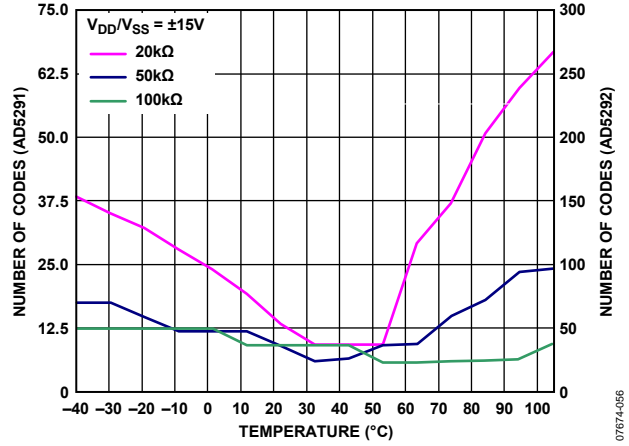

Figure 56. Code Range > 1% R-Tolerance Error vs. Temperature

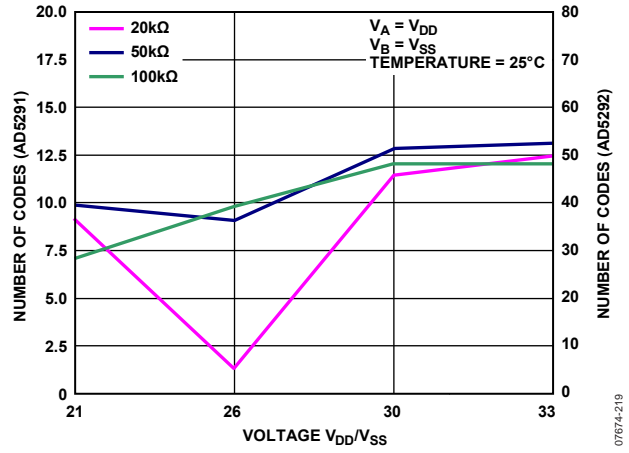

Figure 57. Code Range > 1% R-Tolerance Error vs. Voltage

## TEST CIRCUITS

Figure 58 to Figure 63 define the test conditions used in the Specifications section.

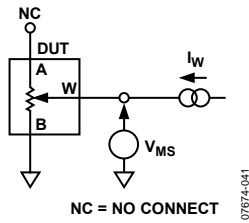

Figure 58. Resistor Position Nonlinearity Error (Rheostat Operation; R-INL, R-DNL)

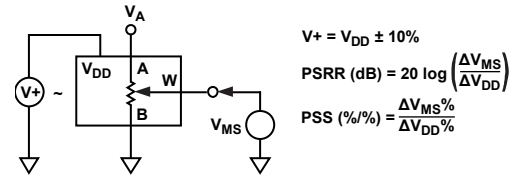

Figure 61. Power Supply Sensitivity (PSS, PSRR)

$$V+ = V_{DD} \pm 10\%$$

$$PSRR \text{ (dB)} = 20 \log \left( \frac{\Delta V_{MS}}{\Delta V_{DD}} \right)$$

$$PSS \text{ (%/%) } = \frac{\Delta V_{MS}\%}{\Delta V_{DD}\%}$$

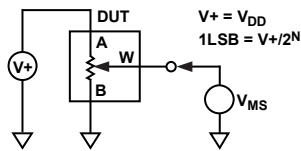

Figure 59. Potentiometer Divider Nonlinearity Error (INL, DNL)

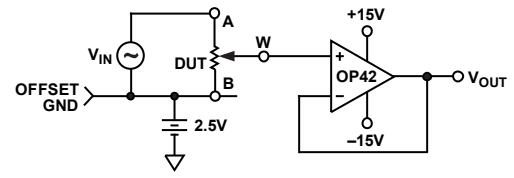

Figure 62. Gain vs. Frequency

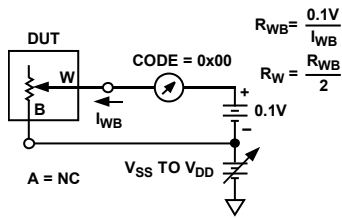

Figure 60. Wiper Resistance

$$R_{WB} = \frac{0.1V}{I_{WB}}$$

$$R_W = \frac{R_{WB}}{2}$$

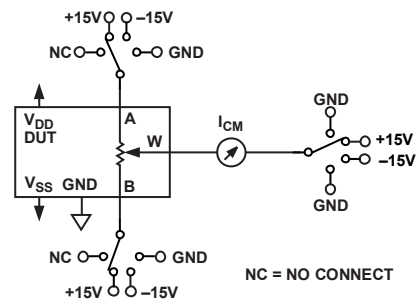

Figure 63. Common-Mode Leakage Current

## THEORY OF OPERATION

The AD5291 and AD5292 digital potentiometers are designed to operate as true variable resistors for analog signals that remain within the terminal voltage range of  $V_{SS} < V_{TERM} < V_{DD}$ . The patented  $\pm 1\%$  resistor tolerance feature helps to minimize the total RDAC resistance error, which reduces the overall system error by offering better absolute matching and improved open-loop performance. The digital potentiometer wiper position is determined by the RDAC register contents. The RDAC register acts as a scratchpad register, allowing as many value changes as necessary to place the potentiometer wiper in the correct position. The RDAC register can be programmed with any position setting using the standard SPI interface by loading the 16-bit data-word. Once a desirable position is found, this value can be stored in a 20-TP memory register. Thereafter, the wiper position is always restored to that position for subsequent power-up. The storing of 20-TP data takes approximately 6 ms; during this time, the shift register is locked, preventing any changes from taking place. The RDY pin identifies the completion of this 20-TP storage.

### SERIAL DATA INTERFACE

The AD5291 and AD5292 contain a serial interface ( $\overline{\text{SYNC}}$ , SCLK, DIN and SDO) that is compatible with SPI interface standards, as well as most DSPs. The part allows writing of data via the serial interface to every register.

### SHIFT REGISTER

The AD5291 and AD5292 shift register is 16 bits wide (see Figure 2). The 16-bit input word consists of two unused bits (set to 0), followed by four control bits, and 10 RDAC data bits.

**Table 11. Command Operation Truth Table**

| Command | Command Bits [DB13:DB10] |    |    |    | Data Bits [DB9:DB0] <sup>1</sup> |    |    |    |    |    |    |    |                 |                 | Operation  |
|---------|--------------------------|----|----|----|----------------------------------|----|----|----|----|----|----|----|-----------------|-----------------|--|
|         | C3                       | C2 | C1 | C0 | D9                               | D8 | D7 | D6 | D5 | D4 | D3 | D2 | D1              | D0              |  |
| 0       | 0                        | 0  | 0  | 0  | X                                | X  | X  | X  | X  | X  | X  | X  | X               | X               | NOP command: do nothing.   |
| 1       | 0                        | 0  | 0  | 1  | D9                               | D8 | D7 | D6 | D5 | D4 | D3 | D2 | D1 <sup>2</sup> | D0 <sup>2</sup> | Write contents of serial data to RDAC.   |
| 2       | 0                        | 0  | 1  | 0  | X                                | X  | X  | X  | X  | X  | X  | X  | X               | X               | Read RDAC wiper setting from the SDO output in the next frame.                                   |
| 3       | 0                        | 0  | 1  | 1  | X                                | X  | X  | X  | X  | X  | X  | X  | X               | X               | Store wiper setting: store RDAC setting to 20-TP memory.   |
| 4       | 0                        | 1  | 0  | 0  | X                                | X  | X  | X  | X  | X  | X  | X  | X               | X               | Reset: refresh RDAC with 20-TP stored value.   |
| 5       | 0                        | 1  | 0  | 1  | X                                | X  | X  | X  | X  | D4 | D3 | D2 | D1              | D0              | Read contents of 20-TP memory, or status of 20-TP memory, from the SDO output in the next frame. |
| 6       | 0                        | 1  | 1  | 0  | X                                | X  | X  | X  | X  | X  | D3 | D2 | D1              | D0              | Write contents of serial data to control register.   |
| 7       | 0                        | 1  | 1  | 1  | X                                | X  | X  | X  | X  | X  | X  | X  | X               | X               | Read control register from the SDO output in the next frame.                                     |
| 8       | 1                        | 0  | 0  | 0  | X                                | X  | X  | X  | X  | X  | X  | X  | X               | D0              | Software shutdown.<br>D0 = 0 (normal mode).<br>D0 = 1 (device placed in shutdown mode).          |

<sup>1</sup> X = don't care.

<sup>2</sup> In the AD5291, this bit is a don't care.

For the AD5291, the lower two RDAC data bits are don't cares if the RDAC register is read from or written to. Data is loaded MSB first (Bit DB15). The four control bits determine the function of the software command (see Table 11). Figure 3 shows a timing diagram of a typical AD5291 and AD5292 write sequence.

The write sequence begins by bringing the  $\overline{\text{SYNC}}$  line low. The  $\overline{\text{SYNC}}$  pin must be held low until the complete data-word is loaded from the DIN pin. When  $\overline{\text{SYNC}}$  returns high, the serial data-word is decoded according to the commands in Table 11. The command bits (Cx) control the operation of the digital potentiometer. The data bits (Dx) are the values that are loaded into the decoded register. The AD5291 and AD5292 have an internal counter that counts a multiple of 16 bits (a frame) for proper operation. For example, AD5291 and AD5292 work with a 32-bit word but does not work properly with a 31-bit or 33-bit word. The AD5291 and AD5292 do not require a continuous SCLK, when  $\overline{\text{SYNC}}$  is high, and all serial interface pins should be operated at close to the  $V_{\text{LOGIC}}$  supply rails to minimize power consumption in the digital input buffers.

### RDAC REGISTER

The RDAC register directly controls the position of the digital potentiometer wiper. For example, when the RDAC register is loaded with all zeros, the wiper is connected to Terminal B of the variable resistor. The RDAC register is a standard logic register; there is no restriction on the number of changes allowed.

## 20-TP MEMORY

Once a desirable wiper position is found, the contents of the RDAC register can be saved into a 20-TP memory register (see Table 12). Thereafter, the wiper position is always set at that position for any future on-off-on power supply sequence. The AD5291 and AD5292 have an array of 20 one-time programmable (OTP) memory registers. When the desired word is programmed to 20-TP memory, the device automatically verifies that the program command was successful. The verification process includes margin testing. Bit C3 of the control register can be polled to verify that the fuse program command was successful. Programming data to 20-TP memory consumes approximately 25 mA for 550  $\mu$ s and takes approximately 8 ms to complete. During this time, the shift register is locked, preventing any changes from taking place. The RDY pin can be used to monitor the completion of the 20-TP memory program and verification. No change in supply voltage is required to program the 20-TP memory. However, a 1  $\mu$ F capacitor on the EXT\_CAP pin is required (see Figure 68). Prior to 20-TP activation, the AD5291 and AD5292 preset to midscale on power-up.

## WRITE PROTECTION

On power-up, the shift register write commands for both the RDAC register and the 20-TP memory register are disabled. The RDAC write protect bit, C1 of the control register (see Table 13 and Table 14), is set to 0 by default. This disables any change of the RDAC register content regardless of the software commands, except that the RDAC register can be refreshed from the 20-TP memory using the software reset command (Command 4) or through hardware by the  $\overline{\text{RESET}}$  pin. To enable programming of the variable resistor wiper position (programming the RDAC register), the write protect bit, C1 of the control register, must first be programmed. This is accomplished by loading the shift register with Command 6 (see Table 11). To enable programming of the 20-TP memory block bit, C0 of the control register (set to 0 by default) must first be set to 1.

**Table 12. Write and Read to RDAC and 20-TP Memory**

| DIN    | SDO    | Action  |
|--------|--------|---|
| 0x1803 | 0xXXXX | Enable update of wiper position and 20-TP memory contents through digital interface.  |
| 0x0500 | 0x1803 | Write 0x100 to the RDAC register; wiper moves to $\frac{1}{4}$ full-scale position.   |
| 0x0800 | 0x0500 | Prepare data read from the RDAC register.   |
| 0x0C00 | 0x0100 | Stores RDAC register content into 20-TP memory. The 16-bit word appears out of SDO, where the last 10 bits contain the contents of the RDAC register (0x100).                 |
| 0x1C00 | 0x0C00 | Prepare data read from the control register.  |
| 0x0000 | 0x000X | NOP Instruction 0 sends 16-bit word out of SDO, where the last four bits contain the contents of the control register. If Bit C3 = 1, the fuse program command is successful. |

**Table 13. Control Register Bit Map<sup>1</sup>**

| DB9 | DB8 | DB7 | DB6 | DB5 | DB4 | DB3 | DB2 | DB1 | DB0 |
|-----|-----|-----|-----|-----|-----|-----|-----|-----|-----|
| X   | X   | X   | X   | X   | X   | C3  | C2  | C1  | C0  |

<sup>1</sup> X = don't care.

**Table 14. Control Register Function**

| Bit Name | Description  |
|----------|--|
| C0       | 20-TP program enable<br>0 = 20-TP program disabled (default)<br>1 = enable device for 20-TP program  |
| C1       | RDAC register write protect<br>0 = wiper position frozen to value in memory (default) <sup>1</sup><br>1 = allow update of wiper position through digital Interface |
| C2       | Calibration enable<br>0 = resistor performance mode enabled (default)<br>1 = normal mode enabled   |
| C3       | 20-TP memory program success<br>0 = fuse program command unsuccessful (default)<br>1 = fuse program command successful   |

<sup>1</sup> Wiper position frozen to value last programmed in 20-TP memory. Wiper is frozen to midscale if 20-TP memory has not been previously programmed.

# AD5291/AD5292

## BASIC OPERATION

The basic mode of setting the variable resistor wiper position (programming the RDAC register) is accomplished by loading the shift register with Command 1 (see Table 11) and the desired wiper position data. When the desired wiper position is determined, the user can load the shift register with Command 3 (see Table 11), which stores the wiper position data in the 20-TP memory register. After 6 ms, the wiper position is permanently stored in the 20-TP memory. The RDY pin can be used to monitor the completion of this 20-TP program. Table 12 provides a programming example, listing the sequence of serial data input (DIN) words with the serial data output appearing at the SDO pin in hexadecimal format.

## 20-TP READBACK AND SPARE MEMORY STATUS

It is possible to read back the contents of any of the 20-TP memory registers through SDO by using Command 5 (see Table 11). The lower five LSB bits (D0 to D4) of the data byte select which memory location is to be read back (see Table 16). Data from the selected memory location are clocked out of the SDO pin during the next SPI operation, where the last 10 bits contain the contents of the specified memory location.

It is also possible to calculate the address of the most recently programmed memory location by reading back the contents of

read-only Memory Address 0x14 and Memory Address 0x15 using Command 5. The data bytes read back from Memory Address 0x014 and Memory Address 0x015 are thermometer encoded versions of the address of the last programmed memory location.

For the example outlined in Table 15, the address of the last programmed location is calculated as

$$(Number\ of\ Bits = 1\ in\ Memory\ Address\ 0x14) + (Number\ of\ Bits = 1\ in\ Memory\ Address\ 0x15) - 1 = 10 + 8 - 1 = 17\ (0x10)$$

If no memory location has been programmed, then the address generated is -1.

## SHUTDOWN MODE

The AD5291 and AD5292 can be placed in shutdown mode by executing the software shutdown command, Command 8 (see Table 11), and setting the LSB, D0, to 1. This feature places the RDAC in a special state in which Terminal A is open-circuited, and Wiper W is connected to Terminal B. The contents of the RDAC register are unchanged by entering shutdown mode. However, all commands listed in Table 11 are supported while in shutdown mode. Execute Command 8 (see Table 11), and set the LSB, D0, to 0 to exit shutdown mode.

**Table 15. Example 20-TP Memory Readback**

| DIN    | SDO    | Action   |
|--------|--------|--|
| 0x1414 | 0xXXXX | Prepares data read from Memory Address 0x14.   |
| 0x1415 | 0x03FF | Prepares data read from Memory Address 0x15. Sends 16-bit word out of SDO, where the last 10 bits contain the contents of Memory Address 0x14. |
| 0x0000 | 0x00FF | NOP Command 0 sends 16-bit word out of SDO, where last 10-bits contain the contents of Memory Address 0x15.                                    |
| 0x1410 | 0x0000 | Prepares data read from memory location 0x10.  |
| 0x0000 | 0xXXXX | NOP Instruction 0 sends 16-bit word out of SDO, where the last 10 bits contain the contents of Memory Address 0x10 (17).                       |

**Table 16. Memory Map of Command 5**

| Data Bits [DB9:DB0] <sup>1</sup> |     |     |     |     |     |     |     |     |     | Register Contents  |
|----------------------------------|-----|-----|-----|-----|-----|-----|-----|-----|-----|--|
| D9                               | D8  | D7  | D6  | D5  | D4  | D3  | D2  | D1  | D0  |  |
| X                                | X   | X   | X   | X   | 0   | 0   | 0   | 0   | 0   | 1 <sup>st</sup> programmed wiper location (0x00)                   |
| X                                | X   | X   | X   | X   | 0   | 0   | 0   | 0   | 1   | 2 <sup>nd</sup> programmed wiper location (0x01)                   |
| X                                | X   | X   | X   | X   | 0   | 0   | 0   | 1   | 0   | 3 <sup>rd</sup> programmed wiper location (0x02)                   |
| X                                | X   | X   | X   | X   | 0   | 0   | 0   | 1   | 1   | 4 <sup>th</sup> programmed wiper location (0x03)                   |
| X                                | X   | X   | X   | X   | 0   | 0   | 1   | 0   | 0   | 5 <sup>th</sup> programmed wiper location (0x04)                   |
| ...                              | ... | ... | ... | ... | ... | ... | ... | ... | ... | ...  |
| X                                | X   | X   | X   | X   | 0   | 1   | 0   | 0   | 1   | 10 <sup>th</sup> programmed wiper location (0x09)                  |
| X                                | X   | X   | X   | X   | 0   | 1   | 1   | 1   | 0   | 15 <sup>th</sup> programmed wiper location (0x0E)                  |
| X                                | X   | X   | X   | X   | 1   | 0   | 0   | 1   | 1   | 20 <sup>th</sup> programmed wiper location (0x13)                  |
| X                                | X   | X   | X   | X   | 1   | 0   | 1   | 0   | 0   | Programmed memory status (thermometer encoded) <sup>2</sup> (0x14) |
| X                                | X   | X   | X   | X   | 1   | 0   | 1   | 0   | 1   | Programmed memory status (thermometer encoded) <sup>2</sup> (0x15) |

<sup>1</sup> X = don't care.

<sup>2</sup> Allows the user to calculate the remaining spare memory locations.



## RESISTOR PERFORMANCE MODE

This mode activates a new, patented 1% end-to-end resistor tolerance that ensures a  $\pm 1\%$  resistor tolerance on each code, that is, code = half scale,  $R_{WB} = 10\text{ k}\Omega \pm 100\ \Omega$ . See Table 2 (AD5291) or Table 5 (AD5292) to check which codes achieve  $\pm 1\%$  resistor tolerance. The resistor performance mode is activated by programming Bit C2 of the control register (see Table 13 and Table 14). The typical settling time is shown in Figure 50.

## RESET

A low-to-high transition of the hardware  $\overline{\text{RESET}}$  pin loads the RDAC register with the contents of the most recently programmed 20-TP memory location. The AD5291 and AD5292 can also be reset through software by executing Command 4 (see Table 11). If no 20-TP memory location is programmed, then the RDAC register loads with midscale upon reset. The control register is restored with default bits; see Table 14.

## SDO PIN AND DAISY-CHAIN OPERATION

The serial data output pin (SDO) serves two purposes: it can be used to read the contents of the wiper setting, 50-TP values and control register using Command 2, Command 5 and Command 7, respectively (see Table 11) or the SDO pin can be used in daisy-chain mode. Data is clocked out of SDO on the rising edge of SCLK. The SDO pin contains an open-drain N-channel FET that requires a pull-up resistor if this pin is used. To place the pin in high impedance and minimize the power dissipation when the pin is used, the 0x8001 data word followed by Command 0 should be sent to the part. Table 17 provides a sample listing for the sequence of the serial data input (DIN). Daisy chaining minimizes the number of port pins required from the controlling IC. As shown in Figure 64, users need to tie the SDO pin of one package to the DIN pin of the next package. Users may need to increase the clock period, because the pull-up resistor and the capacitive loading at the SDO-to-DIN interface may require additional time delay between subsequent devices.

When two AD5291 and AD5292 devices are daisy-chained, 32 bits of data are required. The first 16 bits go to U2, and the second 16 bits go to U1. Hold the  $\overline{\text{SYNC}}$  pin low until all 32 bits are clocked into their respective shift registers. The  $\overline{\text{SYNC}}$  pin is then pulled high to complete the operation.

Keep the  $\overline{\text{SYNC}}$  pin low until all 32 bits are clocked into their respective serial registers. The  $\overline{\text{SYNC}}$  pin is then pulled high to complete the operation.

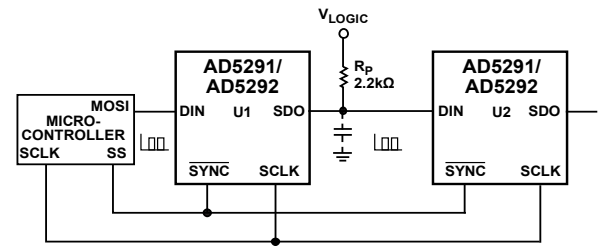

Figure 64. Daisy-Chain Configuration Using SDO

## RDAC ARCHITECTURE

To achieve optimum performance, Analog Devices has patented the RDAC segmentation architecture for all the digital potentiometers. In particular, the AD5291 and AD5292 employ a three-stage segmentation approach, as shown in Figure 65. The AD5291 and AD5292 wiper switches are designed with the transmission gate CMOS topology and with the gate voltages derived from  $V_{DD}$  and  $V_{SS}$ .

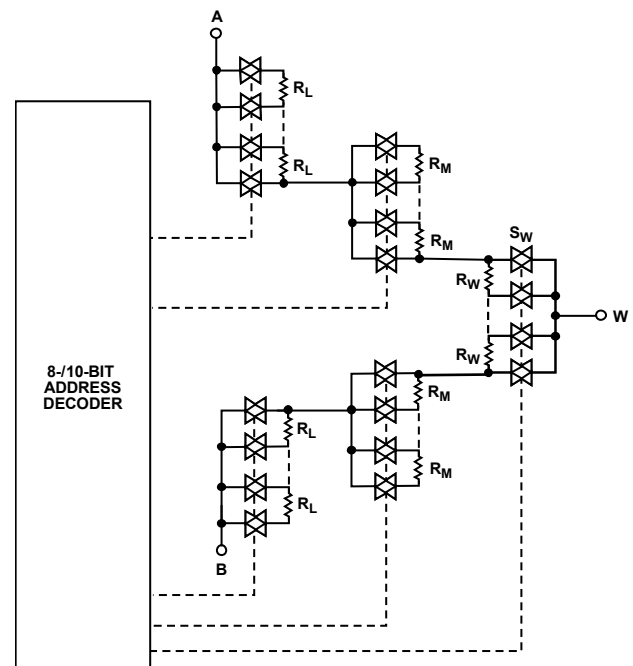

Figure 65. Simplified RDAC Circuit

Table 17. Minimize Power Dissipation at SDO Pin

| DIN    | SDO <sup>1</sup> | Action   |
|--------|------------------|--|
| 0xXXXX | 0xXXXX           | Last user command sent to the digipot                    |
| 0x8001 | 0xXXXX           | Prepares the SDO pin to be placed in high impedance mode |
| 0x0000 | High impedance   | The SDO pin is placed in high impedance                  |

<sup>1</sup> X is don't care.

## PROGRAMMING THE VARIABLE RESISTOR

### Rheostat Operation—1% Resistor Tolerance

The AD5291 and AD5292 operate in rheostat mode when only two terminals are used as a variable resistor. The unused terminal can be left floating or tied to the W terminal, as shown in Figure 66.

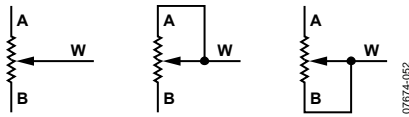

Figure 66. Rheostat Mode Configuration

The nominal resistance between Terminal A and Terminal B,  $R_{AB}$ , is available in 20 k $\Omega$ , 50 k $\Omega$ , and 100 k $\Omega$ , and 256 or 1024 tap points accessed by the wiper terminal. The 8-/10-bit data in the RDAC latch is decoded to select one of the 256/1024 possible wiper settings. The AD5291 and AD5292 contain an internal  $\pm 1\%$  resistor performance mode that can be disabled or enabled (this is enabled by default), by programming Bit C2 of the control register (see Table 13 and Table 14). The digitally programmed output resistance between the W terminal and the A terminal,  $R_{WA}$ , and between the W terminal and B terminal,  $R_{WB}$ , is internally calibrated to give a maximum of  $\pm 1\%$  absolute resistance error across a wide code range. As a result, the general equations for determining the digitally programmed output resistance between the W terminal and B terminal are

AD5291:

$$R_{WB}(D) = \frac{D}{256} \times R_{AB} \quad (1)$$

AD5292:

$$R_{WB}(D) = \frac{D}{1024} \times R_{AB} \quad (2)$$

where:

$D$  is the decimal equivalent of the binary code loaded in the 8-/10-bit RDAC register.

$R_{AB}$  is the end-to-end resistance.

Similar to the mechanical potentiometer, the resistance of the RDAC between the W terminal and the A terminal also produces a digitally controlled complementary resistance,  $R_{WA}$ .  $R_{WA}$  is also calibrated to give a maximum of 1% absolute resistance error.  $R_{WA}$  starts at the maximum resistance value and decreases as the data loaded into the latch increases. The general equations for this operation are

AD5291:

$$R_{WA}(D) = \frac{256 - D}{256} \times R_{AB} \quad (3)$$

AD5292:

$$R_{WA}(D) = \frac{1024 - D}{1024} \times R_{AB} \quad (4)$$

where:

$D$  is the decimal equivalent of the binary code loaded in the 8-/10-bit RDAC register.

$R_{AB}$  is the end-to-end resistance.

In the zero-scale condition, a finite total wiper resistance of 120  $\Omega$  is present. Regardless of which setting the part is operating in, take care to limit the current between Terminal A and Terminal B, between Terminal W and Terminal A, and between Terminal W and Terminal B, to the maximum continuous current of  $\pm 3$  mA or to the pulse current specified in Table 8. Otherwise, degradation or possible destruction of the internal resistors may occur.

## PROGRAMMING THE POTENTIOMETER DIVIDER

### Voltage Output Operation

The digital potentiometer easily generates a voltage divider at the wiper to B and at the wiper to A that is proportional to the input voltage at A to B, as shown in Figure 67. Unlike the polarity of  $V_{DD}$  to GND, which must be positive, voltage across A to B, W to A, and W to B can be at either polarity.

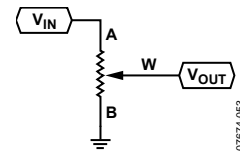

Figure 67. Potentiometer Mode Configuration

If ignoring the effect of the wiper resistance for simplicity, connecting the A terminal to 30 V and the B terminal to ground produces an output voltage at the Wiper W to Terminal B ranging from 0 V to 1 LSB less than 30 V. Each LSB of voltage is equal to the voltage applied across Terminal A and Terminal B, divided by the 256/1024 positions of the potentiometer divider. The general equations defining the output voltage at  $V_W$  with respect to ground for any valid input voltage applied to Terminal A and Terminal B are

AD5291:

$$V_W(D) = \frac{D}{256} \times V_A + \frac{256 - D}{256} \times V_B \quad (5)$$

AD5292:

$$V_W(D) = \frac{D}{1024} \times V_A + \frac{1024 - D}{1024} \times V_B \quad (6)$$

If using the AD5291 and AD5292 in voltage divider mode as shown in Figure 67, then the  $\pm 1\%$  resistor tolerance calibration feature reduces the error when matching with discrete resistors. However, it is recommended to disable the internal  $\pm 1\%$  resistor tolerance calibration feature by programming Bit C2 of the control register (see Table 13 and Table 14) to optimize wiper position update rate. In this configuration, the RDAC is ratiometric and resistor tolerance error does not affect performance.

Operation of the digital potentiometer in the voltage divider mode results in a more accurate operation over temperature. Unlike the rheostat mode, the output voltage is dependent mainly on the ratio of the internal resistors,  $R_{WA}$  and  $R_{WB}$ , and not the absolute values. Therefore, the temperature drift reduces to 5 ppm/°C.

### EXT\_CAP CAPACITOR

A 1  $\mu$ F capacitor to GND must be connected to the EXT\_CAP pin (see Figure 68) on power-up and throughout the operation of the AD5291 and AD5292.

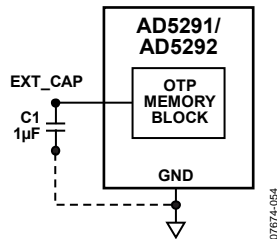

Figure 68. Hardware Setup for EXT\_CAP Pin

### TERMINAL VOLTAGE OPERATING RANGE

The positive  $V_{DD}$  and negative  $V_{SS}$  power supplies of the AD5291 and AD5292 define the boundary conditions for proper 3-terminal digital potentiometer operation. Supply signals present on Terminal A, Terminal B, and Terminal W that exceed  $V_{DD}$  or  $V_{SS}$  are clamped by the internal forward-biased diodes (see Figure 69).

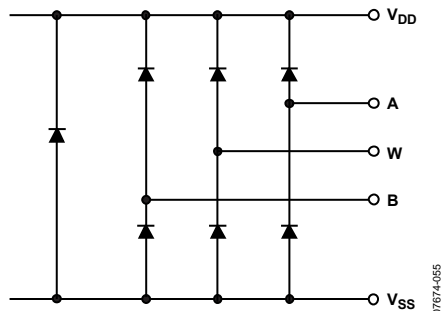

Figure 69. Maximum Terminal Voltages Set by  $V_{DD}$  and  $V_{SS}$

The ground pins of the AD5291 and AD5292 devices are primarily used as a digital ground reference. To minimize the digital ground bounce, the AD5291 and AD5292 ground terminals should be joined remotely to the common ground. The digital input control signals to the AD5291 and AD5292 must be referenced to the device ground pin (GND), and satisfy the logic level defined in the Specifications section.

### Power-Up Sequence

To ensure that the AD5291 and AD5292 power up correctly, a 1  $\mu$ F capacitor must be connected to the EXT\_CAP pin. Because there are diodes to limit the voltage compliance at Terminal A, Terminal B, and Terminal W (see Figure 69), it is important to power  $V_{DD}$  and  $V_{SS}$  first before applying any voltage to Terminal A, Terminal B, and Terminal W. Otherwise, the diode is forward-biased such that  $V_{DD}$  and  $V_{SS}$  are powered up unintentionally. The ideal power-up sequence is GND,  $V_{SS}$ ,  $V_{LOGIC}$  and  $V_{DD}$ , the digital inputs, and then  $V_A$ ,  $V_B$ , and  $V_W$ . The order of powering up  $V_A$ ,  $V_B$ ,  $V_W$ , and the digital inputs is not important as long as they are powered after  $V_{DD}$ ,  $V_{SS}$ , and  $V_{LOGIC}$ .

Regardless of the power-up sequence and the ramp rates of the power supplies, after  $V_{LOGIC}$  is powered, the power-on preset activates, restoring the 20-TP memory value to the RDAC register.

## APPLICATIONS INFORMATION

### HIGH VOLTAGE DAC

The AD5292 can be configured as a high voltage DAC, with output voltage as high as 33 V. The circuit is shown in Figure 70. The output is

$$V_{OUT}(D) = \frac{D}{1024} \times \left[ 1.2 \text{ V} \times \left( 1 + \frac{R_2}{R_1} \right) \right] \quad (7)$$

where  $D$  is the decimal code from 0 to 1023.

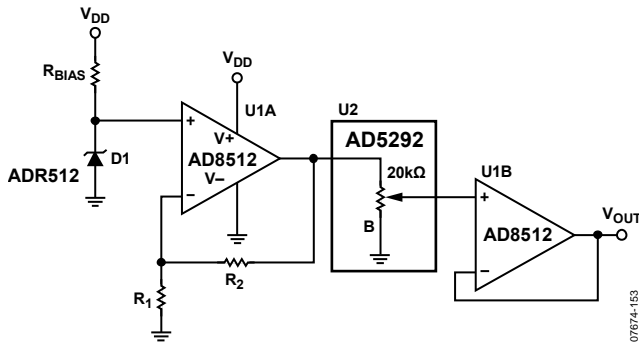

Figure 70. High Voltage DAC

### PROGRAMMABLE VOLTAGE SOURCE WITH BOOSTED OUTPUT

For applications that require high current adjustments such as a laser diode or tunable laser, a boosted voltage source can be considered; see Figure 71.

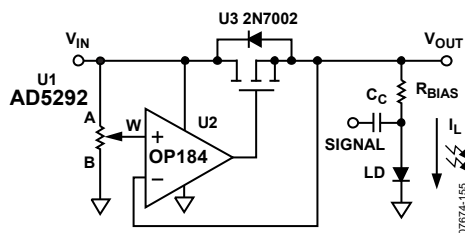

Figure 71. Programmable Boosted Voltage Source

In this circuit, the inverting input of the op amp forces  $V_{OUT}$  to be equal to the wiper voltage set by the digital potentiometer. The load current is then delivered by the supply via the N-channel FET (U3). The N-Channel FET power handling must be adequate to dissipate  $(V_{IN} - V_{OUT}) \times I_L$  power. This circuit can source a maximum of 100 mA with a 33 V supply.

### HIGH ACCURACY DAC

It is possible to configure the AD5292 as a high accuracy DAC by optimizing the resolution of the device over a specific reduced voltage range. This is achieved by placing external resistors on either side of the RDAC, as shown in Figure 72. The improved  $\pm 1\%$  R-Tolerance specification greatly reduces error associated with matching to discrete resistors.

$$V_{OUT}(D) = \frac{R_3 + (D/1024 \times R_{AB}) \times V_{DD}}{R_1 + ((1024-D)/1024) \times R_{AB} + R_3} \quad (8)$$

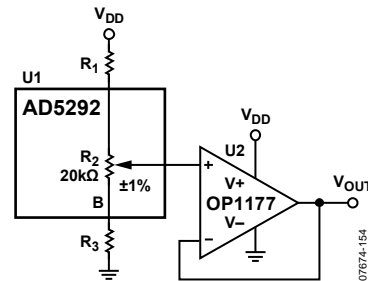

Figure 72. Optimizing Resolution

### VARIABLE GAIN INSTRUMENTATION AMPLIFIER

The AD8221 in conjunction with the AD5291 and AD5292 and the ADG1207, as shown in Figure 73, make an excellent instrumentation amplifier for use in data acquisition systems. The data acquisition system's low distortion and low noise enable it to condition signals in front of a variety of ADCs.

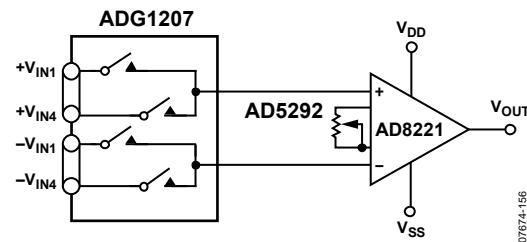

Figure 73. Data Acquisition System

The gain can be calculated by using Equation 9.

$$G(D) = 1 + \frac{49.4 \text{ k}\Omega}{(D/1024) \times R_{AB}} \quad (9)$$

## AUDIO VOLUME CONTROL

The excellent THD performance and high voltage capability make the AD5291 and AD5292 ideal for a digital volume control as an audio attenuator or gain amplifier. A typical problem in these systems is that a large step change in the volume level at any arbitrary time can lead to an abrupt discontinuity of the audio signal causing an audible zipper noise. To prevent this, a zero-crossing window detector can be inserted to the  $\overline{\text{SYNC}}$  line to delay the device update until the audio signal crosses the window. Because the input signal can operate on top of any dc level rather than absolute zero volt level, zero-crossing in this case means the signal is ac-coupled, and the dc offset level is the signal zero reference point.

The configuration to reduce zipper noise is shown in Figure 74, and the results of using this configuration is shown in Figure 75. The input is ac-coupled by C1 and attenuated down before feeding into the window comparator formed by U2, U3, and U4B. U6 is used to establish the signal zero reference. The upper limit of the comparator is set above its offset and, therefore, the output pulses high whenever the input falls between 2.502 V and 2.497 V (or 0.005 V window) in this example. This output is AND'ed with the  $\overline{\text{SYNC}}$  signal such that the AD5291 and AD5292 updates whenever the signal crosses the window. To avoid a constant update of the device, the  $\overline{\text{SYNC}}$  signal should be programmed as two pulses, rather than as one.

In Figure 75, the lower trace shows that the volume level changes from a quarter-scale to full-scale when a signal change occurs near the zero-crossing window.

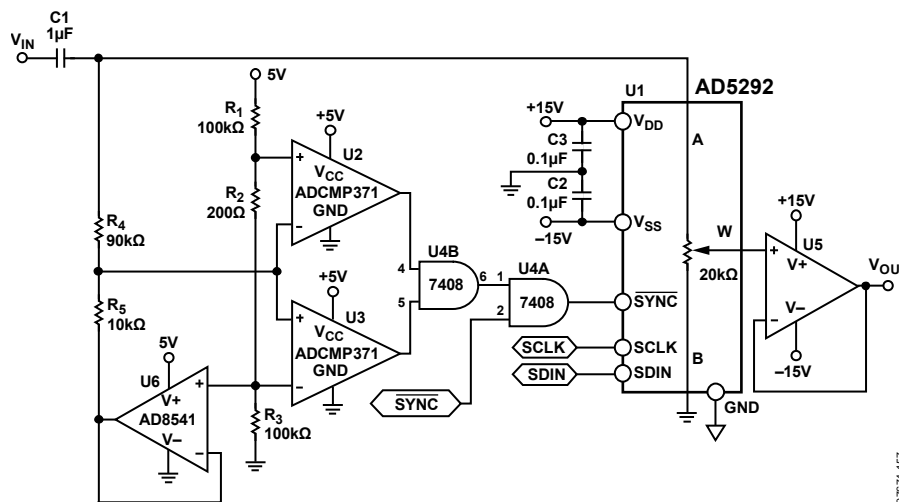

Figure 74. Audio Volume Control with Zipper Noise Reduction

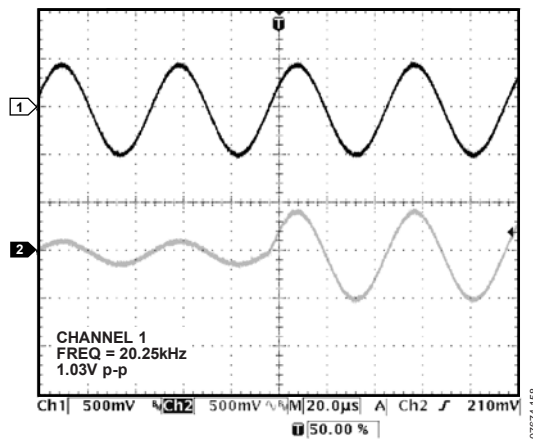
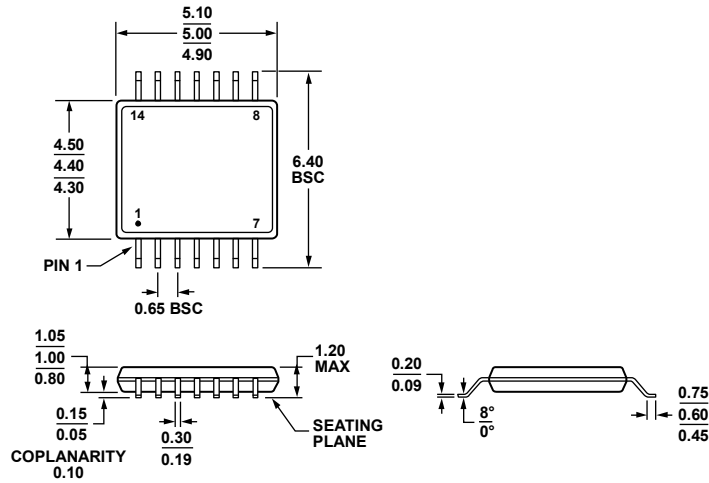

Figure 75. Zipper Noise Detector

# AD5291/AD5292

## OUTLINE DIMENSIONS



COMPLIANT TO JEDEC STANDARDS MO-153-AB-1

Figure 76. 14-Lead Thin Shrink Small Outline Package [TSSOP] (RU-14)

Dimensions shown in millimeters

061908-A

## ORDERING GUIDE

| Model <sup>1</sup> | R <sub>AB</sub> (kΩ) | Resolution | Memory | Temperature Range | Package Description | Package Option |
|--------------------|----------------------|------------|--------|-------------------|---------------------|----------------|
| AD5291BRUZ-20      | 20                   | 256        | 20-TP  | -40°C to +105°C   | 14-Lead TSSOP       | RU-14          |
| AD5291BRUZ-20-RL7  | 20                   | 256        | 20-TP  | -40°C to +105°C   | 14-Lead TSSOP       | RU-14          |
| AD5291BRUZ-50      | 50                   | 256        | 20-TP  | -40°C to +105°C   | 14-Lead TSSOP       | RU-14          |
| AD5291BRUZ-50-RL7  | 50                   | 256        | 20-TP  | -40°C to +105°C   | 14-Lead TSSOP       | RU-14          |
| AD5291BRUZ-100     | 100                  | 256        | 20-TP  | -40°C to +105°C   | 14-Lead TSSOP       | RU-14          |
| AD5291BRUZ-100-RL7 | 100                  | 256        | 20-TP  | -40°C to +105°C   | 14-Lead TSSOP       | RU-14          |
| AD5292BRUZ-20      | 20                   | 1,024      | 20-TP  | -40°C to +105°C   | 14-Lead TSSOP       | RU-14          |
| AD5292BRUZ-20-RL7  | 20                   | 1,024      | 20-TP  | -40°C to +105°C   | 14-Lead TSSOP       | RU-14          |
| AD5292BRUZ-50      | 50                   | 1,024      | 20-TP  | -40°C to +105°C   | 14-Lead TSSOP       | RU-14          |
| AD5292BRUZ-50-RL7  | 50                   | 1,024      | 20-TP  | -40°C to +105°C   | 14-Lead TSSOP       | RU-14          |
| AD5292BRUZ-100     | 100                  | 1,024      | 20-TP  | -40°C to +105°C   | 14-Lead TSSOP       | RU-14          |
| AD5292BRUZ-100-RL7 | 100                  | 1,024      | 20-TP  | -40°C to +105°C   | 14-Lead TSSOP       | RU-14          |
| EVAL-AD5292EBZ     |                      |            |        |                   | Evaluation Board    |                |

<sup>1</sup> Z = RoHS Compliant Part.

**NOTES**

**NOTES**





Компания «ЭлектроПласт» предлагает заключение долгосрочных отношений при поставках импортных электронных компонентов на взаимовыгодных условиях!

Наши преимущества:

- Оперативные поставки широкого спектра электронных компонентов отечественного и импортного производства напрямую от производителей и с крупнейших мировых складов;
- Поставка более 17-ти миллионов наименований электронных компонентов;
- Поставка сложных, дефицитных, либо снятых с производства позиций;
- Оперативные сроки поставки под заказ (от 5 рабочих дней);
- Экспресс доставка в любую точку России;
- Техническая поддержка проекта, помощь в подборе аналогов, поставка прототипов;
- Система менеджмента качества сертифицирована по Международному стандарту ISO 9001;
- Лицензия ФСБ на осуществление работ с использованием сведений, составляющих государственную тайну;
- Поставка специализированных компонентов (Xilinx, Altera, Analog Devices, Intersil, Interpoint, Microsemi, Aeroflex, Peregrine, Syfer, Eurofarad, Texas Instrument, Miteq, Cobham, E2V, MA-COM, Hittite, Mini-Circuits, General Dynamics и др.);

Помимо этого, одним из направлений компании «ЭлектроПласт» является направление «Источники питания». Мы предлагаем Вам помощь Конструкторского отдела:

- Подбор оптимального решения, техническое обоснование при выборе компонента;
- Подбор аналогов;
- Консультации по применению компонента;
- Поставка образцов и прототипов;
- Техническая поддержка проекта;
- Защита от снятия компонента с производства.



#### Как с нами связаться

**Телефон:** 8 (812) 309 58 32 (многоканальный)

**Факс:** 8 (812) 320-02-42

**Электронная почта:** [org@eplast1.ru](mailto:org@eplast1.ru)

**Адрес:** 198099, г. Санкт-Петербург, ул. Калинина, дом 2, корпус 4, литера А.