

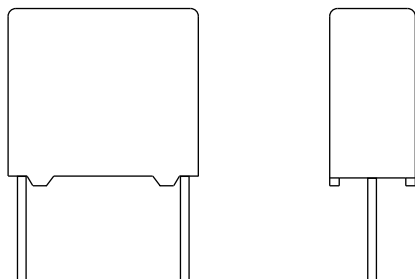

Interference Suppression Film Capacitors MKP Radial Potted Type



FEATURES

- 10 mm to 15 mm lead pitch
- Supplied loose in box, taped on reel
- Material categorization:
for definitions of compliance please see www.vishay.com/doc?99912





RoHS
COMPLIANT

APPLICATIONS

Y2 class

For Y2 electromagnetic interference suppression between line and ground applications (50 Hz / 60 Hz) with a maximum mains voltage of 300 V_{AC}.

For application limitations refer to section "Application Notes".

QUICK REFERENCE DATA	
Capacitance range (E12 series)	0.001 µF to 0.047 µF (preferred values according to E6)
Capacitance tolerance	± 20 %; ± 10 %
Climatic testing class according to EN60068-1	55/105/56/C for product volumes ≤ 1750 mm ³ 55/105/56/B for product volumes > 1750 mm ³
Rated AC voltage	300 V _{AC} ; 50 Hz to 60 Hz
Permissible DC voltage	1000 V _{DC}
Maximum application temperature	105 °C
Reference standards	IEC 60384-14 ed-4 (2013) edition and EN 60384-14 IEC 60065 requires, pass. flamm. class B for volumes > 1750 mm ³ UL 60384-14
Dielectric	Polypropylene film
Electrodes	Metallized film
Construction	Series construction (for > 10 mm pitch)  Triple construction (for > 7.5 mm and 10 mm pitch) 
Encapsulation	Plastic case, epoxy resin sealed, flame retardant UL-class 94 V-0
Leads	Tinned wire
Marking	C-value; tolerance; rated voltage; sub-class; manufacturer's type designation; code for dielectric material; manufacturer location; year and week

Note

- For more detailed data and test requirements, contact: rfi@vishay.com

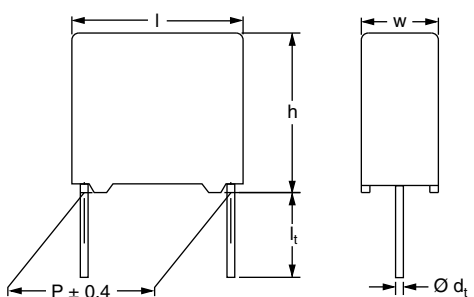
DIMENSIONS in millimeters



COMPOSITION OF CATALOG NUMBER

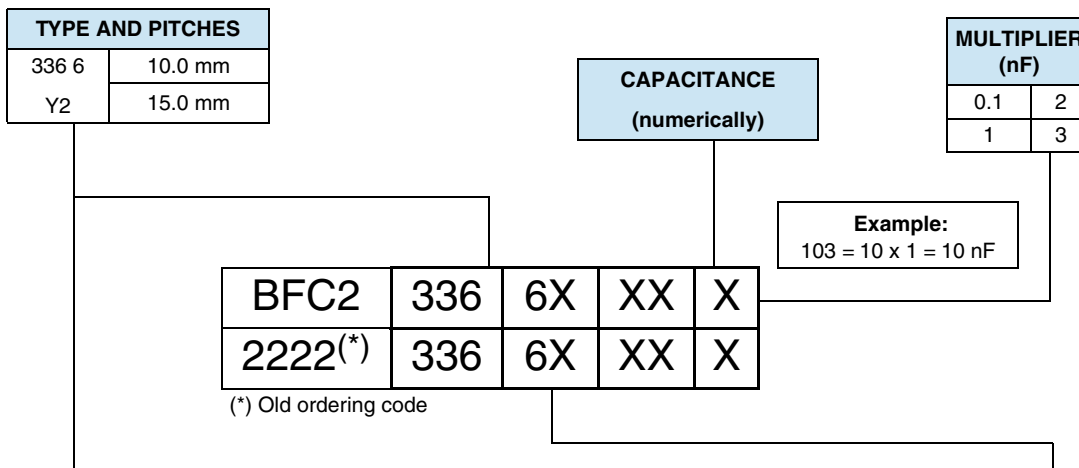

TYPE	PACKAGING	LEAD CONFIGURATION	C-TOL.	PREFERRED TYPES
336 6 Y2	Loose in box	Lead length 3.5 mm + 1 mm/- 0.5 mm (pitch = 10 mm) or 3.5 mm ± 0.3 mm (pitch = 15 mm)	± 20 %	BFC2 336 60...
		Lead length 25.0 mm ± 2.0 mm		BFC2 336 66...
TYPE	PACKAGING	LEAD CONFIGURATION	C-TOL.	ON REQUEST
336 6 Y2	Loose in box	Lead length 3.5 mm + 1 mm/- 0.5 mm (pitch = 10 mm) or 3.5 mm ± 0.3 mm (pitch = 15 mm)	± 10 %	BFC2 336 61...
		Lead length 25.0 mm ± 2.0 mm		BFC2 336 67...
	Taped on reel ⁽¹⁾	H = 18.5 mm; P ₀ = 12.7 mm; reel diameter 500 mm	± 20 %	BFC2 336 63...
			± 10 %	BFC2 336 64...

Note

⁽¹⁾ For detailed tape specification refer to packaging information: www.vishay.com/doc?28139

SPECIFIC REFERENCE DATA	
DESCRIPTION	VALUE
Rated AC voltage (U _{RAC})	300 V
Permissible DC voltage (U _{RDC})	1000 V
Tangent of loss angle	at 10 kHz
	≤ 20 x 10 ⁻⁴
Rated voltage pulse slope (dU/dt) _R at 420 V _{DC}	200 V/μs
R between leads, for C ≤ 0.33 μF at 100 V; 1 min	> 15 000 MΩ
R between leads and case; 100 V; 1 min	> 30 000 MΩ
Withstanding (DC) voltage (cut off current 10 mA) ⁽¹⁾ ; rise time ≤ 1000 V/s	3400 V; 1 min
Withstanding (AC) voltage between leads and case	2100 V; 1 min

Note

⁽¹⁾ See "Voltage Proof Test for Metalized Film Capacitors": www.vishay.com/doc?28169



ELECTRICAL DATA AND ORDERING CODE									
U _{RAC} (V)	CAP. (μF)	DIMENSIONS w x h x l (mm)	MASS (g) ⁽³⁾	CATALOG NUMBER BFC2 336 6..... AND PACKAGING					
				LOOSE IN BOX				REEL (500 mm) ⁽¹⁾⁽²⁾	
				l _t = 3.5 mm + 1 mm/- 0.5 mm (10 mm) OR 3.5 mm ± 0.3 mm (= 15 mm)		l _t = 25.0 mm ± 2.0 mm		H = 18.5 mm; P ₀ = 12.7 mm	
				LAST 5 DIGITS OF CATALOG NUMBER	SPQ	LAST 5 DIGITS OF CATALOG NUMBER	SPQ	LAST 5 DIGITS OF CATALOG NUMBER	SPQ
PITCH = 10.0 mm ± 0.4 mm; d_t = 0.6 mm ± 0.06 mm; C-TOL. = ± 20 %									
300	0.0010	4.0 x 10.0 x 12.5	0.6	60102	1000	66102	1250	63102	1400
	0.0015			60152		66152		63152	
	0.0022			60222		66222		63222	
	0.0033			60332		66332		63332	
	0.0047	5.0 x 11.0 x 12.5	0.82	60472	1000	66472	63472	1100	
	0.0068			60682		66682	63682		
PITCH = 15.0 mm ± 0.4 mm; d_t = 0.6 mm ± 0.06 mm; C-TOL. = ± 20 %									
300	0.0068	5.0 x 11.0 x 17.5	1.0	69005	1000	69009	1000	69006	1100
	0.010			60103		66103		63103	
	0.015	6.0 x 12.0 x 17.5	1.4	60153	66153	63153	900		
PITCH = 15.0 mm ± 0.4 mm; d_t = 0.8 mm ± 0.08 mm; C-TOL. = ± 20 %									
300	0.022	7.0 x 13.5 x 17.5	1.8	60223	750	66223	500	63223	800
	0.033	8.5 x 15.0 x 17.5	2.4	60333		66333		63333	650
	0.047	10.0 x 16.5 x 17.5	3.0	60473	500	66473	450	63473	600
PITCH = 10.0 mm ± 0.4 mm; d_t = 0.6 mm ± 0.06 mm; C-TOL. = ± 10 %									
300	0.0010	4.0 x 10.0 x 12.5	0.6	61102	1000	67102	1250	64102	1400
	0.0012			61122		67122		64122	
	0.0015			61152		67152		64152	
	0.0018			61182		67182		64182	
	0.0022			61222		67222		64222	
	0.0027			61272		67272		64272	
	0.0033			61332		67332		64332	
	0.0039	61392	67392	64392					
	0.0047	5.0 x 11.0 x 12.5	1.1	61472	1000	67472	1000	64472	1100
	0.0056			61562		67562		64562	
PITCH = 15.0 mm ± 0.4 mm; d_t = 0.80 mm ± 0.08 mm; C-TOL. = ± 10 %									
300	0.0056	5.0 x 11.0 x 17.5	1.0	69001	1000	69007	1000	69003	1100
	0.0068			61682		67682		64682	
	0.0082			61822		67822		64822	
	0.010			61103		67103		64103	
	0.012			61123		67123		64123	
	0.015	6.0 x 12.0 x 17.5	1.4	61153	500	67153	450	61153	900
0.018	61183			67183		64183			
PITCH = 15.0 mm ± 0.4 mm; d_t = 0.80 mm ± 0.08 mm; C-TOL. = ± 10 %									
300	0.022	7.0 x 13.5 x 17.5	1.8	61223	750	67223	500	64223	800
	0.027	8.5 x 15.0 x 17.5	2.4	61273		67273		64273	650
	0.033			61333	67333	64333	600		
	0.039	10.0 x 16.5 x 17.5	3.0	61393	500	67393	450	61393	600
	0.047			61473		67473		64473	

Notes

- SPQ = Standard packing quantity
- (1) H = in-tape height; P₀ = sprocket hole distance; for detailed specifications refer to packaging information: www.vishay.com/doc?28139
- (2) Reel diameter = 365 mm is available on request
- (3) Weight for short lead product only



APPROVALS				
SAFETY APPROVALS Y2	VOLTAGE	VALUE	FILE NUMBERS	LINKS
EN 60384-14 (ENEC) (= IEC 60384-14 ed-4 (2013))	300 V _{AC}	1 nF to 47 nF	ENEC16/FI/19/10005	www.vishay.com/doc?28204
UL 60384-14	300 V _{AC}	1 nF to 47 nF	E354331	www.vishay.com/doc?28189
CSA-E384-14	300 V _{AC}	1 nF to 47 nF	E354331	
CB-test-certificate	300 V _{AC}	1 nF to 47 nF	FI-39831	www.vishay.com/doc?28203
The ENEC-approval together with the CB-certificate replace all national marks of the following countries (they have already signed the ENEC-agreement): Austria; Belgium; Czech. Republic; Denmark; Finland; France; Germany; Greece; Hungary; Ireland; Italy; Luxembourg; Netherlands; Norway; Portugal; Slovenian; Spain; Switzerland and United Kingdom.				

MOUNTING

Normal Use

The capacitors are designed for mounting on printed-circuit boards. The capacitors packed in bandoleers are designed for mounting in printed-circuit boards by means of automatic insertion machines.

For detailed tape specifications refer to packaging information: www.vishay.com/doc?28139

Specific Method of Mounting to Withstand Vibration and Shock

In order to withstand vibration and shock tests, it must be ensured that the stand-off pips are in good contact with the printed-circuit board:

- The capacitors shall be mechanically fixed by the leads

Space Requirements on Printed Circuit Board

The maximum space for length (l_{max}), width (w_{max}), and height (h_{max}) of film capacitors to take in account on the printed circuit board is shown in the drawings.

- For products with pitch ≤ 15 mm, $\Delta w = \Delta l = 0.3$ mm; $\Delta h = 0.1$ mm

Eccentricity defined as in drawing. The maximum eccentricity is smaller than or equal to the lead diameter of the product concerned.

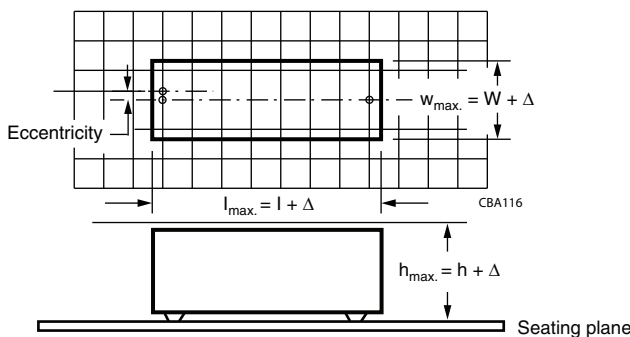

SOLDERING CONDITIONS

For general soldering conditions and wave soldering profile, we refer to the application note: "Soldering Guidelines for Film Capacitors": www.vishay.com/doc?28171

Storage Temperature

$T_{stg} = -25$ °C to $+35$ °C with RH maximum 75 % without condensation

Ratings and Characteristics Reference Conditions

Unless otherwise specified, all electrical values apply to an ambient temperature of 23 °C ± 1 °C, an atmospheric pressure of 86 kPa to 106 kPa and a relative humidity of 50 % ± 2 %.

For reference testing, a conditioning period shall be applied over 96 h ± 4 h by heating the products in a circulating air oven at the rated temperature and a relative humidity not exceeding 20 %.



CHARACTERISTICS

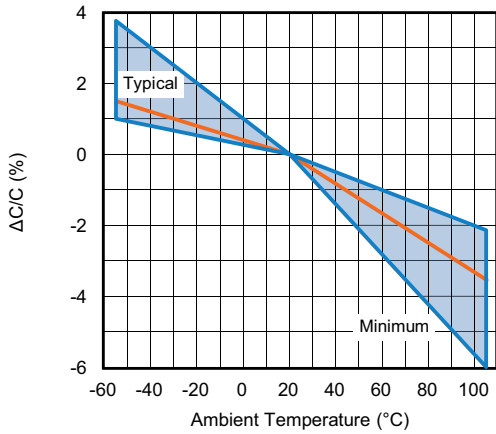

Capacitance as a function of ambient temperature (typical curve)

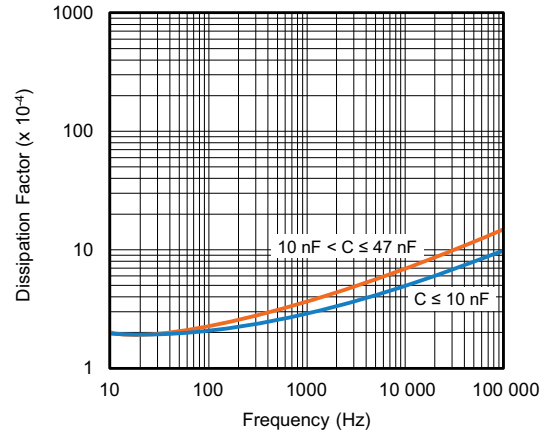

Tangent of loss angle as a function of frequency (typical curve)



Impedance as a function of frequency (typical curve)



Resonant frequency as a function of capacitance (typical curve)



Max. RMS voltage as a function of frequency

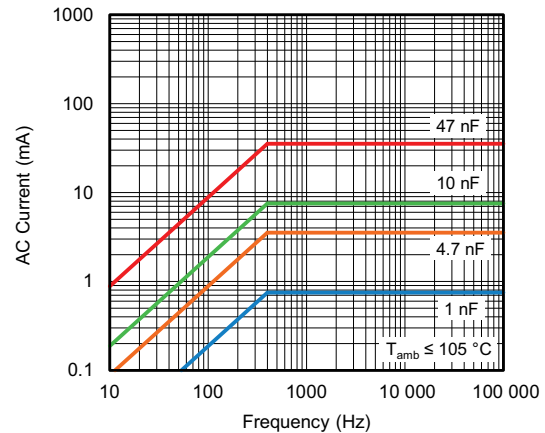

Max. RMS current as a function of frequency

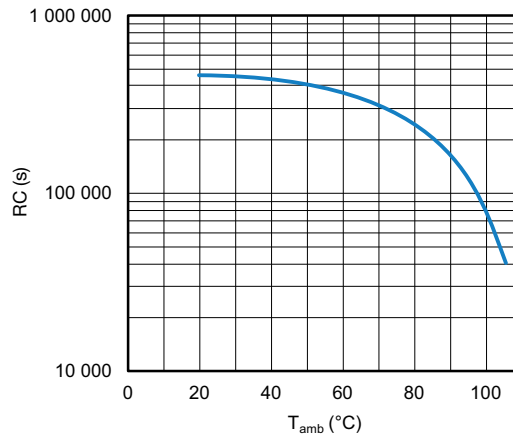

Insulation resistance as a function of ambient temperature (typical curve)

APPLICATION NOTES

- For Y2 electromagnetic interference suppression between line and ground (50 Hz / 60 Hz) with a maximum mains voltage of 300 V_{AC} ± 10 % instability
- For capacitors connected in parallel, normally the proof voltage and possibly the rated voltage must be reduced. For information depending of the capacitance value and the number of parallel connections contact: rfi@vishay.com
- These capacitors are not intended for continuous pulse applications. For these situations, capacitors of the AC and pulse program must be used
- The maximum ambient temperature must not exceed 105 °C
- Rated voltage pulse slope:
if the pulse voltage is lower than the rated voltage, the values of the specific reference data can be multiplied by 420 V_{DC} and divided by the applied voltage



INSPECTION REQUIREMENTS

General Notes

Sub-clause numbers of tests and performance requirements refer to the “Sectional Specification, Publication IEC 60384-14 ed-4 (2013) and Specific Reference Data.”

GROUP C INSPECTION REQUIREMENTS			
SUB-CLAUSE NUMBER AND TEST	D OR ND	CONDITIONS	PERFORMANCE REQUIREMENTS
SUB-GROUP C1A PART OF SAMPLE OF SUB-GROUP C1		D	
4.1 Dimensions (detail)			As specified in chapters “General data” of this specification
Initial measurements		Capacitance Tangent of loss angle at 10 kHz	
4.3 Robustness of terminations		Tensile: Load 10 N; 10 s Bending: Load 5 N; 4 x 90°	No visible damage
4.4 Resistance to soldering heat		No pre-drying Method: 1A Solder bath: 260 °C Duration: 10 s	
4.19 Component solvent resistance		Isopropylalcohol at room temperature Method: 2 Immersion time: 5 min ± 0.5 min Recovery time: Min. 1 h, max. 2 h	
4.4.2 Final measurements		Visual examination	No visible damage Legible marking
		Capacitance	$ \Delta C/C \leq 5\%$ of the value measured initially
		Tangent of loss angle	Increase of $\tan \delta \leq 0.008$ Compared to values measured initially
		Insulation resistance	As specified in section “Insulation Resistance” of this specification
SUB-GROUP C1B PART OF SAMPLE OF SUB-GROUP C1		D	
Initial measurements		Capacitance Tangent of loss angle at 10 kHz	
4.20 Solvent resistance of the marking		Isopropylalcohol at room temperature Method: 1 Rubbing material: Cotton wool Immersion time: 5 min ± 0.5 min	No visible damage Legible marking
4.6 Rapid change of temperature		$\theta A = - 55\text{ °C}$ $\theta B = + 105\text{ °C}$ 5 cycles	
4.6.1 Inspection		Duration $t = 30\text{ min}$	



GROUP C INSPECTION REQUIREMENTS			
SUB-CLAUSE NUMBER AND TEST	D OR ND	CONDITIONS	PERFORMANCE REQUIREMENTS
SUB-GROUP C1B PART OF SAMPLE OF SUB-GROUP C1	D		
4.7 Vibration		Visual examination Mounting: See section "Mounting" of this specification Procedure B4 Frequency range: 10 Hz to 55 Hz. Amplitude: 0.75 mm or Acceleration 98 m/s ² (whichever is less severe) Total duration 6 h	No visible damage
4.7.2 Final inspection		Visual examination	No visible damage
4.9 Shock		Mounting: See section "Mounting" for more information Pulse shape: Half sine Acceleration: 490 m/s ² Duration of pulse: 11 ms	
4.9.2 Final measurements		Visual examination Capacitance Tangent of loss angle Insulation resistance	No visible damage $ \Delta C/C \leq 5\%$ of the value measured initially Increase of tan δ : ≤ 0.008 Compared to values measured initially As specified in section "Insulation Resistance" of this specification
SUB-GROUP C1 COMBINED SAMPLE OF SPECIMENS OF SUB-GROUPS C1A AND C1B	D		
4.11 Climatic sequence			
4.11.1 Initial measurements		Capacitance Measured in 4.4.2 and 4.9.2 Tangent of loss angle: Measured initially in C1A and C1B	
4.11.2 Dry heat		Temperature: 105 °C Duration: 16 h	
4.11.3 Damp heat cyclic Test Db First cycle			
4.11.4 Cold		Temperature: - 55 °C Duration: 2 h	
4.11.5 Damp heat cyclic Test Db remaining cycles			



GROUP C INSPECTION REQUIREMENTS			
SUB-CLAUSE NUMBER AND TEST	D OR ND	CONDITIONS	PERFORMANCE REQUIREMENTS
SUB-GROUP C1 COMBINED SAMPLE OF SPECIMENS OF SUB-GROUPS C1A AND C1B	D		
4.11.6 Final measurements		Visual examination Capacitance Tangent of loss angle Voltage proof 2250 V _{DC} ; 1 min between term. Insulation resistance	No visible damage Legible marking $ \Delta C/C \leq 5\%$ of the value measured in 4.11.1. Increase of tan δ : ≤ 0.008 Compared to values measured in 4.11.1. No permanent breakdown or flash-over $\geq 50\%$ of values specified in section "Insulation resistance" of this specification
SUB-GROUP C2	D		
4.12 Damp heat steady state		56 days, 40 °C, 90 % to 95 % RH no load capacitance	
4.12.1 Initial measurements		Capacitance Tangent of loss angle at 10 kHz	
4.12.3 Final measurements		Visual examination Capacitance Tangent of loss angle Voltage proof 2250 V _{DC} ; 1 min between term. Insulation resistance	No visible damage Legible marking $ \Delta C/C \leq 5\%$ of the value measured in 4.12.1. Increase of tan δ : ≤ 0.007 Compared to values measured in 4.12.1. No permanent breakdown or flash-over $\geq 50\%$ of values specified in section "Insulation resistance" of this specification
SUB-GROUP C3	D		
4.13.1 Initial measurements		Capacitance Tangent of loss angle at 10 kHz	
4.13 Impulse voltage		3 successive impulses, full wave, peak voltage: 5 kV Max. 24 pulses	No selfhealing breakdowns or flashover
4.14 Endurance		Duration: 1000 h 1.7 U _{RAC} at 105 °C Once in every hour the voltage is increased to 1000 V _{RMS} for 0.1 s via resistor of 47 $\Omega \pm 5\%$	



GROUP C INSPECTION REQUIREMENTS			
SUB-CLAUSE NUMBER AND TEST	D OR ND	CONDITIONS	PERFORMANCE REQUIREMENTS
SUB-GROUP C3		D	
4.14.7 Final measurements		Visual examination Capacitance Tangent of loss angle Voltage proof 2250 V _{DC} ; 1 min between terminations Insulation resistance	No visible damage Legible marking $ \Delta C/C \leq 10\%$ compared to values measured in 4.13.1. Increase of tan δ : ≤ 0.007 Compared to values measured in 4.13.1. No permanent breakdown or flash-over $\geq 50\%$ of values specified in section "Insulation resistance" of this specification
SUB-GROUP C4		D	
4.15 Charge and discharge		10 000 cycles (50 c/s) charge to U _R half sinewave Duration: 5 ms Discharge resistance: $R = \frac{420 V_{DC}}{1.5 \times C((dU)/(dt))}$ $R_{min.} = 2.2 \Omega$	
4.15.1 Initial measurements		Capacitance Tangent of loss angle at 10 kHz	
4.15.3 Final measurements		Capacitance Tangent of loss angle Insulation resistance	$ \Delta C/C \leq 10\%$ compared to values measured in 4.15.1. Increase of tan δ : ≤ 0.008 Compared to values measured in 4.15.1. $\geq 50\%$ of values specified in section "Insulation resistance" of this specification
SUB-GROUP C5		D	
4.16 Radio frequency characteristic		Resonance frequency	As specified in section "Resonant frequency" of this specification. $\pm 10\%$

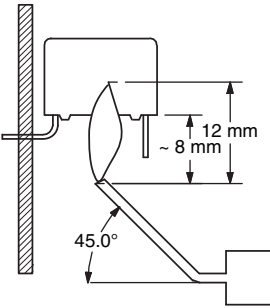

GROUP C INSPECTION REQUIREMENTS			
SUB-CLAUSE NUMBER AND TEST	D OR ND	CONDITIONS	PERFORMANCE REQUIREMENTS
SUB-GROUP C6			
4.17 Passive flammability Class B	D	Bore of gas jet: \varnothing 0.5 mm Fuel: Butane Test duration for actual volume V in mm ³ : V ≤ 250: 10 s 250 < V ≤ 500: 20 s 500 < V ≤ 1750: 30 s V > 1750: 60 s One flame application 	After removing test flame from capacitor, the capacitor must not continue to burn for more than 10 s. No burning particle must drop from the sample.
SUB-GROUP C7			
4.18 Active flammability	D	20 x 5 kV discharges on the test capacitor connected to U _R	The cheese cloth around the capacitors shall not burn with a flame. No electrical measurements are required.



Disclaimer

ALL PRODUCT, PRODUCT SPECIFICATIONS AND DATA ARE SUBJECT TO CHANGE WITHOUT NOTICE TO IMPROVE RELIABILITY, FUNCTION OR DESIGN OR OTHERWISE.

Vishay Intertechnology, Inc., its affiliates, agents, and employees, and all persons acting on its or their behalf (collectively, "Vishay"), disclaim any and all liability for any errors, inaccuracies or incompleteness contained in any datasheet or in any other disclosure relating to any product.

Vishay makes no warranty, representation or guarantee regarding the suitability of the products for any particular purpose or the continuing production of any product. To the maximum extent permitted by applicable law, Vishay disclaims (i) any and all liability arising out of the application or use of any product, (ii) any and all liability, including without limitation special, consequential or incidental damages, and (iii) any and all implied warranties, including warranties of fitness for particular purpose, non-infringement and merchantability.

Statements regarding the suitability of products for certain types of applications are based on Vishay's knowledge of typical requirements that are often placed on Vishay products in generic applications. Such statements are not binding statements about the suitability of products for a particular application. It is the customer's responsibility to validate that a particular product with the properties described in the product specification is suitable for use in a particular application. Parameters provided in datasheets and / or specifications may vary in different applications and performance may vary over time. All operating parameters, including typical parameters, must be validated for each customer application by the customer's technical experts. Product specifications do not expand or otherwise modify Vishay's terms and conditions of purchase, including but not limited to the warranty expressed therein.

Except as expressly indicated in writing, Vishay products are not designed for use in medical, life-saving, or life-sustaining applications or for any other application in which the failure of the Vishay product could result in personal injury or death. Customers using or selling Vishay products not expressly indicated for use in such applications do so at their own risk. Please contact authorized Vishay personnel to obtain written terms and conditions regarding products designed for such applications.

No license, express or implied, by estoppel or otherwise, to any intellectual property rights is granted by this document or by any conduct of Vishay. Product names and markings noted herein may be trademarks of their respective owners.



Компания «ЭлектроПласт» предлагает заключение долгосрочных отношений при поставках импортных электронных компонентов на взаимовыгодных условиях!

Наши преимущества:

- Оперативные поставки широкого спектра электронных компонентов отечественного и импортного производства напрямую от производителей и с крупнейших мировых складов;
- Поставка более 17-ти миллионов наименований электронных компонентов;
- Поставка сложных, дефицитных, либо снятых с производства позиций;
- Оперативные сроки поставки под заказ (от 5 рабочих дней);
- Экспресс доставка в любую точку России;
- Техническая поддержка проекта, помощь в подборе аналогов, поставка прототипов;
- Система менеджмента качества сертифицирована по Международному стандарту ISO 9001;
- Лицензия ФСБ на осуществление работ с использованием сведений, составляющих государственную тайну;
- Поставка специализированных компонентов (Xilinx, Altera, Analog Devices, Intersil, Interpoint, Microsemi, Aeroflex, Peregrine, Syfer, Eurofarad, Texas Instrument, Miteq, Cobham, E2V, MA-COM, Hittite, Mini-Circuits, General Dynamics и др.);

Помимо этого, одним из направлений компании «ЭлектроПласт» является направление «Источники питания». Мы предлагаем Вам помощь Конструкторского отдела:

- Подбор оптимального решения, техническое обоснование при выборе компонента;
- Подбор аналогов;
- Консультации по применению компонента;
- Поставка образцов и прототипов;
- Техническая поддержка проекта;
- Защита от снятия компонента с производства.



Как с нами связаться

Телефон: 8 (812) 309 58 32 (многоканальный)

Факс: 8 (812) 320-02-42

Электронная почта: org@eplast1.ru

Адрес: 198099, г. Санкт-Петербург, ул. Калинина, дом 2, корпус 4, литера А.