

# Analog Devices Welcomes Hittite Microwave Corporation

NO CONTENT ON THE ATTACHED DOCUMENT HAS CHANGED



**THIS PAGE INTENTIONALLY LEFT BLANK**

### Typical Applications

The HMC1081 is ideal for:

- E-Band Communications Systems
- Test Equipment & Sensors
- Military End-Use
- Automotive Radar

### Features

- Passive: No DC Bias Required
- Low LO Power: 12 dBm
- High LO/RF Isolation: 28 dB
- Wide IF Bandwidth: DC to 26 GHz
- Upconversion & Downconversion Applications
- Die Size: 1.23 x 1.21 x 0.1 mm

### Functional Diagram

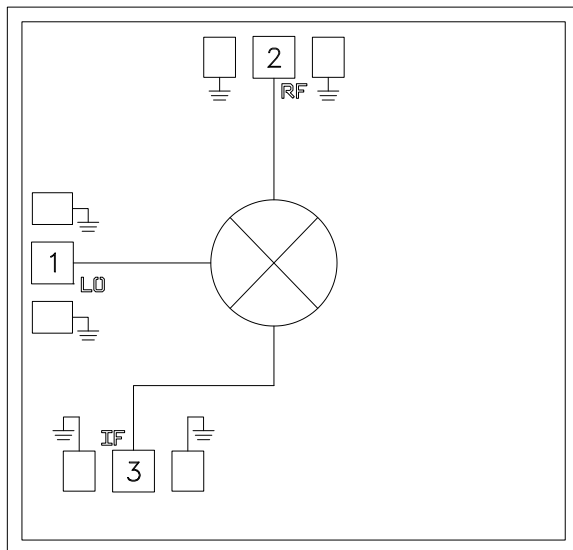

### General Description

The HMC1081 is a double balanced mixer. It can be used as an upconverter or a downconverter, with DC to 26 GHz at the IF port and 50 to 75 GHz at the RF port. This passive MMIC mixer is fabricated with GaAs Shottky diode technology. All bond pads and the die backside are Ti/Au metallized and the Shottky devices are fully passivated for reliable operation. All data shown herein is measured with the chip in a 50 Ohm environment and contacted with RF probes.

### Electrical Specifications, $T_A = +25^\circ C$ , LO = 50 GHz, LO = +12 dBm, USB [1]

Parameter	Min.	Typ.	Max.	Units
RF Frequency Range		50 - 75		GHz
LO Frequency Range		40 - 85		GHz
IF Frequency Range		DC - 26		GHz
Conversion Loss		7.5	10.5	dB
LO to RF Isolation		30		dB
LO to IF Isolation		20		dB
RF to IF Isolation		22		dB
IP3 (Input) <sup>[2]</sup>		16		dBm
1 dB Gain Compression (Input) <sup>[2]</sup>		10		dBm

[1] Unless otherwise noted, all measurements performed as an Upconverter with LO = 50 GHz and LO = +12 dBm.

[2] Measurements performed as an Upconverter with LO = 49 GHz and LO = +12 dBm.



**Conversion Gain vs. Temperature  
LO= 49 GHz, USB**

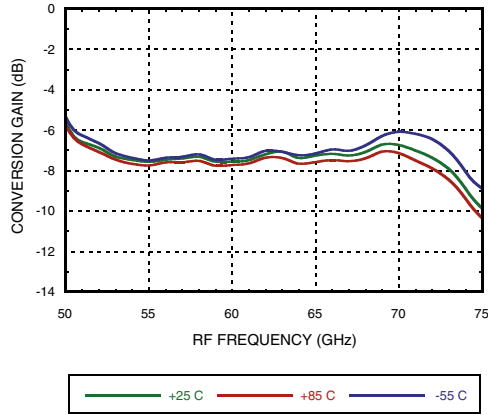

**Conversion Gain vs. LO Power  
LO= 49 GHz, USB**

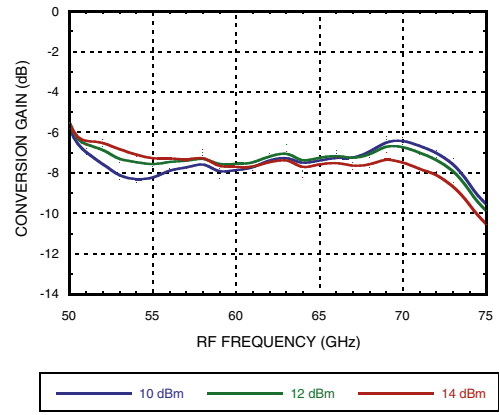

**Conversion Gain vs. Temperature  
LO= 50 GHz, USB**

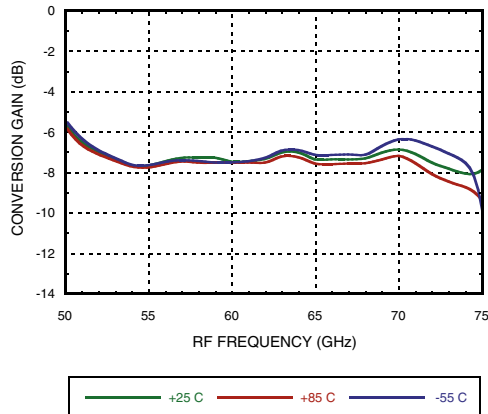

**Conversion Gain vs. LO Power  
LO= 50 GHz, USB**

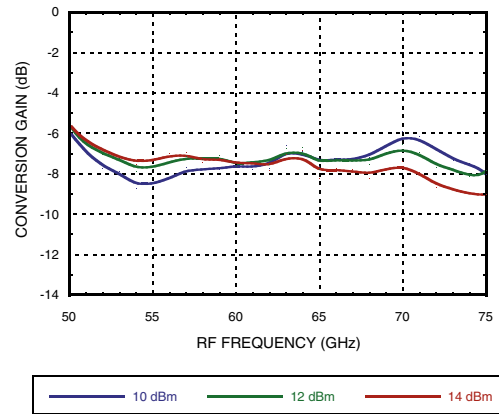

**Conversion Gain vs. Temperature  
LO= 75 GHz, LSB**

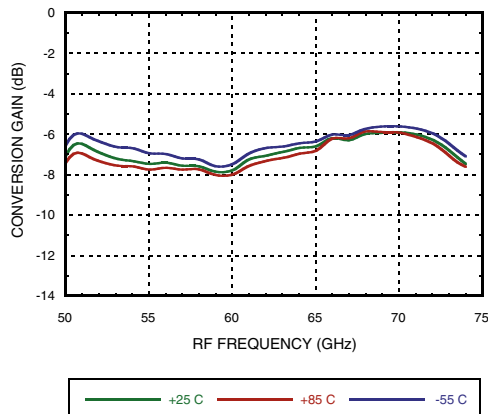

**Conversion Gain vs. LO Power  
LO= 75 GHz, LSB**

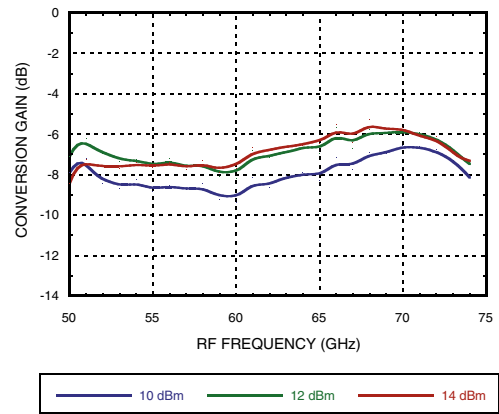



**Conversion Gain vs. LO Power**  
LO= 40 GHz, USB

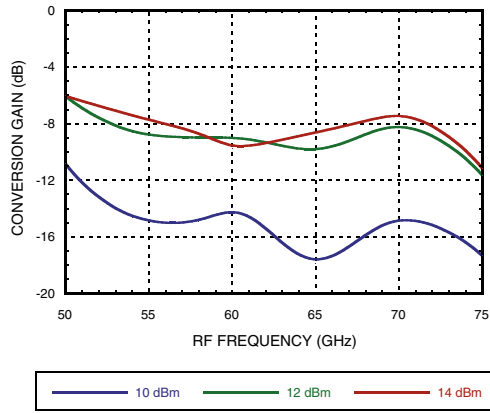

**Conversion Gain vs. LO Power**  
LO= 44 GHz, USB

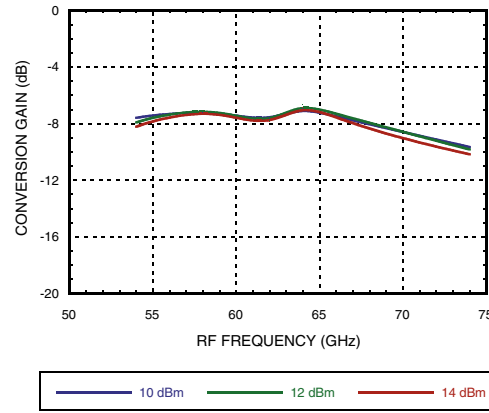

**Conversion Gain vs. LO Power**  
LO= 48 GHz, USB

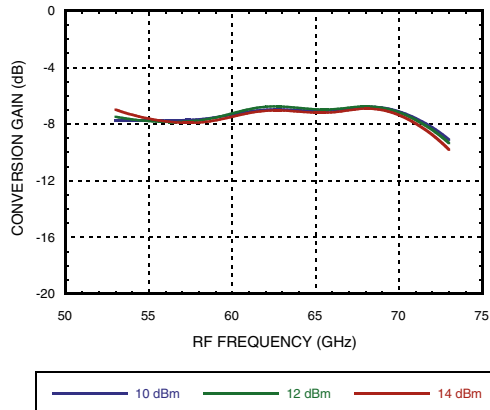

**Conversion Gain vs. LO Power**  
IF= 1 GHz

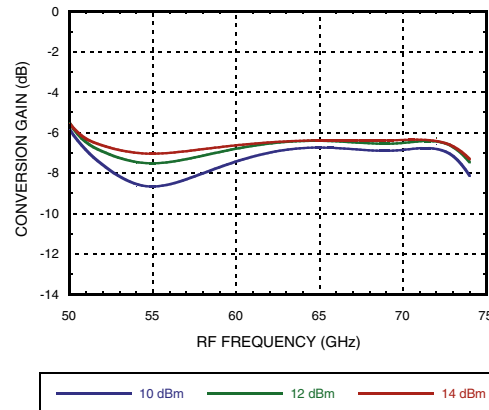

**Conversion Gain vs. LO Power**  
IF= 10 GHz

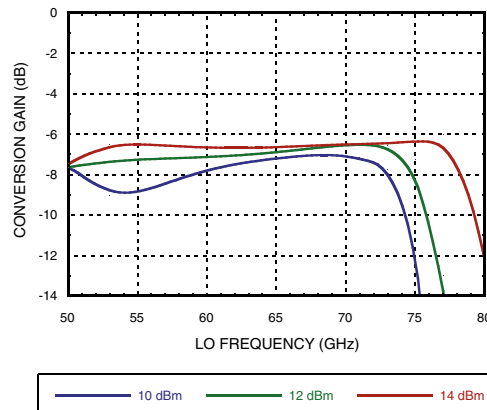

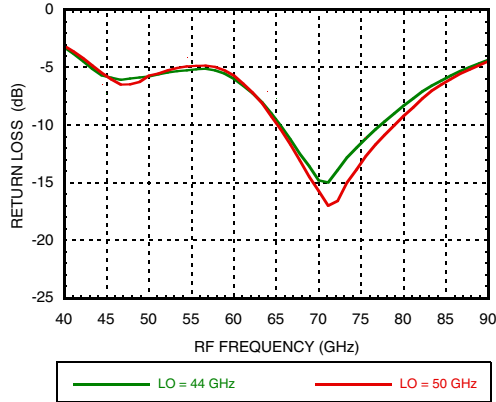
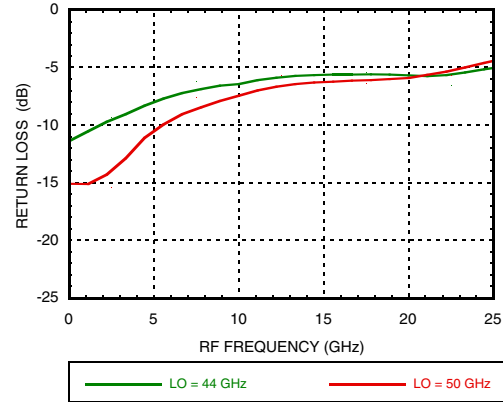
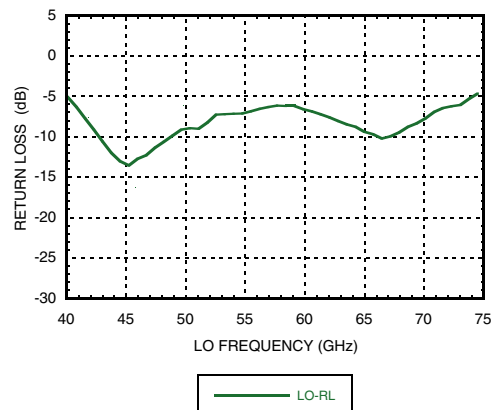
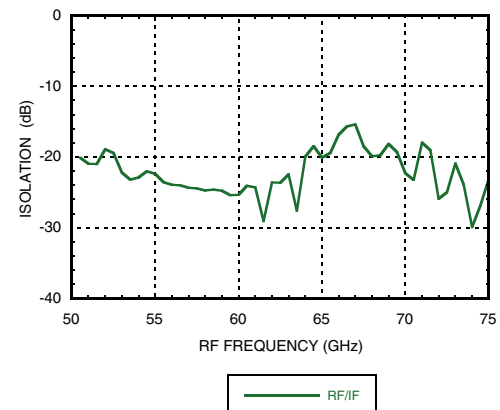
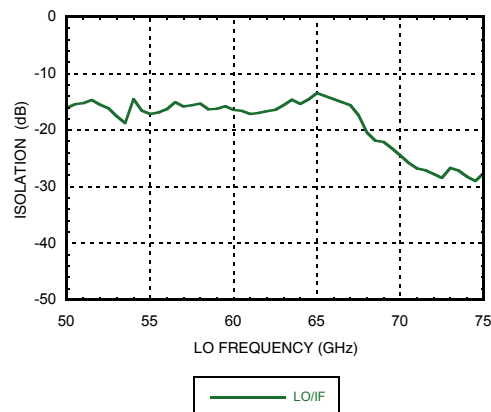
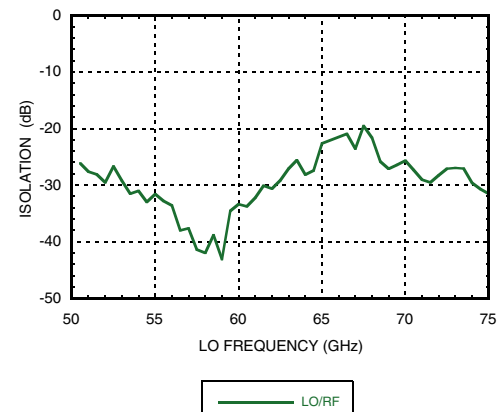
**RF Return Loss**

**IF Return Loss**

**LO Return Loss**

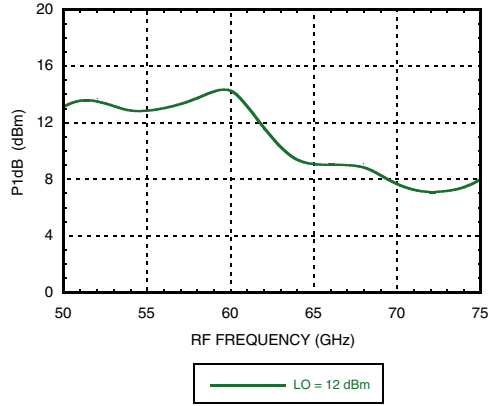
**RF/IF Isolation**

**LO/IF Isolation**

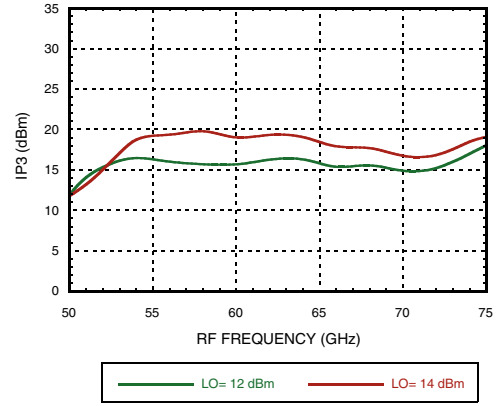
**LO/RF isolation**



**P1dB, LO= 49 GHz, USB**



**Input IP3, LO= 49 GHz, USB**



**Absolute Maximum Ratings**

RF Input	+3 dBm
LO Drive	+20 dBm
IF Input	0 dBm
Maximum Junction Temperature	170 °C
Thermal Resistance (R <sub>TH</sub> ) (junction to die bottom)	823 °C/W
Operating Temperature	-55 to +85 °C
Storage Temperature	-65 to 150 °C
ESD Sensitivity (HBM)	Class1A passed 250V

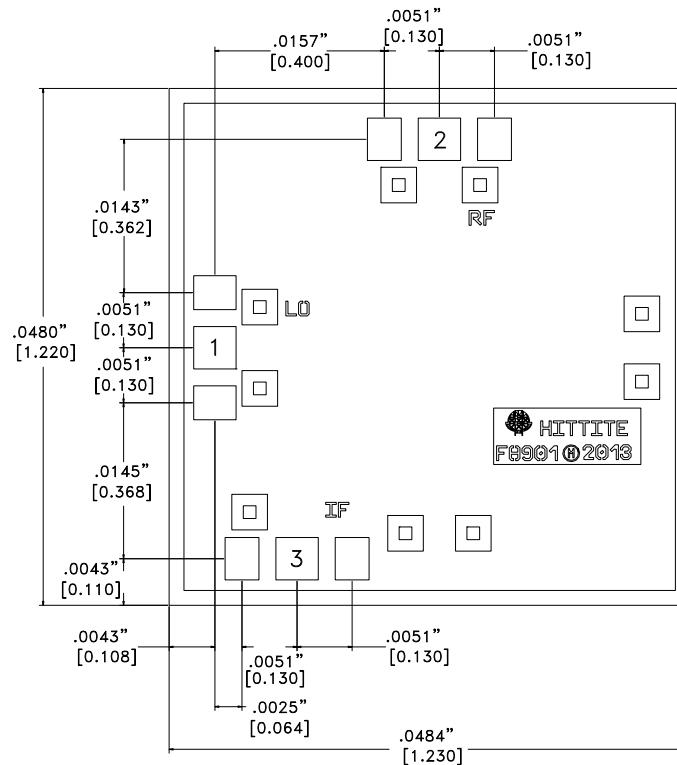
**ELECTROSTATIC SENSITIVE DEVICE  
OBSERVE HANDLING PRECAUTIONS**
**Outline Drawing**

**Die Packaging Information** <sup>[1]</sup>

Standard	Alternate
GP-1 (Gel Pack)	[2]

[1] For more information refer to the "Packaging information" Document in the Product Support Section of our website.

[2] For alternate packaging information contact Hittite Microwave Corporation.

**NOTES:**

1. ALL DIMENSIONS ARE IN INCHES [MM].
2. DIE THICKNESS IS 0.004"
3. BOND PADS 1, 2 & 3 are 0.0059" [0.150] X 0.0039" [0.099].
4. BACKSIDE METALLIZATION: GOLD.
5. BOND PAD METALLIZATION: GOLD.
6. BACKSIDE METAL IS GROUND.
7. CONNECTION NOT REQUIRED FOR UNLABELED BOND PADS.
8. OVERALL DIE SIZE ± 0.002



### Pad Descriptions

Pad Number	Function	Description	Pad Schematic
1	LO	This pad is AC coupled and Matched to 50 Ohms.	LO ○ —  —
2	RF	This pad is AC coupled and Matched to 50 Ohms.	RF ○ —  —
3	IF	This pad is DC coupled and Matched to 50 Ohms.	IF ○ —   △   —
Die Bottom	GND	Die bottom must be connected to RF/DC ground	○ GND   —

### Assembly Diagram

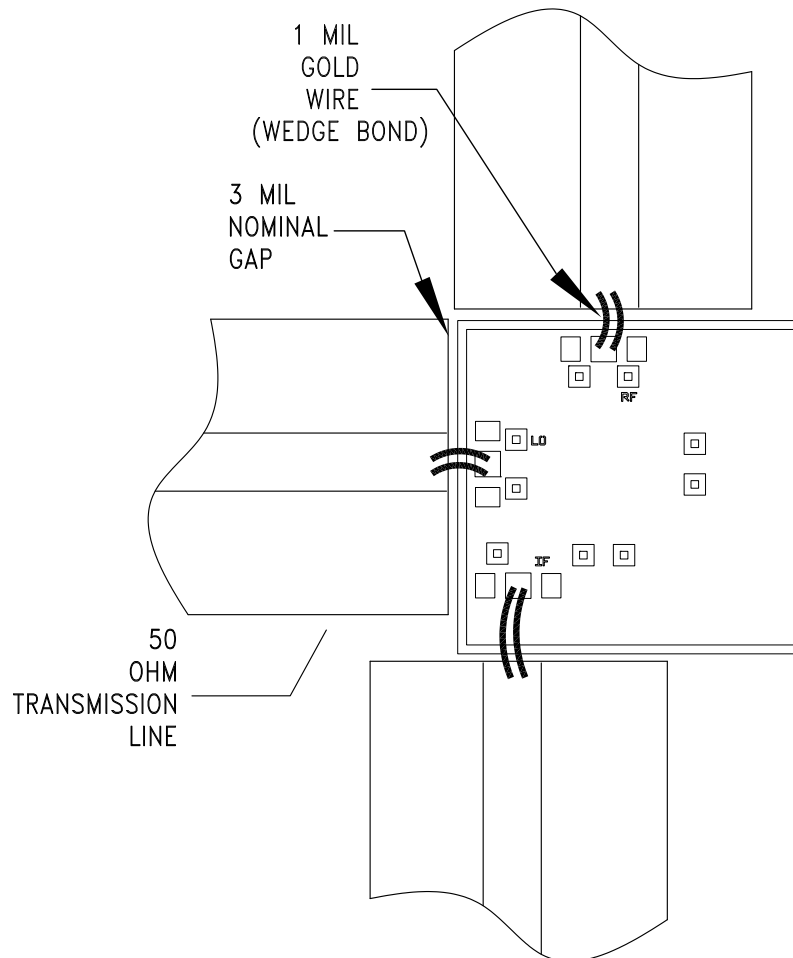

### Mounting & Bonding Techniques for Millimeterwave GaAs MMICs

The die should be attached directly to the ground plane eutectically or with conductive epoxy (see HMC general Handling, Mounting, Bonding Note).

50 Ohm Microstrip transmission lines on 0.127mm (5 mil) thick alumina thin film substrates are recommended for bringing RF to and from the chip (Figure 1). One way to accomplish this is to attach the 0.102mm (4 mil) thick die to a 0.150mm (6 mil) thick molybdenum heat spreader (moly-tab) which is then attached to the ground plane (Figure 2). Microstrip substrates should be located as close to the die as possible in order to minimize bond wire length. Typical die-to-substrate spacing is 0.076mm to 0.152 mm (3 to 6 mils).

#### Handling Precautions

Follow these precautions to avoid permanent damage.

**Storage:** All bare die are placed in either Waffle or Gel based ESD protective containers, and then sealed in an ESD protective bag for shipment. Once the sealed ESD protective bag has been opened, all die should be stored in a dry nitrogen environment.

**Cleanliness:** Handle the chips in a clean environment. DO NOT attempt to clean the chip using liquid cleaning systems.

**Static Sensitivity:** Follow ESD precautions to protect against  $> \pm 250V$  ESD strikes.

**Transients:** Suppress instrument and bias supply transients while bias is applied. Use shielded signal and bias cables to minimize inductive pick-up.

**General Handling:** Handle the chip along the edges with a vacuum collet or with a sharp pair of bent tweezers. The surface of the chip may have fragile air bridges and should not be touched with vacuum collet, tweezers, or fingers.

#### Mounting

The chip is back-metallized and can be die mounted with AuSn eutectic preforms or with electrically conductive epoxy. The mounting surface should be clean and flat.

**Eutectic Die Attach:** A 80/20 gold tin preform is recommended with a work surface temperature of 255 °C and a tool temperature of 265 °C. When hot 90/10 nitrogen/hydrogen gas is applied, tool tip temperature should be 290 °C. DO NOT expose the chip to a temperature greater than 320 °C for more than 20 seconds. No more than 3 seconds of scrubbing should be required for attachment.

**Epoxy Die Attach:** Apply a minimum amount of epoxy to the mounting surface so that a thin epoxy fillet is observed around the perimeter of the chip once it is placed into position. Cure epoxy per the manufacturer's schedule.

#### Wire Bonding

Ball or wedge bond with 0.025mm (1 mil) diameter pure gold wire. Thermosonic wirebonding with a nominal stage temperature of 150 °C and a ball bonding force of 40 to 50 grams or wedge bonding force of 18 to 22 grams is recommended. Use the minimum level of ultrasonic energy to achieve reliable wirebonds. Wirebonds should be started on the chip and terminated on the package or substrate. All bonds should be as short as possible  $< 0.31\text{mm}$  (12 mils).

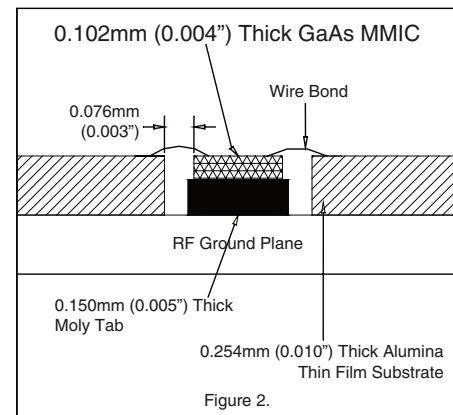
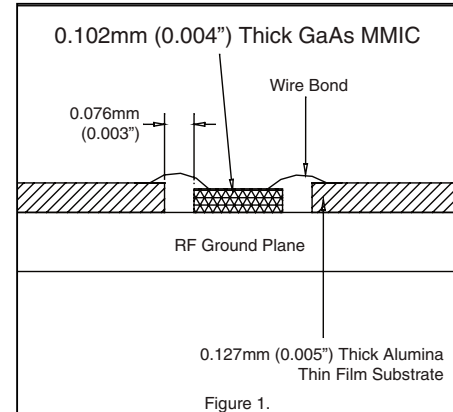



Компания «ЭлектроПласт» предлагает заключение долгосрочных отношений при поставках импортных электронных компонентов на взаимовыгодных условиях!

Наши преимущества:

- Оперативные поставки широкого спектра электронных компонентов отечественного и импортного производства напрямую от производителей и с крупнейших мировых складов;
- Поставка более 17-ти миллионов наименований электронных компонентов;
- Поставка сложных, дефицитных, либо снятых с производства позиций;
- Оперативные сроки поставки под заказ (от 5 рабочих дней);
- Экспресс доставка в любую точку России;
- Техническая поддержка проекта, помощь в подборе аналогов, поставка прототипов;
- Система менеджмента качества сертифицирована по Международному стандарту ISO 9001;
- Лицензия ФСБ на осуществление работ с использованием сведений, составляющих государственную тайну;
- Поставка специализированных компонентов (Xilinx, Altera, Analog Devices, Intersil, Interpoint, Microsemi, Aeroflex, Peregrine, Syfer, Eurofarad, Texas Instrument, Miteq, Cobham, E2V, MA-COM, Hittite, Mini-Circuits, General Dynamics и др.);

Помимо этого, одним из направлений компании «ЭлектроПласт» является направление «Источники питания». Мы предлагаем Вам помощь Конструкторского отдела:

- Подбор оптимального решения, техническое обоснование при выборе компонента;
- Подбор аналогов;
- Консультации по применению компонента;
- Поставка образцов и прототипов;
- Техническая поддержка проекта;
- Защита от снятия компонента с производства.



#### Как с нами связаться

**Телефон:** 8 (812) 309 58 32 (многоканальный)

**Факс:** 8 (812) 320-02-42

**Электронная почта:** [org@eplast1.ru](mailto:org@eplast1.ru)

**Адрес:** 198099, г. Санкт-Петербург, ул. Калинина, дом 2, корпус 4, литера А.