

Preliminary

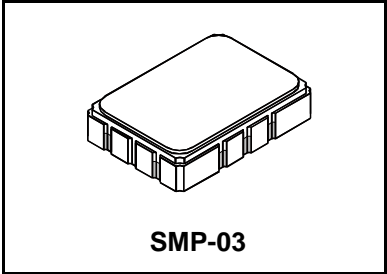

SF2076B

**464.00 MHz
SAW Filter**



- **Designed for 802.16 and WIMAX Receiver IF Application**
- **Low Insertion Loss**
- **5.0 X 7.0 mm or Single Ended Surface-Mount Case**
- **Differential Input and Output**
- **Complies with Directive 2002/95/EC (RoHS)**

Absolute Maximum Ratings

Rating	Value	Units
Maximum Incident Power in Passband	+13	dBm
Max. DC voltage between any 2 terminals	30	VDC
Storage Temperature Range	-40 to +85	°C
Suitable for lead-free soldering - Max Soldering Temperature	260°C for 30 s	

Electrical Characteristics

Characteristic	Sym	Notes	Min	Typ	Max	Units
Nominal Center Frequency	f_c	1		464.000		MHz
Insertion Loss				9.5	10.5	dB
Passband Variation; CF \pm 1.70 MHz				0.7	1.5	dB p-p
CF \pm 1.85 MHz					3	
Group Delay Variation; CF \pm 1.7 MHz				200	300	nsec
Triple Transit (reference to time domain main lobe peak)	Return Loss		10			dB
	after 1-2us		33	35.6		
	after 2-3us		10	11.8		
	after 3-4us		33	35.7		
	after >3us		40	43.2		
Rejection	DC to 264 MHz		30			dB
	264 to 368 MHz		40			
	368 to 424 MHz		50			
	424 to 460.65 MHz		40			
	467.35 to 664 MHz		40			
664 to 954 MHz		30				
Maximum Peak RF Input Power					13	dBm
Maximum RF Input Power Over Life					10	dBm
Life of Part					25	years
Temperature	Operating		-40		85	°C
	Storage		-40		85	
Case Style			SMP-03 7 x 5 mm Nominal Footprint			
Lid Symbolization (YY=year, WW=week, S=shift)			RFM SF2076B YYWWS			

- I. 200 ohm Matchingpage 2
- II. 200 ohm Matching Toko Inductorpage 5
- III. SMI 7035 Matchingpage 8

Notes:

1. Unless noted otherwise, all specifications apply over the operating temperature range with filter soldered to the specified demonstration board with impedance matching to 50 Ω and measured with 50 Ω network analyzer.
2. Rejection is measured as attenuation below the minimum IL point in the passband. Rejection in final user application is dependent on PCB layout and external impedance matching design. See Application Note No. 42 for details.
3. The design, manufacturing process, and specifications of this filter are subject to change.
4. Tape and Reel Standard ANSI / EIA 481.
5. US and international patents may apply.
6. RFM, stylized RFM logo, and RF Monolithics, Inc. are registered trademarks of RF Monolithics, Inc.
7. ©Copyright 1999, RF Monolithics Inc.
8. Electrostatic Sensitive Device. Observe precautions for handling.

I. Impedance Matching for 200 Ohm Differential Impedance: Coilcraft Inductors

(SAW Matched to 200 Ohms Balanced, 4:1 Transformers Account for 2dB of Loss)

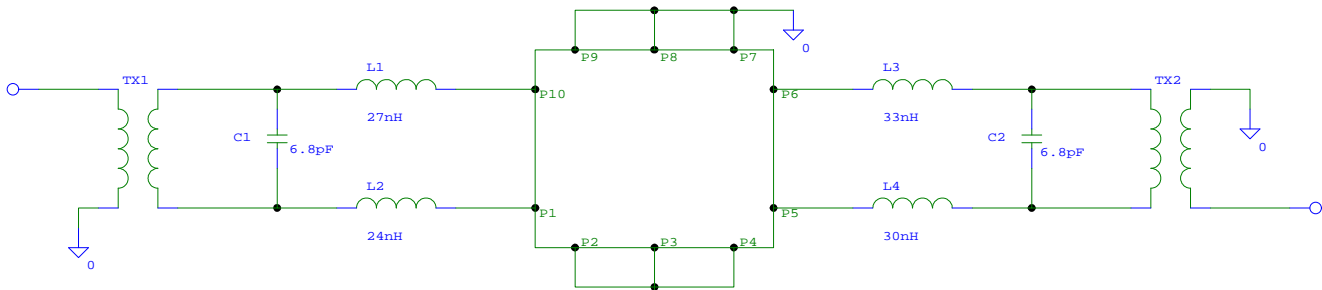

Part	Value	Manufacturer Part #	RFM Part #	Qty.
PCB	NA	CUSTOM BUILT FOR RFM	400-1608-001	1
L1	27 nH	Coilcraft 0603CS-27NXJB, 0603 size	NA	1
L2	24 nH	Coilcraft 0603CS-24NXJB, 0603 size	NA	1
L3	33 nH	Coilcraft 0603CS-33NXJB, 0603 size	NA	1
L4	30 nH	Coilcraft 0603CS-30NXJB, 0603 size	NA	1
C1, C3	6.8 pF	Murata GRM1885C1H6R8CZ01D	500-0621-068	2
C2	.5 pF	Murata GRM1885C1HR50CZ01D	NA	1
XFMR1, XFMR2	4:1 Ratio	Mini Circuits ADT4-1WT	500-0912-001	2
J1, J2	Female SMA	M/A Com 2052-0000-00	500-2048-001	2

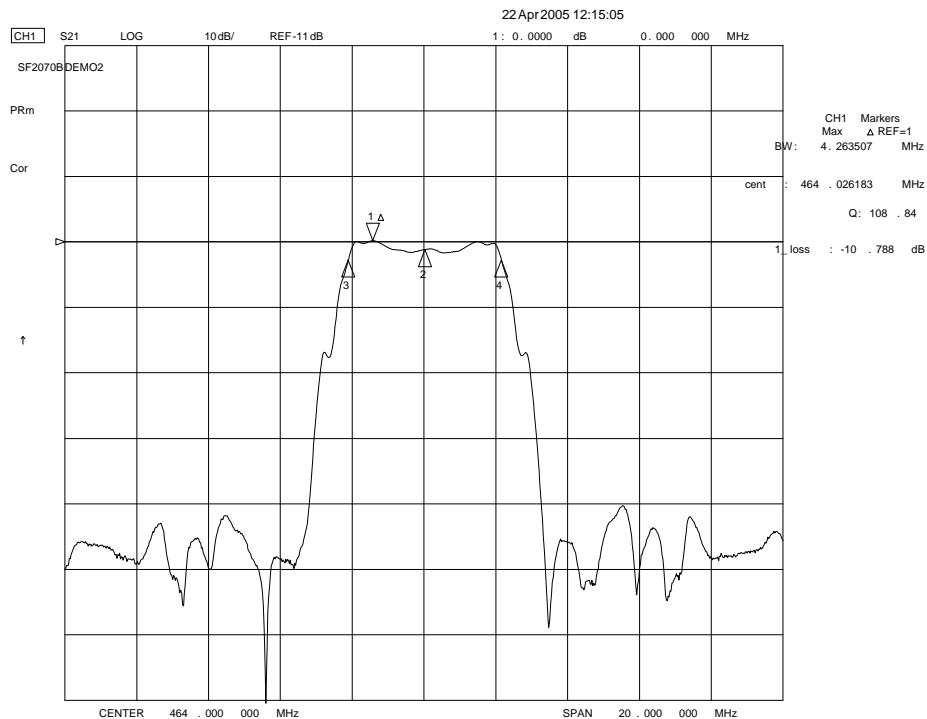

I. Impedance Matching for 200 Ohm Differential Impedance: Coilcraft Inductors

(SAW Matched to 200 Ohms Balanced, 4:1 Transformers Account for 2dB of Loss)

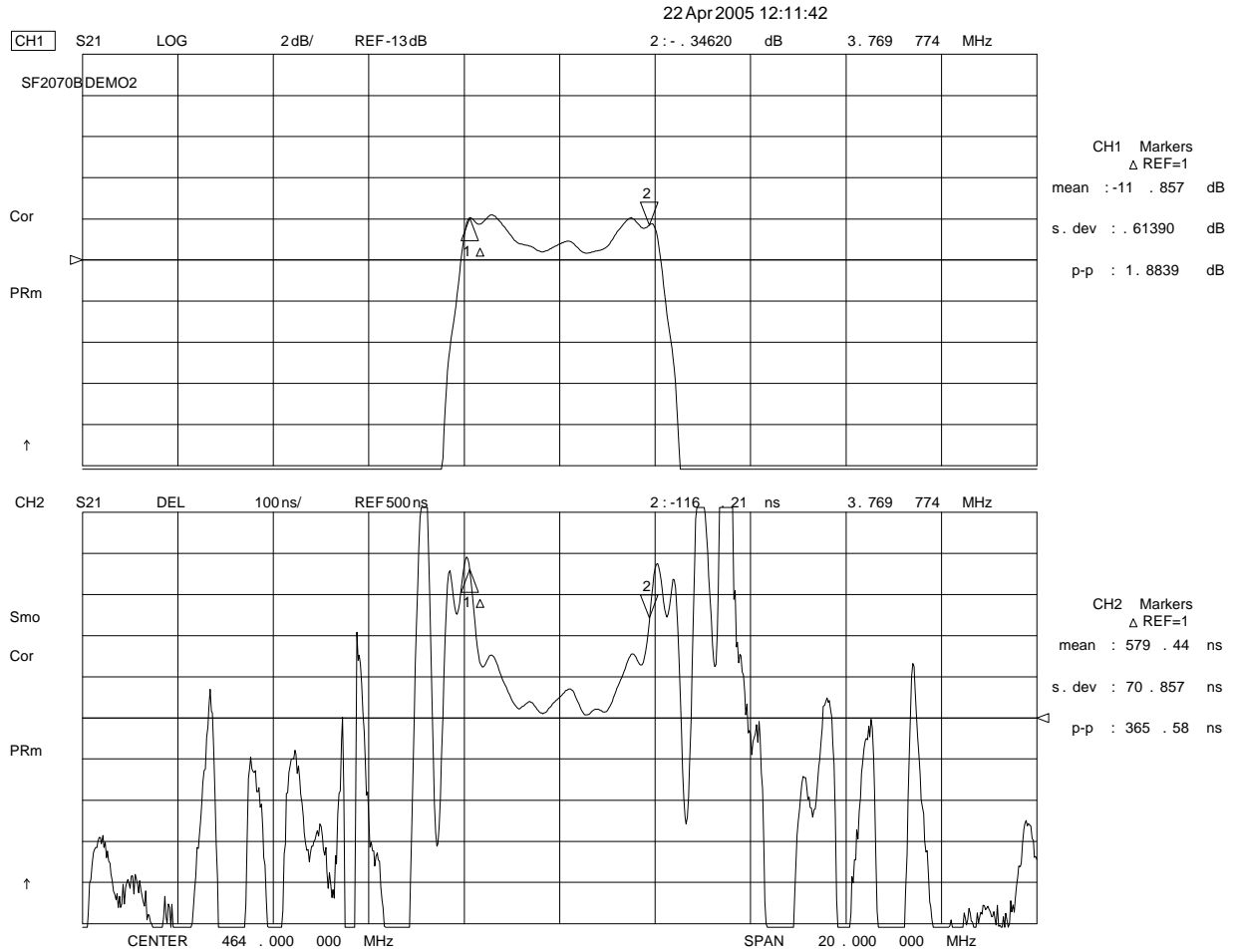

I. Impedance Matching for 200 Ohm Differential Impedance: Coilcraft Inductors

(SAW Matched to 200 Ohms Balanced, 4:1 Transformers Account for 2dB of Loss)

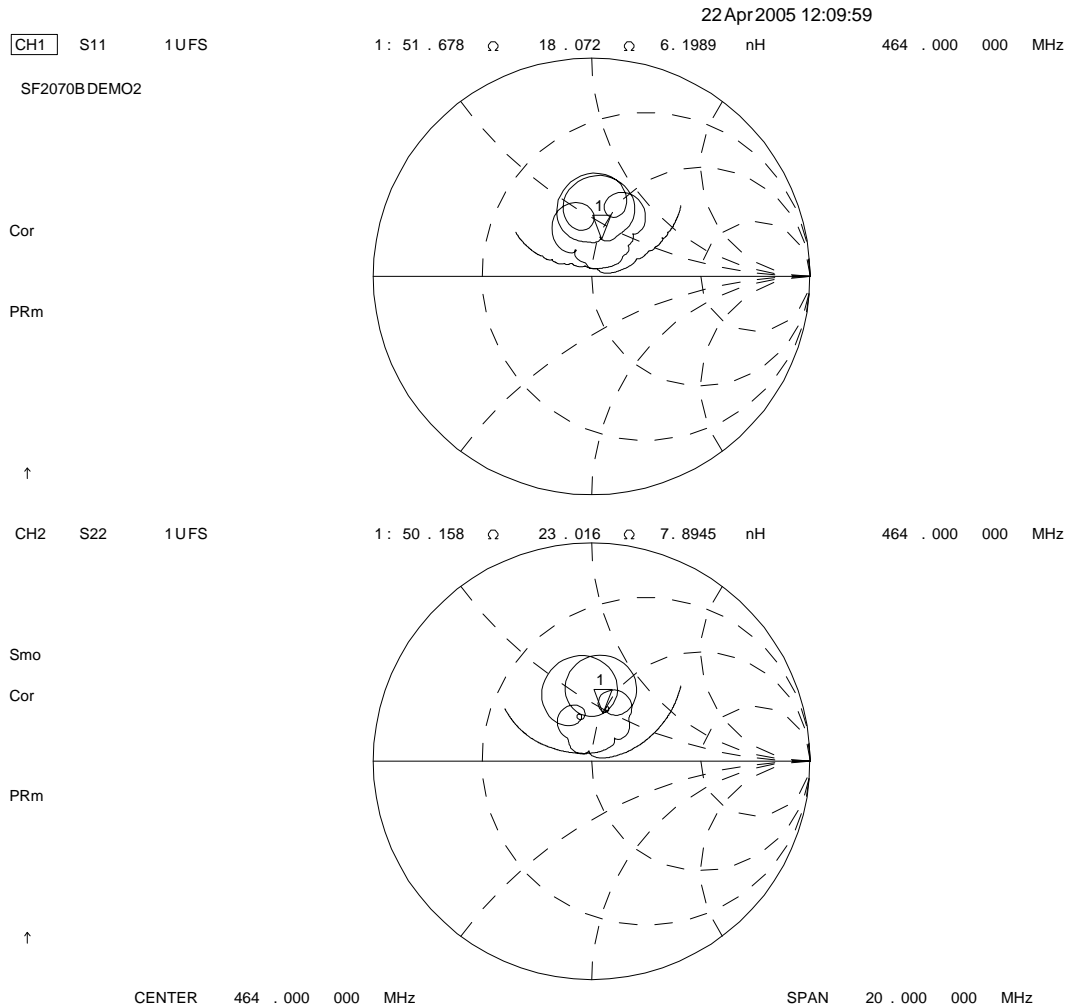

II. Impedance Matching: Toko Inductor

200 Ohm Differential Impedance (4:1 Transformers Account for 2dB of Loss)

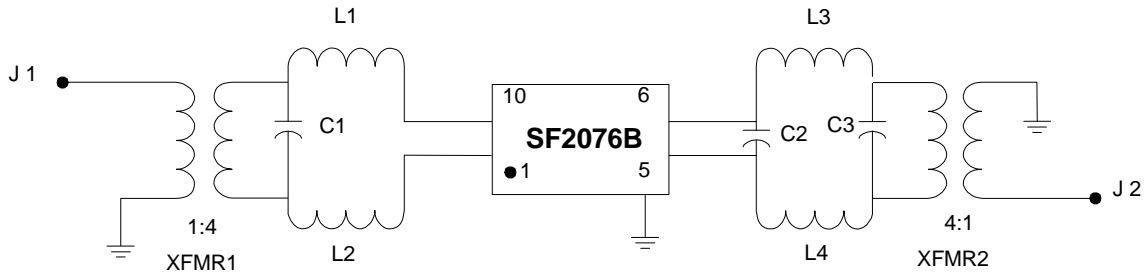

All Other Pins Ground

Part	Value	Manufactureer Part #	RFM Part #	Qty.
PCB	NA	CUSTOM BUILT FOR RFM	400-1608-001	1
L2-L4	27 nH	TOKO LL 1608-FSL27NJ	NA	4
C1, C3	6.8 pF	Murata GRM1885C1H6R8CZ01D	500-0621-068	2
C2	.5 pF	Murata GRM1885C1HR50CZ01D	NA	1
XFMR1, XFMR2	4:1 Ratio	Mini Circuits ADT4-1WT	500-0912-001	2
J1, J2	Female SMA	M/A Com 2052-0000-00	500-2048-001	2

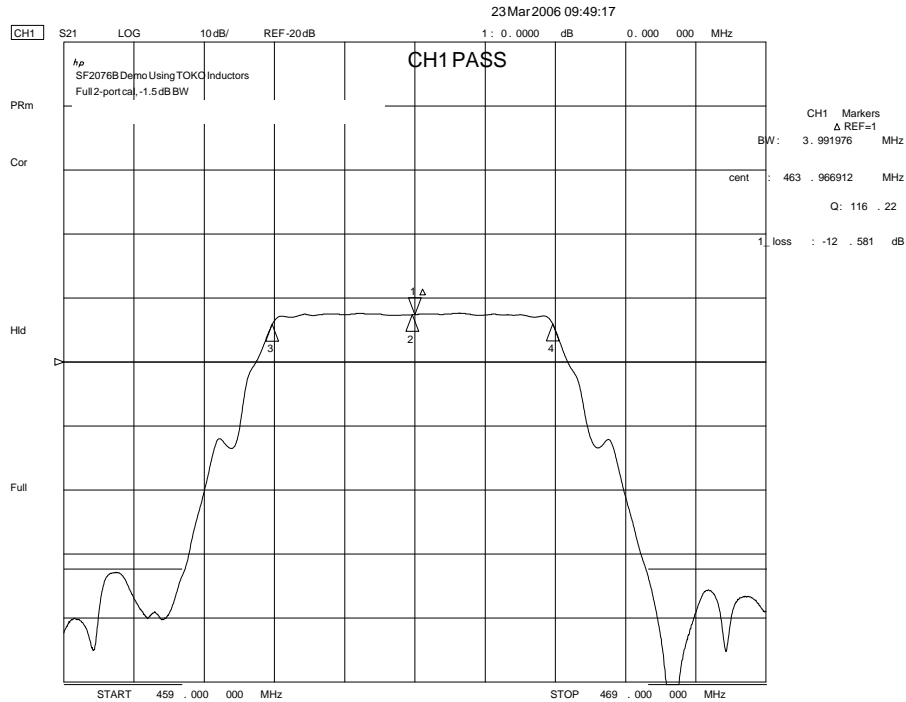

II. Impedance Matching: Toko Inductor 200 Ohm Differential Impedance (4:1 Transformers Account for 2dB of Loss)

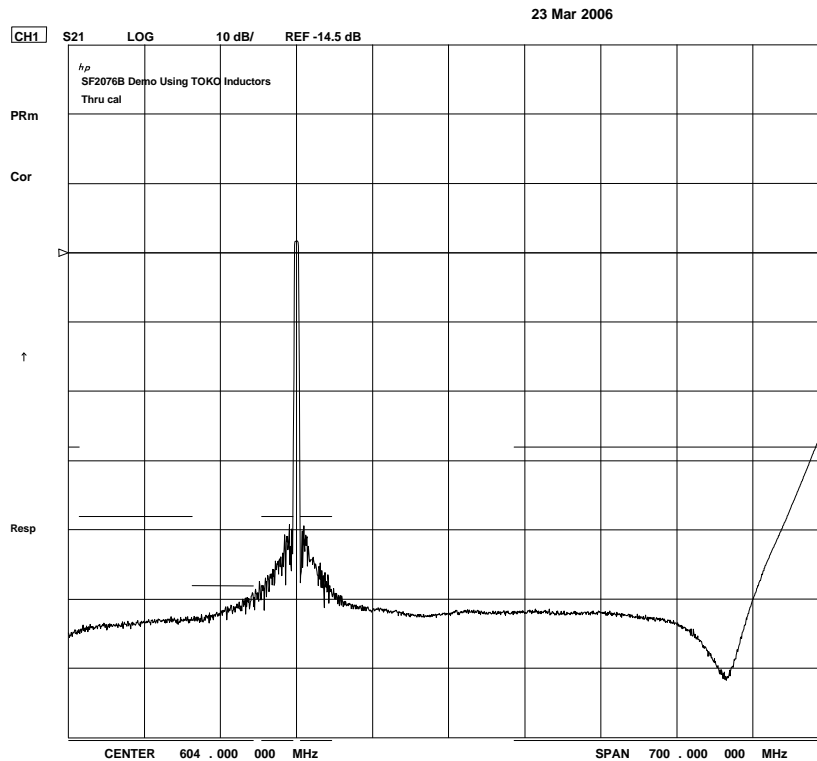
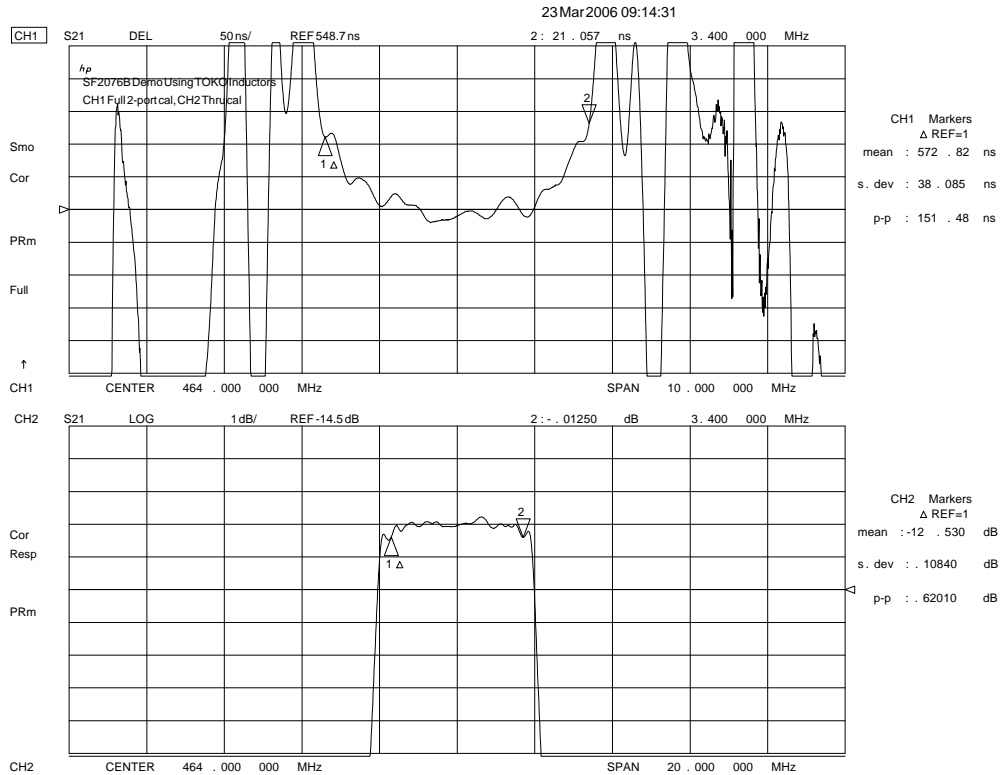

II. Impedance Matching: Toko Inductor 200 Ohm Differential Impedance (4:1 Transformers Account for 2dB of Loss)

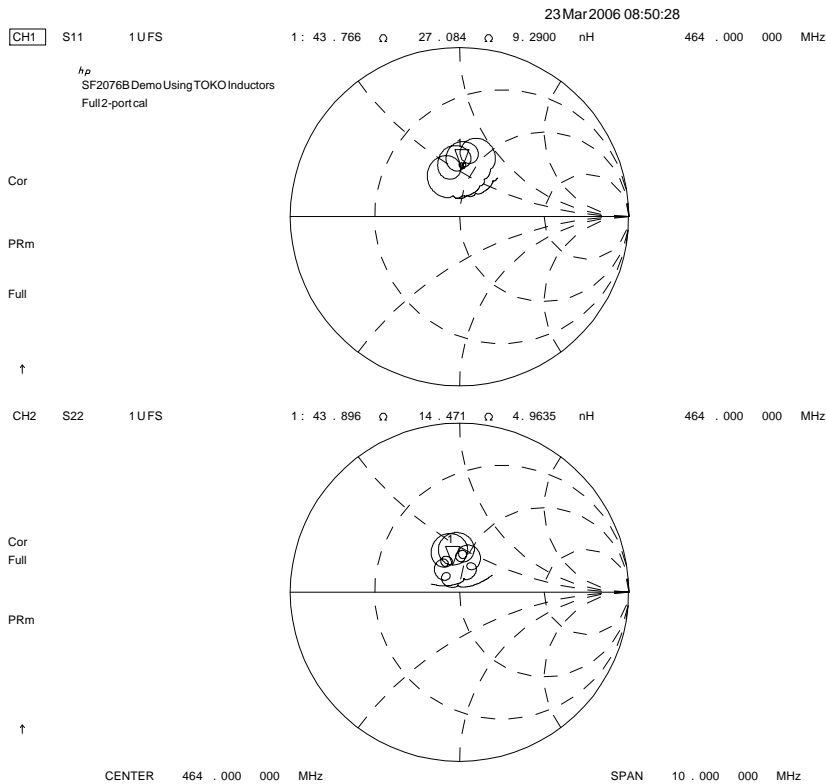
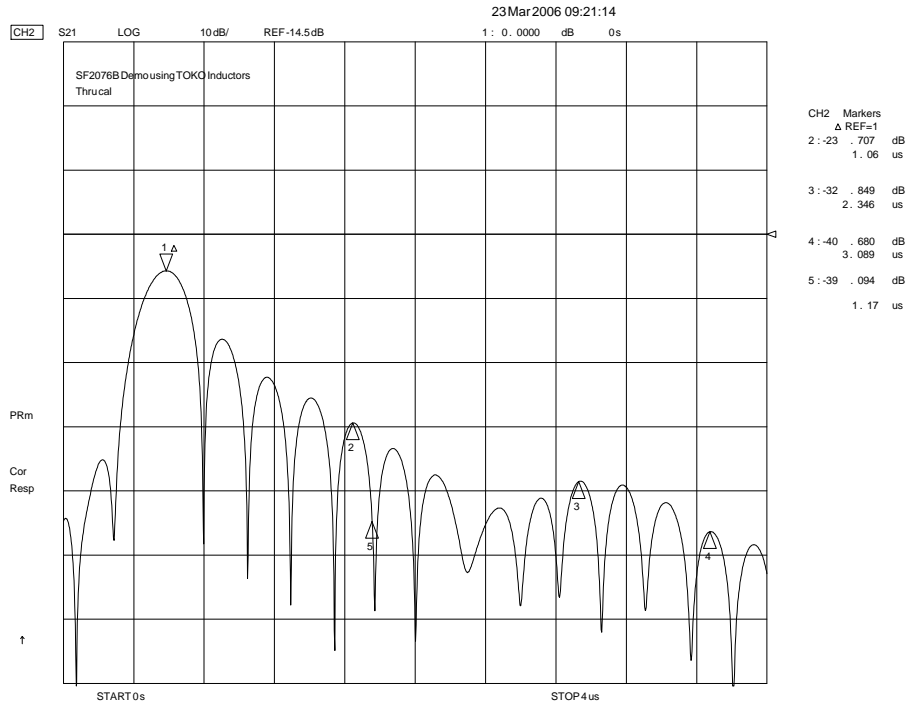

III. Impedance Matching on SMI Radio Board: SMI7035

(200 Ohms Differential)

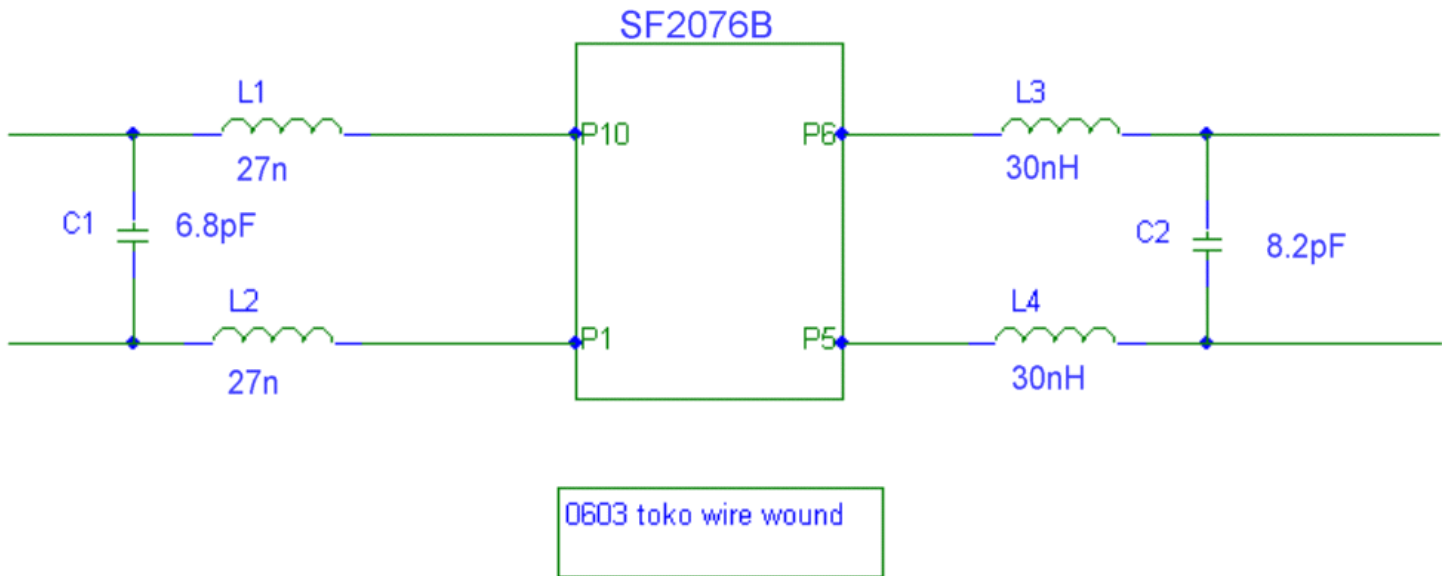

III. Impedance Matching on SMI Radio Board: SMI7035

(SAW Matched to 200 Ohms Balanced)

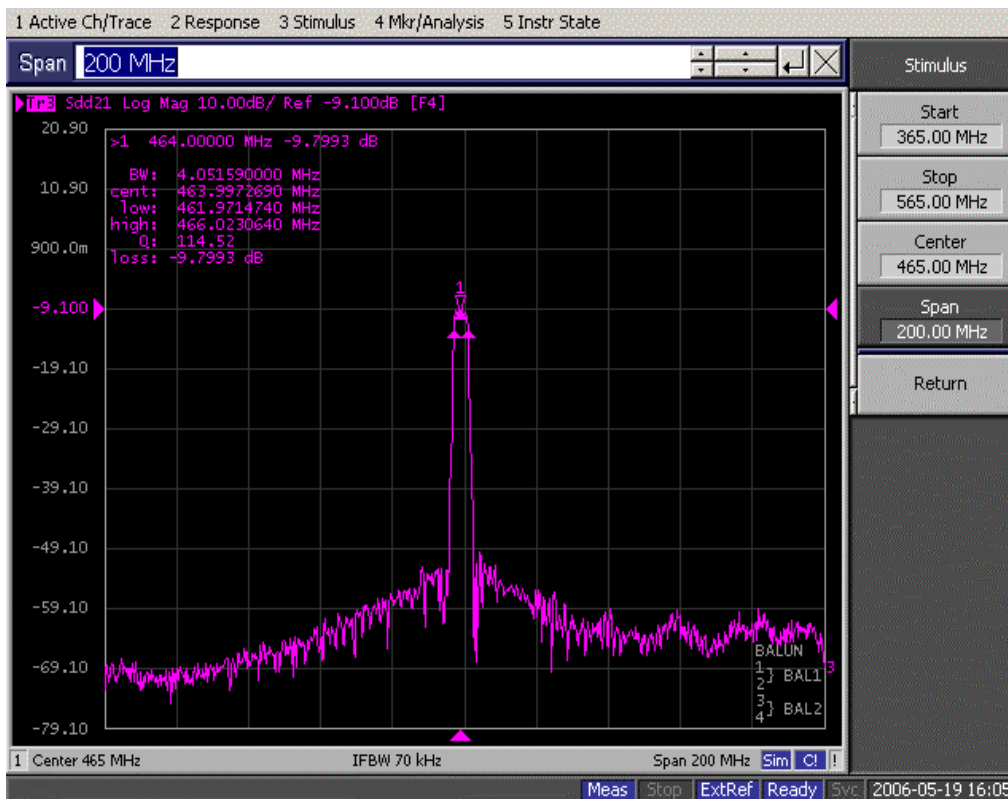
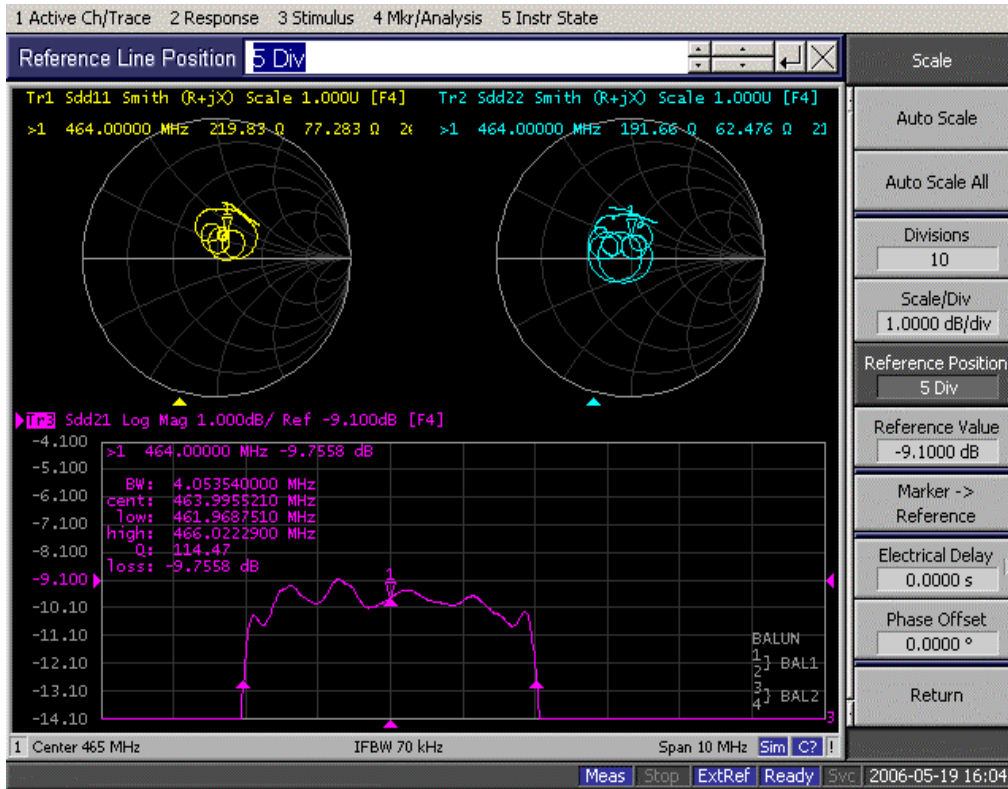

SMP-03 Case

10-Terminal Ceramic Surface-Mount Case 7 x 5 mm Nominal Footprint

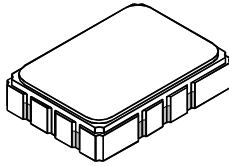

Recommended PCB Footprint

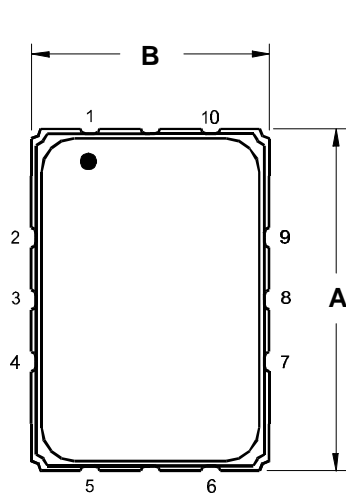
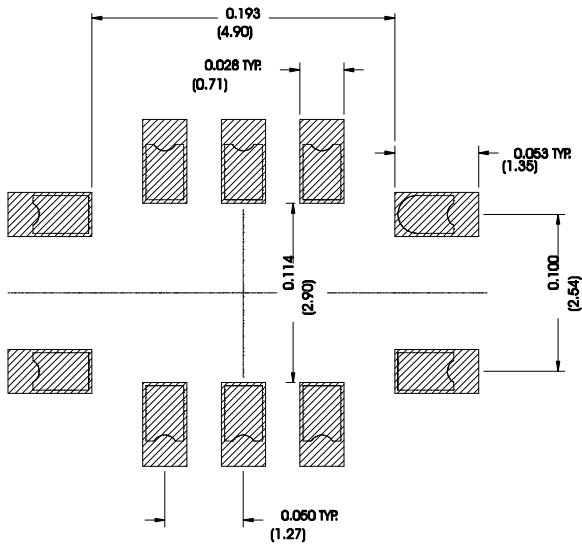

TOP VIEW

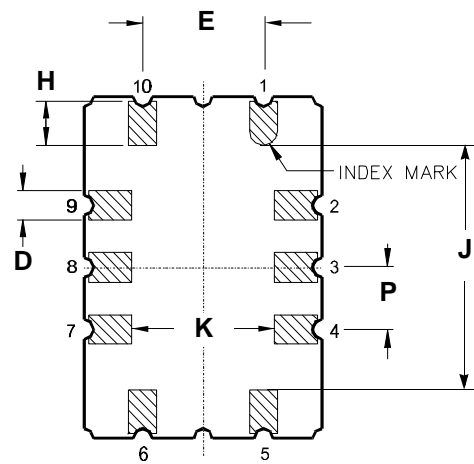
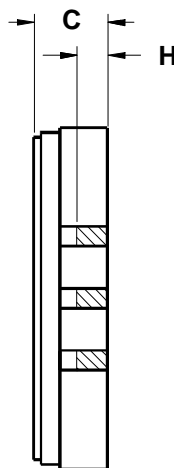

BOTTOM VIEW

Case Dimensions						
Dimension	mm			Inches		
	Min	Nom	Max	Min	Nom	Max
A	6.80	7.00	7.20	0.268	0.276	0.283
B	4.80	5.00	5.20	0.189	0.197	0.205
C	1.50	1.65	2.00	0.059	0.065	0.079
D	.47	0.60	.73	0.019	0.024	0.029
E	2.41	2.54	2.67	0.095	0.100	0.105
H	0.87	1.0	1.13	0.034	0.039	0.044
J	4.87	5.00	5.13	0.192	0.197	0.202
K	2.87	3.00	3.13	0.113	0.118	0.123
P	1.14	1.27	1.40	0.045	0.050	0.055

Materials	
Solder Pad Termination	Au plating 30 - 60 μinches (76.2-152 μm) over 80-200 μinches (203-508 μm) Ni.
Lid	Fe-Ni-Co Alloy Electroless Nickel Plate (8-11% Phosphorus) 100-200 μinches Thick
Body	Al ₂ O ₃ Ceramic
Pb Free	

Electrical Connections		
Connection		Terminals
Port 1	Input or Return	10
	Return or Input	1
Port 2	Output or Return	5
	Return or Output	6
Ground		All others
Single Ended Operation		Return is ground
Differential Operation		Return is hot

Tape and Reel Specifications

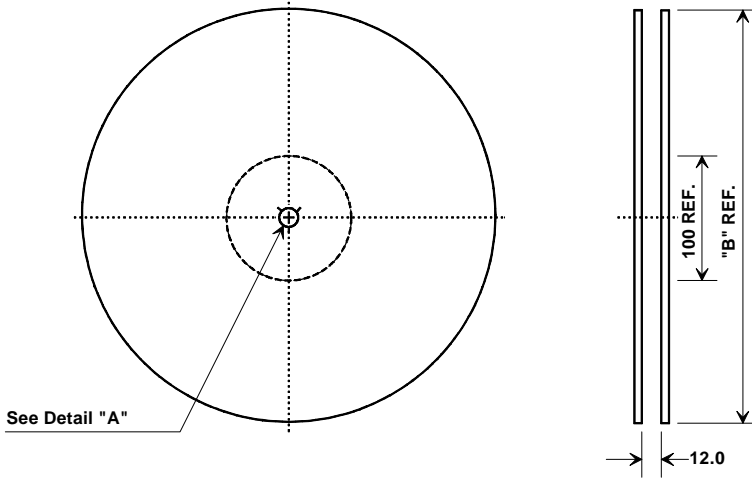

"B" Nominal Size		Quantity Per Reel
Inches	millimeters	
7	178	500
13	330	2000

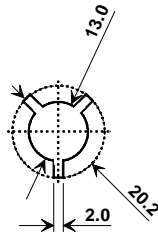

COMPONENT ORIENTATION and DIMENSIONS

Carrier Tape Dimensions		Tolerance
Ao	5.5 mm	± 0.1mm
Bo	7.5 mm	± 0.1mm
Ko	2.0 mm	± 0.1mm
Pitch	8.0 mm	± 0.1mm
W	16.0 mm	± 0.2mm

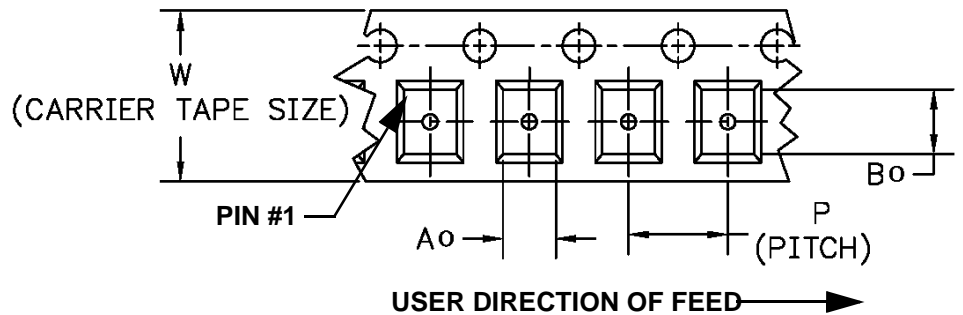
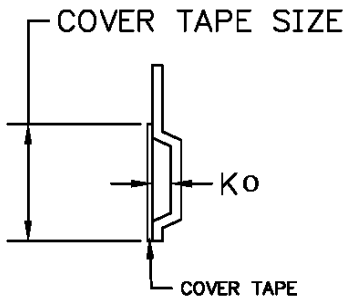



Компания «ЭлектроПласт» предлагает заключение долгосрочных отношений при поставках импортных электронных компонентов на взаимовыгодных условиях!

Наши преимущества:

- Оперативные поставки широкого спектра электронных компонентов отечественного и импортного производства напрямую от производителей и с крупнейших мировых складов;
- Поставка более 17-ти миллионов наименований электронных компонентов;
- Поставка сложных, дефицитных, либо снятых с производства позиций;
- Оперативные сроки поставки под заказ (от 5 рабочих дней);
- Экспресс доставка в любую точку России;
- Техническая поддержка проекта, помощь в подборе аналогов, поставка прототипов;
- Система менеджмента качества сертифицирована по Международному стандарту ISO 9001;
- Лицензия ФСБ на осуществление работ с использованием сведений, составляющих государственную тайну;
- Поставка специализированных компонентов (Xilinx, Altera, Analog Devices, Intersil, Interpoint, Microsemi, Aeroflex, Peregrine, Syfer, Eurofarad, Texas Instrument, Miteq, Cobham, E2V, MA-COM, Hittite, Mini-Circuits, General Dynamics и др.);

Помимо этого, одним из направлений компании «ЭлектроПласт» является направление «Источники питания». Мы предлагаем Вам помощь Конструкторского отдела:

- Подбор оптимального решения, техническое обоснование при выборе компонента;
- Подбор аналогов;
- Консультации по применению компонента;
- Поставка образцов и прототипов;
- Техническая поддержка проекта;
- Защита от снятия компонента с производства.



Как с нами связаться

Телефон: 8 (812) 309 58 32 (многоканальный)

Факс: 8 (812) 320-02-42

Электронная почта: org@eplast1.ru

Адрес: 198099, г. Санкт-Петербург, ул. Калинина, дом 2, корпус 4, литера А.