

Specification

SSC-SZR05A0A

SZR05A0A

Description

The Z-Power series is designed for high current operation and high flux output applications.

It incorporates state of the art SMD design and low thermal resistant material.

The Z Power LED is ideal light sources for general illumination applications, custom designed solutions, large backlights and high performance torches.

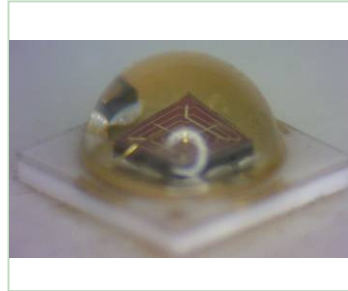

SZR05A0A

Features

- Super high Flux output and high Luminance
- Designed for high current operation
- SMT solderable
- Lead Free product
- RoHS compliant

Applications

- General Torch
- Architectural lighting
- Projector light source
- Traffic signals
- Task lighting
- Decorative / Pathway lighting
- Remote / Solar powered lighting
- Automotive interior / exterior lighting
- Automotive signal / forward lighting

* The appearance and specifications of the product can be changed for improvement without notice.

[Contents]

- 1. Full code of Z5 Series**
- 2. Outline dimensions**
- 3. Characteristics of SZR05A0A (Red)**
- 4. Characteristic diagrams**
- 5. Bin Code Description**
- 6. Labeling**
- 7. Packing**
- 8. Recommended solder pad**
- 9. Soldering**
- 10. Precaution for use**
- 11. Handling of Silicone Resin LEDs**

1. Full code of Z5 series

Full code form : $X_1 X_2 X_3 X_4 X_5 X_6 X_7 X_8$

1. Part Number

X_1	Company
-------	---------

X_2	Z-Power LED series number
-------	---------------------------

$X_3 X_4$	Color Specification
R0	Red

X_5	PKG Series
5	Z5 series

X_6	Lens type
-------	-----------

X_7	PCB Type
-------	----------

2. Internal Number

X_8	Revision No.
-------	--------------

2. Outline dimensions

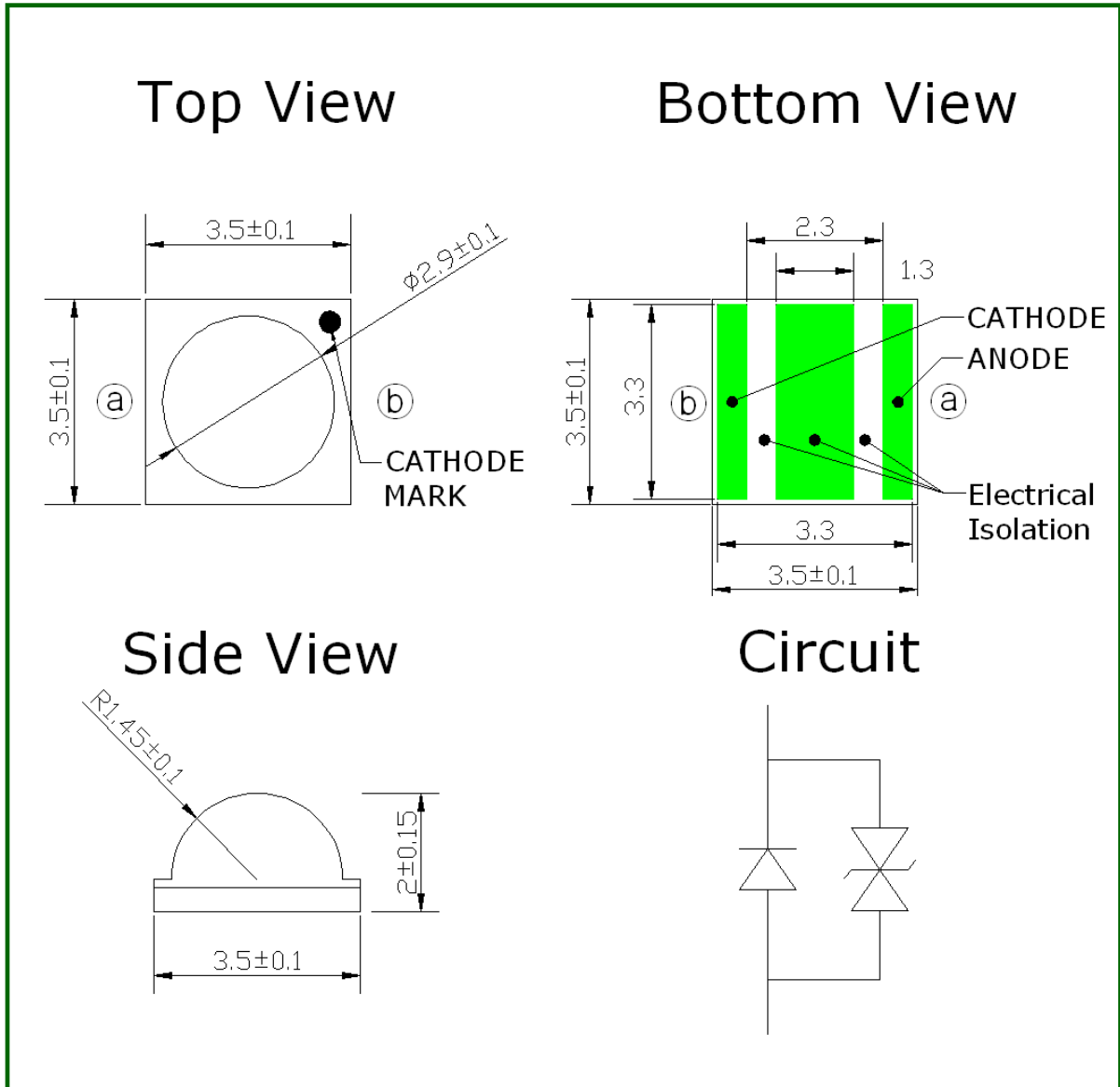

Notes :

- [1] All dimensions are in millimeters.
- [2] Scale : none
- [3] Undefined tolerance is ± 0.1 mm

3. Characteristics of SZR05A0A (Red)

Red

1-1 Electro-Optical characteristics at 350mA

(Ta=25°C, RH30%)

Parameter	Symbol	Value			Unit
		Min	Typ	Max	
Luminous Flux [1]	Φ_V [2]	41.5	55	60	lm
	Φ_V (Tj=100°C)	-	26	-	
Dominant Wavelength[3]	λ_D	618	625	632	nm
Forward Voltage [4]	V_F	-	2.4	3.0	V
Thermal resistance (J to S)	$R_{\theta_{J-S}}$	7.0			K /W
View Angle	$2\theta \frac{1}{2}$	123			deg.

1-2 Absolute Maximum Ratings

Parameter	Symbol	Value	Unit
Forward Current	I_F	700	mA
Reverse Voltage	V_r	5	V
Power Dissipation	P_d	2.3	W
Junction Temperature	T_j	125(@ $I_F \leq 700mA$)	°C
Operating Temperature	T_{opr}	-40 ~ +100	°C
Storage Temperature	T_{stg}	-40 ~ +100	°C
ESD Sensitivity(HBM) [6]	-	2	kV

*Notes :

- [1] SSC maintains a tolerance of $\pm 7\%$ on flux and power measurements.
- [2] Φ_V is the total luminous flux output as measured with an integrating sphere.
- [3] Correlated Color Temperature is derived from the CIE 1931 Chromaticity diagram.
Color coordinate : ± 0.005 , CCT $\pm 5\%$ tolerance.
- [4] Tolerance is $\pm 0.06V$ on forward voltage measurements
- [5] A zener diode is included to protect the product from ESD.
- [6] Tolerance is ± 2.0 on CRI measurements

4. Characteristic diagrams

Color Spectrum

(IF=350mA, Ta=25°C, RH30%)

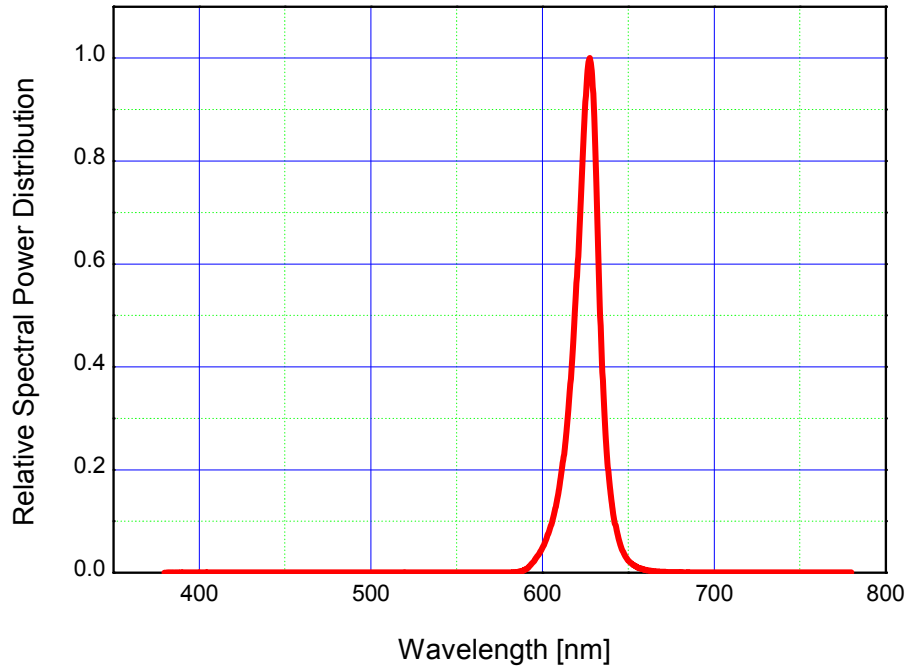

Forward Current Characteristics

Forward Voltage vs. Forward Current, Ta=25℃

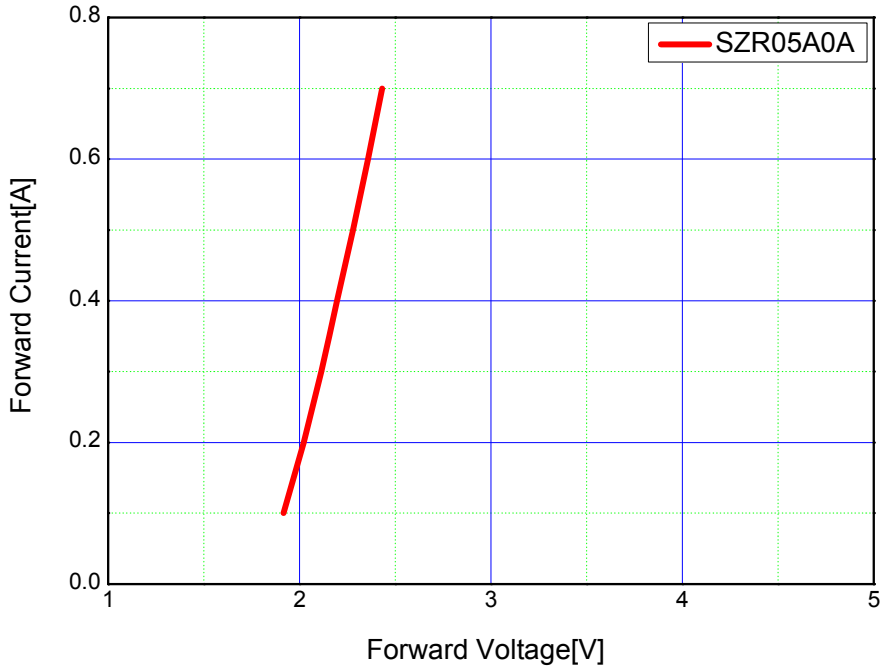

Forward Current vs. Normalized Relative Luminous Flux, Ta=25℃

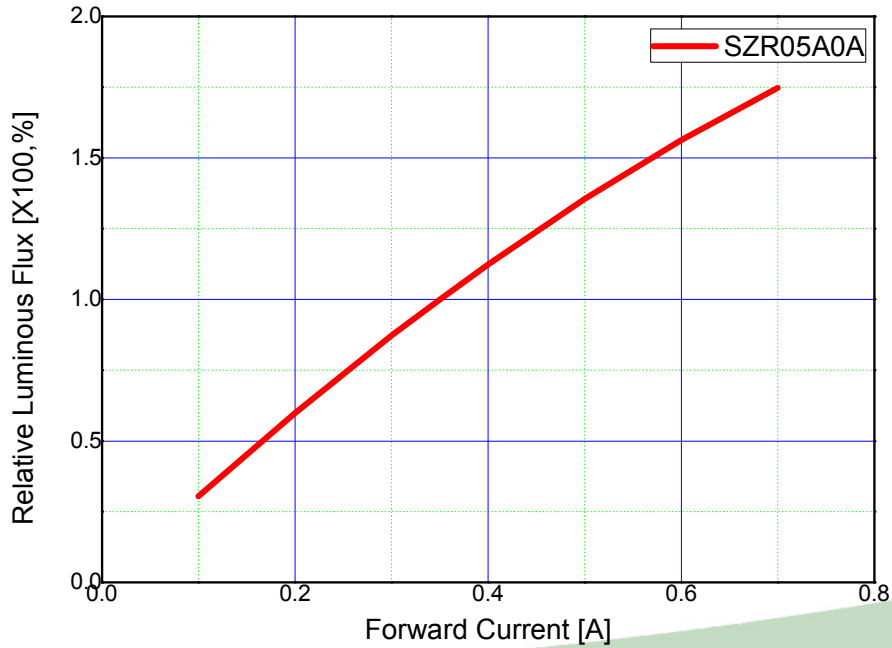

Forward Current vs Wavelength Shift, Ta=25℃

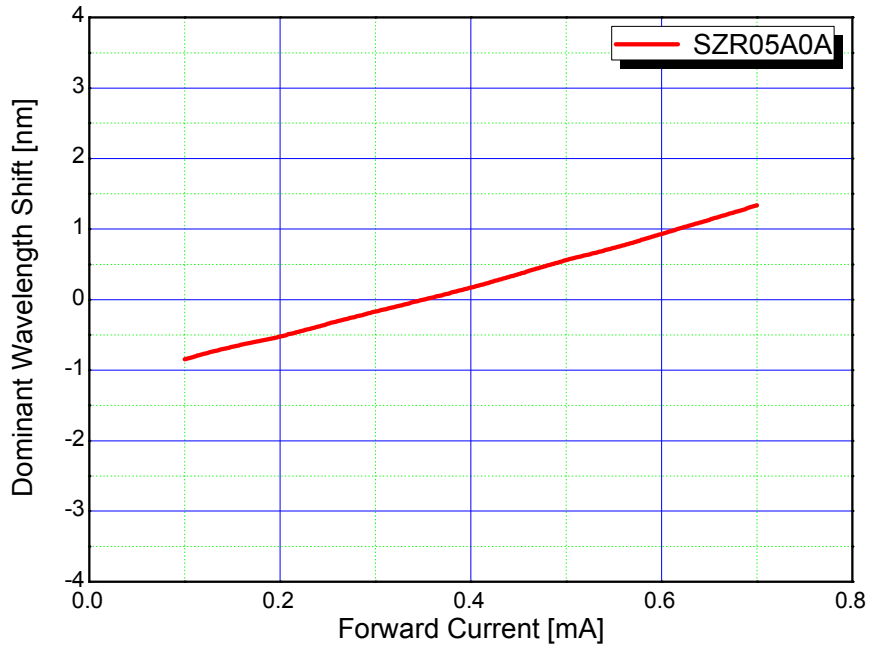

Junction Temperature Characteristics

Junction Temperature vs. Relative Light Output at IF=350mA

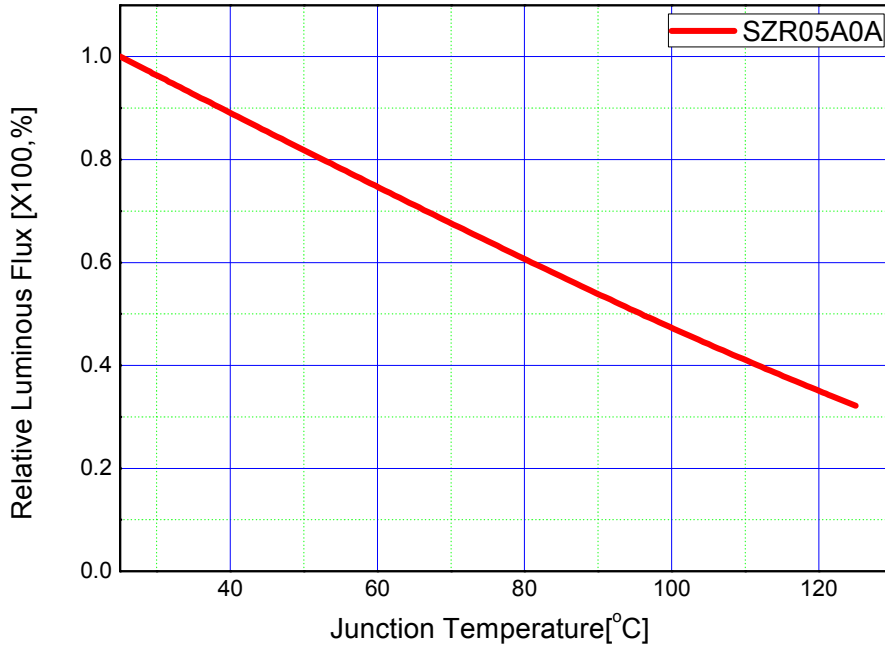

Junction Temperature vs. Forward Voltage at IF=350mA

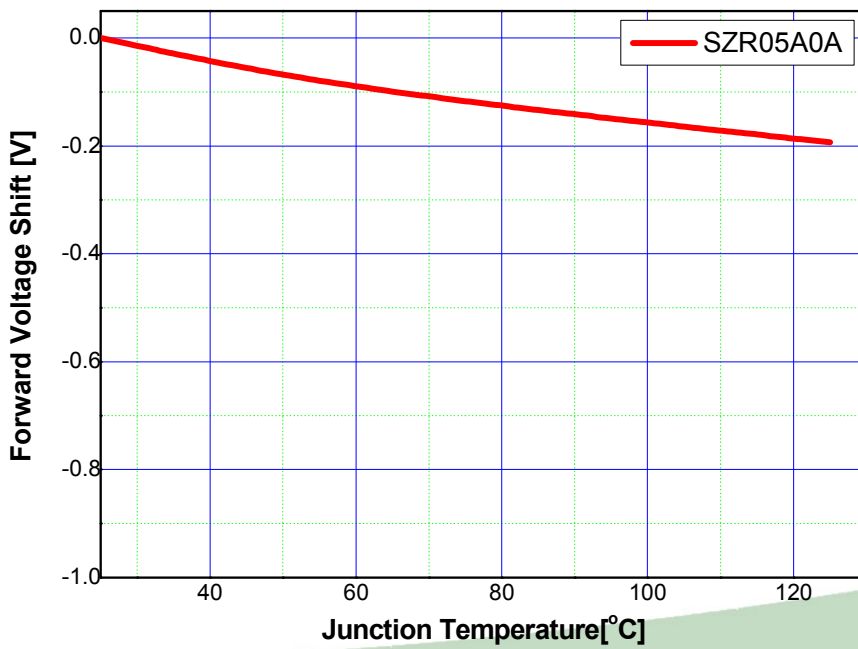

Junction Temperature Characteristics

Junction Temperature vs. Dominant Wavelength at IF=350mA

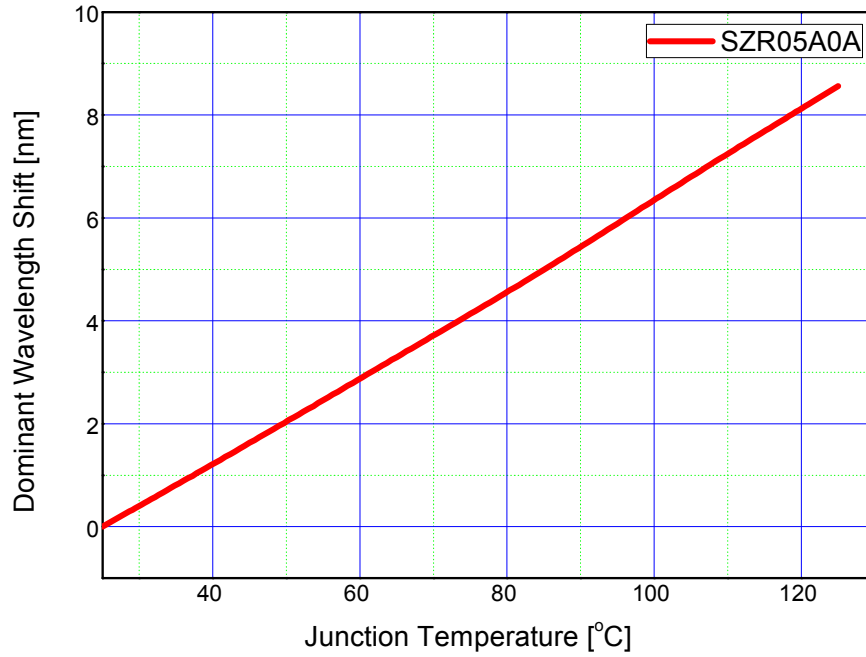

Characteristic diagrams

Ambient Temperature vs. Allowable Forward Current (Tjmax = 125°C, @0.7A)

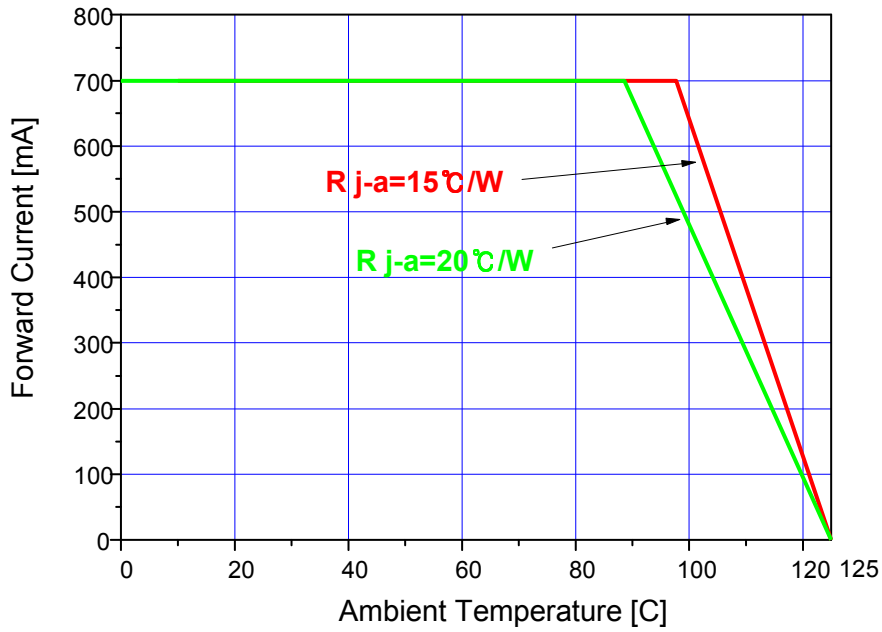

Radiation pattern at 350mA

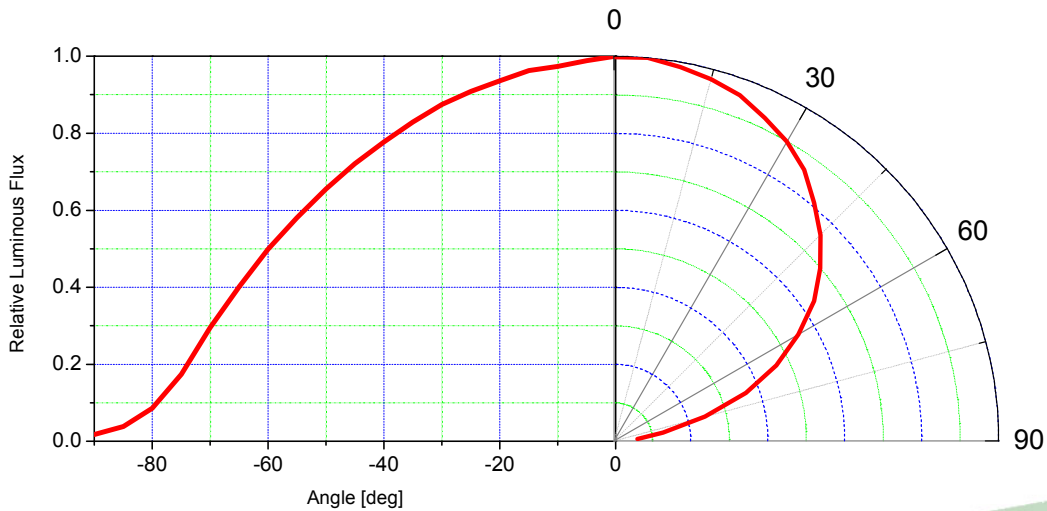





5. Bin Code Description

Bin Code		
Radiant Power (mW) @ $I_F = 350\text{mA}$	Dominant Wavelength (nm) @ $I_F = 350\text{mA}$	Forward Voltage (V) @ $I_F = 350\text{mA}$
R	RR1	E

Radiant Power (mW) @ $I_F = 350\text{mA}$			Dominant Wavelength (nm) @ $I_F = 350\text{mA}$			Forward Voltage (V) @ $I_F = 350\text{mA}$		
Bin Code	Min.	Max.	Bin Code	Min.	Max.	Bin Code	Min.	Max.
R	41.5	54.0	RR1	618	625	D	2.00	2.25
S	54.0	70.0	RR2	625	632	E	2.25	2.50
						F	2.50	2.75

6. Labeling

Rank :	 X ₁₀ X ₁₁ X ₁₂ X ₁₃
Quantity : 1000	
Lot No : #####	
SSC PART NUMBER : SZR05A0A	
 SZR05A0A	

Full code form

X₁X₂X₃X₄X₅X₆X₇X₈

- X₁ : Company
- X₂ : Z-Power LED series number
- X₃ X₄ : Color Specification
- X₅ : PKG Series
- X₆ : Lens Type
- X₇ : PCB Type
- X₈ : Revision No.

Rank

X₁₀X₁₁X₁₂X₁₃

- X₁₀ : Luminous Flux : LF [lm]
- X₁₁X₁₂ : Dominant Wavelength [nm]
- X₁₃ : Forward Voltage : V_F [V]

Lot No

#1#2#3#4#5#6 - #7#8#9#10 - #11#12#13

- | | |
|---|---|
| - # ₁ # ₂ : Year | - # ₇ # ₈ # ₉ # ₁₀ : Mass order |
| - # ₃ # ₄ : Month | - # ₁₁ # ₁₂ # ₁₃ : Tray No. |
| - # ₅ # ₆ : Day | |

7. Packing

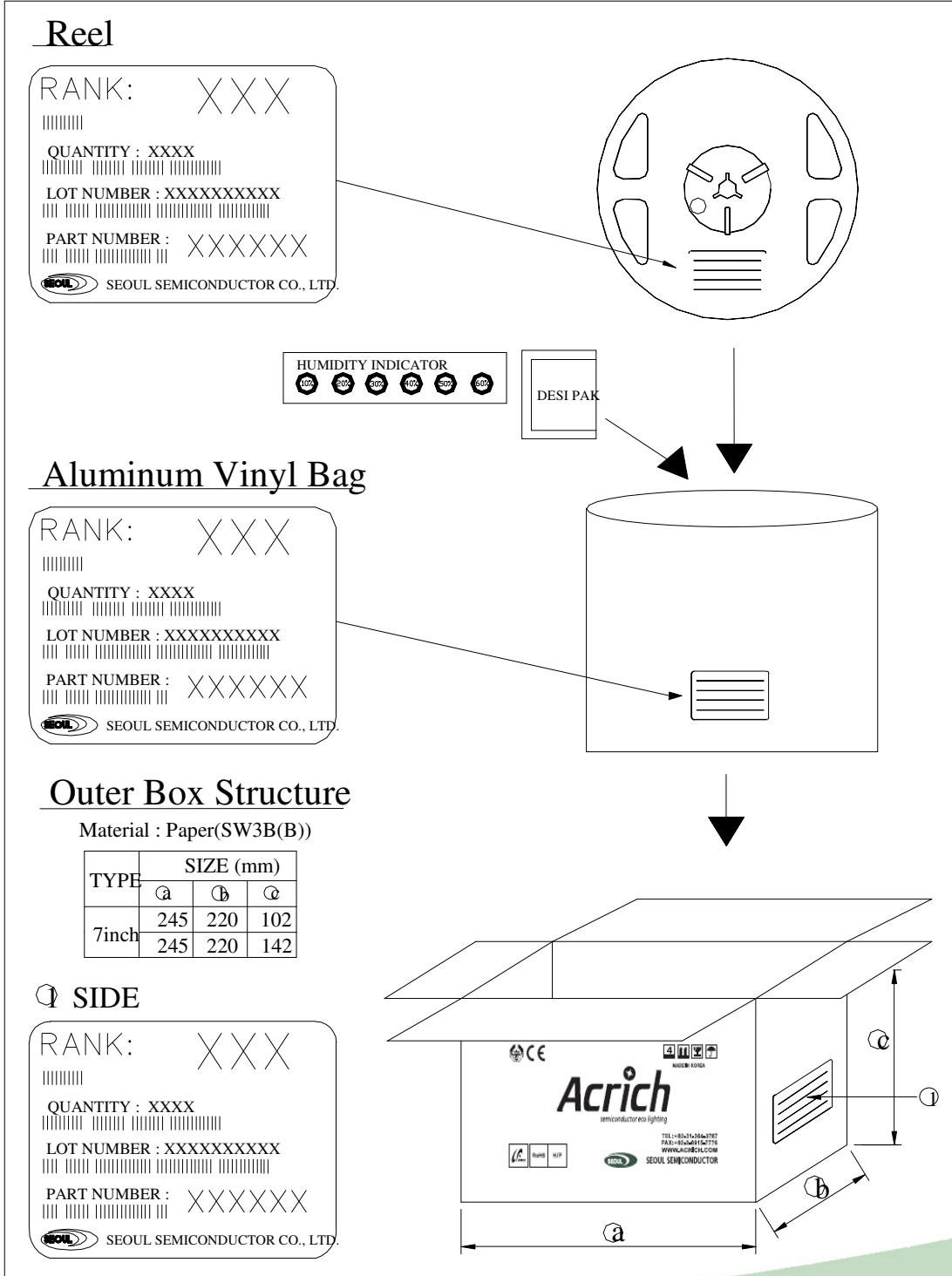

8. Recommended solder pad

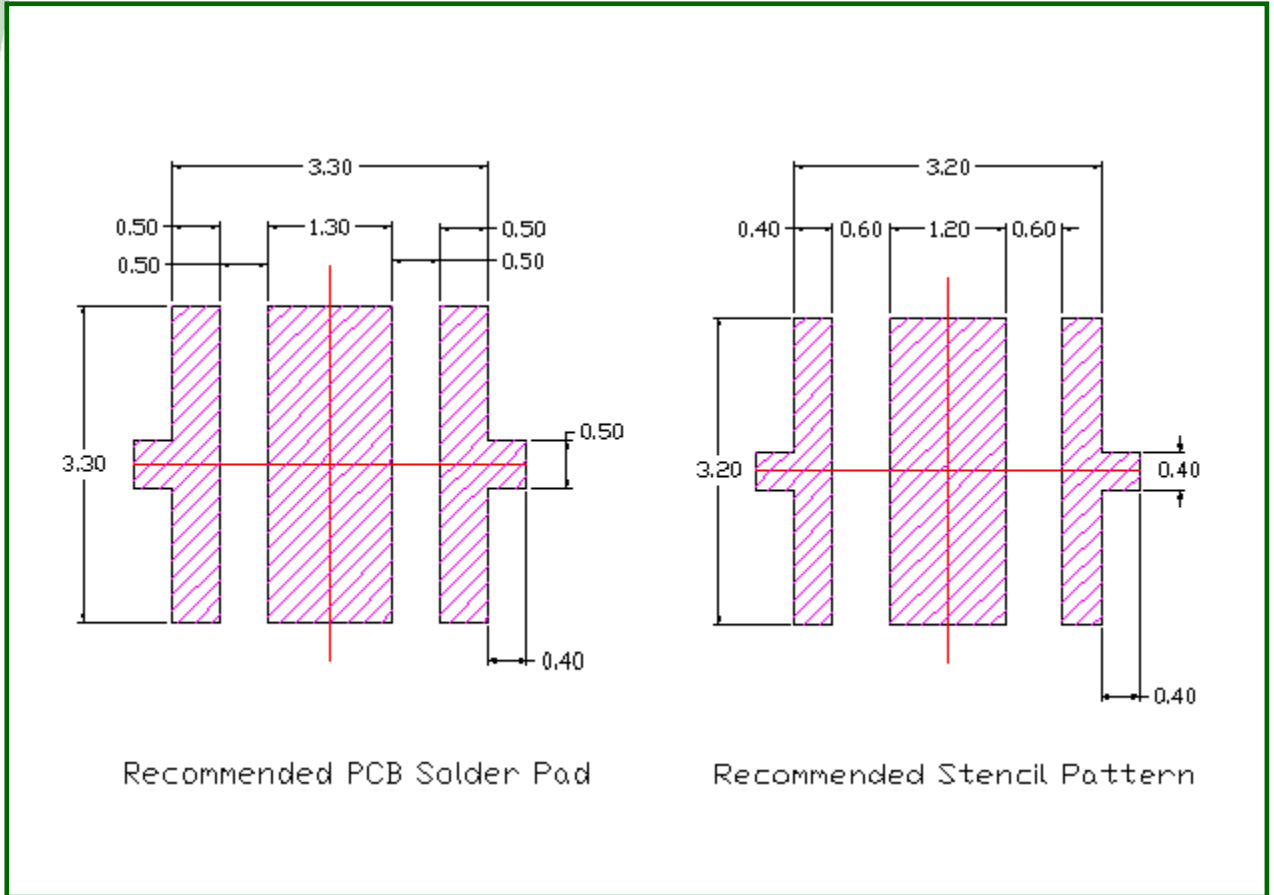

Recommended PCB Solder Pad

Recommended Stencil Pattern

Notes :

- [1] All dimensions are in millimeters.
- [2] Scale : none
- [3] This drawing without tolerances are for reference only
- [4] Undefined tolerance is $\pm 0.1\text{mm}$

9. Soldering

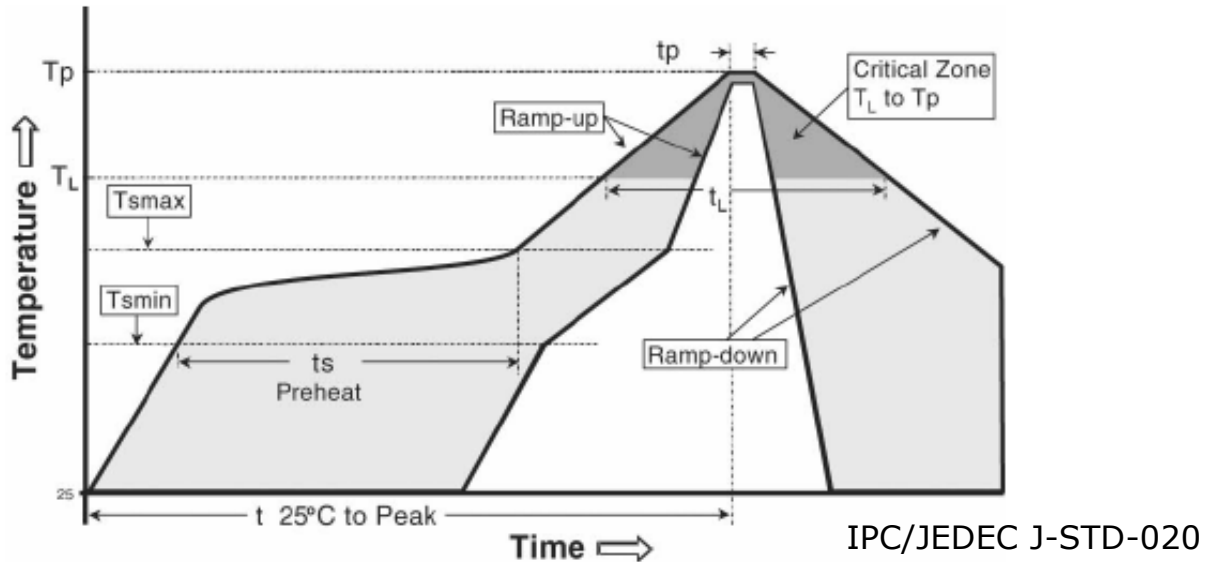

Profile Feature	Sn-Pb Eutectic Assembly	Pb-Free Assembly
Average ramp-up rate (Tsmax to T_p)	3° C/second max.	3° C/second max.
Preheat - Temperature Min (T _{sm}) - Temperature Max (T _{sm}) - Time (T _{sm} to T _{sm}) (t _s)	100 °C 150 °C 60-120 seconds	150 °C 200 °C 60-180 seconds
Time maintained above: - Temperature (T _L) - Time (t _L)	183 °C 60-150 seconds	217 °C 60-150 seconds
Peak Temperature (T _p)	215 °C	260 °C
Time within 5°C of actual Peak Temperature (t _p) ²	10-30 seconds	20-40 seconds
Ramp-down Rate	6 °C/second max.	6 °C/second max.
Time 25°C to Peak Temperature	6 minutes max.	8 minutes max.

*** Caution**

1. Reflow soldering is recommended not to be done more than two times. In the case of more than 24 hours passed soldering after first, LEDs will be damaged.
2. Repairs should not be done after the LEDs have been soldered. When repair is unavoidable, suitable tools must be used.
3. Die slug is to be soldered.
4. When soldering, do not put stress on the LEDs during heating.
5. After soldering, do not warp the circuit board.

10. Precaution for use

(1) Storage

To avoid the moisture penetration, we recommend storing Z5 Series (Z Power) LEDs in a dry box with a desiccant . The recommended storage temperature range is 5℃ to 30℃ and a maximum humidity of RH50%.

(2) Use Precaution after Opening the Packaging

Use proper SMD techniques when the LED is to be soldered dipped as separation of the lens may affect the light output efficiency. Pay attention to the following:

a. Recommend conditions after opening the package

- Sealing
- Temperature : 5 ~ 40℃ Humidity : less than RH30%

b. If the package has been opened more than 1 year (MSL 2) or the color of the desiccant changes, components should be dried for 10-12hr at 60±5℃

(3) Do not apply mechanical force or excess vibration during the cooling process to normal temperature after soldering.

(4) Do not rapidly cool device after soldering.

(5) Components should not be mounted on warped (non coplanar) portion of PCB.

(6) Radioactive exposure is not considered for the products listed here in.

(7) Gallium arsenide is used in some of the products listed in this publication. These products are dangerous if they are burned or shredded in the process of disposal. It is also dangerous to drink the liquid or inhale the gas generated by such products when chemically disposed of.

(8) This device should not be used in any type of fluid such as water, oil, organic solvent and etc. When washing is required, IPA (Isopropyl Alcohol) should be used.

(9) When the LEDs are in operation the maximum current should be decided after measuring the package temperature.

(10) LEDs must be stored properly to maintain the device. If the LEDs are stored for 3 months or more after being shipped from SSC, a sealed container with a nitrogen atmosphere should be used for storage.

(11) The appearance and specifications of the product may be modified for improvement without notice.

(12) Long time exposure of sunlight or occasional UV exposure will cause lens discoloration.

10. Precaution for use

- (13) VOCs (Volatile organic compounds) emitted from materials used in the construction of fixtures can penetrate silicone encapsulants of LEDs and discolor when exposed to heat and photonic energy. The result can be a significant loss of light output from the fixture. Knowledge of the properties of the materials selected to be used in the construction of fixtures can help prevent these issues.
- (14) The slug is isolated from anode electrically.
Therefore, we recommend that you don't isolate the heat sink.
- (15) Attaching LEDs, do not use adhesives that outgas organic vapor.
- (16) The driving circuit must be designed to allow forward voltage only when it is ON or OFF.
If the reverse voltage is applied to LED, migration can be generated resulting in LED damage.

11. Handling of Silicone Resin LEDs

- (1) During processing, mechanical stress on the surface should be minimized as much as possible. Sharp objects of all types should not be used to pierce the sealing compound.

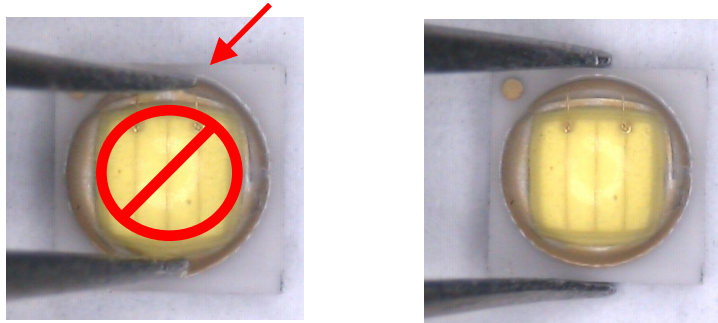

- (2) In general, LEDs should only be handled from the side. By the way, this also applies to LEDs without a silicone sealant, since the surface can also become scratched.
- (3) When populating boards in SMT production, there are basically no restrictions regarding the form of the pick and place nozzle, except that mechanical pressure on the surface of the resin must be prevented. This is assured by choosing a pick and place nozzle which is larger than the LED's reflector area.
- (4) Silicone differs from materials conventionally used for the manufacturing of LEDs. These conditions must be considered during the handling of such devices. Compared to standard encapsulants, silicone is generally softer, and the surface is more likely to attract dust. As mentioned previously, the increased sensitivity to dust requires special care during processing. In cases where a minimal level of dirt and dust particles cannot be guaranteed, a suitable cleaning solution must be applied to the surface after the soldering of components.
- (5) SSC suggests using isopropyl alcohol for cleaning. In case other solvents are used, it must be assured that these solvents do not dissolve the package or resin. Ultrasonic cleaning is not recommended. Ultrasonic cleaning may cause damage to the LED.
- (6) Please do not mold this product into another resin (epoxy, urethane, etc) and do not handle this product with acid or sulfur material in sealed space.
- (7) Avoid leaving fingerprints on silicone resin parts.



Компания «ЭлектроПласт» предлагает заключение долгосрочных отношений при поставках импортных электронных компонентов на взаимовыгодных условиях!

Наши преимущества:

- Оперативные поставки широкого спектра электронных компонентов отечественного и импортного производства напрямую от производителей и с крупнейших мировых складов;
- Поставка более 17-ти миллионов наименований электронных компонентов;
- Поставка сложных, дефицитных, либо снятых с производства позиций;
- Оперативные сроки поставки под заказ (от 5 рабочих дней);
- Экспресс доставка в любую точку России;
- Техническая поддержка проекта, помощь в подборе аналогов, поставка прототипов;
- Система менеджмента качества сертифицирована по Международному стандарту ISO 9001;
- Лицензия ФСБ на осуществление работ с использованием сведений, составляющих государственную тайну;
- Поставка специализированных компонентов (Xilinx, Altera, Analog Devices, Intersil, Interpoint, Microsemi, Aeroflex, Peregrine, Syfer, Eurofarad, Texas Instrument, Miteq, Cobham, E2V, MA-COM, Hittite, Mini-Circuits, General Dynamics и др.);

Помимо этого, одним из направлений компании «ЭлектроПласт» является направление «Источники питания». Мы предлагаем Вам помощь Конструкторского отдела:

- Подбор оптимального решения, техническое обоснование при выборе компонента;
- Подбор аналогов;
- Консультации по применению компонента;
- Поставка образцов и прототипов;
- Техническая поддержка проекта;
- Защита от снятия компонента с производства.



Как с нами связаться

Телефон: 8 (812) 309 58 32 (многоканальный)

Факс: 8 (812) 320-02-42

Электронная почта: org@eplast1.ru

Адрес: 198099, г. Санкт-Петербург, ул. Калинина, дом 2, корпус 4, литера А.