





Miniature Rocker Switch A8L

Rocker Switch for High Current Switching

- Withstands inrush currents up to 100 A due to a unique switching mechanism.
- Soft touch with firm switching action.
- Easy to mount by snap fitting.
- Contact gap of 3 mm minimum.
- UL and cUL standards approved. Conforms to EN standards.

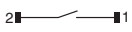

Ordering Information

Color of caps and cases (flanges)	Marking on caps	SPST 					DPST 				
		Solder terminals	PCB terminals	Right-angled PCB terminals	Left-angled PCB terminals	Quick-connect terminals #187	Solder terminals	PCB terminals	Right-angled PCB terminals	Left-angled PCB terminals	Quick-connect terminals #187
Black	Without markings	A8L-11-11N1	A8L-11-12N1	A8L-11-13N1	A8L-11-14N1	A8L-11-15N1	A8L-21-11N1	A8L-21-12N1	A8L-21-13N1	A8L-21-14N1	A8L-21-15N1
		A8L-11-11N2	A8L-11-12N2	A8L-11-13N2	A8L-11-14N2	A8L-11-15N2	A8L-21-11N2	A8L-21-12N2	A8L-21-13N2	A8L-21-14N2	A8L-21-15N2
		A8L-11-11N3	A8L-11-12N3	A8L-11-13N3	A8L-11-14N3	A8L-11-15N3	A8L-21-11N3	A8L-21-12N3	A8L-21-13N3	A8L-21-14N3	A8L-21-15N3
		A8L-11-11N6	A8L-11-12N6	A8L-11-13N6	A8L-11-14N6	A8L-11-15N6	A8L-21-11N6	A8L-21-12N6	A8L-21-13N6	A8L-21-14N6	A8L-21-15N6

Specifications

■ Ratings

Rated load	Resistive load	Lamp load	Inductive load	Inductive motor load
125 VAC	10 A	10 A	8 A	8 A
250 VAC	10 A	10 A	8 A	8 A

- Note:**
1. The non-inductive lamp load has an impulse current ten times the normal current.
 2. The inductive load has a power factor of 0.7 minimum (AC).
 3. The motor load has an impulse current 6 times the normal current.
 4. The ratings values apply under the following test conditions: Ambient temperature: 20±2°C, Ambient humidity: 65±5%, Operating frequency: 7 times/min

■ Approved Safety Standards

UL, cUL (File No. E41515)	10 A, 125 VAC; 10 A, 250 VAC
EN61058-1 (TÜV certificate no. J50021820)	10 (8) A, 250 V~

Note: Consult your OMRON representative for details of performance characteristics with respect to individual standards.

■ Characteristics

Operating frequency	Mechanical: 20 operations/min max. Electrical: 7 operations/min max.
Insulation resistance	100 MΩ min. (500 VDC)
Dielectric strength	2,000 VAC, 50/60 Hz, for 1 min between terminals of the same polarity and different polarity 4,000 VAC, 50/60 Hz, for 1 min between charged metal parts and the ground terminal
Vibration resistance	Malfunction: 10 to 55 Hz, 1.5-mm double amplitude (malfunction time of 1 ms max.)
Shock resistance	Malfunction: 300 m/s ² (malfunction time of 1 ms max.) Destruction: 500 m/s ²
Life expectancy	Mechanical: 50,000 operations min. Electrical: 10,000 operations min.
Ambient temperature	Storage: -25 to 60°C (with no icing or condensation) Operating: -20 to 55°C (with no icing or condensation)
Ambient humidity	Storage: 45% to 85% Operating: 45% to 85%
Inrush current	100 A max. (8.3 ms max.)

Dimensions

Note: Unless otherwise specified, all units are in millimeters.

■ Panel Cutouts

For Straight Terminals

(A8L-□□-□1□□, A8L-□□-□2□□), A8L-□□-□5□□)

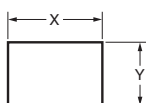

Panel thickness (mm)	X (mm)	Y (mm)
0.75 to 1.25	19.2 ⁰ _{-0.1}	12.9 ^{+0.1} ₀
1.26 to 2.5	19.4 ^{+0.1} _{-0.3}	12.9 ^{+0.1} ₀

Note: Recommended panel material: SPCC

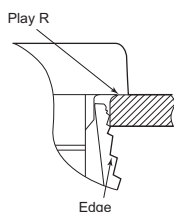

Be sure that play R is the operation side.

For Angled PCB Terminals

(A8L-□□-□3□□, A8L-□□-□4□□)

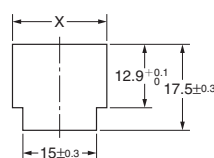

Panel thickness (mm)	X (mm)
0.75 to 1.25	19.2 ⁰ _{-0.1}
1.26 to 2.5	19.4 ^{+0.1} _{-0.3}

■ Dimensions and Operating Characteristics

Solder Terminals

A8L-11-11N1 A8L-21-11N1
A8L-11-11N2 A8L-21-11N2
A8L-11-11N3 A8L-21-11N3
A8L-11-11N6 A8L-21-11N6

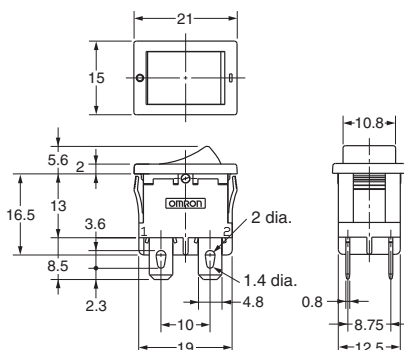
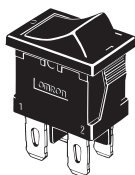

No. of poles	1	2
OF (operating force)	220 ± 120 gf	400 ± 250 gf

PCB Terminals

- A8L-11-12N1 A8L-21-12N1
- A8L-11-12N2 A8L-21-12N2
- A8L-11-12N3 A8L-21-12N3
- A8L-11-12N6 A8L-21-12N6

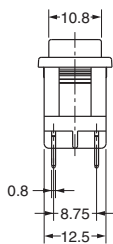
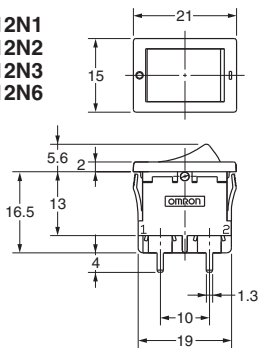
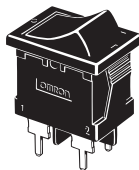

PCB Cutout Dimensions (Bottom View)

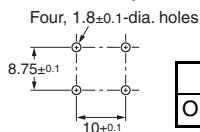

No. of poles	1	2
OF (operating force)	220 ± 120 gf	400 ± 250 gf

Right-angled PCB Terminals

- A8L-11-13N1 A8L-21-13N1
- A8L-11-13N2 A8L-21-13N2
- A8L-11-13N3 A8L-21-13N3
- A8L-11-13N6 A8L-21-13N6

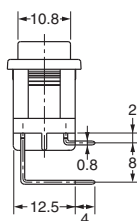
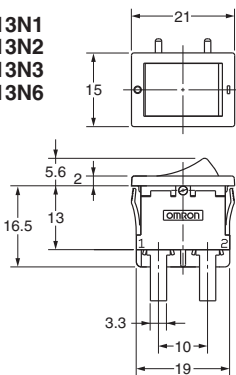
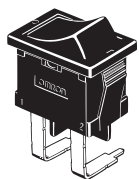

PCB Cutout Dimensions (Bottom View)

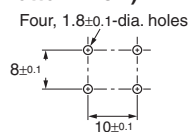

No. of poles	1	2
OF (operating force)	220 ± 120 gf	400 ± 250 gf

Left-angled PCB Terminals

- A8L-11-14N1 A8L-21-14N1
- A8L-11-14N2 A8L-21-14N2
- A8L-11-14N3 A8L-21-14N3
- A8L-11-14N6 A8L-21-14N6

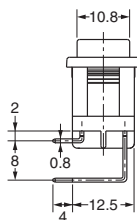
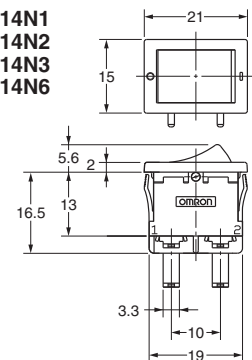
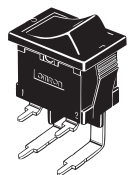

PCB Cutout Dimensions (Bottom View)

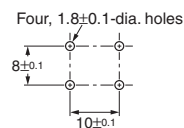

No. of poles	1	2
OF (operating force)	220 ± 120 gf	400 ± 250 gf

Quick-connect Terminals #187

- A8L-11-15N1 A8L-21-15N1
- A8L-11-15N2 A8L-21-15N2
- A8L-11-15N3 A8L-21-15N3
- A8L-11-15N6 A8L-21-15N6

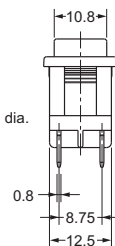
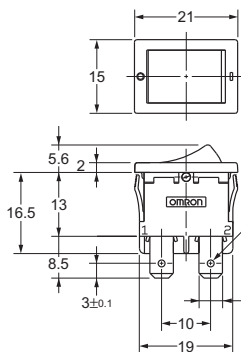
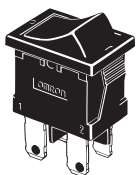

No. of poles	1	2
OF (operating force)	220 ± 120 gf	400 ± 250 gf

Precautions

■ Correct Use

Mounting

Turn OFF the power supply before mounting, removing or wiring the Switch, or before performing maintenance inspections. Failure to do so may result in electric shock.

Do not use panels other than ones with the designated thickness and dimensions. Remove all burrs from the cutout before installing the Switch. Otherwise, the Switch may malfunction.

Do not impose excessive force on the Switch at the time of panel-mounting.

There are two small divots in the flange part of the case marking ON and OFF as shown in the following diagram. Use these marks as guides when mounting.

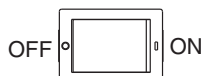

Wiring

When soldering terminals manually, perform soldering within 3 s using a 60-W soldering iron (temperature at the tip of the soldering iron: 420°C max.). Do not apply excessive force to the terminals during soldering.

When soldering using a soldering tub, perform soldering within 5 s in a soldering fluid at 270°C, or within 3 s in a soldering fluid at 350°C.

Be sure that the wires are thick enough for the load (current) to be applied.

Only A8L-□□-□5□□ models are equipped with (6.3×0.8) mm flat-quick connections for use with #187 fasten receptacles.

The terminals of A8L-□□-□1□□ are not in compliance with IEC standards for flat-quick connections. Suitable for use as solder connection only.

Using Microloads

The performance of the Switch may be affected if the Switch is used for switching micro loads. Test the Switch under the actual operating conditions.

Operating Environment

Do not use the Switch in places with sulfide gas, corrosive gas, sea breeze, oil spray, or direct sunlight. Otherwise, the Switch may malfunction.

Do not use the Switch in places that are visibly dusty. Otherwise, the contacts may fail to operate correctly.

■ Cautions

Do not wire the Switch or touch any terminal of the Switch While power is being supplied. Doing so may result in electric shock.



To increase the reliability of operation, test the Switch before actual operation.

Be sure that there is an enough insulation distance between any Switch terminal and metal part.

Handling

Do not drop the Switch. Otherwise, the Switch may malfunction.

Do not impose excessive force on the Switch. Otherwise, the Switch may deform.

The recommended panel material is SPCC. The Switch may fall off if the material is soft and cannot securely hold the Switch. When using a soft material, test the Switch with it before using the Switch in actual operation.



All sales are subject to Omron Electronic Components LLC standard terms and conditions of sale, which can be found at http://www.components.omron.com/components/web/webfiles.nsf/sales_terms.html

ALL DIMENSIONS SHOWN ARE IN MILLIMETERS.
To convert millimeters into inches, multiply by 0.03937. To convert grams into ounces, multiply by 0.03527.



OMRON ELECTRONIC COMPONENTS LLC
55 E. Commerce Drive, Suite B
Schaumburg, IL 60173

847-882-2288

OMRON ON-LINE

Global - <http://www.omron.com>
USA - <http://www.components.omron.com>

Cat. No.A114-E-04a

11/10

Specifications subject to change without notice

Printed in USA



Компания «ЭлектроПласт» предлагает заключение долгосрочных отношений при поставках импортных электронных компонентов на взаимовыгодных условиях!

Наши преимущества:

- Оперативные поставки широкого спектра электронных компонентов отечественного и импортного производства напрямую от производителей и с крупнейших мировых складов;
- Поставка более 17-ти миллионов наименований электронных компонентов;
- Поставка сложных, дефицитных, либо снятых с производства позиций;
- Оперативные сроки поставки под заказ (от 5 рабочих дней);
- Экспресс доставка в любую точку России;
- Техническая поддержка проекта, помощь в подборе аналогов, поставка прототипов;
- Система менеджмента качества сертифицирована по Международному стандарту ISO 9001;
- Лицензия ФСБ на осуществление работ с использованием сведений, составляющих государственную тайну;
- Поставка специализированных компонентов (Xilinx, Altera, Analog Devices, Intersil, Interpoint, Microsemi, Aeroflex, Peregrine, Syfer, Eurofarad, Texas Instrument, Miteq, Cobham, E2V, MA-COM, Hittite, Mini-Circuits, General Dynamics и др.);

Помимо этого, одним из направлений компании «ЭлектроПласт» является направление «Источники питания». Мы предлагаем Вам помощь Конструкторского отдела:

- Подбор оптимального решения, техническое обоснование при выборе компонента;
- Подбор аналогов;
- Консультации по применению компонента;
- Поставка образцов и прототипов;
- Техническая поддержка проекта;
- Защита от снятия компонента с производства.



Как с нами связаться

Телефон: 8 (812) 309 58 32 (многоканальный)

Факс: 8 (812) 320-02-42

Электронная почта: org@eplast1.ru

Адрес: 198099, г. Санкт-Петербург, ул. Калинина, дом 2, корпус 4, литера А.