



RoHS compliant

FEATURES

• **Excellent high frequency characteristics (50Ω, at 5GHz)**

V.S.W.R.: Max. 1.25

Insertion loss: Max. 0.5dB

Isolation: Min. 35dB

(Between open contacts)

Min. 30dB

(Between contact sets)

• **Surface mount terminal**

Surface mount terminals are now standard so there is much less work in designing PC boards.

• **Small size**

Size: 14.00 (L)×9.00 (W)×8.20 (H) mm

.551 (L)×.354 (W)×.323 (H) inch

TYPICAL APPLICATIONS

• **Measuring equipment market**

Attenuator circuits, spectrum analyzer, oscilloscope, Telecommunication equipment and tester inspection.

• **Network communications market**

Microwave communication

• **Medical instrument market**

If you wish to use in applications with low level loads or with high frequency switching, please consult us.

ORDERING INFORMATION



TYPES

1. Standard PC board terminal

Contact arrangement	Nominal coil voltage	Part No.	
		Single side stable	2 coil latching
2 Form C	3 V DC	ARJ2003	ARJ2203
	4.5V DC	ARJ204H	ARJ224H
	12 V DC	ARJ2012	ARJ2212
	24 V DC	ARJ2024	ARJ2224

Standard packing: 50 pcs. in an inner package; 500 pcs. in an outer package

2. Surface-mount terminal

1) Carton packing

Contact arrangement	Nominal coil voltage	Part No.	
		Single side stable	2 coil latching
2 Form C	3 V DC	ARJ20A03	ARJ22A03
	4.5V DC	ARJ20A4H	ARJ22A4H
	12 V DC	ARJ20A12	ARJ22A12
	24 V DC	ARJ20A24	ARJ22A24

Standard packing: 50 pcs. in an inner package; 500 pcs. in an outer package

2) Tape and reel packing

Contact arrangement	Nominal coil voltage	Part No.	
		Single side stable	2 coil latching
2 Form C	3 V DC	ARJ20A03Z	ARJ22A03Z
	4.5V DC	ARJ20A4HZ	ARJ22A4HZ
	12 V DC	ARJ20A12Z	ARJ22A12Z
	24 V DC	ARJ20A24Z	ARJ22A24Z

Standard packing: 500 pcs. in an inner package; 1,000 pcs. in an outer package

Note: Tape and reel packing symbol "-Z" is not marked on the relay. "X" type tape and reel packing (picked from 1/2/3-pin side) is also available. Suffix "X" instead of "Z".

RATING

1. Coil data

1) Single side stable

Nominal coil voltage	Pick-up voltage (at 20°C 68°F)	Drop-out voltage (at 20°C 68°F)	Nominal operating current [$\pm 10\%$] (at 20°C 68°F)	Coil resistance [$\pm 10\%$] (at 20°C 68°F)	Nominal operating power	Max. applied voltage (at 70°C 158°F)
3 V DC	75%V or less of nominal voltage (Initial)	10%V or more of nominal voltage (Initial)	66.6mA	45 Ω	200mW	110%V of nominal voltage
4.5V DC			44.4mA	101.2 Ω		
12 V DC			16.6mA	720 Ω		
24 V DC			8.3mA	2,880 Ω		

2) 2 coil latching

Nominal coil voltage	Set voltage (at 20°C 68°F)	Reset voltage (at 20°C 68°F)	Nominal operating current [$\pm 10\%$] (at 20°C 68°F)	Coil resistance [$\pm 10\%$] (at 20°C 68°F)	Nominal operating power	Max. applied voltage (at 70°C 158°F)
3 V DC	75%V or less of nominal voltage (Initial)	75%V or less of nominal voltage (Initial)	50 mA	60 Ω	150mW	110%V of nominal voltage
4.5V DC			33.3mA	135 Ω		
12 V DC			12.5mA	960 Ω		
24 V DC			6.3mA	3,840 Ω		

2. Specifications

Characteristics	Item	Specifications	
Contact	Arrangement	2 Form C	
	Contact material	Gold plating	
	Initial contact resistance, max.	Max. 150m Ω (By voltage drop 10V DC 10mA)	
Rating	Contact rating	1W (at 5GHz, Impedance 50 Ω , V.S.W.R. ≤ 1.25) 10mA 10V DC (resistive load)	
	Contact carrying power	1W (at 5GHz, Impedance 50 Ω , V.S.W.R. ≤ 1.25)	
	Max. switching voltage	30V DC	
	Max. switching current	0.3A DC	
	Nominal operating power	Single side stable: 200mW, 2 coil latching: 150mW	
High frequency characteristics (Initial) (~5GHz, Impedance 50 Ω)	V.S.W.R.	Max. 1.25	
	Insertion loss (without D.U.T. board's loss)	Max. 0.5dB	
	Isolation	Between open contacts	Min. 35dB
		Between contact sets	Min. 30dB
Input power	1W (at 5GHz, impedance 50 Ω , V.S.W.R. ≤ 1.25 , at 20°C)		
Electrical characteristics	Insulation resistance (Initial)	Min. 500M Ω (at 500V DC) Measurement at same location as "Initial breakdown voltage" section.	
	Breakdown voltage (Initial)	Between open contacts	500 Vrms for 1min. (Detection current: 10mA)
		Between contact sets	500 Vrms for 1min. (Detection current: 10mA)
		Between contact and coil	500 Vrms for 1min. (Detection current: 10mA)
		Between coil and earth terminal	500 Vrms for 1min. (Detection current: 10mA)
	Between contact and earth terminal	500 Vrms for 1min. (Detection current: 10mA)	
	Temperature rise (at 20°C)	Max. 50°C (By resistive method, nominal voltage applied to the coil, 5GHz, V.S.W.R. ≤ 1.25)	
	Operate time [Set time] (at 20°C)	Max. 5ms (Nominal operating voltage applied to the coil, excluding contact bounce time.)	
Release time [Reset time] (at 20°C)	Max. 5ms (Nominal operating voltage applied to the coil, excluding contact bounce time.) (without diode)		
Mechanical characteristics	Shock resistance	Functional	Min. 500 m/s ² (Half-wave pulse of sine wave: 6ms; detection time: 10 μ s.)
		Destructive	Min. 1,000 m/s ² (Half-wave pulse of sine wave: 11ms.)
	Vibration resistance	Functional	10 to 55 Hz at double amplitude of 3mm (Detection time: 10 μ s.)
		Destructive	10 to 55 Hz at double amplitude of 5mm
Expected life	Mechanical	Min. 10 ⁷ (at 180 cpm)	
	Electrical	Min. 10 ⁶ (at 20 cpm) (1W, at 5GHz, V.S.W.R. ≤ 1.25) Min. 10 ⁶ (at 20 cpm) (10mA 10V DC resistive load)	
Conditions	Conditions for operation, transport and storage*	Ambient temperature: -30°C to +70°C -22°F to +158°F Humidity: 5 to 85% R.H. (Not freezing and condensing at low temperature)	
Unit weight		Approx. 3 g .11 oz	

Note: * The upper operation ambient temperature limit is the maximum temperature that can satisfy the coil temperature rise value. Refer to [6] AMBIENT ENVIRONMENT in GENERAL APPLICATION GUIDELINES.

RJ (ARJ)

REFERENCE DATA

1. High frequency characteristics

Sample: ARJ20A12

Measuring method: Measured with HP network analyzer (HP8510C).

• V.S.W.R. characteristics



• Insertion loss characteristics
(without D.U.T. board's loss)



• Isolation characteristics



DIMENSIONS (mm inch)

The CAD data of the products with a **CAD Data** mark can be downloaded from: <http://industrial.panasonic.com/ac/e/>

1. Standard PC board terminal

CAD Data



Expansion of A

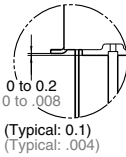

Schematic (Bottom view)

Single side stable

2 coil latching

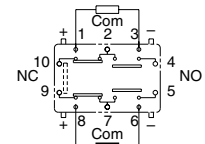
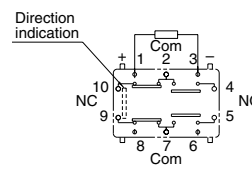

(Deenergized condition)

(Reset condition)

General tolerance: $\pm 0.3 \pm 0.12$

2. Surface mount terminal

CAD Data

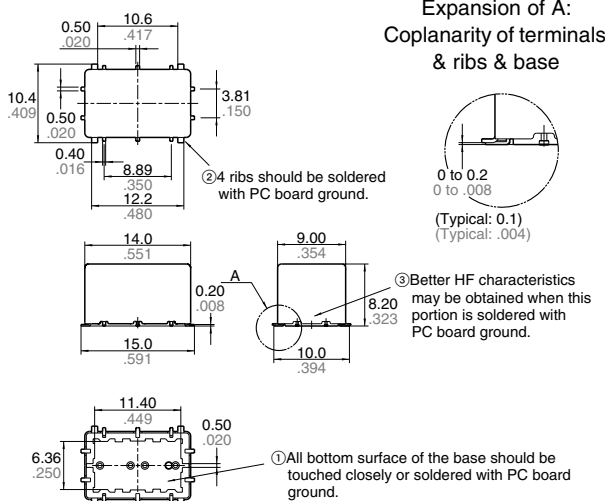

Expansion of A:
Coplanarity of terminals
& ribs & base

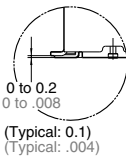

Schematic (Top view)

Single side stable

2 coil latching

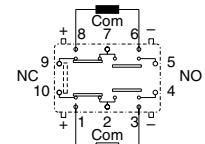
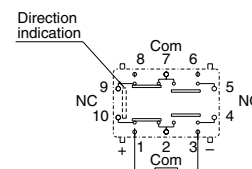

(Deenergized condition)

(Reset condition)

General tolerance: $\pm 0.3 \pm 0.12$

Note: Please consult us regarding recommended PC board patterns.

NOTES

1. Coil operating power

Pure DC current should be applied to the coil. The wave form should be rectangular. If it includes ripple, the ripple factor should be less than 5%.

However, check it with the actual circuit since the characteristics may be slightly different. The nominal operating voltage should be applied to the coil for more than 20 ms to set/reset the latching type relay.

2. Coil connection

When connecting coils, refer to the wiring diagram to prevent mis-operation or malfunction.

3. External magnetic field

Since RJ relays are highly sensitive polarized relays, their characteristics will be affected by a strong external magnetic field. Avoid using the relay under that condition.

4. Cleaning

For automatic cleaning, the boiling method is recommended. Avoid ultrasonic cleaning which subjects the relays to high frequency vibrations, which may cause the contacts to stick.

It is recommended that alcoholic solvents be used.

5. Tape and reel packing

1) Tape dimensions



2) Dimensions of plastic reel

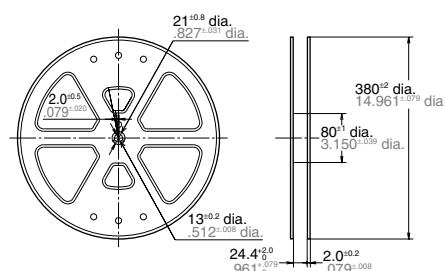

6. Conditions for operation, transport and storage conditions

1) Ambient temperature, humidity, and atmospheric pressure during usage, transport, and storage of the relay:

(1) Temperature:

−30 to +70°C −22 to +158°F

(However, tolerance range is −30 to +60°C −22 to +140°F if package is carried as is.)

(2) Humidity: 5 to 85% RH

(Avoid freezing and condensation.)

The humidity range varies with the temperature. Use within the range indicated in the graph below.

(3) Atmospheric pressure: 86 to 106 kPa

Temperature and humidity range for usage, transport, and storage:



2) Condensation

Condensation forms when there is a sudden change in temperature under high temperature and high humidity conditions. Condensation will cause deterioration of the relay insulation.

3) Freezing

Condensation or other moisture may freeze on the relay when the temperature is lower than 0°C 32°F. This causes problems such as sticking of movable parts or operational time lags.

4) Low temperature, low humidity environments

The plastic becomes brittle if the relay is exposed to a low temperature, low humidity environment for long periods of time.

5) Storage procedures for surface-mount terminal types

Since the relay is very sensitive to humidity, it is packed in humidity-free, hermetically sealed packaging. When storing the relay, be careful of the following points:

(1) Be sure to use the relay immediately after removing it from its sealed package.

(2) When storing the relay for long periods of time after removing it from its sealed package, we recommend using a humidity-free bag with silica gel to prevent subjecting the relay to humidity. Furthermore, if the relay is solder mounted when it has been subjected to excessive humidity, cracks and leaks can

occur. Be sure to mount the relay under the required mounting conditions.

7. Soldering

1) Surface-mount terminal

In case of automatic soldering, the following conditions should be observed

(1) Position of measuring temperature

Surface of PC board where relay is mounted.

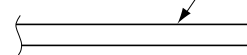

(2) IR (infrared reflow) soldering method



T₁ = 150 to 180°C 302 to 356°F t₁ = 60 to 120 sec.
T₂ = 230°C 446°F and higher t₂ = Within 30 sec.
T₃ = Within 250°C 482°F

Temperature rise of relay itself may vary according to the mounting level or the heating method of reflow equipment. Therefore, please set the temperature of soldering portion of relay terminal and the top surface of the relay case not to exceed the above mentioned soldering condition.

It is recommended to check the temperature rise of each portion under actual mounting condition before use.

2) Standard PC board terminal
Please meet the following conditions if this relay is to be automatically soldered.

(1) Preheating: Max. 120°C 248°F

(terminal solder surface) for max. 120 seconds

(2) Soldering: Max. 260±5°C 500±9°F for max. 6 seconds

The effect on the relay depends on the actual substrate used. Please verify the substrate to be used.

Moisture-proof packaging enables RJ relay's standard PCB type capable for reflow soldering.

Please contact us in the case of reflow soldering considerations.

3) Hand soldering

Please meet the following conditions if this relay is to be soldered by hand.

(1) Wattage: 30 to 60 W

(2) Tip temperature/time: 280 to 300°C 536 to 572°F for max. 5 seconds

The effect on the relay depends on the actual substrate used. Please verify the substrate to be used.

4) Avoid high frequency cleaning since this may adversely affect relay characteristics. Use alcohol-based cleaning solutions when cleaning relays.

Mouser Electronics

Authorized Distributor

Click to View Pricing, Inventory, Delivery & Lifecycle Information:

Panasonic:

[ARJ20A4H](#) [ARJ22A12](#) [ARJ2003](#) [ARJ2012](#) [ARJ2024](#) [ARJ204H](#) [ARJ20A03](#) [ARJ20A12X](#) [ARJ20A24](#) [ARJ20A4HX](#)
[ARJ20A4HZ](#) [ARJ2203](#) [ARJ2212](#) [ARJ2224](#) [ARJ224H](#) [ARJ22A03](#) [ARJ22A12X](#) [ARJ22A12Z](#) [ARJ22A24](#)
[ARJ22A4HZ](#) [ARJ20A12Z](#) [ARJ22A4H](#) [ARJ20A12](#) [ARJ22A4HX](#)



Компания «ЭлектроПласт» предлагает заключение долгосрочных отношений при поставках импортных электронных компонентов на взаимовыгодных условиях!

Наши преимущества:

- Оперативные поставки широкого спектра электронных компонентов отечественного и импортного производства напрямую от производителей и с крупнейших мировых складов;
- Поставка более 17-ти миллионов наименований электронных компонентов;
- Поставка сложных, дефицитных, либо снятых с производства позиций;
- Оперативные сроки поставки под заказ (от 5 рабочих дней);
- Экспресс доставка в любую точку России;
- Техническая поддержка проекта, помощь в подборе аналогов, поставка прототипов;
- Система менеджмента качества сертифицирована по Международному стандарту ISO 9001;
- Лицензия ФСБ на осуществление работ с использованием сведений, составляющих государственную тайну;
- Поставка специализированных компонентов (Xilinx, Altera, Analog Devices, Intersil, Interpoint, Microsemi, Aeroflex, Peregrine, Syfer, Eurofarad, Texas Instrument, Miteq, Cobham, E2V, MA-COM, Hittite, Mini-Circuits, General Dynamics и др.);

Помимо этого, одним из направлений компании «ЭлектроПласт» является направление «Источники питания». Мы предлагаем Вам помощь Конструкторского отдела:

- Подбор оптимального решения, техническое обоснование при выборе компонента;
- Подбор аналогов;
- Консультации по применению компонента;
- Поставка образцов и прототипов;
- Техническая поддержка проекта;
- Защита от снятия компонента с производства.



Как с нами связаться

Телефон: 8 (812) 309 58 32 (многоканальный)

Факс: 8 (812) 320-02-42

Электронная почта: org@eplast1.ru

Адрес: 198099, г. Санкт-Петербург, ул. Калинина, дом 2, корпус 4, литера А.