150mA 10V INPUT LDO REGULATOR

NO.EA-245-160324

OUTLINE

The RP171x Series are CMOS-based LDO regulators featuring 150mA output current. Because of the 10V maximum input voltage, RP171x can be used in 2 cell lithium-ion battery powered portable appliances and besides a portable equipment. The supply current is Typ. 23 μ A though an excellent response characteristics.

The output voltage range from 1.2V is possible. The output voltage accuracy and temperature-drift coefficient of output voltage of the RP171x Series are excellent.

RP171x has a fold-back protection circuit and a thermal shutdown circuit. Moreover, a standby mode with ultra low supply current can be realized with the chip enable function.

SC-88A and SOT-23-5 with high power dissipation packages are available.

FEATURES

- Supply Current Typ. 23 μ A
- Standby Mode Typ. 0.1 μ A
- Dropout Voltage..... Typ. 0.20V ($I_{OUT}=100\text{mA}$, $V_{OUT}=3.0\text{V}$)
Typ. 0.40V ($I_{OUT}=150\text{mA}$, $V_{OUT}=2.8\text{V}$)
- Ripple Rejection Typ. 70dB ($f=1\text{kHz}$)
- Temperature-Drift Coefficient of Output Voltage Typ. $\pm 80\text{ppm}/^\circ\text{C}$
- Line Regulation Typ. 0.02%/V
- Output Voltage Accuracy $\pm 1.0\%$
- Packages..... SC-88A, SOT-23-5
- Input Voltage Range 2.6V to 10.0V
- Output Voltage Range 1.2V to 6.0V (0.1V steps)
(For other voltages, please refer to MARK INFORMATIONS.)
- Built-in Fold Back Protection Circuit..... Typ. 40mA (Current at short mode)
- Built-in Thermal Shutdown Circuit..... Shutdown Temperature at 165 $^\circ\text{C}$
- Built-in Constant Slope Circuit (Soft-start Function)
- Ceramic capacitors are recommended to be used with this IC 1.0 μ F or more

APPLICATIONS

- Power source for portable communication equipment.
- Power source for electrical appliances such as cameras, VCRs and camcorders.
- Power source for battery-powered equipment.
- Power source for home appliances.

RP171x

NO.EA-245-160324

BLOCK DIAGRAMS

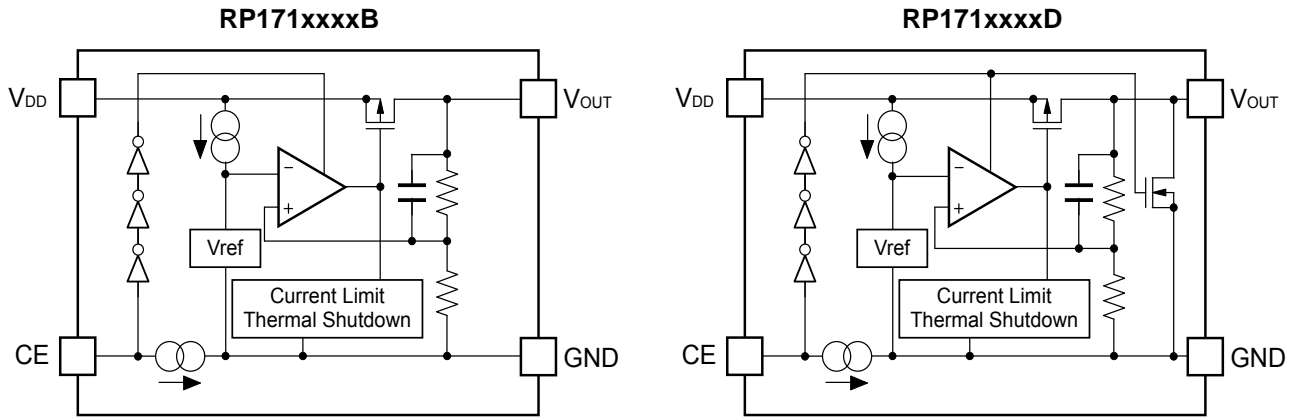

SELECTION GUIDE

The output voltage, auto discharge function, and package, etc. for the ICs can be selected at the user's request.

| Product Name | Package | Quantity per Reel | Pb Free | Halogen Free |
|------------------|----------|-------------------|---------|--------------|
| RP171Qxx2*-TR-FE | SC-88A | 3,000 pcs | Yes | Yes |
| RP171Nxx1*-TR-FE | SOT-23-5 | 3,000 pcs | Yes | Yes |

xx: The output voltage can be designated in the range from 1.2V(12) to 6.0V(60) in 0.1V steps.
(For other voltages, please refer to MARK INFORMATIONS.)

* : The auto discharge function at off state are options as follows.
(B) without auto discharge function at off state
(D) with auto discharge function at off state

PIN CONFIGURATIONS



PIN DESCRIPTIONS

• SC-88A

| Pin No | Symbol | Pin Description |
|--------|------------------|------------------------------|
| 1 | CE | Chip Enable Pin ("H" Active) |
| 2 | NC | No Connection |
| 3 | GND | Ground Pin |
| 4 | V _{OUT} | Output Pin |
| 5 | V _{DD} | Input Pin |

• SOT-23-5

| Pin No | Symbol | Pin Description |
|--------|------------------|------------------------------|
| 1 | V _{DD} | Input Pin |
| 2 | GND | Ground Pin |
| 3 | CE | Chip Enable Pin ("H" Active) |
| 4 | NC | No Connection |
| 5 | V _{OUT} | Output Pin |

ABSOLUTE MAXIMUM RATINGS

| Symbol | Item | Rating | Unit |
|-----------|-------------------------------|----------------------|------|
| V_{IN} | Input Voltage | 12 | V |
| V_{CE} | Input Voltage (CE Pin) | 12 | V |
| V_{OUT} | Output Voltage | -0.3 to $V_{IN}+0.3$ | V |
| I_{OUT} | Output Current | 330 | mA |
| P_D | Power Dissipation* (SC-88A) | 380 | mW |
| | Power Dissipation* (SOT-23-5) | 420 | |
| T_{opt} | Operating Temperature Range | -40 to 85 | °C |
| T_{stg} | Storage Temperature Range | -55 to 125 | °C |

*) For Power Dissipation, please refer to PACKAGE INFORMATION.

ABSOLUTE MAXIMUM RATINGS

Electronic and mechanical stress momentarily exceeded absolute maximum ratings may cause the permanent damages and may degrade the life time and safety for both device and system using the device in the field.

The functional operation at or over these absolute maximum ratings is not assured.

RECOMMENDED OPERATING CONDITIONS (ELECTRICAL CHARACTERISTICS)

All of electronic equipment should be designed that the mounted semiconductor devices operate within the recommended operating conditions. The semiconductor devices cannot operate normally over the recommended operating conditions, even if when they are used over such conditions by momentary electronic noise or surge. And the semiconductor devices may receive serious damage when they continue to operate over the recommended operating conditions.

ELECTRICAL CHARACTERISTICS

V_{IN}=Set V_{OUT}+1V, I_{OUT}=1mA, unless otherwise noted.

The specifications in are guaranteed by Design Engineering at -40°C ≤ T_a ≤ 85°C.

RP171xxxxB/D

T_{opt}=25°C

| Symbol | Item | Conditions | Min. | Typ. | Max. | Unit | |
|--------------------------------------|-------------------------------------------------|-----------------------------------------------------------------------------------------------------------------------------------|--------------------------------|--------|-------|--------|----|
| V _{OUT} | Output Voltage | T _{opt} =25°C | V _{OUT} > 1.5V | ×0.99 | | ×1.01 | V |
| | | | V _{OUT} ≤ 1.5V | -15 | | +15 | mV |
| | | -40°C ≤ T _{opt} ≤ 85°C | V _{OUT} > 1.5V | ×0.974 | | ×1.023 | V |
| | | | V _{OUT} ≤ 1.5V | -40 | | +35 | mV |
| I _{OUT} | Output Current | | 150 | | | mA | |
| ΔV _{OUT} /ΔI _{OUT} | Load Regulation | 0.1mA ≤ I _{OUT} ≤ 150mA | | 5 | 40 | mV | |
| V _{DIF} | Dropout Voltage | I _{OUT} =150mA | 1.2V ≤ V _{OUT} < 1.3V | | - | 1.400 | V |
| | | | 1.3V ≤ V _{OUT} < 1.5V | | - | 1.300 | |
| | | | 1.5V ≤ V _{OUT} < 1.8V | | - | 1.100 | |
| | | | 1.8V ≤ V _{OUT} < 2.3V | | - | 0.800 | |
| | | | 2.3V ≤ V _{OUT} < 3.0V | | 0.400 | 0.580 | |
| | | | 3.0V ≤ V _{OUT} < 4.0V | | 0.300 | 0.480 | |
| | | | 4.0V ≤ V _{OUT} ≤ 6.0V | | 0.250 | 0.400 | |
| I _{SS} | Supply Current | I _{OUT} =0mA | | 23 | 40 | μA | |
| I _{standby} | Standby Current | V _{IN} =10.0V, V _{CE} =GND | | 0.1 | 1.0 | μA | |
| ΔV _{OUT} /ΔV _{IN} | Line Regulation | Set V _{OUT} +0.5V ≤ V _{IN} ≤ 10.0V (In case that V _{OUT} ≤ 2.1V, 2.6V ≤ V _{IN} ≤ 10.0V) | | ±0.02 | ±0.2 | %/V | |
| RR | Ripple Rejection | f=1kHz, Ripple 0.2Vp-p, I _{OUT} =30mA (In case that V _{OUT} < 2.0V, V _{IN} =3.0V) | | 70 | | dB | |
| V _{IN} | Input Voltage | | 2.6 | | 10 | V | |
| ΔV _{OUT} /ΔT _{opt} | Output Voltage Temperature Coefficient | -40°C ≤ T _{opt} ≤ 85°C | | ±80 | | ppm/°C | |
| I _{SC} | Short Current Limit | V _{OUT} =0V | | 40 | | mA | |
| I _{PD} | CE Pull-down Current | | | 0.30 | | μA | |
| V _{CEH} | CE Input Voltage "H" | | 1.7 | | | V | |
| V _{CEL} | CE Input Voltage "L" | | | | 0.8 | V | |
| T _{TSD} | Thermal Shutdown Temperature | Junction Temperature | | 165 | | °C | |
| T _{TSR} | Thermal Shutdown Released Temperature | Junction Temperature | | 110 | | °C | |
| en | Output Noise | BW=10Hz to 100kHz | | 100 | | μVrms | |
| R _{LOW} | Low Output Nch Tr. ON Resistance (of D version) | V _{IN} =7.0V V _{CE} =0V | | 250 | | Ω | |

All of unit are tested and specified under load conditions such that T_j≈T_{opt}=25°C except for Output Noise, Ripple Rejection, Output Voltage Temperature Coefficient and Thermal Shutdown.

TYPICAL APPLICATION



(External Components)

C2 1.0 μ F MURATA: GRM155B31A105KE15

TECHNICAL NOTES

When using these ICs, consider the following points:

Phase Compensation

In these ICs, phase compensation is made for securing stable operation even if the load current is varied. For this purpose, use a capacitor C2 with 1.0 μ F or more and good ESR (Equivalent Series Resistance).

(Note: If additional ceramic capacitors are connected with parallel to the output pin with an output capacitor for phase compensation, the operation might be unstable. Because of this, test these ICs with as same external components as ones to be used on the PCB.)

PCB Layout

Make V_{DD} and GND lines sufficient. If their impedance is high, noise pickup or unstable operation may result. Connect a capacitor C1 with a capacitance value as much as 1.0 μ F or more between V_{DD} and GND pin, and as close as possible to the pins.

Set external components, especially the output capacitor C2, as close as possible to the ICs, and make wiring as short as possible.

PACKAGE INFORMATION

• Power Dissipation (SC-88A)

Power Dissipation (P_D) depends on conditions of mounting on board. This specification is based on the measurement at the condition below:

Measurement Conditions:

| | Standard Land Pattern |
|------------------|-----------------------------------------------|
| Environment | Mounting on Board (Wind velocity=0m/s) |
| Board Material | Glass cloth epoxy plastic (Double Layers) |
| Board Dimensions | 40mm × 40mm × 1.6mm |
| Copper Ratio | Top side: Approx. 50%, Back side: Approx. 50% |
| Through-hole | φ0.5mm × 44pcs |

Measurement Results:

($T_a=25^\circ\text{C}$)

| | Standard Land Pattern | Free Air |
|--------------------|------------------------------------------------------------------------------------|-----------------------------------------------------------------------|
| Power Dissipation | 380mW ($T_{j\max}=125^\circ\text{C}$) 475mW ($T_{j\max}=150^\circ\text{C}$) | 150mW |
| Thermal Resistance | $\theta_{ja}=(125-25^\circ\text{C})/0.38\text{W}=263^\circ\text{C/W}$ | $\theta_{ja}=(125-25^\circ\text{C})/0.15\text{W}=667^\circ\text{C/W}$ |
| | $\theta_{jc}=75^\circ\text{C/W}$ | - |

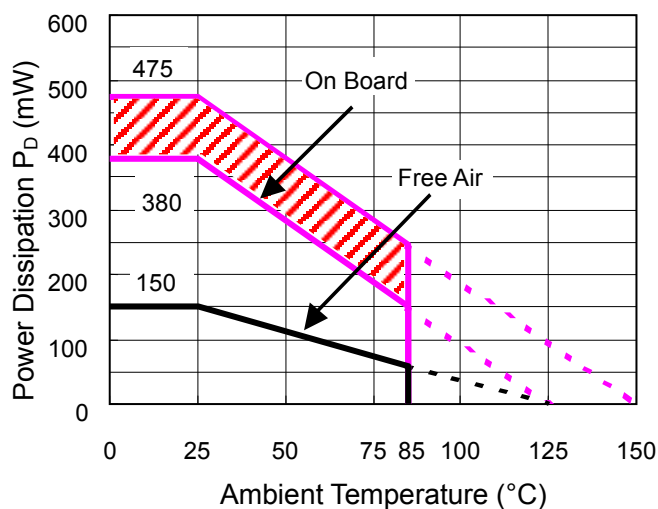

Power Dissipation

The above graph shows the Power Dissipation of the package under the conditions of $T_{j\max}=125^\circ\text{C}$ and $T_{j\max}=150^\circ\text{C}$.

The operation of the IC within the shaded range in the graph might have an affect on the IC's lifetime. The operation time of the IC must be remained within the time limit described in the table below.

| Operating Time | Estimated Years (Operating 4 hours/day) |
|----------------|--------------------------------------------|
| 13,000 hours | 9 years |

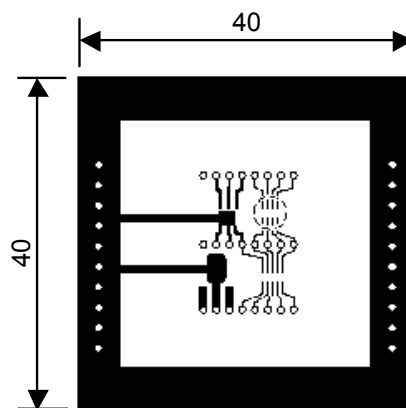

Measurement Board Pattern

⊙ IC Mount Area (Unit: mm)

• Package Dimensions (SC-88A)

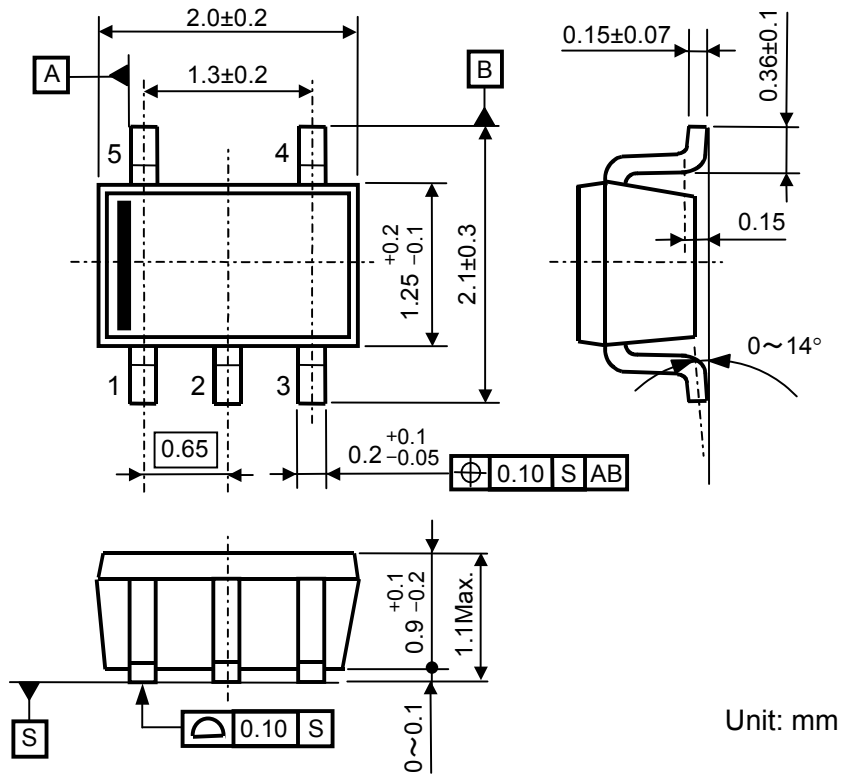

• Mark Specification (SC-88A)

①②③④: Product Code ... Refer to "Mark Specification Table".

⑤⑥: Lot Number ... Alphanumeric Serial Number



● RP171Q Series Mark Specification Table (SC-88A)

RP171Qxx2B

| Product Name | ①② ③④ | Volta ge |
|--------------|-------------|-------------|
| RP171Q122B | AC01 | 1.2V |
| RP171Q122B5 | AC02 | 1.25V |
| RP171Q132B | AC03 | 1.3V |
| RP171Q142B | AC04 | 1.4V |
| RP171Q152B | AC05 | 1.5V |
| RP171Q162B | AC06 | 1.6V |
| RP171Q172B | AC07 | 1.7V |
| RP171Q182B | AC08 | 1.8V |
| RP171Q182B5 | AC09 | 1.85V |
| RP171Q192B | AC10 | 1.9V |
| RP171Q202B | AC11 | 2.0V |
| RP171Q212B | AC12 | 2.1V |
| RP171Q222B | AC13 | 2.2V |
| RP171Q232B | AC14 | 2.3V |
| RP171Q242B | AC15 | 2.4V |
| RP171Q252B | AC16 | 2.5V |
| RP171Q262B | AC17 | 2.6V |
| RP171Q272B | AC18 | 2.7V |
| RP171Q282B | AC19 | 2.8V |
| RP171Q282B5 | AC20 | 2.85V |
| RP171Q292B | AC21 | 2.9V |

| Product Name | ①② ③④ | Volta ge |
|--------------|-------------|-------------|
| RP171Q302B | AC22 | 3.0V |
| RP171Q312B | AC23 | 3.1V |
| RP171Q322B | AC24 | 3.2V |
| RP171Q332B | AC25 | 3.3V |
| RP171Q342B | AC26 | 3.4V |
| RP171Q352B | AC27 | 3.5V |
| RP171Q362B | AC28 | 3.6V |
| RP171Q372B | AC29 | 3.7V |
| RP171Q382B | AC30 | 3.8V |
| RP171Q392B | AC31 | 3.9V |
| RP171Q402B | AC32 | 4.0V |
| RP171Q412B | AC33 | 4.1V |
| RP171Q422B | AC34 | 4.2V |
| RP171Q432B | AC35 | 4.3V |
| RP171Q442B | AC36 | 4.4V |
| RP171Q452B | AC37 | 4.5V |
| RP171Q462B | AC38 | 4.6V |
| RP171Q472B | AC39 | 4.7V |
| RP171Q482B | AC40 | 4.8V |
| RP171Q492B | AC41 | 4.9V |

| Product Name | ①② ③④ | Volta ge |
|--------------|-------------|-------------|
| RP171Q502B | AC42 | 5.0V |
| RP171Q512B | AC43 | 5.1V |
| RP171Q522B | AC44 | 5.2V |
| RP171Q532B | AC45 | 5.3V |
| RP171Q542B | AC46 | 5.4V |
| RP171Q552B | AC47 | 5.5V |
| RP171Q562B | AC48 | 5.6V |
| RP171Q572B | AC49 | 5.7V |
| RP171Q582B | AC50 | 5.8V |
| RP171Q592B | AC51 | 5.9V |
| RP171Q602B | AC52 | 6.0V |

RP171Qxx2D

| Product Name | ①② ③④ | Volta ge |
|--------------|-------------|-------------|
| RP171Q122D | AD01 | 1.2V |
| RP171Q122D5 | AD02 | 1.25V |
| RP171Q132D | AD03 | 1.3V |
| RP171Q142D | AD04 | 1.4V |
| RP171Q152D | AD05 | 1.5V |
| RP171Q162D | AD06 | 1.6V |
| RP171Q172D | AD07 | 1.7V |
| RP171Q182D | AD08 | 1.8V |
| RP171Q182D5 | AD09 | 1.85V |
| RP171Q192D | AD10 | 1.9V |
| RP171Q202D | AD11 | 2.0V |
| RP171Q212D | AD12 | 2.1V |
| RP171Q222D | AD13 | 2.2V |
| RP171Q232D | AD14 | 2.3V |
| RP171Q242D | AD15 | 2.4V |
| RP171Q252D | AD16 | 2.5V |
| RP171Q262D | AD17 | 2.6V |
| RP171Q272D | AD18 | 2.7V |
| RP171Q282D | AD19 | 2.8V |
| RP171Q282D5 | AD20 | 2.85V |
| RP171Q292D | AD21 | 2.9V |

| Product Name | ①② ③④ | Volta ge |
|--------------|-------------|-------------|
| RP171Q302D | AD22 | 3.0V |
| RP171Q312D | AD23 | 3.1V |
| RP171Q322D | AD24 | 3.2V |
| RP171Q332D | AD25 | 3.3V |
| RP171Q342D | AD26 | 3.4V |
| RP171Q352D | AD27 | 3.5V |
| RP171Q362D | AD28 | 3.6V |
| RP171Q372D | AD29 | 3.7V |
| RP171Q382D | AD30 | 3.8V |
| RP171Q392D | AD31 | 3.9V |
| RP171Q402D | AD32 | 4.0V |
| RP171Q412D | AD33 | 4.1V |
| RP171Q422D | AD34 | 4.2V |
| RP171Q432D | AD35 | 4.3V |
| RP171Q442D | AD36 | 4.4V |
| RP171Q452D | AD37 | 4.5V |
| RP171Q462D | AD38 | 4.6V |
| RP171Q472D | AD39 | 4.7V |
| RP171Q482D | AD40 | 4.8V |
| RP171Q492D | AD41 | 4.9V |

| Product Name | ①② ③④ | Volta ge |
|--------------|-------------|-------------|
| RP171Q502D | AD42 | 5.0V |
| RP171Q512D | AD43 | 5.1V |
| RP171Q522D | AD44 | 5.2V |
| RP171Q532D | AD45 | 5.3V |
| RP171Q542D | AD46 | 5.4V |
| RP171Q552D | AD47 | 5.5V |
| RP171Q562D | AD48 | 5.6V |
| RP171Q572D | AD49 | 5.7V |
| RP171Q582D | AD50 | 5.8V |
| RP171Q592D | AD51 | 5.9V |
| RP171Q602D | AD52 | 6.0V |

RP171x

NO.EA-245-160324

• Power Dissipation (SOT-23-5)

Power Dissipation (P_D) depends on conditions of mounting on board. This specification is based on the measurement at the condition below:

(Power Dissipation (SOT-23-5) is substitution of SOT-23-6.)

Measurement Conditions:

| | Standard Land Pattern |
|------------------|-----------------------------------------------|
| Environment | Mounting on Board (Wind velocity=0m/s) |
| Board Material | Glass cloth epoxy plastic (Double sided) |
| Board Dimensions | 40mm × 40mm × 1.6mm |
| Copper Ratio | Top side: Approx. 50%, Back side: Approx. 50% |
| Through-holes | φ 0.5mm × 44pcs |

Measurement Results:

($T_a=25^\circ\text{C}$)

| | Standard Land Pattern | Free Air |
|--------------------|------------------------------------------------------------------------------------|------------------------|
| Power Dissipation | 420mW ($T_{j\max}=125^\circ\text{C}$) 525mW ($T_{j\max}=150^\circ\text{C}$) | 250mW |
| Thermal Resistance | $\theta_{ja} = (125-25^\circ\text{C})/0.42\text{W} = 238^\circ\text{C/W}$ | 400 $^\circ\text{C/W}$ |



Power Dissipation



Measurement Board Pattern

○ IC Mount Area (Unit: mm)

The above graph shows the Power Dissipation of the package under the conditions of $T_{j\max}=125^\circ\text{C}$ and $T_{j\max}=150^\circ\text{C}$.

The operation of the IC within the shaded range in the graph might have an affect on the IC's lifetime. The operation time of the IC must be remained within the time limit described in the table below.

| Operating Time | Estimated Years (Operating 4 hours/day) |
|----------------|--------------------------------------------|
| 13,000 hours | 9 years |

• Package Dimensions (SOT-23-5)



Unit: mm

• Mark Specification (SOT-23-5)

①②③: Product Code ... Refer to "Mark Specification Table".

④⑤: Lot Number ... Alphanumeric Serial Number



RP171x

NO.EA-245-160324

• RP171N Series Mark Specification Table (SOT-23-5)**RP171Nxx1B**

| Product Name | ①② ③ | Volta ge |
|--------------|------------|-------------|
| RP171N121B | JAA | 1.2V |
| RP171N121B5 | JAB | 1.25V |
| RP171N131B | JAC | 1.3V |
| RP171N141B | JAD | 1.4V |
| RP171N151B | JAE | 1.5V |
| RP171N161B | JAF | 1.6V |
| RP171N171B | JAG | 1.7V |
| RP171N181B | JAH | 1.8V |
| RP171N181B5 | JAJ | 1.85V |
| RP171N191B | JAK | 1.9V |
| RP171N201B | JAL | 2.0V |
| RP171N211B | JAM | 2.1V |
| RP171N221B | JAN | 2.2V |
| RP171N231B | JAP | 2.3V |
| RP171N241B | JAQ | 2.4V |
| RP171N251B | JAR | 2.5V |
| RP171N261B | JAS | 2.6V |
| RP171N271B | JAT | 2.7V |
| RP171N281B | JAU | 2.8V |
| RP171N281B5 | JAV | 2.85V |
| RP171N291B | JAW | 2.9V |

| Product Name | ①② ③ | Volta ge |
|--------------|------------|-------------|
| RP171N301B | JAX | 3.0V |
| RP171N311B | JAY | 3.1V |
| RP171N321B | JAZ | 3.2V |
| RP171N331B | KAA | 3.3V |
| RP171N341B | KAB | 3.4V |
| RP171N351B | KAC | 3.5V |
| RP171N361B | KAD | 3.6V |
| RP171N371B | KAE | 3.7V |
| RP171N381B | KAF | 3.8V |
| RP171N391B | KAG | 3.9V |
| RP171N401B | KAH | 4.0V |
| RP171N411B | KAJ | 4.1V |
| RP171N421B | KAK | 4.2V |
| RP171N431B | KAL | 4.3V |
| RP171N441B | KAM | 4.4V |
| RP171N451B | KAN | 4.5V |
| RP171N461B | KAP | 4.6V |
| RP171N471B | KAQ | 4.7V |
| RP171N481B | KAR | 4.8V |
| RP171N491B | KAS | 4.9V |

| Product Name | ①② ③ | Volta ge |
|--------------|------------|-------------|
| RP171N501B | KAT | 5.0V |
| RP171N511B | KAU | 5.1V |
| RP171N521B | KAV | 5.2V |
| RP171N531B | KAW | 5.3V |
| RP171N541B | KAX | 5.4V |
| RP171N551B | KAY | 5.5V |
| RP171N561B | KAZ | 5.6V |
| RP171N571B | LAA | 5.7V |
| RP171N581B | LAB | 5.8V |
| RP171N591B | LAC | 5.9V |
| RP171N601B | LAD | 6.0V |

RP171Nxx1D

| Product Name | ①② ③ | Volta ge |
|--------------|------------|-------------|
| RP171N121D | JBA | 1.2V |
| RP171N121D5 | JBB | 1.25V |
| RP171N131D | JBC | 1.3V |
| RP171N141D | JBD | 1.4V |
| RP171N151D | JBE | 1.5V |
| RP171N161D | JBF | 1.6V |
| RP171N171D | JBG | 1.7V |
| RP171N181D | JBH | 1.8V |
| RP171N181D5 | JBJ | 1.85V |
| RP171N191D | JBK | 1.9V |
| RP171N201D | JBL | 2.0V |
| RP171N211D | JBM | 2.1V |
| RP171N221D | JBN | 2.2V |
| RP171N231D | JBP | 2.3V |
| RP171N241D | JBQ | 2.4V |
| RP171N251D | JBR | 2.5V |
| RP171N261D | JBS | 2.6V |
| RP171N271D | JBT | 2.7V |
| RP171N281D | JBU | 2.8V |
| RP171N281D5 | JBV | 2.85V |
| RP171N291D | JBW | 2.9V |

| Product Name | ①② ③ | Volta ge |
|--------------|------------|-------------|
| RP171N301D | JBX | 3.0V |
| RP171N311D | JBZ | 3.1V |
| RP171N321D | JBZ | 3.2V |
| RP171N331D | KBA | 3.3V |
| RP171N341D | KBB | 3.4V |
| RP171N351D | KBC | 3.5V |
| RP171N361D | KBD | 3.6V |
| RP171N371D | KBE | 3.7V |
| RP171N381D | KBF | 3.8V |
| RP171N391D | KBG | 3.9V |
| RP171N401D | KBH | 4.0V |
| RP171N411D | KBJ | 4.1V |
| RP171N421D | KBK | 4.2V |
| RP171N431D | KBL | 4.3V |
| RP171N441D | KBM | 4.4V |
| RP171N451D | KBN | 4.5V |
| RP171N461D | KBP | 4.6V |
| RP171N471D | KBQ | 4.7V |
| RP171N481D | KBR | 4.8V |
| RP171N491D | KBS | 4.9V |

| Product Name | ①② ③ | Volta ge |
|--------------|------------|-------------|
| RP171N501D | KBT | 5.0V |
| RP171N511D | KBU | 5.1V |
| RP171N521D | KBV | 5.2V |
| RP171N531D | KBW | 5.3V |
| RP171N541D | KBX | 5.4V |
| RP171N551D | KBY | 5.5V |
| RP171N561D | KBZ | 5.6V |
| RP171N571D | LBA | 5.7V |
| RP171N581D | LBB | 5.8V |
| RP171N591D | LBC | 5.9V |
| RP171N601D | LBD | 6.0V |

TEST CIRCUITS



Basic Test Circuit



Test Circuit for Supply Current



Test Circuit for Ripple Rejection



Test Circuit for Load Transient Response

TYPICAL CHARACTERISTICS

1) Output Voltage vs. Output Current (T_{opt}=25°C)



2) Output Voltage vs. Input Voltage (T_{opt}=25°C)

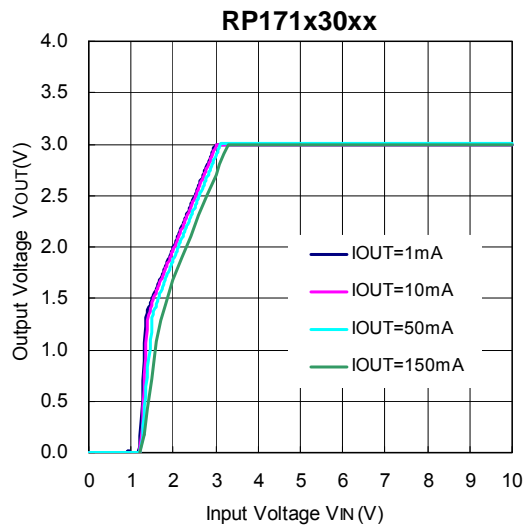



3) Supply Current vs. Input Voltage ($T_{opt}=25^{\circ}C$)



RP171x

NO.EA-245-160324

4) Supply Current vs. Output Current ($T_{opt}=25^{\circ}\text{C}$)



5) Output Voltage vs. Temperature



6) Supply Current vs. Temperature

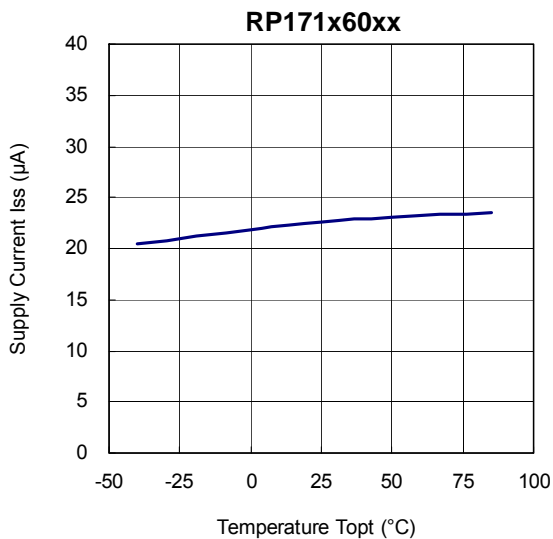

7) Dropout Voltage vs. Output Current



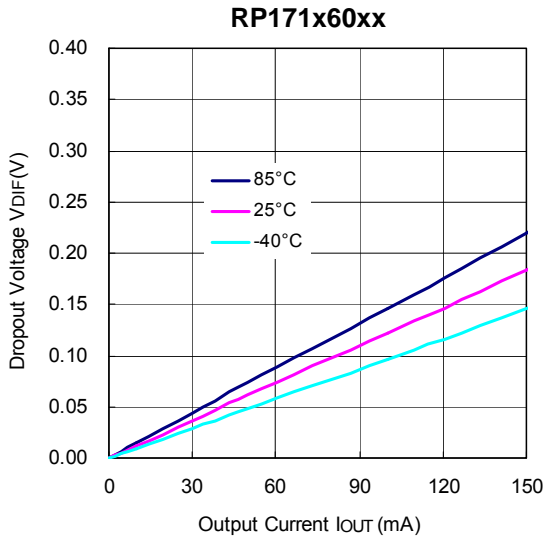

8) Dropout Voltage vs. Set Output Voltage (T_{opt}=25°C)

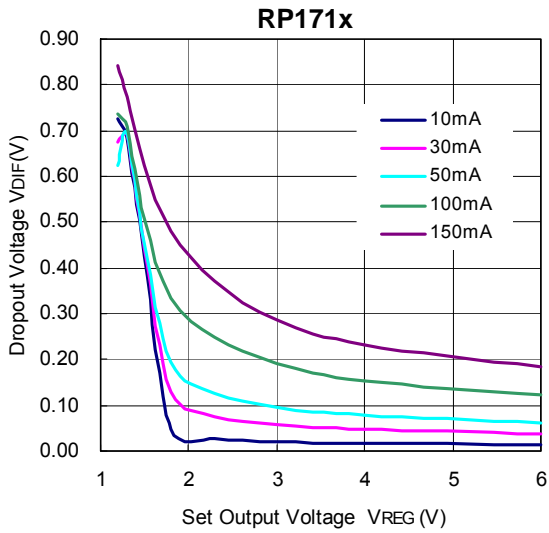

9) Minimum Operating Voltage

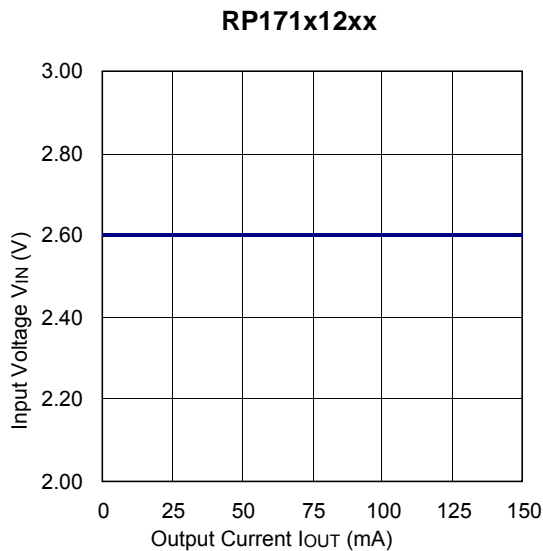

10) Ripple Rejection vs. Input Bias Voltage (C1=none, C2=Ceramic 1.0μF, Ripple=0.2Vp-p, T_{opt}=25°C)

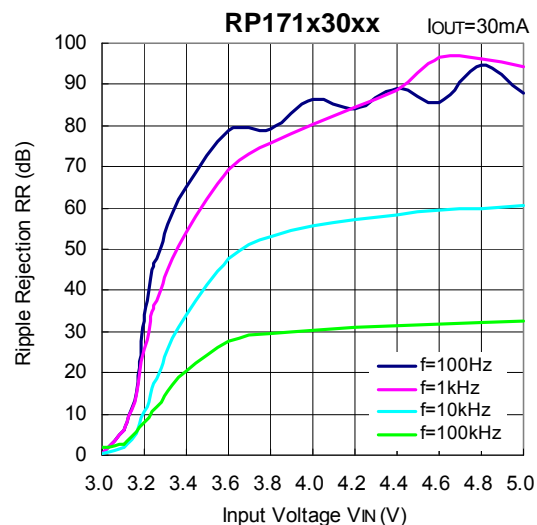

11) Ripple Rejection vs. Frequency (C1=none, C2=Ceramic 1.0μF, T_{opt}=25°C)

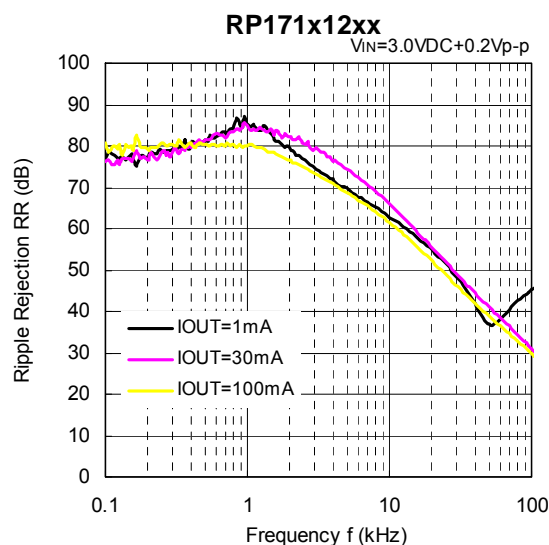
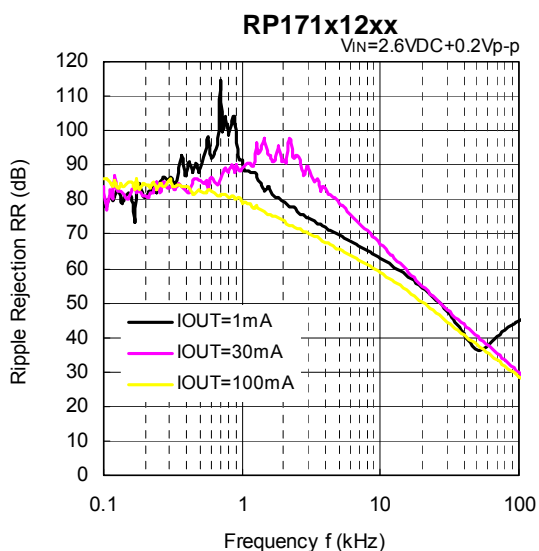

RP171x

NO.EA-245-160324

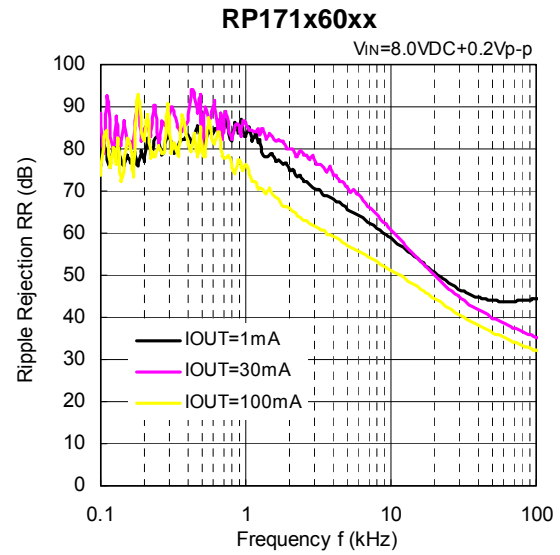

12) Input Transient Response (C1=none, IOUT=30mA, tr=tf=5μs, Topt=25°C)

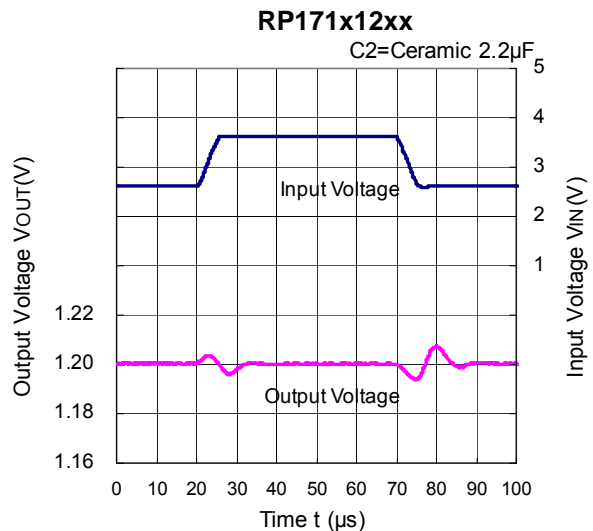



13) Load Transient Response (C1=Ceramic 1.0 μ F, $t_r=t_f=500ns$, $T_{opt}=25^{\circ}C$)



RP171x12xx



RP171x30xx



RP171x30xx



RP171x30xx





RP171x

NO.EA-245-160324

14) Turn On Speed with CE pin (C1=Ceramic 1.0μF, T_{opt}=25°C)

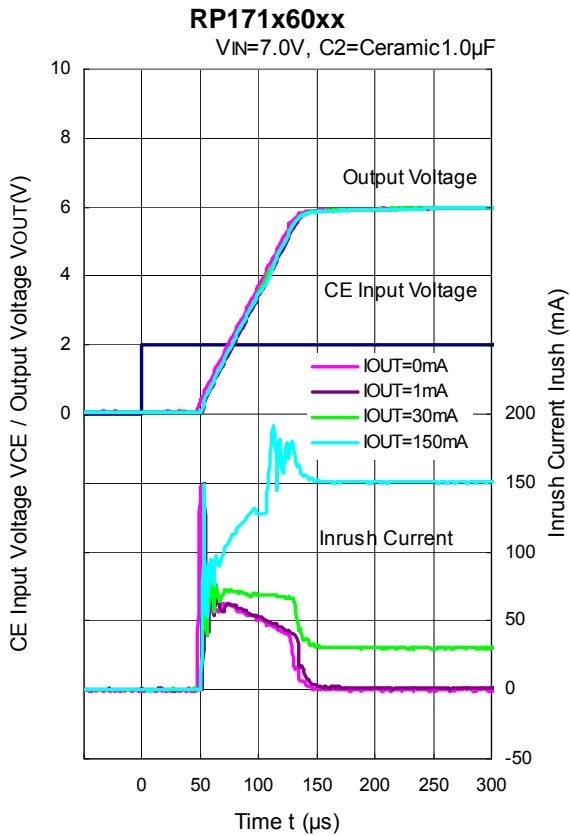

RP171x12xx

$V_{IN}=2.6V, I_{OUT}=1mA$



RP171x30xx

$V_{IN}=4.0V, I_{OUT}=1mA$



RP171x60xx

$V_{IN}=7.0V, I_{OUT}=1mA$



RP171x

NO.EA-245-160324

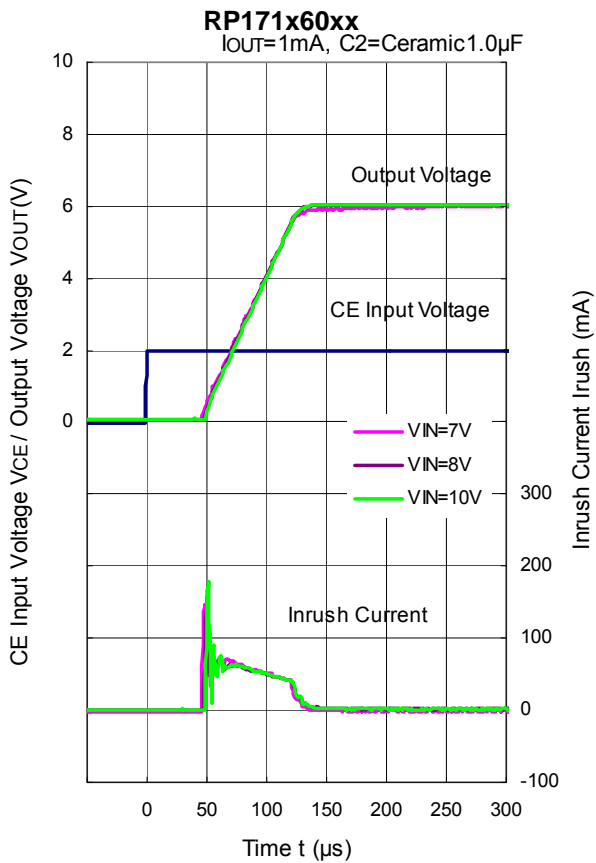
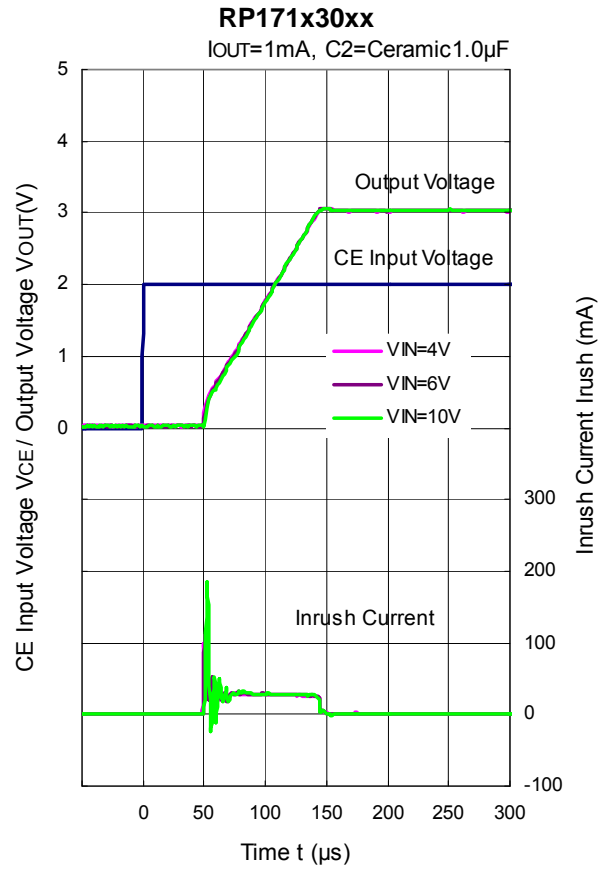
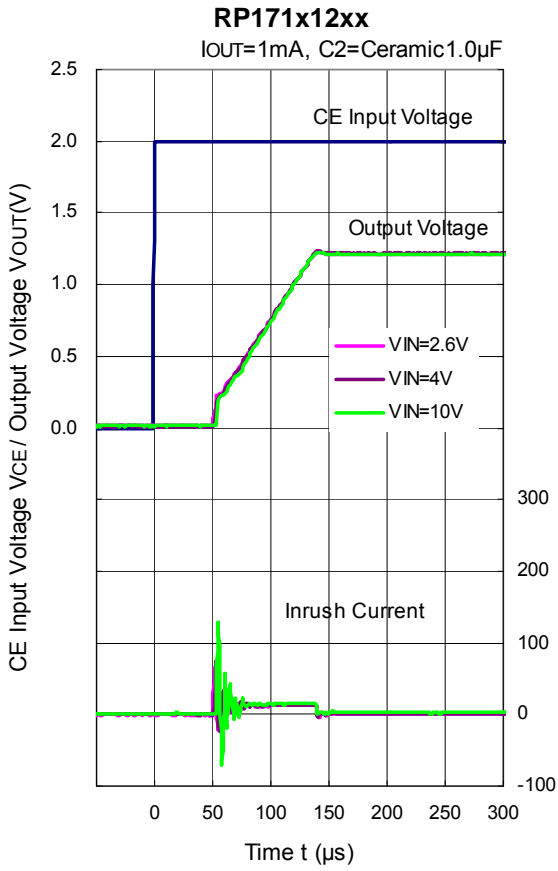

15) Turn Off Speed with CE pin (D Version) (C1=Ceramic 1.0μF, T_{opt}=25°C)

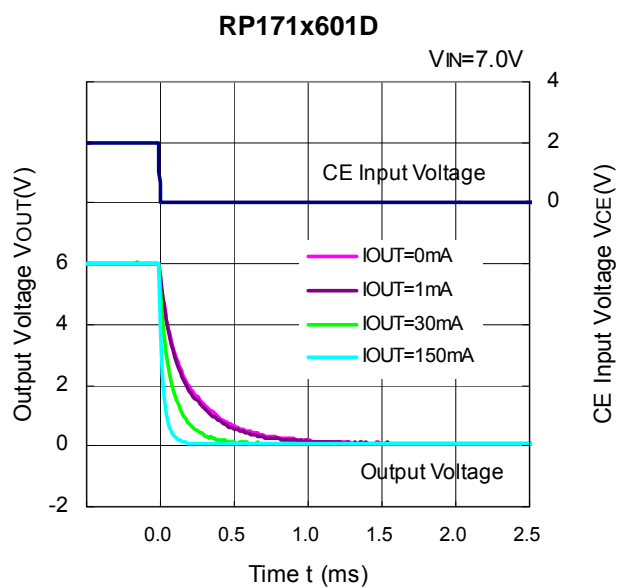
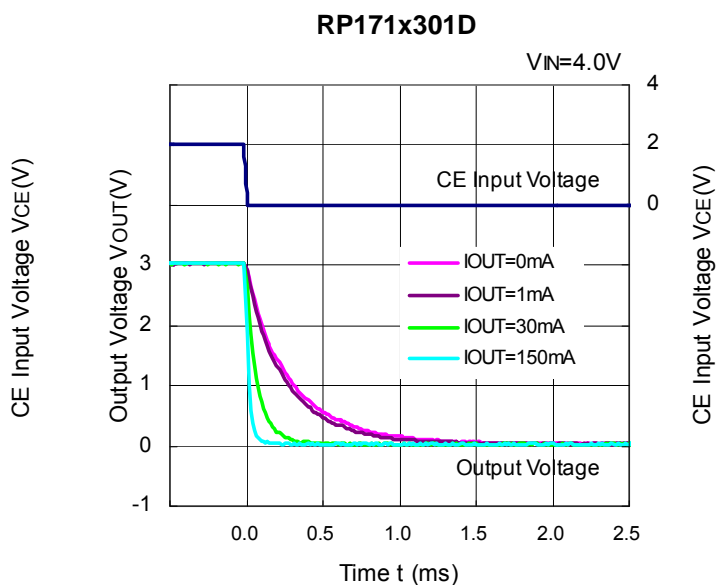
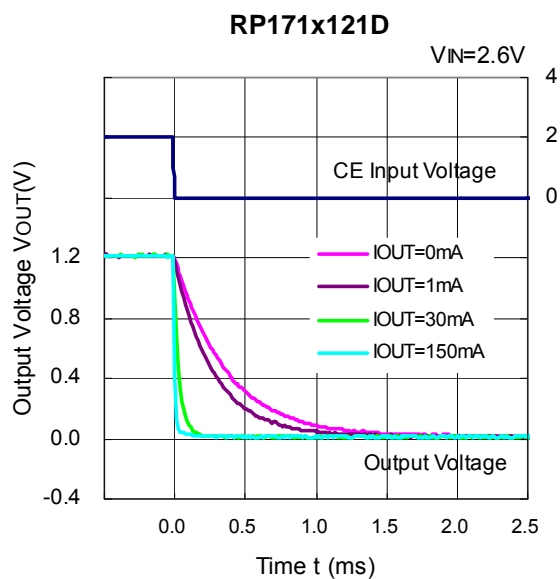

ESR vs. Output Current

When using these ICs, consider the following points:

The relations between I_{OUT} (Output Current) and ESR of an output capacitor are shown below.

The conditions when the white noise level is under $40\mu\text{V}$ (Avg.) are marked as the hatched area in the graph.

Measurement conditions

Frequency Band : 10Hz to 2MHz

Temperature : -40°C to 85°C

C1, C2 : Ceramic $1.0\mu\text{F}$ (Murata GRM155B31A105KE)

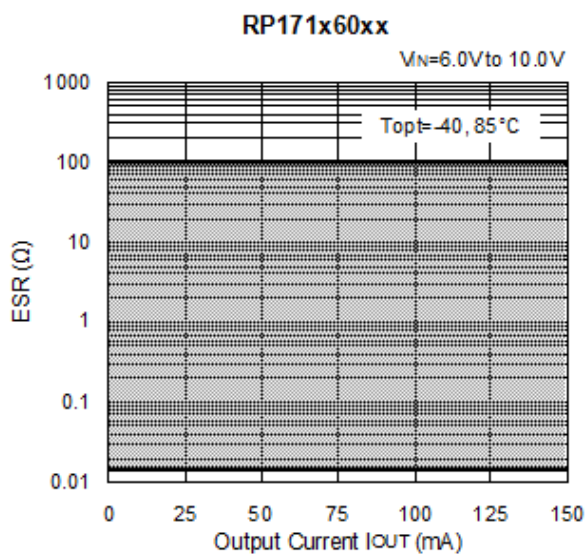



1. The products and the product specifications described in this document are subject to change or discontinuation of production without notice for reasons such as improvement. Therefore, before deciding to use the products, please refer to Ricoh sales representatives for the latest information thereon.
2. The materials in this document may not be copied or otherwise reproduced in whole or in part without prior written consent of Ricoh.
3. Please be sure to take any necessary formalities under relevant laws or regulations before exporting or otherwise taking out of your country the products or the technical information described herein.
4. The technical information described in this document shows typical characteristics of and example application circuits for the products. The release of such information is not to be construed as a warranty of or a grant of license under Ricoh's or any third party's intellectual property rights or any other rights.
5. The products listed in this document are intended and designed for use as general electronic components in standard applications (office equipment, telecommunication equipment, measuring instruments, consumer electronic products, amusement equipment etc.). Those customers intending to use a product in an application requiring extreme quality and reliability, for example, in a highly specific application where the failure or misoperation of the product could result in human injury or death (aircraft, spacevehicle, nuclear reactor control system, traffic control system, automotive and transportation equipment, combustion equipment, safety devices, life support system etc.) should first contact us.
6. We are making our continuous effort to improve the quality and reliability of our products, but semiconductor products are likely to fail with certain probability. In order to prevent any injury to persons or damages to property resulting from such failure, customers should be careful enough to incorporate safety measures in their design, such as redundancy feature, fire containment feature and fail-safe feature. We do not assume any liability or responsibility for any loss or damage arising from misuse or inappropriate use of the products.
7. Anti-radiation design is not implemented in the products described in this document.
8. Please contact Ricoh sales representatives should you have any questions or comments concerning the products or the technical information.



Ricoh is committed to reducing the environmental loading materials in electrical devices with a view to contributing to the protection of human health and the environment.

Ricoh has been providing RoHS compliant products since April 1, 2006 and Halogen-free products since April 1, 2012.

RICOH RICOH ELECTRONIC DEVICES CO., LTD.

<http://www.e-devices.ricoh.co.jp/en/>

Sales & Support Offices

RICOH ELECTRONIC DEVICES CO., LTD.

Higashi-Shinagawa Office (International Sales)
3-32-3, Higashi-Shinagawa, Shinagawa-ku, Tokyo 140-8655, Japan
Phone: +81-3-5479-2857 Fax: +81-3-5479-0502

RICOH EUROPE (NETHERLANDS) B.V.

Semiconductor Support Centre
Prof. W.H. Keesomlaan 1, 1183 DJ Amstelveen, The Netherlands
Phone: +31-20-5474-309

RICOH INTERNATIONAL B.V. - German Branch

Semiconductor Sales and Support Centre
Oberrather Strasse 6, 40472 Düsseldorf, Germany
Phone: +49-211-6546-0

RICOH ELECTRONIC DEVICES KOREA CO., LTD.

3F, Haesung Bldg, 504, Teheran-ro, Gangnam-gu, Seoul, 135-725, Korea
Phone: +82-2-2135-5700 Fax: +82-2-2051-5713

RICOH ELECTRONIC DEVICES SHANGHAI CO., LTD.

Room 403, No.2 Building, No.690 Bibo Road, Pu Dong New District, Shanghai 201203, People's Republic of China
Phone: +86-21-5027-3200 Fax: +86-21-5027-3299

RICOH ELECTRONIC DEVICES CO., LTD.

Taipei office
Room 109, 10F-1, No.51, Hengyang Rd., Taipei City, Taiwan (R.O.C.)
Phone: +886-2-2313-1621/1622 Fax: +886-2-2313-1623

Mouser Electronics

Authorized Distributor

Click to View Pricing, Inventory, Delivery & Lifecycle Information:

Ricoh Electronics:

[RP171N251B-TR-FE](#) [RP171N181B-TR-FE](#) [RP171N281D-TR-FE](#) [RP171N331B-TR-FE](#) [RP171N301D-TR-FE](#)
[RP171N601B-TR-FE](#) [RP171N501D-TR-FE](#) [RP171N151B-TR-FE](#) [RP171N121B-TR-FE](#) [RP171N301B-TR-FE](#)
[RP171N331D-TR-FE](#) [RP171N281B-TR-FE](#) [RP171N501B-TR-FE](#)



Компания «ЭлектроПласт» предлагает заключение долгосрочных отношений при поставках импортных электронных компонентов на взаимовыгодных условиях!

Наши преимущества:

- Оперативные поставки широкого спектра электронных компонентов отечественного и импортного производства напрямую от производителей и с крупнейших мировых складов;
- Поставка более 17-ти миллионов наименований электронных компонентов;
- Поставка сложных, дефицитных, либо снятых с производства позиций;
- Оперативные сроки поставки под заказ (от 5 рабочих дней);
- Экспресс доставка в любую точку России;
- Техническая поддержка проекта, помощь в подборе аналогов, поставка прототипов;
- Система менеджмента качества сертифицирована по Международному стандарту ISO 9001;
- Лицензия ФСБ на осуществление работ с использованием сведений, составляющих государственную тайну;
- Поставка специализированных компонентов (Xilinx, Altera, Analog Devices, Intersil, Interpoint, Microsemi, Aeroflex, Peregrine, Syfer, Eurofarad, Texas Instrument, Miteq, Cobham, E2V, MA-COM, Hittite, Mini-Circuits, General Dynamics и др.);

Помимо этого, одним из направлений компании «ЭлектроПласт» является направление «Источники питания». Мы предлагаем Вам помощь Конструкторского отдела:

- Подбор оптимального решения, техническое обоснование при выборе компонента;
- Подбор аналогов;
- Консультации по применению компонента;
- Поставка образцов и прототипов;
- Техническая поддержка проекта;
- Защита от снятия компонента с производства.



Как с нами связаться

Телефон: 8 (812) 309 58 32 (многоканальный)

Факс: 8 (812) 320-02-42

Электронная почта: org@eplast1.ru

Адрес: 198099, г. Санкт-Петербург, ул. Калинина, дом 2, корпус 4, литера А.