

## General Description

The AAT1217 is a high efficiency, synchronous, fixed frequency, step-up converter designed for single-cell or dual-cell alkaline, NiMH, or NiCd battery-powered applications. The high 1.2MHz switching frequency and completely integrated control circuitry minimize the total solution footprint area while maintaining excellent regulation, ripple, and transient response throughout the full load range.

Light load mode operation and low quiescent current allow the AAT1217 to maintain high efficiency performance for light load conditions. With a 1.2A peak inductor current limit, the AAT1217 is capable of delivering 100mA to the load from a single AA cell, 400mA from dual AA cells, or up to 500mA from a single-cell lithium-ion battery. The AAT1217 has a 0.85V start-up voltage with operation down to 0.5V.

The AAT1217 is available in a Pb-free, space-saving low profile (1mm) 6-pin TSOT23 or 6-pin SOT23 package and is rated over the -40°C to +85°C ambient temperature range.

## Features

- $V_{IN}$  Operation Range: 0.5V to  $V_{OUT}$
- $V_{OUT}$  Range: 2.5V to 5.5V
- 100mA Output from a Single AA Cell Input
- 400mA Output from a Dual AA Cell Input
- 500mA Output from a Single Li+ Cell Input
- High Efficiency: Up to 93% Efficiency
- Low Start-Up Voltage: 0.85V Typical
- Internal Synchronous Rectifier
  - $V_{OUT} \leq 4.5V$ : No External Schottky Diode
- Fixed Frequency Pulse Width Modulation (PWM) Current-Mode Control Scheme with Internal Compensation
- 1.2MHz Fixed Switching Frequency
- 1.2A Current Limit
- Light Load Mode Operation
- Over-Current Protection
- EMI Reduction Anti-Ringing Control Circuitry
- Low Shutdown Current:  $<1.0\mu A$
- -40°C to +85°C Ambient Temperature Range
- Low Profile (1mm) TSOT23-6 or SOT23-6 Package

## Applications

- Cellular and Smart Phones
- Digital Still and Video Cameras
- Microprocessors and DSP Core Supplies
- MP3 Player
- Portable Instruments
- Wireless and DSL Modems

## Typical Application

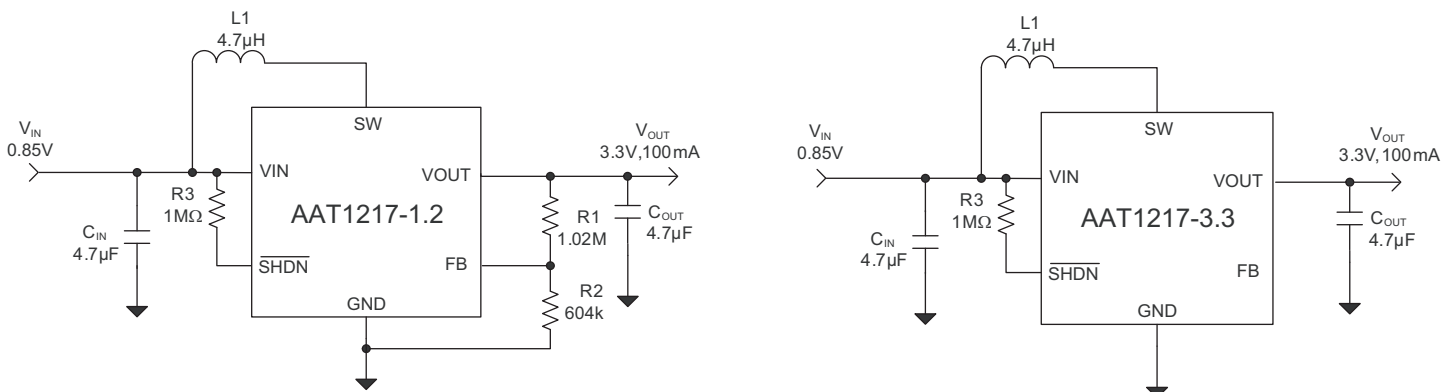

## Pin Descriptions

| Pin # | Symbol                   | Function  |
|-------|--------------------------|---|
| 1     | SW                       | Power Switch Pin. Ties to the drains of the PMOS synchronous rectifier and the NMOS switch.                                   |
| 2     | GND                      | Ground Pin  |
| 3     | FB                       | Feedback Input Pin. Connect FB to the center point of the external resistor divider. The feedback threshold voltage is 1.23V. |
| 4     | $\overline{\text{SHDN}}$ | Shutdown Signal Input. Logic high enables the IC. Logic low disables the IC. Shutdown current is $<1\mu\text{A}$ .            |
| 5     | VOUT                     | Power Output Pin. Tied to the source of the PMOS synchronous rectifier.   |
| 6     | VIN                      | Power Supply Input. Must be closely decoupled to GND, Pin 2, with a $4.7\mu\text{F}$ or greater ceramic capacitor.            |

## Pin Configuration

**TSOT23-6/SOT23-6  
(Top View)**

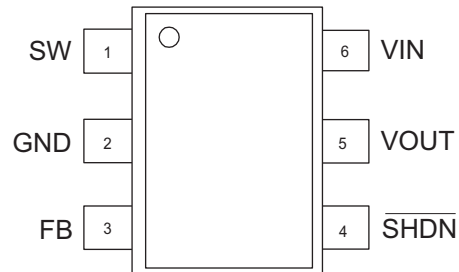

## Absolute Maximum Ratings<sup>1</sup>

| Symbol             | Description                                       | Value      | Units |
|--------------------|---|------------|-------|
| $V_{IN}$           | Input Supply Voltage                              | -0.3 to 6  | V     |
| $V_{SW}$           | SW Voltage  | -0.3 to 6  | V     |
| $V_{FB}, V_{SHDN}$ | FB, SHDN Voltages                                 | -0.3 to 6  | V     |
| $V_{OUT}$          | VOUT Voltage                                      | -0.3 to 6  | V     |
| $T_A$              | Operating Ambient Temperature Range <sup>2</sup>  | -40 to 85  | °C    |
| $T_{STORAGE}$      | Storage Temperature Range                         | -65 to 150 | °C    |
| $T_{LEAD}$         | Lead Temperature (Soldering, 10s)                 | 300        | °C    |
| $T_J$              | Operating Junction Temperature Range <sup>2</sup> | -40 to 150 | °C    |

## Thermal Information<sup>3</sup>

| Symbol        | Description                | Value    | Units |
|---------------|----------------------------|----------|-------|
| $\theta_{JA}$ | Maximum Thermal Resistance | TSOT23-6 | 190   |
|               |                            | SOT23-6  | 150   |
| $P_D$         | Maximum Power Dissipation  | TSOT23-6 | 526   |
|               |                            | SOT23-6  | 667   |

1. Absolute Maximum Ratings are those values beyond which the life of a device may be impaired.

2.  $T_J$  is calculated from the ambient temperature  $T_A$  and power dissipation  $P_D$  according to the following formula:  $T_J = T_A + P_D \times \theta_{JA}$ .

3. Mounted on an FR4 board.

## Electrical Characteristics<sup>1</sup>

$V_{IN} = 1.2V$ ,  $V_{OUT} = 3.3V$ ,  $T_A = 25^\circ C$ , unless otherwise noted.

| Symbol  | Description                          | Conditions   | Min   | Typ   | Max   | Units      |
|---|--------------------------------------|--|-------|-------|-------|------------|
| $V_{IN}$  | Minimum Start-Up Voltage             | $I_{OUT} = 1mA$  |       | 0.85  | 1     | V          |
|   | Minimum Operating Voltage            | $V_{SHDN} = V_{IN}$  |       | 0.5   | 0.65  |            |
| $V_{OUT}$   | Output Voltage Range                 |  | 2.5   |       | 5.5   | V          |
|   | Output Voltage Accuracy <sup>3</sup> | $I_{OUT} = 10mA$ ; $T_A = -40^\circ C$ to $+85^\circ C$          | -4    |       | +4    | %          |
| $V_{FB}$  | Reference Voltage                    | $T_A = -40^\circ C$ to $+85^\circ C$                             | 1.192 | 1.230 | 1.268 | V          |
| $\frac{\Delta V_{OUT}}{V_{OUT}} / \frac{\Delta V_{IN}}{V_{IN}}$   | Reference Voltage Line Regulation    | $V_{IN} = 1.2V$ to $2.4V$ , $I_{OUT} = 10mA$ , $V_{OUT} = 3.3V$  |       | 0.2   |       | % / V      |
|   |                                      | $V_{IN} = 2.4V$ to $4.2V$ , $I_{OUT} = 10mA$ , $V_{OUT} = 5.0V$  |       | 0.4   |       |            |
| $\frac{\Delta V_{OUT}}{V_{OUT}} / \frac{\Delta I_{OUT}}{I_{OUT}}$ | Reference Voltage Load Regulation    | $V_{IN} = 1.2V$ , $I_{OUT} = 10mA$ to $100mA$ , $V_{OUT} = 3.3V$ |       | 0.003 |       | % / mA     |
|   |                                      | $V_{IN} = 3.6V$ , $I_{OUT} = 10mA$ to $400mA$ , $V_{OUT} = 5.0V$ |       | 0.004 |       |            |
| $I_Q$   | Quiescent Current (Shutdown)         | $V_{SHDN} = 0$   |       | 0.01  | 1     | $\mu A$    |
|   | Quiescent Current (Active)           | Measured on $V_{OUT}$ , $V_{SHDN} = V_{IN}$                      |       | 300   | 500   |            |
| $I_{LN MOS}$  | NMOS Switch Leakage                  | $V_{SW} = 5V$  |       | 0.1   | 5     | $\mu A$    |
| $I_{LP MOS}$  | PMOS Switch Leakage                  | $V_{SW} = 0V$  |       | 0.1   | 5     | $\mu A$    |
| $R_{DS(ON)L}$   | NMOS Switch ON Resistance            | $V_{OUT} = 3.3V$   |       | 0.35  |       | $\Omega$   |
|   |                                      | $V_{OUT} = 5V$   |       | 0.30  |       |            |
| $R_{DS(ON)H}$   | PMOS Switch ON Resistance            | $V_{OUT} = 3.3V$   |       | 0.60  |       | $\Omega$   |
|   |                                      | $V_{OUT} = 5V$   |       | 0.55  |       |            |
| $I_{CL}$  | NMOS Current Limit                   |  | 750   | 1200  |       | mA         |
| $\Delta t(I_{CL})$  | Current Limit Delay to Output        |  |       | 40    |       | ns         |
| $D_{MAX}$   | Maximum Duty Cycle                   | $V_{FB} = 1.15V$ , $T_A = -40^\circ C$ to $+85^\circ C$          | 80    | 85    |       | %          |
| $F_{OSC}$   | Switching Frequency                  | $T_A = -40^\circ C$ to $+85^\circ C$                             | 0.9   | 1.2   | 1.5   | MHz        |
|   |                                      |  |       |       |       |            |
| $V_{SHDN}$  | SHDN Input Low                       |  |       |       | 0.35  | V          |
|   | SHDN Input High                      |  | 1.00  |       |       |            |
| $I_{SHDN}$  | SHDN Input Current                   | $V_{SHDN} = 5.5V$  |       | 0.01  | 1     | $\mu A$    |
| $T_{SD}$  | Thermal Shutdown                     |  |       | 160   |       | $^\circ C$ |
|   |                                      | Hysteresis   |       | 20    |       |            |

1. Specifications over the temperature range are guaranteed by design, characterization, and correlation with statistical process controls.

2. Not including the current into internal resistance divider.

3. For fixed 3.3V and 5.0V output voltage version. The adjustable output voltage is guaranteed by reference voltage accuracy.

## Typical Characteristics

**Efficiency vs. Output Current**

( $V_{OUT} = 3.3V$ ;  $T_A = 25^\circ C$ )

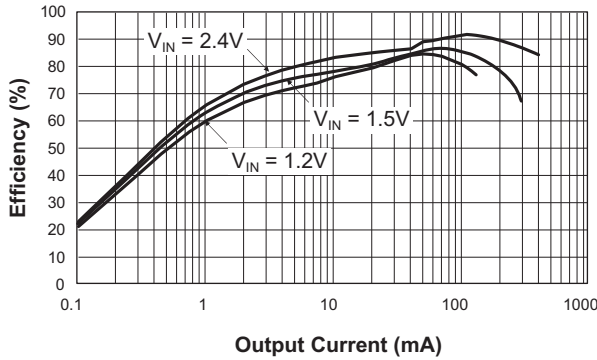

**Efficiency vs. Output Current**

( $V_{OUT} = 5V$ ;  $T_A = 25^\circ C$ )

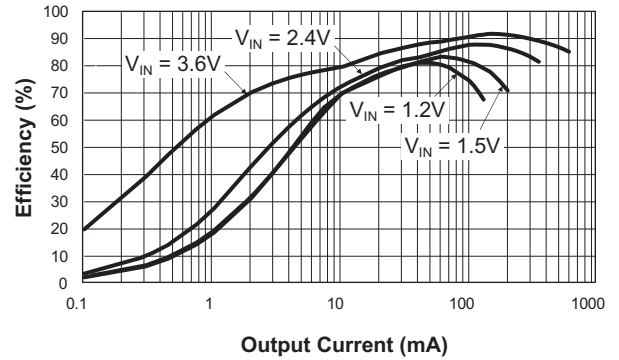

**Output Voltage vs. Output Current**

( $V_{OUT} = 3.3V$ ;  $T_A = 25^\circ C$ )

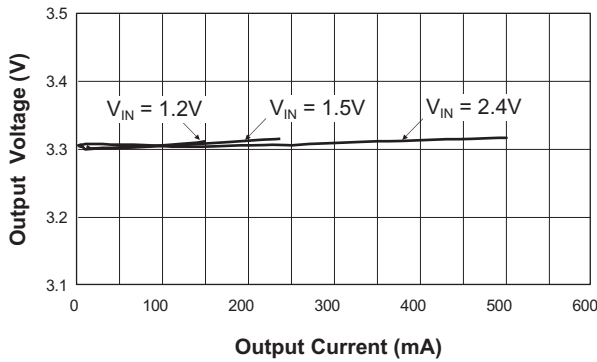

**Output Voltage vs. Output Current**

( $V_{OUT} = 5V$ ;  $T_A = 25^\circ C$ )

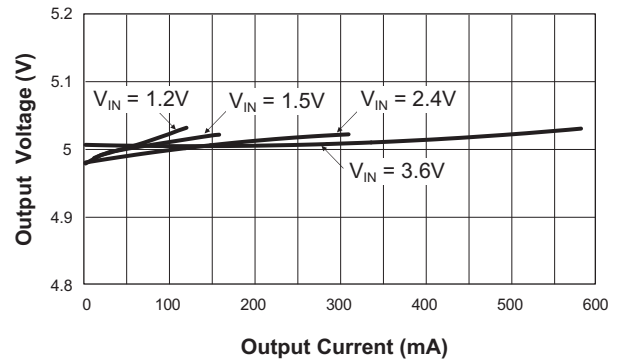

**Minimum Start-Up Voltage vs. Output Current**

( $V_{OUT} = 3.3V$ ;  $T_A = 25^\circ C$ )

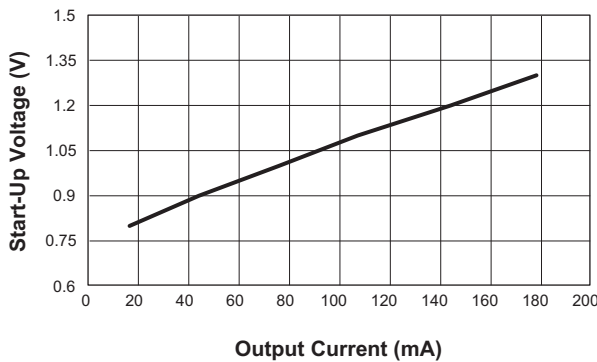

**Maximum Output Current vs. Input Voltage**

( $L = 4.7\mu H$ ;  $T_A = 25^\circ C$ )

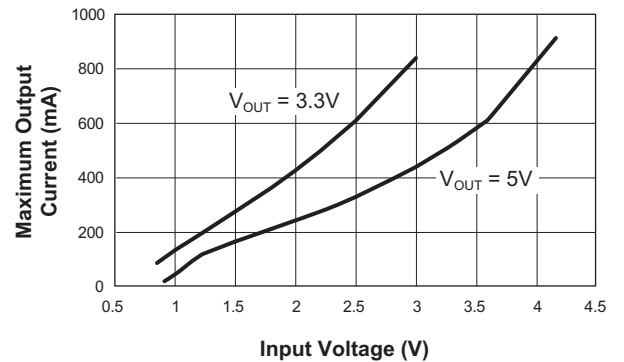

## Typical Characteristics

**No Load Input Current vs. Input Voltage**  
( $V_{OUT} = 3.3V$ ;  $T_A = 25^\circ C$ ; No Load)

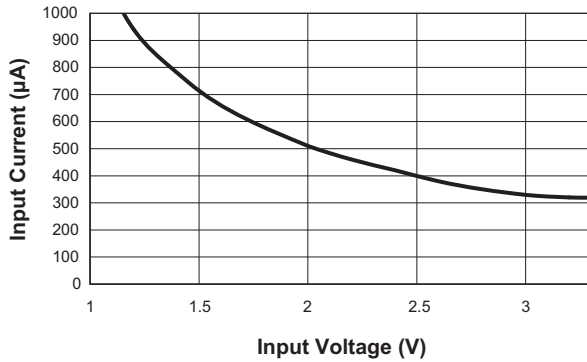

**Output Voltage vs. Temperature**

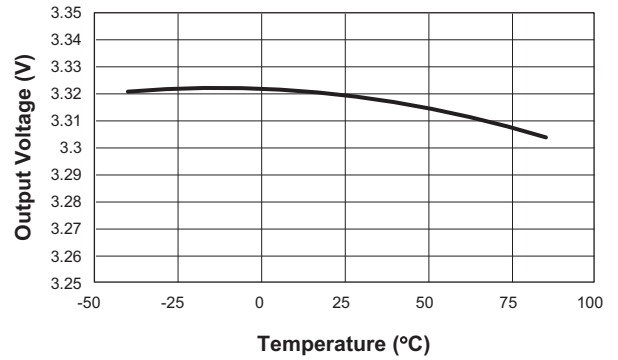

**Light Load Mode Operation**  
( $V_{IN} = 1.8V$ ;  $V_{OUT} = 3.3V$ ;  $I_{OUT} = 5mA$ )

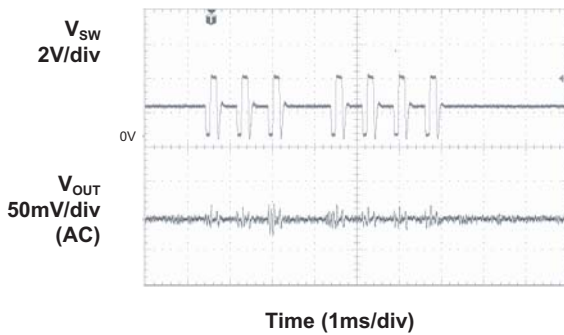

**Anti-Ringing Operation at SW**  
( $V_{IN} = 2.4V$ ;  $V_{OUT} = 5V$ ;  $I_{OUT} = 20mA$ )

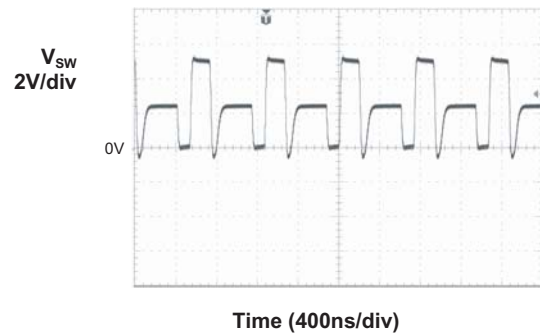

**Load Transient Response**  
( $V_{IN} = 1.5V$ ;  $V_{OUT} = 3.3V$ ;  $C_{FF} = 100pF$ )

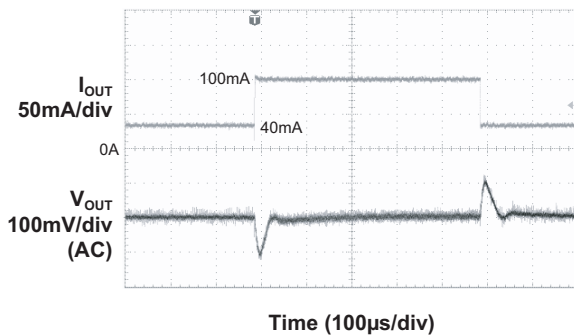

## Functional Block Diagram

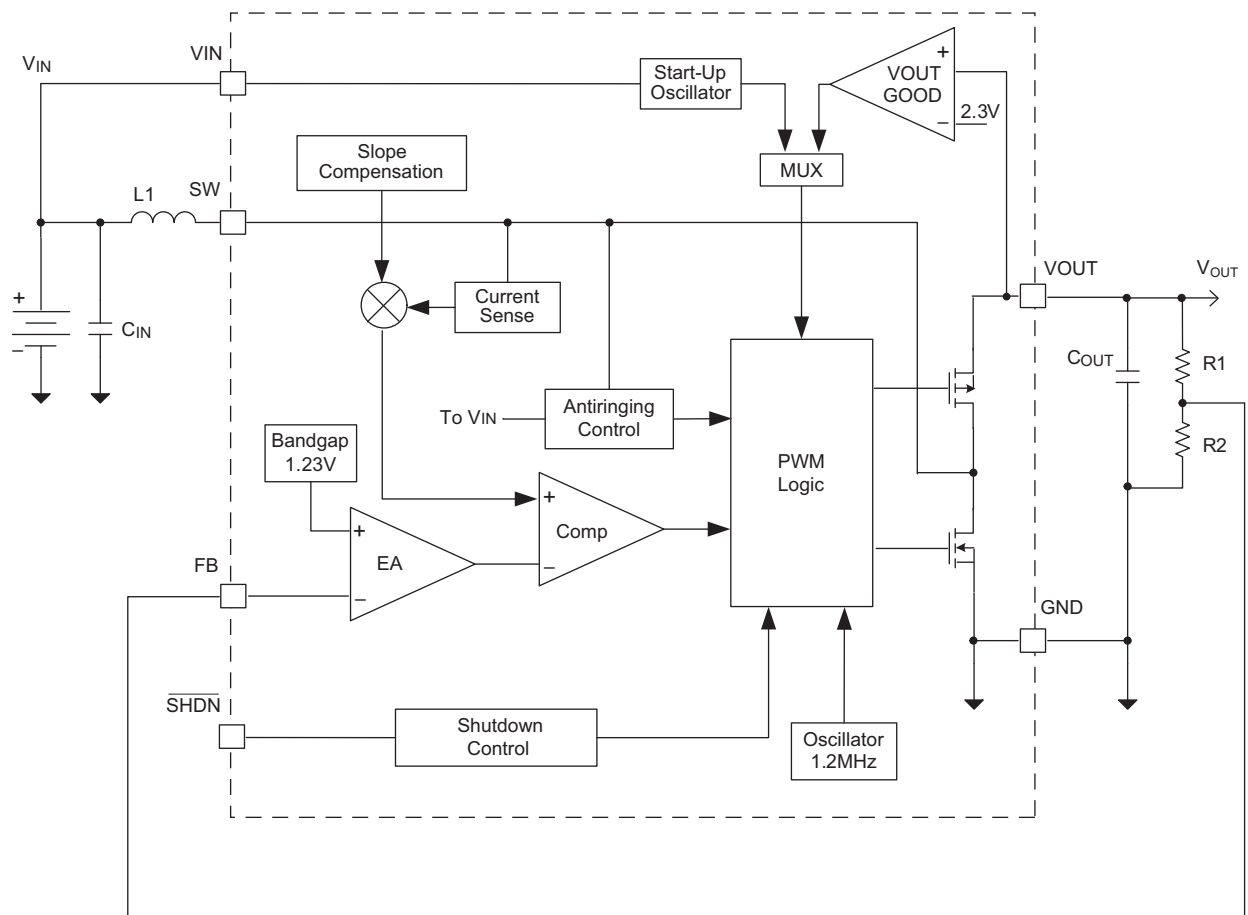

## Functional Description

The AAT1217 is a synchronous step-up DC-DC converter. It utilizes internal MOSFET switches to achieve high efficiency over the full load current range. It operates at a fixed switching frequency of 1.2MHz, and uses the slope compensated current mode pulse width modulation (PWM) architecture. The device can operate with an input voltage below 1V; the typical start-up voltage is 0.85V.

## Synchronous Rectification

The AAT1217 integrates a synchronous rectifier to improve efficiency as well as to eliminate the need for an external Schottky diode. The synchronous rectifier is used to reduce the conduction loss contributed by the forward voltage of an external Schottky diode. The synchronous

rectifier is realized by a P-channel MOSFET (PMOS) with gate control circuitry that incorporates relatively complicated timing concerns. An external Schottky diode is required when the output voltage is greater than 4.5V.

## Low Voltage Start-Up

The AAT1217 can start-up with supply voltages down to 0.85V. During start-up, the internal low voltage start-up circuitry controls the internal NMOS switch. The AAT1217 leaves the start-up mode once  $V_{OUT}$  exceeds 2.3V. An internal comparator (VOUT GOOD) monitors the output voltage and places the chip into normal operation once  $V_{OUT}$  exceeds 2.3V. The AAT1217's control circuitry is biased by  $V_{IN}$  during start-up and biased by  $V_{OUT}$  once  $V_{OUT}$  exceeds  $V_{IN}$ . When  $V_{OUT}$  exceeds  $V_{IN}$ , the AAT1217's operation will be independent of  $V_{IN}$ .

## Current Mode Operation

The AAT1217 is based on a slope compensated current mode PWM control topology. It operates at a fixed frequency of 1.2MHz. At the beginning of each clock cycle, the main switch (NMOS) is turned on and the inductor current starts to ramp. After the maximum duty cycle or the sense current signal equals the error amplifier (EA) output, the main switch is turned off and the synchronous switch (PMOS) is turned on. This control topology features cycle-by-cycle current limiting which can prevent the main switch from overstress and the external inductor from saturating.

## Light Load Mode Operation

At very light load, the AAT1217 automatically switches into light load mode operation to improve efficiency. During this mode, the PWM control will skip some pulses to maintain regulation. If the load increases and the output voltage drops, the device will automatically switch back to normal PWM mode and maintain regulation.

## Anti-Ringing Control

An anti-ringing circuitry is included to remove the high frequency ringing that appears on the SW pin when the inductor current goes to zero. In this case, a ringing on the SW pin is induced due to remaining energy stored in parasitic components of switch and inductor. The anti-ringing circuitry clamps the voltage internally to the battery voltage and therefore dampens this ringing.

## Device Shutdown

When  $\overline{\text{SHDN}}$  is set logic high, the AAT1217 is put into active mode operation. If  $\overline{\text{SHDN}}$  is set logic low, the device is put into shutdown mode and consumes less than 1 $\mu$ A of current. After start-up, the internal circuitry is supplied by  $V_{\text{OUT}}$ , however, if shutdown mode is enabled, the internal circuitry will be supplied by the input source again.

## Application Information

### Adjustable Output Voltage

An external resistor divider is used to set the output voltage. The output voltage of the switching regulator ( $V_{\text{OUT}}$ ) is determined by the following equation:

$$V_{\text{OUT}} = 1.23\text{V} \cdot \left(1 + \frac{R1}{R2}\right)$$

Table 1 lists the recommended resistor values for particular output voltage settings.

| $V_{\text{OUT}}$ | R1( $\Omega$ ) | R2( $\Omega$ ) |
|------------------|----------------|----------------|
| 3.3V             | 1.02M          | 604k           |
| 5.0V             | 1.02M          | 332k           |

**Table 1: Resistor Selection for Output Voltage Setting.**

### Fixed Output Voltage

The AAT1217 has two fixed output voltage options: 3.3V and 5V. An internal resistor divider is connected to the FB pin inside the package which eliminates the need for external feedback resistors. When designing with the fixed output voltage option, remember to leave the FB pin open; otherwise the output voltage will be affected. However, a feed-forward capacitor can still be added between the FB and VOUT pins to enhance the control loop performance.

### Inductor Selection

The high switching frequency of 1.2MHz allows for small surface mount inductors. For most applications, the AAT1217 operates with inductors from 2.2 $\mu$ H to 10 $\mu$ H. Use the following equations to select the proper inductor value for a particular application condition:

$$I_{\text{PEAK}} = I_{\text{DC}} + \frac{\Delta I_L}{2}$$

$$I_{\text{DC}} = \frac{I_{\text{OUT}} \cdot V_{\text{OUT}}}{\eta \cdot V_{\text{IN}}}$$

$$\Delta I_L = \frac{V_{\text{IN}} \cdot D}{L \cdot F_{\text{SW}}}; D = \frac{V_{\text{OUT}} - V_{\text{IN}}}{V_{\text{OUT}}}$$

$$\Delta I_L = \frac{V_{\text{IN}} \cdot (V_{\text{OUT}} - V_{\text{IN}})}{L \cdot F_{\text{SW}} \cdot V_{\text{OUT}}}$$



$$I_{PEAK} = \frac{I_{OUT} \cdot V_{OUT}}{\eta \cdot V_{IN}} + \frac{V_{IN} \cdot (V_{OUT} - V_{IN})}{2L \cdot F_{SW} \cdot V_{OUT}}$$

- $I_{PEAK}$  Peak Inductor Current
- $I_{DC}$  DC Component (Average) of the Inductor Current
- $\Delta I_L$  Peak-Peak Inductor Ripple Current
- $I_{OUT}$  Output (Load) Current
- $V_{OUT}$  Output Voltage
- $V_{IN}$  Input Voltage
- $\eta$  AAT1217 Efficiency (consult the performance graphs in the "Typical Characteristics" section of the data sheet)
- D Steady-State Duty Cycle
- $F_{SW}$  Switching Frequency
- L Inductor Value

For a given chosen inductor value and application conditions make sure the peak inductor current does not exceed the maximum current rating of the selected vendor's inductor. For optimum load transient and efficiency, low DCR inductors should be selected. Table 2 lists some typical surface mount inductors that are suitable for typical AAT1217 applications.

### Input Capacitor

A surface mount 4.7 $\mu$ F or greater, X5R or X7R, ceramic capacitor is suggested for the input capacitor. The input capacitor provides a low impedance loop for the edges of pulsed current drawn by the AAT1217. Low ESR/ESL

X7R and X5R ceramic capacitors are ideal for this function. To minimize stray inductance, the capacitor should be placed as close as possible to the IC. This keeps the high frequency content of the input current localized, minimizing EMI and input voltage ripple. Always examine the ceramic capacitor DC voltage coefficient characteristics to get the proper value. For example, the capacitance of a 10 $\mu$ F, 6.3V, X5R ceramic capacitor with 5.0V DC applied is actually about 6 $\mu$ F.

A laboratory test set-up typically consists of two long wires running from the bench power supply to the evaluation board input voltage pins. The inductance of these wires, along with the low-ESR ceramic input capacitor, can create a high Q network that may affect converter performance. This problem often becomes apparent in the form of excessive ringing in the output voltage during load transients which can produce errors in loop phase and gain measurements. Since the inductance of a short printed circuit board (PCB) trace feeding the input voltage is significantly lower than the power leads from the bench power supply, most actual applications do not exhibit this problem. In applications where the input power source lead inductance cannot be reduced to a level that does not affect the converter performance, a high ESR tantalum or aluminum electrolytic capacitor should be placed in parallel with the low ESR, ESL bypass input ceramic capacitor. The introduction of the high ESR capacitor dampens the high Q network and stabilizes the AAT1217.

| Part Number        | L ( $\mu$ H) | Max DCR ( $m\Omega$ ) | Rated DC Current (A) | Size WxLxH (mm) |
|--------------------|--------------|-----------------------|----------------------|-----------------|
| Sumida CDH28D11/S  | 2.2          | 123                   | 1.15                 | 3x3.3x1.2       |
|                    | 4.7          | 238                   | 0.75                 |                 |
|                    | 10           | 431                   | 0.53                 |                 |
| Coiltronics SD3112 | 2.2          | 140 (typ)             | 1.12                 | 3.1x3.1x1.2     |
|                    | 4.7          | 246 (typ)             | 0.8                  |                 |
|                    | 10           | 446 (typ)             | 0.55                 |                 |
| TDK VLF3012A       | 2.2          | 100                   | 1                    | 2.8x2.6x1.2     |
|                    | 4.7          | 190                   | 0.74                 |                 |
|                    | 10           | 410                   | 0.49                 |                 |
| Sumida CR43        | 2.2          | 71.2                  | 1.75                 | 4.3x4.8x3.5     |
|                    | 4.7          | 108.7                 | 1.15                 |                 |
|                    | 10           | 182                   | 1.04                 |                 |
| Sumida CDRH4D28    | 2.2          | 31.3                  | 2.04                 | 5.0x5.0x3.0     |
|                    | 4.7          | 72                    | 1.32                 |                 |
|                    | 10           | 128                   | 1                    |                 |
| Toko D53LC         | 4.7          | 45                    | 1.87                 | 5.0x5.0x3.0     |
|                    | 10           | 90                    | 1.33                 |                 |

**Table 2: Typical Surface Mount Inductors.**

**Output Capacitor**

The output capacitor limits the output ripple and provides holdup during large load transitions. A 4.7 $\mu$ F to 10 $\mu$ F, X5R or X7R, ceramic capacitor is suggested for the output capacitor. Typically the recommended capacitor range provides sufficient bulk capacitance to stabilize the output voltage during large load transitions and has the ESR and ESL characteristics necessary for low output voltage ripple.

In addition, the output voltage droop during load transient is dominated by the capacitance of the ceramic output capacitor. During a step increase in load current, the ceramic output capacitor alone supplies the load current until the loop responds. Within several switching cycles, the loop responds and the inductor current increases to match the load current demand. Larger output capacitor values help to reduce the voltage droop during large load current transients.

**External Diode Selection**

An external Schottky diode is required when the output voltage is above 4.5V. The Schottky diode is optional for output voltages  $\leq$  4.5V, but can improve efficiency by about 2% to 3%.

**Load Disconnect in Shutdown**

In conventional synchronous step-up converters, a conduction path exists from input to output through the backgate (body diode) of the P-channel MOSFET during shutdown. Special application circuitry can disconnect the load from the battery during shutdown (see Figure 1).

**PCB Layout Guidance**

The AAT1217 typically operates at 1.2MHz. This is a considerably high frequency for DC-DC converters. PCB layout is important to guarantee satisfactory performance. It is recommended to make traces of the power loop, especially where the switching node is involved, as short and wide as possible. First of all, the inductor, input and output capacitor should be as close as possible to the device. Feedback and shutdown circuits should avoid the proximity of large AC signals involving the power inductor and switching node. The optional rectifier diode (D1 in Figure 1) can improve efficiency and alleviate the stress on the integrated MOSFETs. The diode should also be close to the inductor and the chip to form the shortest possible switching loop. While the two-layer PCB shown in Figures 2 and 3 is enough for most applications, large and integral multi-layer ground planes are ideal for high power applications. Large areas of copper have lower resistance and help to dissipate heat. The converter's ground should join the system ground to which it supplies power at one point only. Figure 1 is the schematic for a highly efficient load disconnect application circuit for the AAT1217. An example PCB layout for the AAT1217 is shown in Figures 2 and 3.

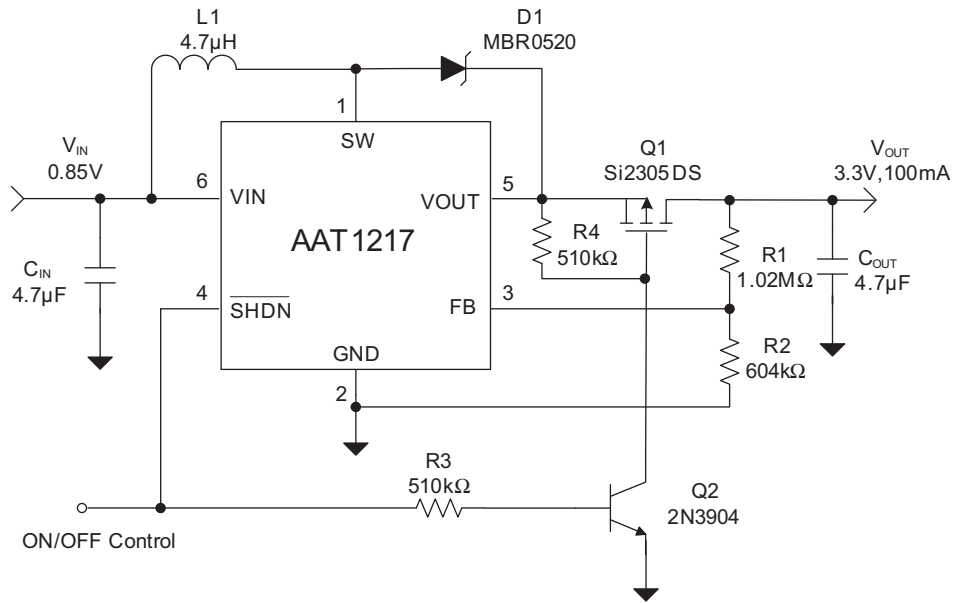

**Figure 1: AAT1217 High Efficiency Load Disconnect Application Circuit.**

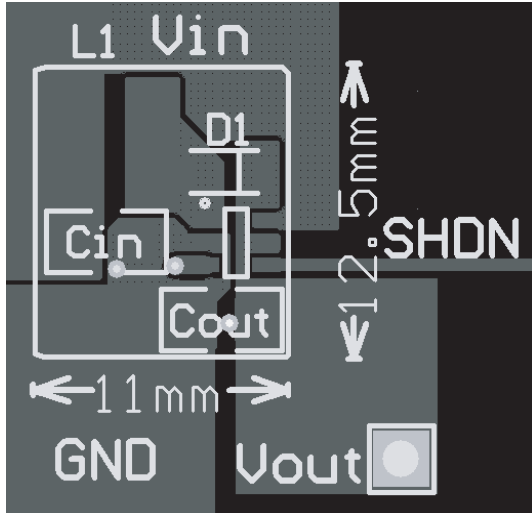

**Figure 2: AAT1217 Evaluation Board Layout Example Top Layer.**

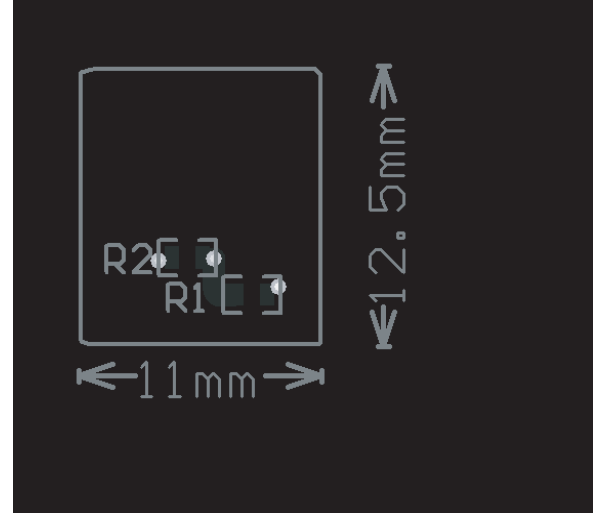

**Figure 3: AAT1217 Evaluation Board Layout Example Bottom Layer.**

## Ordering Information

| Output Voltage <sup>1</sup> | Package  | Marking <sup>2</sup> | Part Number (Tape and Reel) <sup>3</sup> |
|-----------------------------|----------|----------------------|--|
| Adj.                        | TSOT23-6 | VZMY                 | <b>AAT1217ICA-1.2-T1</b>                 |
| Fixed 3.3V                  | TSOT23-6 | WAMY                 | <b>AAT1217ICA-3.3-T1</b>                 |
| Fixed 5.0V                  | TSOT23-6 | WBMY                 | <b>AAT1217ICA-5.0-T1</b>                 |
| Fixed 3.3V                  | SOT23-6  | 3CXY                 | <b>AAT1217IGU-3.3-T1</b>                 |



All AnalogicTech products are offered in Pb-free packaging. The term "Pb-free" means semiconductor products that are in compliance with current RoHS standards, including the requirement that lead not exceed 0.1% by weight in homogeneous materials. For more information, please visit our website at <http://www.analogictech.com/about/quality.aspx>.

## Package Information

### TSOT23-6

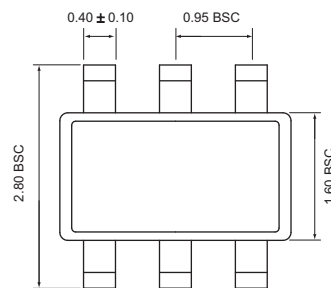

Top View

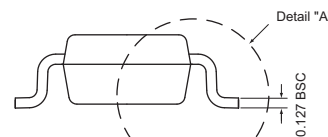

End View

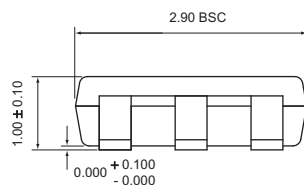

Side View

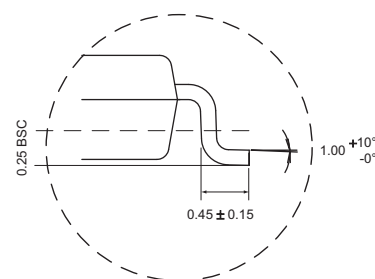

Detail "A"

All dimensions in millimeters.

1. Please contact sales for other voltage options.
2. YY = Manufacturing Date Code.
3. Sample stock is generally held on part numbers listed in **BOLD**.

**SOT23-6**

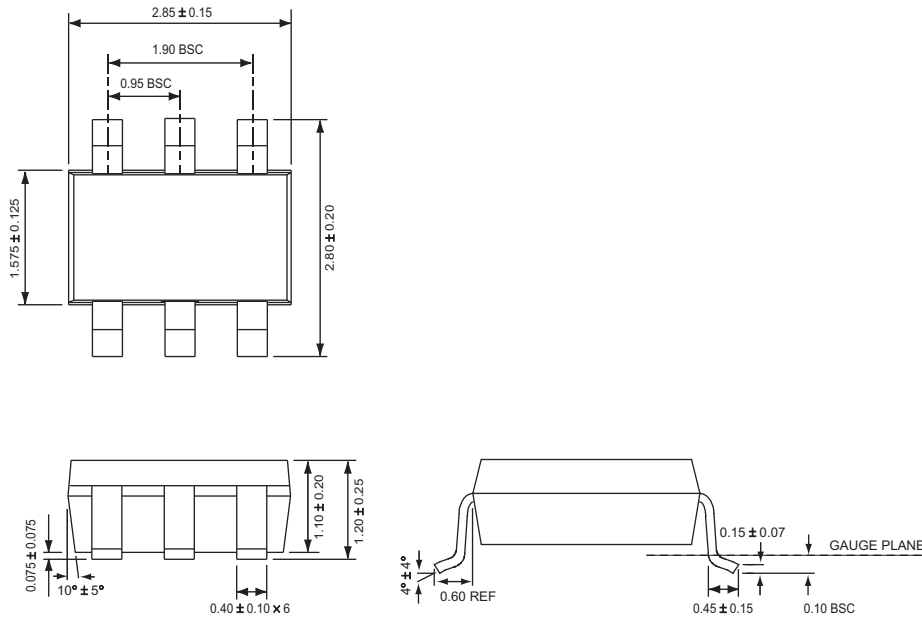

All dimensions in millimeters.

**Advanced Analogic Technologies, Inc.**  
 3230 Scott Boulevard, Santa Clara, CA 95054  
 Phone (408) 737-4600  
 Fax (408) 737-4611



© Advanced Analogic Technologies, Inc. AnalogicTech cannot assume responsibility for use of any circuitry other than circuitry entirely embodied in an AnalogicTech product. No circuit patent licenses, copyrights, mask work rights, or other intellectual property rights are implied. AnalogicTech reserves the right to make changes to their products or specifications or to discontinue any product or service without notice. Except as provided in AnalogicTech's terms and conditions of sale, AnalogicTech assumes no liability whatsoever, and AnalogicTech disclaims any express or implied warranty relating to the sale and/or use of AnalogicTech products including liability or warranties relating to fitness for a particular purpose, merchantability, or infringement of any patent, copyright or other intellectual property right. In order to minimize risks associated with the customer's applications, adequate design and operating safeguards must be provided by the customer to minimize inherent or procedural hazards. Testing and other quality control techniques are utilized to the extent AnalogicTech deems necessary to support this warranty. Specific testing of all parameters of each device is not necessarily performed. AnalogicTech and the AnalogicTech logo are trademarks of Advanced Analogic Technologies Incorporated. All other brand and product names appearing in this document are registered trademarks or trademarks of their respective holders.



Компания «ЭлектроПласт» предлагает заключение долгосрочных отношений при поставках импортных электронных компонентов на взаимовыгодных условиях!

Наши преимущества:

- Оперативные поставки широкого спектра электронных компонентов отечественного и импортного производства напрямую от производителей и с крупнейших мировых складов;
- Поставка более 17-ти миллионов наименований электронных компонентов;
- Поставка сложных, дефицитных, либо снятых с производства позиций;
- Оперативные сроки поставки под заказ (от 5 рабочих дней);
- Экспресс доставка в любую точку России;
- Техническая поддержка проекта, помощь в подборе аналогов, поставка прототипов;
- Система менеджмента качества сертифицирована по Международному стандарту ISO 9001;
- Лицензия ФСБ на осуществление работ с использованием сведений, составляющих государственную тайну;
- Поставка специализированных компонентов (Xilinx, Altera, Analog Devices, Intersil, Interpoint, Microsemi, Aeroflex, Peregrine, Syfer, Eurofarad, Texas Instrument, Miteq, Cobham, E2V, MA-COM, Hittite, Mini-Circuits, General Dynamics и др.);

Помимо этого, одним из направлений компании «ЭлектроПласт» является направление «Источники питания». Мы предлагаем Вам помощь Конструкторского отдела:

- Подбор оптимального решения, техническое обоснование при выборе компонента;
- Подбор аналогов;
- Консультации по применению компонента;
- Поставка образцов и прототипов;
- Техническая поддержка проекта;
- Защита от снятия компонента с производства.



#### Как с нами связаться

**Телефон:** 8 (812) 309 58 32 (многоканальный)

**Факс:** 8 (812) 320-02-42

**Электронная почта:** [org@eplast1.ru](mailto:org@eplast1.ru)

**Адрес:** 198099, г. Санкт-Петербург, ул. Калинина, дом 2, корпус 4, литера А.