

## GENERAL SPECIFICATIONS FOR S1 ~ S29

A  
Toggles

### Electrical Capacity (Resistive & Inductive Load)

**Power Level:** Shown in the following tables

### Other Ratings

**Contact Resistance:** 10 milliohms maximum  
**Insulation Resistance:** 1,000 megohms minimum @ 500V DC  
**Dielectric Strength:** 2,000V AC minimum for 1 minute minimum  
**Mechanical Life:** 30,000 operations minimum for S5AW, S8AW, S9AW, S25AW, S28AW, S29AW  
 50,000 operations minimum for all other models  
**Electrical Life:** 25,000 operations minimum  
**Angle of Throw ( $\alpha$ ):** Shown in tables on following pages

### Materials & Finishes

**Toggle:** Brass with chrome plating  
**Bushing:** Brass with chrome plating  
**Case:** Phenolic resin  
**Case Cover:** Steel with zinc plating  
**Movable Contactor:** Copper with silver plating  
**Movable Contacts:** Silver alloy capped on copper with silver plating  
**Stationary Contacts:** Silver alloy capped on copper with silver plating  
**Terminals:** Brass with tin plating

### Environmental Data

**Operating Temp Range:** -30°C through +70°C (-22°F through +158°F) for Splashproof models;  
 -10°C through +70°C (+14°F through +158°F) for all other models  
**Sealing:** Splashproof & lever lock panel seal models meet IP67 standard

### Installation

**Mounting Torque:** 1.47Nm (13 lb•in) for single nut on AW & AL models  
 2.94Nm (26 lb•in) for double nut on other models  
**Maximum Panel Thickness:** Shown beneath panel cutout in switch dimension drawings  
**Soldering Time & Temperature:** Manual Soldering: See Profile A in Supplement section.

### Standards & Certifications

**UL:** **File No. E44145 - Recognized only when ordered with marking on switch.**  
 Add "/U" or "/CUL" to end of part number to order UL recognized switch.  
 UL or cULus recognition designated beside part numbers on following pages.  
 See Supplement section to find UL or cULus rating details.

**CSA:** **File No. 023535\_0\_000 - Certified only when ordered with marking on switch.**  
 Add "/C" to end of part number to order CSA certified switch.  
 CSA certification designated beside part numbers on following pages.  
 See Supplement section to find CSA rating details.

Rockers

Pushbuttons

Illuminated PB

Programmable

Keylocks

Rotaries

Slides

Tactiles

Tilt

Touch

Indicators



Accessories

Supplement

Toggles  
A

## SINGLE POLE WITH SOLDER LUG \*

* UL, cULus & CSA recognized only when ordered with marking on switch (see General Specs)			Toggle Position/Connected Terminals						Electrical Capacity			
Model	* Approvals			Pole & Throw	Down	Center	Up	Resistive			Inductive	Angle of Throw
	UL	cULus	CSA		Keyway			AC 125V	AC 250V	DC 30V	AC 125V PF 0.6	
S1A	✓	✓	✓	SPST	ON 1-3	NONE	OFF —	15A	6A	20A	8A	25°
S2A	✓	✓	✓	SPDT	ON 2-3	NONE	ON 2-1	15A	6A	20A	8A	25°
S3A	✓	✓	✓	SPDT	ON 2-3	OFF	ON 2-1	15A	6A	20A	8A	25°

**Throw & Schematics:** SPST  INTERNAL CONNECTION SPDT 

Note: Terminal numbers are actually on the switch

**Notes:** Standard Hardware: AT504M Knurled Nut, AT508 Lockwasher, AT527M Backup Hex Nut. See Accessories & Hardware section.  
Optional Splashproof Boot Assemblies: AT401 & AT4181 boots plus hex nut & o-ring. See Accessories & Hardware section.

\* Wire harness & cable assemblies offered only in Americas.

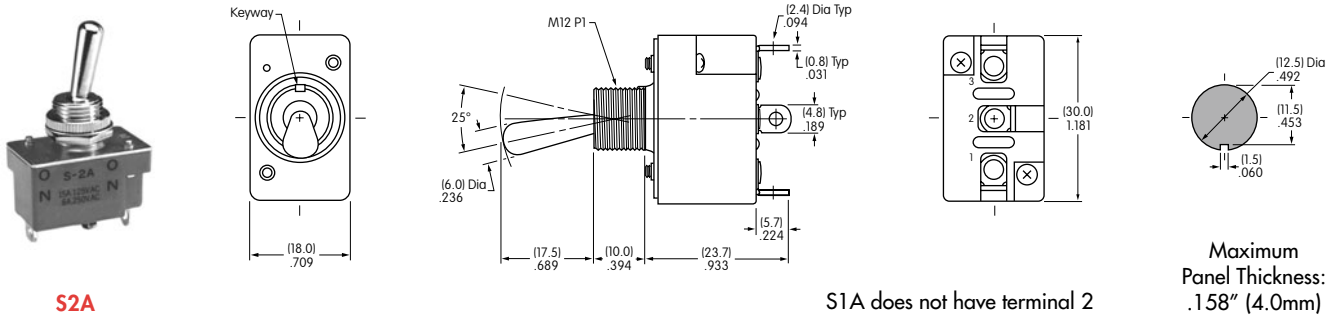

S2A

S1A does not have terminal 2

Maximum Panel Thickness: .158" (4.0mm)

## DOUBLE POLE WITH SOLDER LUG \*

* UL, cULus & CSA recognized only when ordered with marking on switch (see General Specs)			Toggle Position/Connected Terminals						Electrical Capacity			
Model	* Approvals			Pole & Throw	Down	Center	Up	Resistive			Inductive	$\alpha =$ Angle of Throw
	UL	cULus	CSA		Keyway			AC 125V	AC 250V	DC 30V	AC 125V PF 0.6	
S21A	—	—	—	DPST	ON 1-3 4-6	NONE	OFF —	15A	15A	15A	8A	21°
S6A	✓	✓	✓	DPDT	ON 2-3 5-6	NONE	ON 2-1 5-4	20A	10A	20A	8A	21°
S7A	—	—	✓	DPDT	ON 2-3 5-6	OFF	ON 2-1 5-4	20A	10A	20A	8A	28°

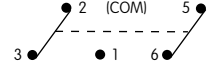
**Throw & Schematics:** DPST  INTERNAL CONNECTION DPDT 

Note: Terminal numbers are actually on the switch

**Notes:** Standard Hardware: AT504M Knurled Nut, AT508 Lockwasher, AT527M Backup Hex Nut. See Accessories & Hardware section.  
Optional Splashproof Boot Assemblies: AT401 & AT4181 boots plus hex nut & o-ring. See Accessories & Hardware section.

\* Wire harness & cables assemblies offered only in Americas.

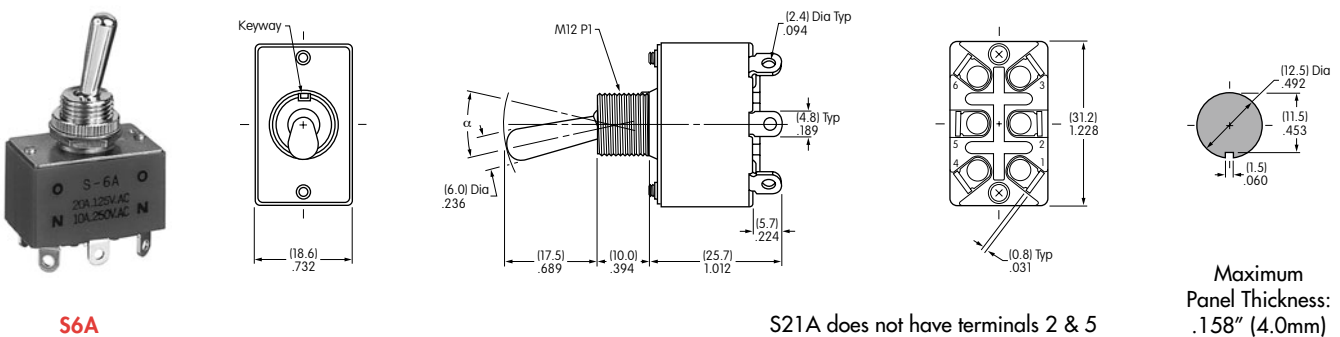

S6A

S21A does not have terminals 2 & 5

Maximum Panel Thickness: .158" (4.0mm)

Rockers

Pushbuttons

Pushbuttons

Pushbuttons

Pushbuttons

Pushbuttons

Keylocks

Rotaries

Slides

Tactiles

Tilt

Touch

Touch



Indicators



Accessories

Accessories

Supplement

## SINGLE POLE WITH QUICK CONNECT

Model	Approvals		Pole & Throw	Toggle Position/Connected Terminals				Electrical Capacity				Angle of Throw
	UL	SP		Down 	Center 	Up 	Resistive			Inductive		
							AC 125V	AC 250V	DC 30V	AC 125V PF 0.6		
S1F	—	—	SPST	ON 1-3	NONE	OFF —	15A	6A	20A	8A	25°	
S2F	—	—	SPDT	ON 2-3	NONE	ON 2-1	15A	6A	20A	8A	25°	
S3F	—	—	SPDT	ON 2-3	OFF	ON 2-1	15A	6A	20A	8A	25°	

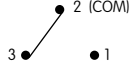

**Throw & Schematics:** SPST  INTERNAL CONNECTION  SPDT 

Note: Terminal numbers are actually on the switch

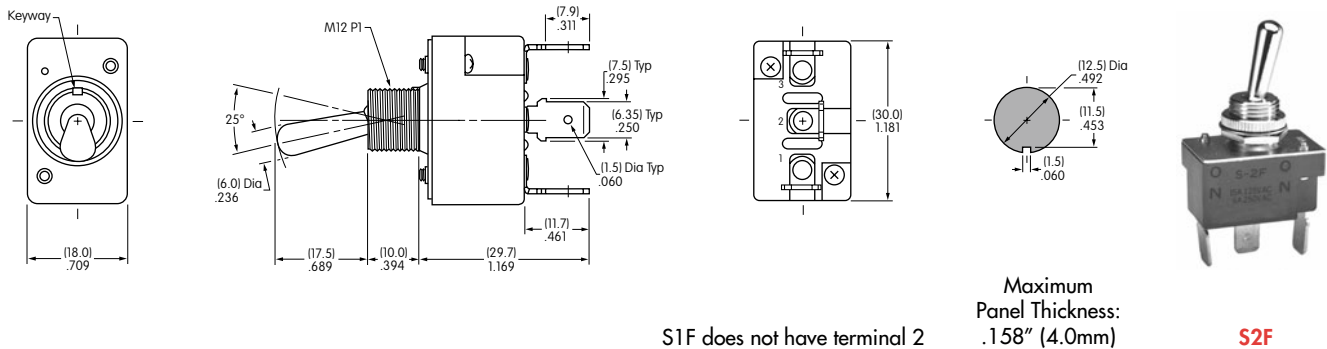
**Notes:** Standard Hardware: AT504M Knurled Nut, AT508 Lockwasher, AT527M Backup Hex Nut. See Accessories & Hardware section.  
Optional Splashproof Boot Assemblies: AT401 & AT4181 boots plus hex nut & o-ring. See Accessories & Hardware section.



## DOUBLE POLE WITH QUICK CONNECT

Model	Approvals		Pole & Throw	Toggle Position/Connected Terminals				Electrical Capacity				$\alpha$ = Angle of Throw
	UL	SP		Down 	Center 	Up 	Resistive			Inductive		
							AC 125V	AC 250V	DC 30V	AC 125V PF 0.6		
S21F	—	—	DPST	ON 1-3 4-6	NONE	OFF —	15A	15A	15A	8A	21°	
S6F	—	—	DPDT	ON 2-3 5-6	NONE	ON 2-1 5-4	20A	10A	20A	8A	21°	
S7F	—	—	DPDT	ON 2-3 5-6	OFF	ON 2-1 5-4	20A	10A	20A	8A	28°	

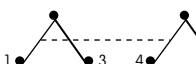
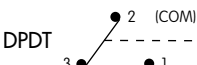
**Throw & Schematics:** DPST  INTERNAL CONNECTION 

Note: Terminal numbers are actually on the switch

**Notes:** Standard Hardware: AT504M Knurled Nut, AT508 Lockwasher, AT527M Backup Hex Nut. See Accessories & Hardware section.  
Optional Splashproof Boot Assemblies: AT401 & AT4181 boots plus hex nut & o-ring. See Accessories & Hardware section.

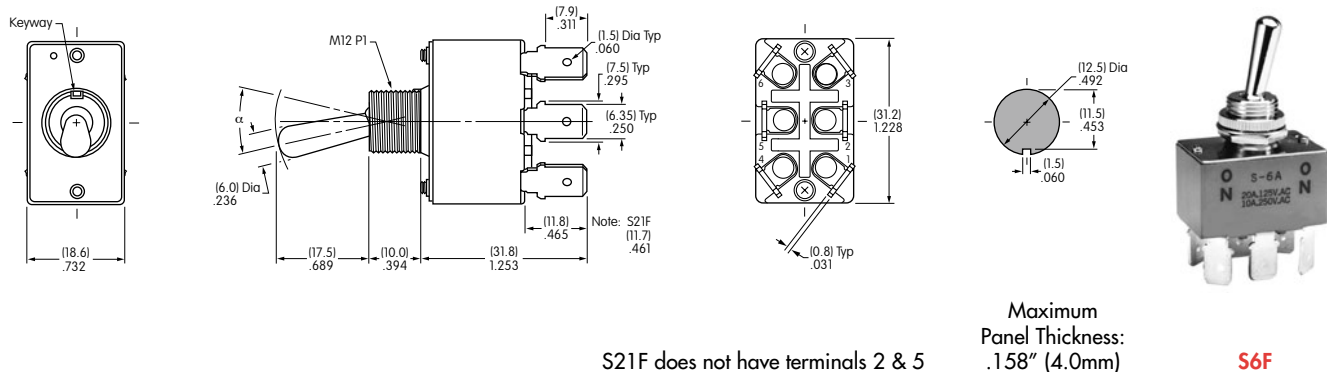

### SINGLE POLE SOLDER LUG WITH PANEL SEAL \*

Model	Approvals UL SP	Pole & Throw	Toggle Position/Connected Terminals ( ) = Momentary				Electrical Capacity			$\alpha$ = Angle of Throw
			Down Keyway	Center	Up	Resistive				
						AC 125V	AC 250V	DC 30V		
S1AW	—	SPST	ON 1-3	NONE	OFF —	15A	6A	20A	24°	
S2AW	—	SPDT	ON 2-3	NONE	ON 2-1	15A	6A	20A	24°	
S3AW	—	SPDT	ON 2-3	OFF	ON 2-1	15A	6A	20A	28°	
S5AW	—	SPDT	ON 2-3	NONE	(ON) 2-1	15A	6A	20A	20°	
S8AW	—	SPDT	(ON) 2-3	OFF	(ON) 2-1	15A	6A	20A	24°	
S9AW	—	SPDT	ON 2-3	OFF	(ON) 2-1	15A	6A	20A	24°	

**Throw & Schematics:** SPST  INTERNAL CONNECTION 

Note: Terminal numbers are actually on the switch

**Notes:** Standard Hardware: AT503M Face Hex Nut, AT508 Lockwasher, AT537 O-ring. See Accessories & Hardware section. For **.250" Quick Connect terminals**, add "F" to end of part number. See **Quick Connect terminal** dimensions on previous page. For further information, contact factory.

\* Wire harness & cable assemblies offered only in Americas.



S2AW

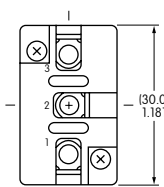
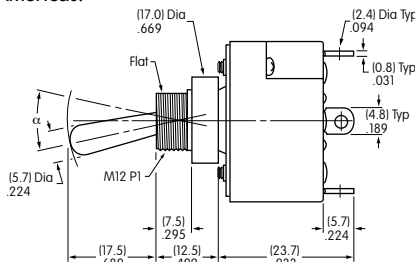
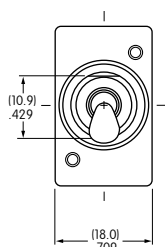

S1AW does not have terminal 2

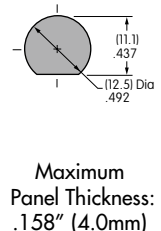

### DOUBLE POLE SOLDER LUG WITH PANEL SEAL \*

Model	Approvals UL SP	Pole & Throw	Toggle Position/Connected Terminals ( ) = Momentary				Electrical Capacity			$\alpha$ = Angle of Throw
			Down Keyway	Center	Up	Resistive				
						AC 125V	AC 250V	DC 30V		
S21AW	—	DPST	ON 1-3 4-6	NONE	OFF —	15A	15A	15A	22°	
S6AW	—	DPDT	ON 2-3 5-6	NONE	ON 2-1 5-4	20A	10A	20A	22°	
S7AW	—	DPDT	ON 2-3 5-6	OFF	ON 2-1 5-4	20A	10A	20A	28°	
S25AW	—	DPDT	ON 2-3 5-6	NONE	(ON) 2-1 5-4	15A	6A	20A	20°	
S28AW	—	DPDT	(ON) 2-3 5-6	OFF	(ON) 2-1 5-4	15A	6A	20A	22°	
S29AW	—	DPDT	ON 2-3 5-6	OFF	(ON) 2-1 5-4	15A	6A	20A	22°	

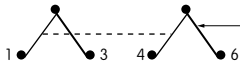
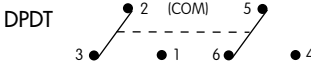
**Throw & Schematics:** DPST  INTERNAL CONNECTION 

Note: Terminal numbers are actually on the switch

**Notes:** Standard Hardware: AT503M Face Hex Nut, AT508 Lockwasher, AT537 O-ring. See Accessories & Hardware section. For **.250" Quick Connect terminals**, add "F" to end of part number. See **Quick Connect terminal** dimensions on previous page. For further information, contact factory.

\* Wire harness & cable assemblies offered only in Americas.



S6AW

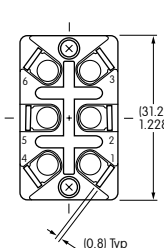
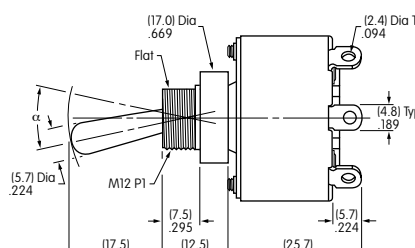
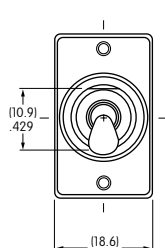

S21AW does not have terminals 2 & 5

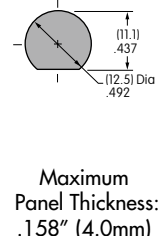

## SINGLE POLE SOLDER LUG WITH LOCKING LEVER & PANEL SEAL \*

Model	Approvals		Pole & Throw	Toggle Position/Connected Terminals				Electrical Capacity				$\alpha =$ Angle of Throw
	UL	cULus		Down Keyway	Center	Up	Resistive			Inductive		
							AC 125V	AC 250V	DC 30V	AC 125V PF 0.6		
S1AL	—	—	SPST	ON 1-3	NONE	OFF —	15A	6A	20A	8A	24°	
S2AL	—	—	SPDT	ON 2-3	NONE	ON 2-1	15A	6A	20A	8A	24°	
S3AL	—	—	SPDT	ON 2-3	OFF	ON 2-1	15A	6A	20A	8A	28°	

**Throw & Schematics:**

SPST: INTERNAL CONNECTION

SPDT: 2 (COM)

Note: Terminal numbers are actually on the switch

**Notes:** Standard Hardware: AT503M Face Hex Nut, AT508 Lockwasher, AT537 O-ring. See Accessories & Hardware section.

\* Wire harness & cable assemblies offered only in Americas.



## DOUBLE POLE SOLDER LUG WITH LOCKING LEVER & PANEL SEAL \*

Model	Approvals		Pole & Throw	Toggle Position/Connected Terminals				Electrical Capacity				$\alpha =$ Angle of Throw
	UL	cULus		Down Keyway	Center	Up	Resistive			Inductive		
							AC 125V	AC 250V	DC 30V	AC 125V PF 0.6		
S21AL	—	—	DPST	ON 1-3 4-6	NONE	OFF —	15A	15A	15A	8A	22°	
S6AL	✓	✓	DPDT	ON 2-3 5-6	NONE	ON 2-1 5-4	20A	10A	20A	8A	22°	
S7AL	—	—	DPDT	ON 2-3 5-6	OFF	ON 2-1 5-4	20A	10A	20A	8A	28°	

**Throw & Schematics:**

DPST: INTERNAL CONNECTION

DPDT: 2 (COM)

Note: Terminal numbers are actually on the switch

**Notes:** Standard Hardware: AT503M Face Hex Nut, AT508 Lockwasher, AT537 O-ring. See Accessories & Hardware section.

\* Wire harness & cable assemblies offered only in Americas.

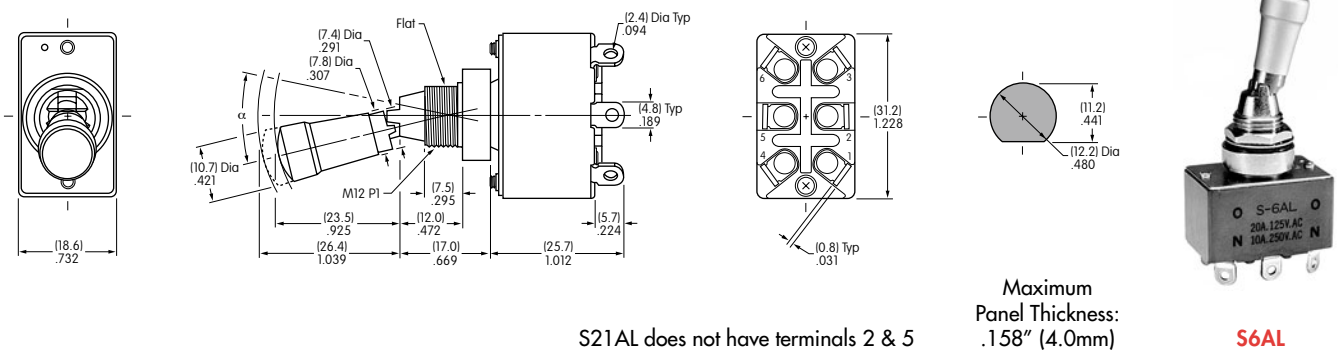

# Mouser Electronics

Authorized Distributor

Click to View Pricing, Inventory, Delivery & Lifecycle Information:

[NKK Switches:](#)

[S2A-RO](#) [S1A-RO](#) [S1F-RO](#) [S1AW-RO](#)



Компания «ЭлектроПласт» предлагает заключение долгосрочных отношений при поставках импортных электронных компонентов на взаимовыгодных условиях!

Наши преимущества:

- Оперативные поставки широкого спектра электронных компонентов отечественного и импортного производства напрямую от производителей и с крупнейших мировых складов;
- Поставка более 17-ти миллионов наименований электронных компонентов;
- Поставка сложных, дефицитных, либо снятых с производства позиций;
- Оперативные сроки поставки под заказ (от 5 рабочих дней);
- Экспресс доставка в любую точку России;
- Техническая поддержка проекта, помощь в подборе аналогов, поставка прототипов;
- Система менеджмента качества сертифицирована по Международному стандарту ISO 9001;
- Лицензия ФСБ на осуществление работ с использованием сведений, составляющих государственную тайну;
- Поставка специализированных компонентов (Xilinx, Altera, Analog Devices, Intersil, Interpoint, Microsemi, Aeroflex, Peregrine, Syfer, Eurofarad, Texas Instrument, Miteq, Cobham, E2V, MA-COM, Hittite, Mini-Circuits, General Dynamics и др.);

Помимо этого, одним из направлений компании «ЭлектроПласт» является направление «Источники питания». Мы предлагаем Вам помощь Конструкторского отдела:

- Подбор оптимального решения, техническое обоснование при выборе компонента;
- Подбор аналогов;
- Консультации по применению компонента;
- Поставка образцов и прототипов;
- Техническая поддержка проекта;
- Защита от снятия компонента с производства.



#### Как с нами связаться

**Телефон:** 8 (812) 309 58 32 (многоканальный)

**Факс:** 8 (812) 320-02-42

**Электронная почта:** [org@eplast1.ru](mailto:org@eplast1.ru)

**Адрес:** 198099, г. Санкт-Петербург, ул. Калинина, дом 2, корпус 4, литера А.