



DESCRIPTION

The popular 1N4565 thru 1N4584A-1 series of Zero-TC Reference Diodes provides a selection of both 6.4 V nominal voltages and temperature coefficients to as low as 0.0005%/°C for minimal voltage change with temperature. Four different operating currents are available for selection at 0.5 mA, 1.0 mA, 2.00 mA, and 4.00 mA. These glass axial-leaded DO-7 reference diodes are internal-metallurgical-bonded and are also available in JAN, JANTX, and JANTXV military qualifications. Microsemi also offers numerous other Zener Reference Diode products for a variety of other voltages up to 200 V.

APPEARANCE

**DO-7
(DO-204AA)**

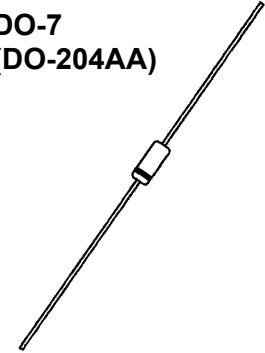

IMPORTANT: For the most current data, consult MICROSEMI's website: <http://www.microsemi.com>

FEATURES

- JEDEC registered 1N4565 thru 1N4584 series .
- Reference voltage diodes of nominal 6.4 V +/- 5% with tighter tolerance options available
- Temperature Coefficient range: 0.01%/°C to 0.0005%/°C.
- Zener Test Current selection range: 0.500 mA, 1.00 mA, 2.00 mA and 4.00 mA.
- Internal metallurgical bonded
- 1N4565 thru 1N4584 also have qualification to MIL-PRF-19500/452 by adding the JAN, JANTX, JANTXV, or JANS prefixes to part numbers as well as the "-1" suffix; e.g. JANTX1N4574A-1, etc.
- Military surface mount equivalents also available in DO-213AA by adding UR-1 suffix and the JAN, JANTX, and JANTXV prefix, e.g. JANTX1N4569AUR-1 (see separate data sheet)
- Also available in DO-35 package including military qualifications up to JANTXV (see separate data sheet)

APPLICATIONS / BENEFITS

- Provides minimal voltage change over a broad operating temperature range for instrumentation and other circuit designs requiring a voltage reference
- Temperature coefficient selections available from 0.01%/°C to 0.0005%/°C
- Tight reference voltage tolerances available with nominal value of 6.4 V by adding tolerance 1%, 2%, 3%, etc. after the part number for identification, e.g. 1N4569-2%, 1N4579A-1%, 1N4574A-1-1%, etc.
- Flexible axial-leaded mounting terminals
- Nonsensitive to ESD per MIL-STD-750 Method 1020

MAXIMUM RATINGS

- Operating Temperatures: -65°C to +175°C
- Storage Temperatures: -65°C to +175°C
- DC Power Dissipation: 500 mW @ T_L = 25°C with maximum current I_{ZM} 70 mA. NOTE: For optimum voltage-temperature stability, the operating test current (I_{ZT}) should be as specified in the Electrical Characteristics Table (power less than 30 mW)
- Solder Temperatures: 260°C for 10 s (max)

MECHANICAL AND PACKAGING

- CASE: Hermetically sealed glass case. DO-7 (DO-204AA) package
- TERMINALS: Leads, tin-lead plated solderable per MIL-STD-750, Method 2026
- MARKING: Part number and cathode band
- POLARITY: Reference diode to be operated with the banded end positive with respect to the opposite end
- TAPE & REEL option: Standard per EIA-296 (add "TR" suffix to part number)
- WEIGHT: 0.2 grams.
- See package dimensions on last page



1N4565(A)(-1) thru 1N4584(A)(-1) DO-7

***ELECTRICAL CHARACTERISTICS @ 25°C, unless otherwise specified**

JEDEC TYPE Number (Notes 1, 4 & 5)	ZENER TEST CURRENT (Note 3) I_{ZT} mA	MAXIMUM VOLTAGE TEMPERATURE COEFFICIENT			MAXIMUM REVERSE CURRENT $I_R @ 3 V$ μA	MAX. DYNAMIC IMPEDANCE (Note 2) $Z_{ZT} @ I_{ZT}$ OHMS
		$\alpha_{VZ} +/- \% / ^\circ C$	$+/- mV / ^\circ C$	Temp. Range		
1N4565	.5	.01	.64	0 to +75°C	2.0	200
1N4565A	.5	.01	.64	-55 to +100°C	2.0	200
1N4566	.5	.005	.32	0 to +75°C	2.0	200
1N4566A	.5	.005	.32	-55 to +100°C	2.0	200
1N4567	.5	.002	.13	0 to +75°C	2.0	200
1N4567A	.5	.002	.13	-55 to +100°C	2.0	200
1N4568	.5	.001	.06	0 to +75°C	2.0	200
1N4568A	.5	.001	.06	-55 to +100°C	2.0	200
1N4569	.5	.0005	.03	0 to +75°C	2.0	200
1N4569A	.5	.0005	.03	-55 to +100°C	2.0	200
1N4570	.5	.01	.64	0 to +75°C	2.0	100
1N4570A	.5	.01	.64	-55 to +100°C	2.0	100
1N4571	1.0	.005	.32	0 to +75°C	2.0	100
1N4571A	1.0	.005	.32	-55 to +100°C	2.0	100
1N4572	1.0	.002	.13	0 to +75°C	2.0	100
1N4572A	1.0	.002	.13	-55 to +100°C	2.0	100
1N4573	1.0	.001	.06	0 to +75°C	2.0	100
1N4573A	1.0	.001	.06	-55 to +100°C	2.0	100
1N4574	1.0	.0005	.03	0 to +75°C	2.0	100
1N4574A	1.0	.0005	.03	-55 to +100°C	2.0	100
1N4575	2.0	.01	.64	0 to +75°C	2.0	50
1N4575A	2.0	.01	.64	-55 to +100°C	2.0	50
1N4576	2.0	.005	.32	0 to +75°C	2.0	50
1N4576A	2.0	.005	.32	-55 to +100°C	2.0	50
1N4577	2.0	.002	.13	0 to +75°C	2.0	50
1N4577A	2.0	.002	.13	-55 to +100°C	2.0	50
1N4578	2.0	.001	.06	0 to +75°C	2.0	50
1N4578A	2.0	.001	.06	-55 to +100°C	2.0	50
1N4579	2.0	.0005	.03	0 to +75°C	2.0	50
1N4579A	2.0	.0005	.03	-55 to +100°C	2.0	50
1N4580	4.0	.01	.64	0 to +75°C	2.0	25
1N4580A	4.0	.01	.64	-55 to +100°C	2.0	25
1N4581	4.0	.005	.32	0 to +75°C	2.0	25
1N4581A	4.0	.005	.32	-55 to +100°C	2.0	25
1N4582	4.0	.002	.13	0 to +75°C	2.0	25
1N4582A	4.0	.002	.13	-55 to +100°C	2.0	25
1N4583	4.0	.001	.06	0 to +75°C	2.0	25
1N4583A	4.0	.001	.06	-55 to +100°C	2.0	25
1N4584	4.0	.0005	.03	0 to +75°C	2.0	25
1N4584A	4.0	.0005	.03	-55 to +100°C	2.0	25

*JEDEC Registered Data.

NOTES:

1. When ordering devices with tighter tolerances than specified for the V_Z voltage nominal of 6.40V, add a hyphenated suffix to the part number for desired tolerance, e.g. 1N4569A-2%, 1N4574A-1-1%, 1N4579-1-2%, 1N4584A-1-3%, etc.
2. Zener impedance is measured by superimposing 0.75 mA ac rms on 7.5 mA dc @ 25°C.
3. Voltage measurements to be performed 15 seconds after application of dc test current I_{ZT} .
4. 1N4565 thru 1N4584 also have qualification to MIL-PRF-19500/452 by adding the JAN, JANTX, JANTXV, or JANS prefixes to part numbers as well as the "-1" suffix; e.g. JANTX1N4569A-1, JANTXV1N4574A-1, etc.
5. Designate Radiation Hardened devices with "RH" prefix instead of "1N," i.e., RH4584A.



GRAPHS

Typical change of Temperature Coefficient with change in Operating Current

Typical Change in Zener Voltage with change in Operating Current

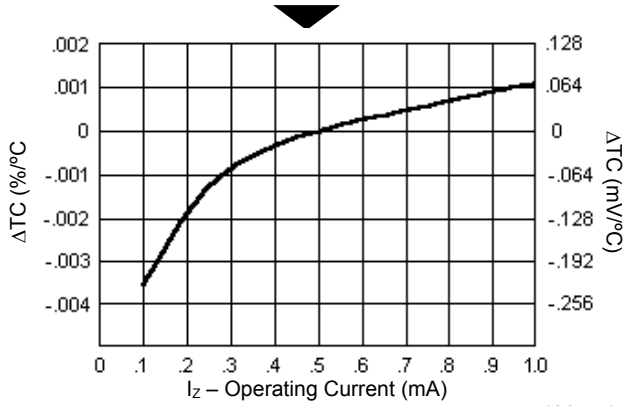

1N4565 – 1N4569A

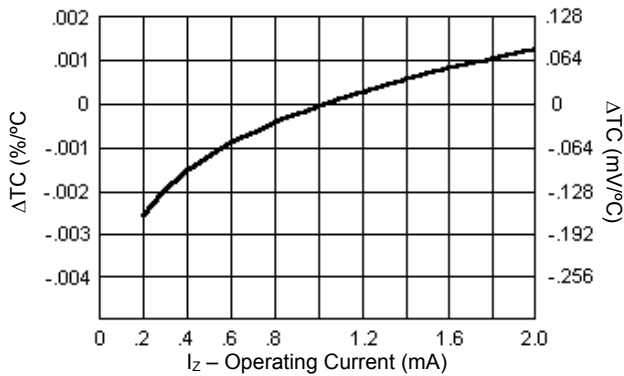
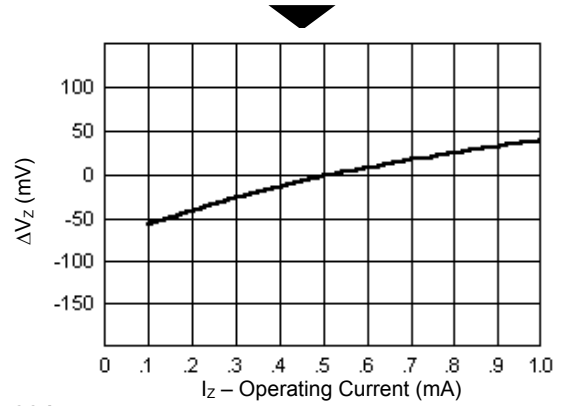

1N4570 – 1N4574A

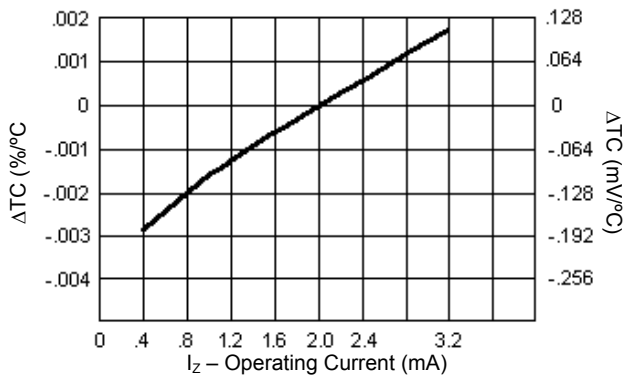
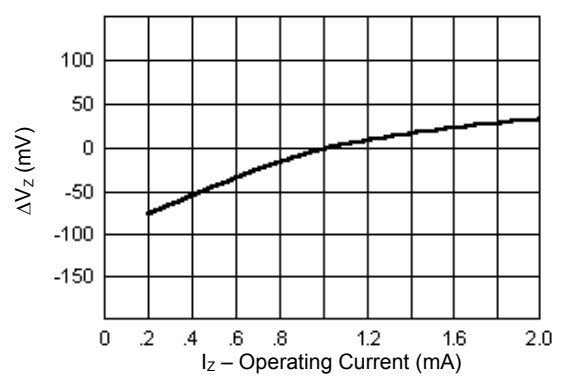

1N4575 – 1N4579A

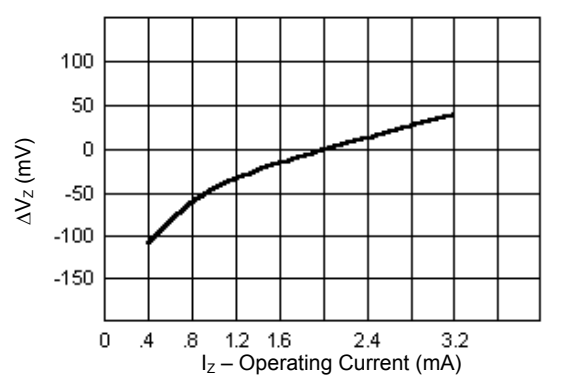

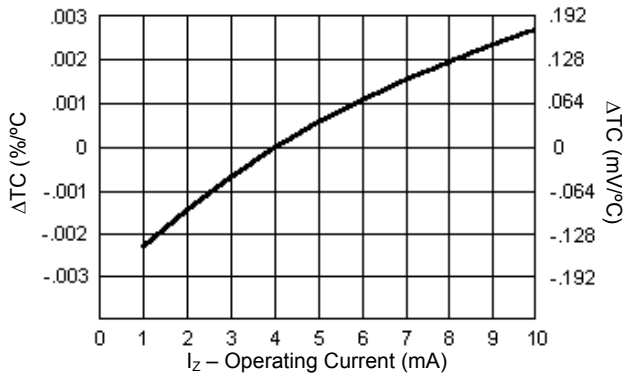

1N4580 - 1N4584A

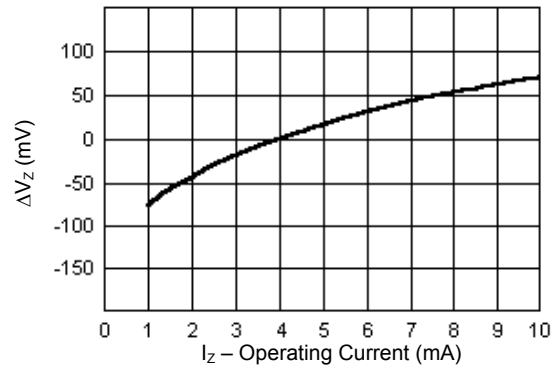

PACKAGE DIMENSIONS

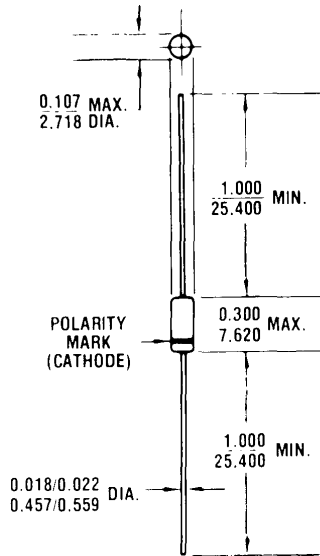

All dimensions in INCH
mm

Mouser Electronics

Authorized Distributor

Click to View Pricing, Inventory, Delivery & Lifecycle Information:

[Microchip:](#)

[1N4565A](#) [1N4565Ae3](#) [1N4570A](#)



Компания «ЭлектроПласт» предлагает заключение долгосрочных отношений при поставках импортных электронных компонентов на взаимовыгодных условиях!

Наши преимущества:

- Оперативные поставки широкого спектра электронных компонентов отечественного и импортного производства напрямую от производителей и с крупнейших мировых складов;
- Поставка более 17-ти миллионов наименований электронных компонентов;
- Поставка сложных, дефицитных, либо снятых с производства позиций;
- Оперативные сроки поставки под заказ (от 5 рабочих дней);
- Экспресс доставка в любую точку России;
- Техническая поддержка проекта, помощь в подборе аналогов, поставка прототипов;
- Система менеджмента качества сертифицирована по Международному стандарту ISO 9001;
- Лицензия ФСБ на осуществление работ с использованием сведений, составляющих государственную тайну;
- Поставка специализированных компонентов (Xilinx, Altera, Analog Devices, Intersil, Interpoint, Microsemi, Aeroflex, Peregrine, Syfer, Eurofarad, Texas Instrument, Miteq, Cobham, E2V, MA-COM, Hittite, Mini-Circuits, General Dynamics и др.);

Помимо этого, одним из направлений компании «ЭлектроПласт» является направление «Источники питания». Мы предлагаем Вам помощь Конструкторского отдела:

- Подбор оптимального решения, техническое обоснование при выборе компонента;
- Подбор аналогов;
- Консультации по применению компонента;
- Поставка образцов и прототипов;
- Техническая поддержка проекта;
- Защита от снятия компонента с производства.



Как с нами связаться

Телефон: 8 (812) 309 58 32 (многоканальный)

Факс: 8 (812) 320-02-42

Электронная почта: org@eplast1.ru

Адрес: 198099, г. Санкт-Петербург, ул. Калинина, дом 2, корпус 4, литера А.