

**SIPMOS® Small-Signal Transistor**

- N channel
- Enhancement mode
- Avalanche rated
- $V_{GS(th)} = 2.1 \dots 4.0 \text{ V}$
- Pb-free lead plating; RoHS compliant
- Qualified according to AEC Q101
- Halogen-free according to IEC61249-2-21

drain pins 2, 4

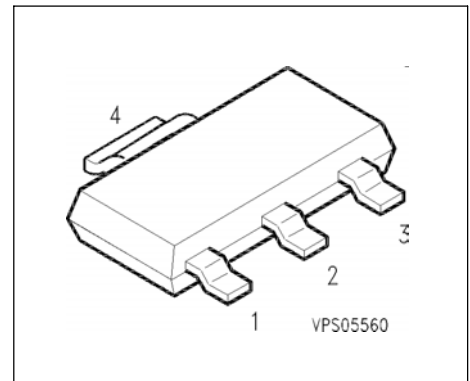

|       |       |       |       |
|-------|-------|-------|-------|
| Pin 1 | Pin 2 | Pin 3 | Pin 4 |
| G     | D     | S     | D     |



| Type   | $V_{DS}$ | $I_D$ | $R_{DS(on)}$ | Package   | Marking |
|--------|----------|-------|--------------|-----------|---------|
| BSP298 | 400 V    | 0.5 A | 3 $\Omega$   | PG-SOT223 | BSP298  |

| Type   | Pb-free | Tape and Reel Information | Packaging |
|--------|---------|---------------------------|-----------|
| BSP298 | Yes     | H6327                     | Dry       |

**Maximum Ratings**

| Parameter  | Symbol      | Values   | Unit |
|--|-------------|----------|------|
| Continuous drain current<br>$T_A = 26 \text{ }^\circ\text{C}$  | $I_D$       | 0.5      | A    |
| DC drain current, pulsed<br>$T_A = 25 \text{ }^\circ\text{C}$  | $I_{Dpuls}$ | 2        | A    |
| Avalanche energy, single pulse<br>$I_D = 1.35 \text{ A}$ , $V_{DD} = 50 \text{ V}$ , $R_{GS} = 25 \text{ } \Omega$<br>$L = 125 \text{ mH}$ , $T_j = 25 \text{ }^\circ\text{C}$ | $E_{AS}$    | 130      | mJ   |
| Gate source voltage  | $V_{GS}$    | $\pm 20$ | V    |
| Power dissipation<br>$T_A = 25 \text{ }^\circ\text{C}$   | $P_{tot}$   | 1.8      | W    |
| ESD Class<br>JESD22-A114-HBM   |             | Class 1b |      |

**Maximum Ratings**

| Parameter  | Symbol     | Values        | Unit |
|--|------------|---------------|------|
| Chip or operating temperature                              | $T_j$      | -55 ... + 150 | °C   |
| Storage temperature  | $T_{stg}$  | -55 ... + 150 |      |
| Thermal resistance, chip to ambient air                    | $R_{thJA}$ | ≤ 70          | K/W  |
| Thermal resistance, junction-soldering point <sup>1)</sup> | $R_{thJS}$ | ≤ 10          |      |
| DIN humidity category, DIN 40 040                          |            | E             |      |
| IEC climatic category, DIN IEC 68-1                        |            | 55 / 150 / 56 |      |

1) Transistor on epoxy pcb 40 mm x 40 mm x 1,5 mm with 6 cm<sup>2</sup> copper area for drain connection

**Electrical Characteristics, at  $T_j = 25^\circ\text{C}$ , unless otherwise specified**

| Parameter | Symbol | Values |      |      | Unit |
|-----------|--------|--------|------|------|------|
|           |        | min.   | typ. | max. |      |

**Static Characteristics**

|  |               |     |           |          |    |
|--|---------------|-----|-----------|----------|----|
| Drain- source breakdown voltage<br>$V_{GS} = 0 \text{ V}, I_D = 0.25 \text{ mA}, T_j = 0^\circ\text{C}$  | $V_{(BR)DSS}$ | 400 | -         | -        | V  |
| Gate threshold voltage<br>$V_{GS}=V_{DS}, I_D = 1 \text{ mA}$  | $V_{GS(th)}$  | 2.1 | 3         | 4        |    |
| Zero gate voltage drain current<br>$V_{DS} = 400 \text{ V}, V_{GS} = 0 \text{ V}, T_j = 25^\circ\text{C}$<br>$V_{DS} = 400 \text{ V}, V_{GS} = 0 \text{ V}, T_j = 125^\circ\text{C}$ | $I_{DSS}$     | -   | 0.1<br>10 | 1<br>100 | μA |
| Gate-source leakage current<br>$V_{GS} = 20 \text{ V}, V_{DS} = 0 \text{ V}$   | $I_{GSS}$     | -   | 10        | 100      |    |
| Drain-Source on-state resistance<br>$V_{GS} = 10 \text{ V}, I_D = 0.5 \text{ A}$   | $R_{DS(on)}$  | -   | 2.2       | 3        | Ω  |

**Electrical Characteristics, at  $T_j = 25^\circ\text{C}$ , unless otherwise specified**

| Parameter  | Symbol       | Values |      |      | Unit |
|--|--------------|--------|------|------|------|
|  |              | min.   | typ. | max. |      |
| <b>Dynamic Characteristics</b>   |              |        |      |      |      |
| Transconductance<br>$V_{DS} \geq 2 \cdot I_D \cdot R_{DS(on)max}$ , $I_D = 0.5 \text{ A}$                                | $g_{fs}$     | 0.5    | 1.2  | -    | S    |
| Input capacitance<br>$V_{GS} = 0 \text{ V}$ , $V_{DS} = 25 \text{ V}$ , $f = 1 \text{ MHz}$                              | $C_{iss}$    | -      | 300  | 400  | pF   |
| Output capacitance<br>$V_{GS} = 0 \text{ V}$ , $V_{DS} = 25 \text{ V}$ , $f = 1 \text{ MHz}$                             | $C_{oss}$    | -      | 50   | 75   |      |
| Reverse transfer capacitance<br>$V_{GS} = 0 \text{ V}$ , $V_{DS} = 25 \text{ V}$ , $f = 1 \text{ MHz}$                   | $C_{rss}$    | -      | 20   | 30   |      |
| Turn-on delay time<br>$V_{DD} = 30 \text{ V}$ , $V_{GS} = 10 \text{ V}$ , $I_D = 0.3 \text{ A}$<br>$R_{GS} = 50 \Omega$  | $t_{d(on)}$  | -      | 10   | 15   | ns   |
| Rise time<br>$V_{DD} = 30 \text{ V}$ , $V_{GS} = 10 \text{ V}$ , $I_D = 0.3 \text{ A}$<br>$R_{GS} = 50 \Omega$           | $t_r$        | -      | 25   | 40   |      |
| Turn-off delay time<br>$V_{DD} = 30 \text{ V}$ , $V_{GS} = 10 \text{ V}$ , $I_D = 0.3 \text{ A}$<br>$R_{GS} = 50 \Omega$ | $t_{d(off)}$ | -      | 30   | 40   |      |
| Fall time<br>$V_{DD} = 30 \text{ V}$ , $V_{GS} = 10 \text{ V}$ , $I_D = 0.3 \text{ A}$<br>$R_{GS} = 50 \Omega$           | $t_f$        | -      | 20   | 30   |      |

**Electrical Characteristics**, at  $T_j = 25^\circ\text{C}$ , unless otherwise specified

| Parameter | Symbol | Values |      |      | Unit |
|-----------|--------|--------|------|------|------|
|           |        | min.   | typ. | max. |      |

#### Reverse Diode

|  |          |   |      |     |               |
|--|----------|---|------|-----|---------------|
| Inverse diode continuous forward current<br>$T_A = 25^\circ\text{C}$                                   | $I_S$    | - | -    | 0.5 | A             |
| Inverse diode direct current, pulsed<br>$T_A = 25^\circ\text{C}$                                       | $I_{SM}$ | - | -    | 2   |               |
| Inverse diode forward voltage<br>$V_{GS} = 0\text{ V}$ , $I_F = 1\text{ A}$ , $T_j = 25^\circ\text{C}$ | $V_{SD}$ | - | 0.95 | 1.2 | V             |
| Reverse recovery time<br>$V_R = 100\text{ V}$ , $I_F = I_S$ , $di_F/dt = 100\text{ A}/\mu\text{s}$     | $t_{rr}$ | - | 300  | -   | ns            |
| Reverse recovery charge<br>$V_R = 100\text{ V}$ , $I_F = I_S$ , $di_F/dt = 100\text{ A}/\mu\text{s}$   | $Q_{rr}$ | - | 2.5  | -   | $\mu\text{C}$ |

**Power dissipation**

$$P_{tot} = f(T_A)$$

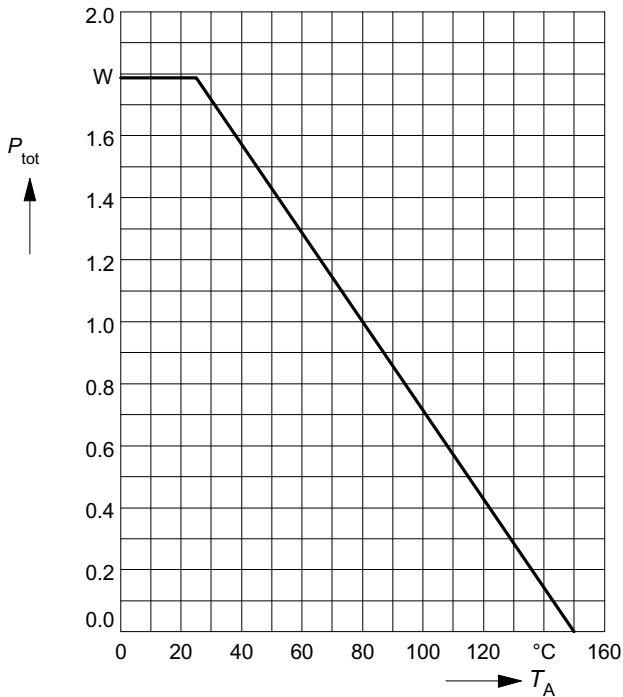

**Drain current**

$$I_D = f(T_A)$$

parameter:  $V_{GS} \geq 10 \text{ V}$

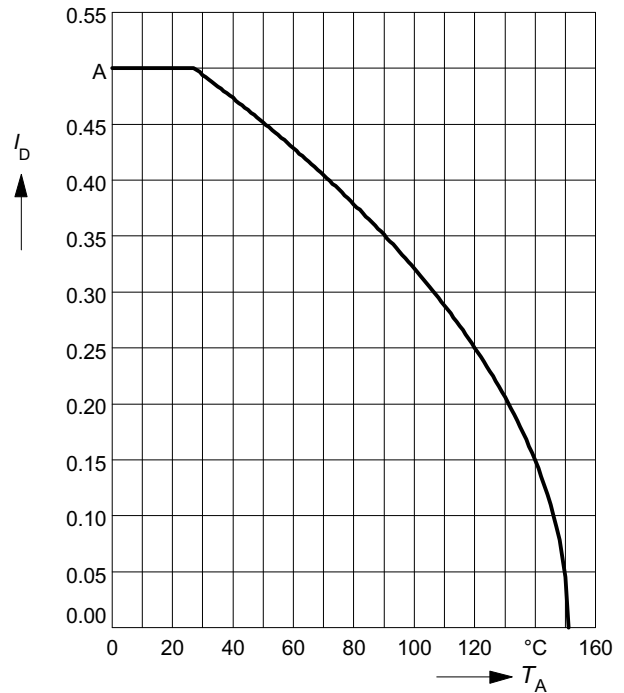

**Safe operating area  $I_D = f(V_{DS})$**

parameter :  $D = 0, T_C = 25^\circ\text{C}$

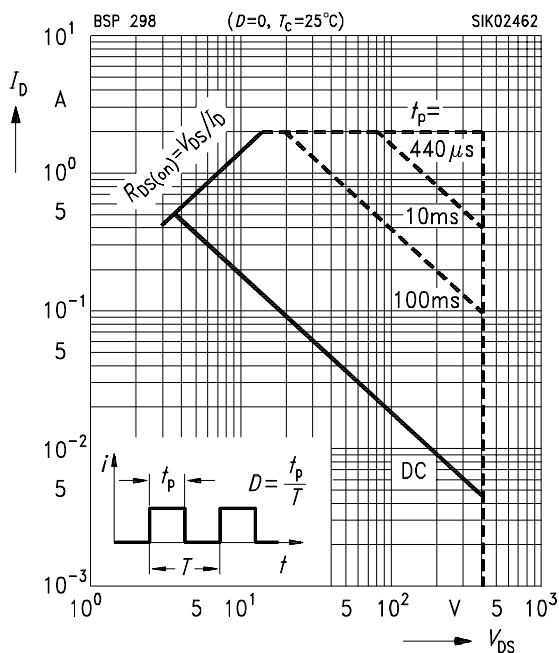

**Transient thermal impedance**

$$Z_{th\text{JA}} = f(t_p)$$

parameter:  $D = t_p / T$

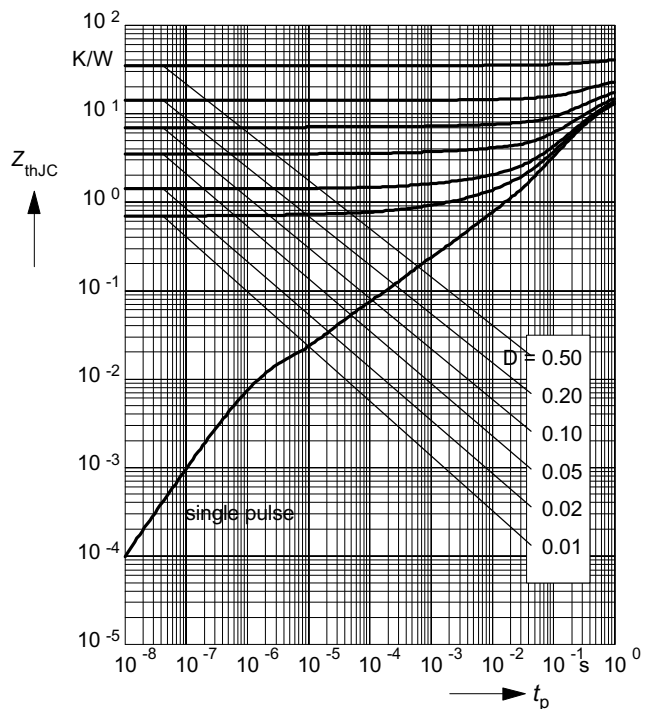

**Typ. output characteristics**

$I_D = f(V_{DS})$

parameter:  $t_p = 80 \mu s$ ,  $T_j = 25 \text{ }^\circ\text{C}$

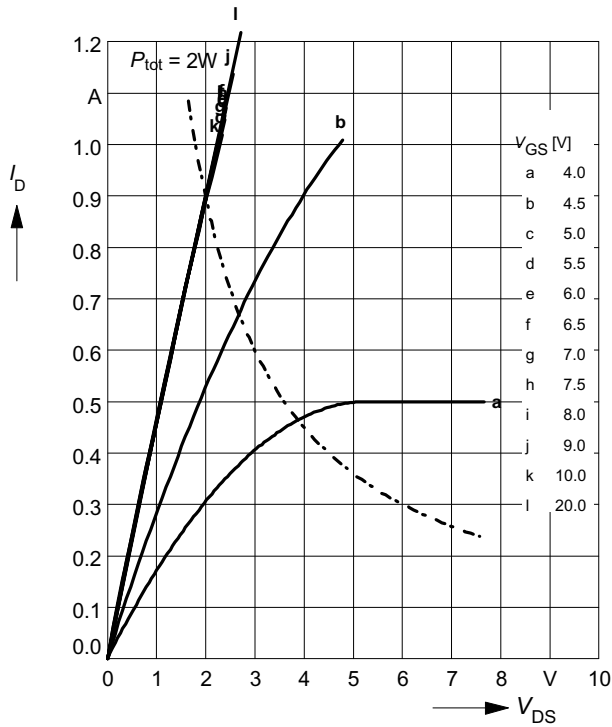

**Typ. drain-source on-resistance**

$R_{DS(on)} = f(I_D)$

parameter:  $t_p = 80 \mu s$ ,  $T_j = 25 \text{ }^\circ\text{C}$

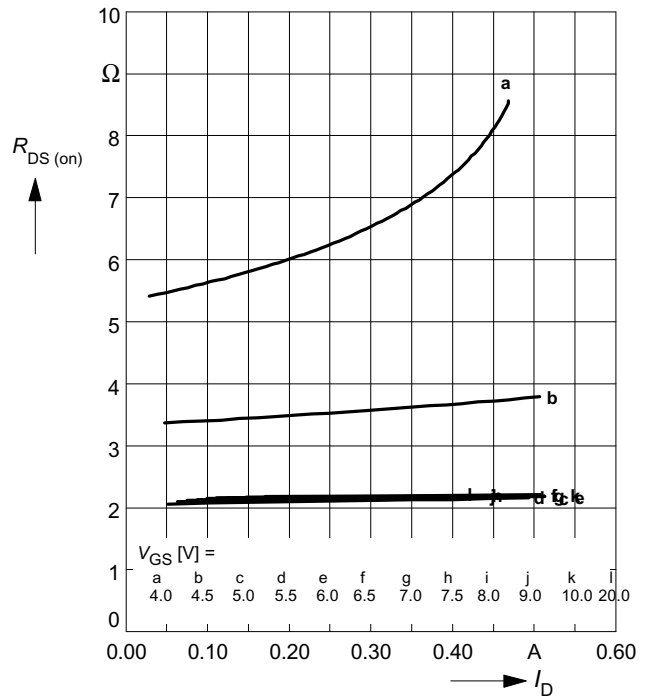

**Typ. transfer characteristics  $I_D = f(V_{GS})$**

parameter:  $t_p = 80 \mu s$

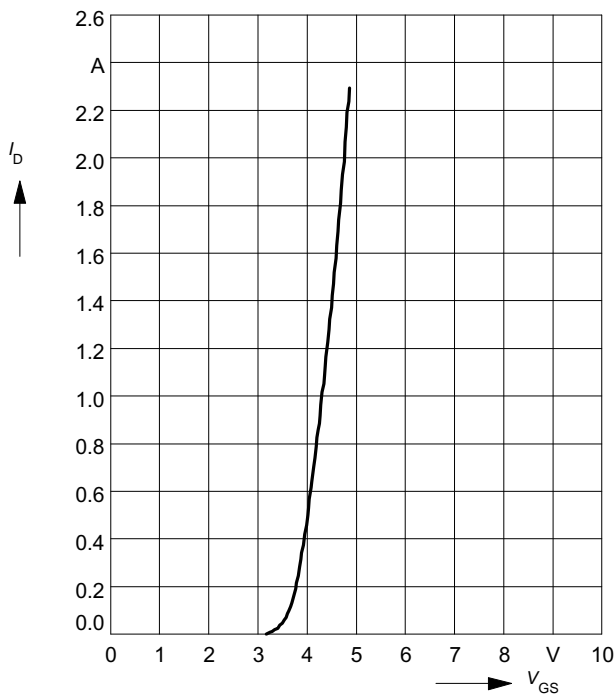

**Typ. forward transconductance  $g_{fs} = f(I_D)$**

parameter:  $t_p = 80 \mu s$ ,

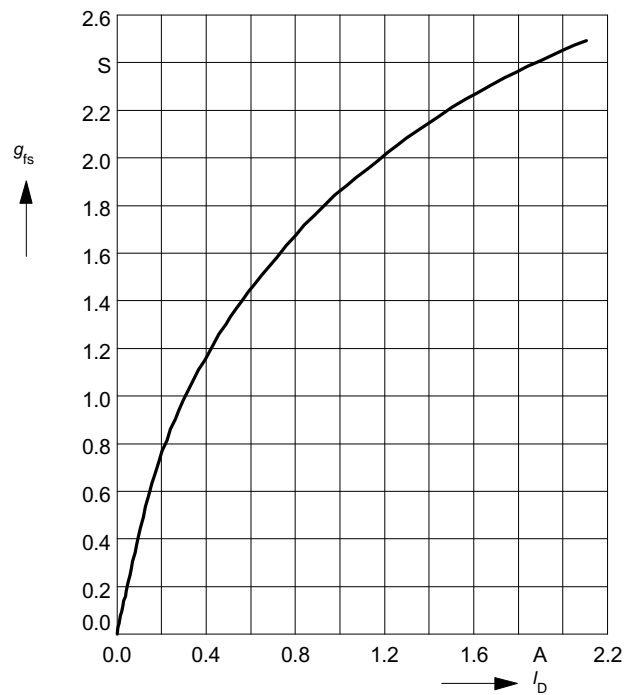

**Drain-source on-resistance**

$$R_{DS(on)} = f(T_j)$$

parameter:  $I_D = 0.5 \text{ A}$ ,  $V_{GS} = 10 \text{ V}$

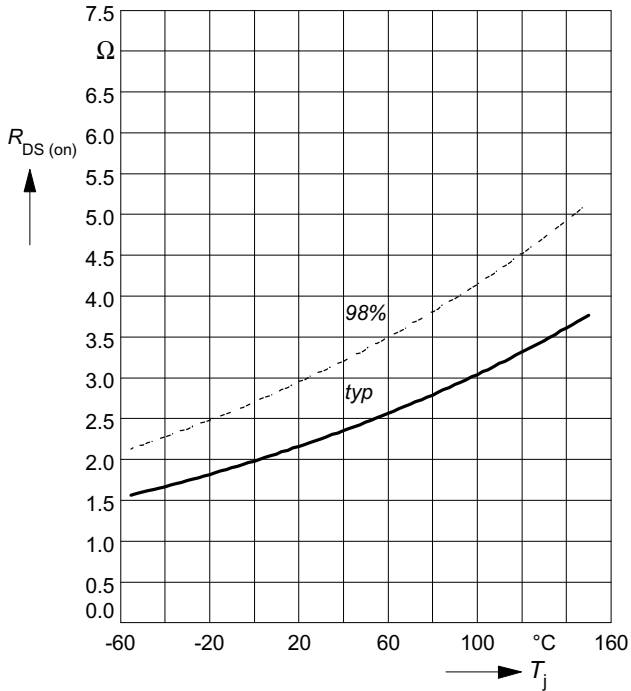

**Gate threshold voltage**

$$V_{GS(th)} = f(T_j)$$

parameter:  $V_{GS} = V_{DS}$ ,  $I_D = 1 \text{ mA}$

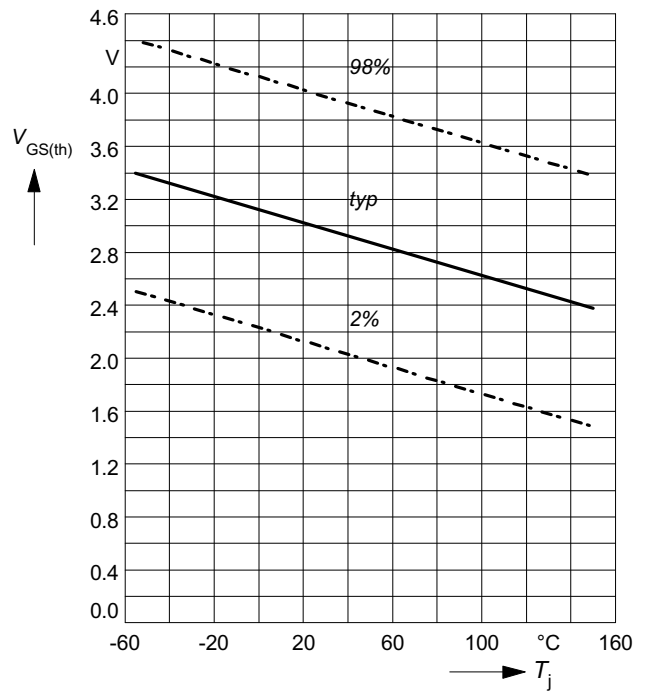

**Typ. capacitances**

$$C = f(V_{DS})$$

parameter:  $V_{GS}=0\text{V}$ ,  $f = 1 \text{ MHz}$

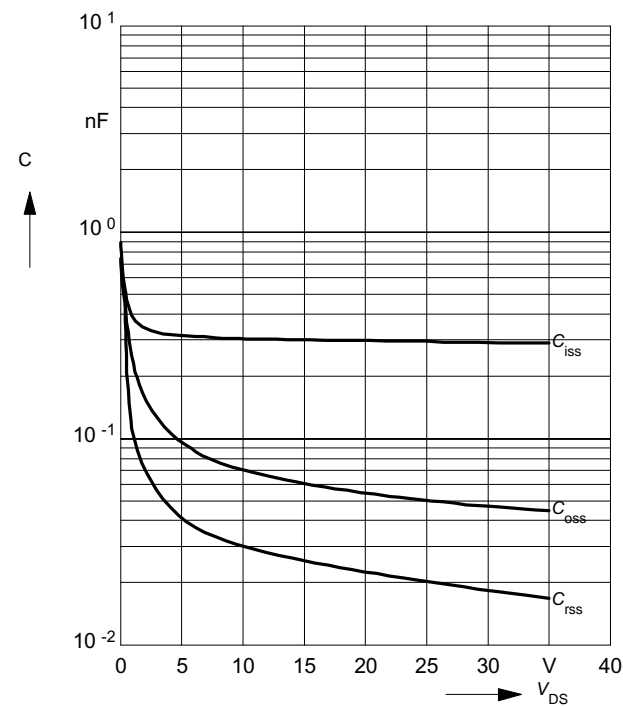

**Forward characteristics of reverse diode**

$$I_F = f(V_{SD})$$

parameter:  $T_j, t_p = 80 \mu\text{s}$

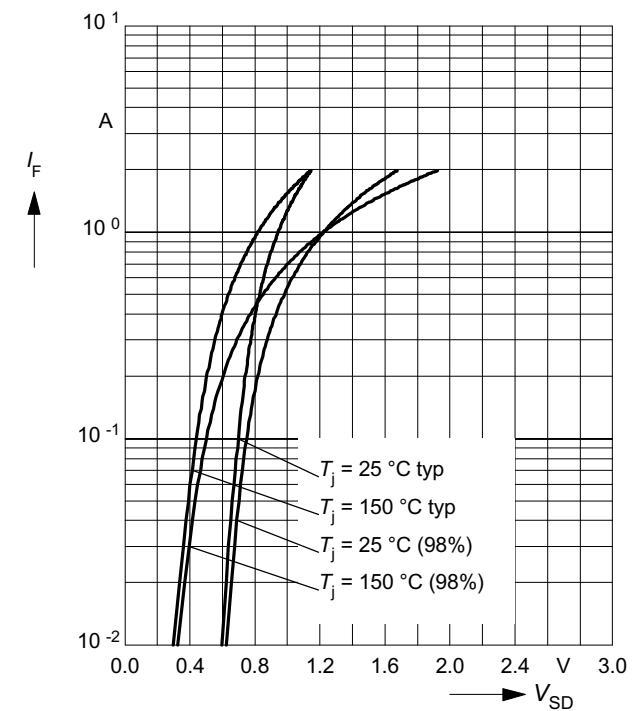

**Avalanche energy**  $E_{AS} = f(T_j)$   
 parameter:  $I_D = 1.35\text{ A}$ ,  $V_{DD} = 50\text{ V}$   
 $R_{GS} = 25\ \Omega$ ,  $L = 125\text{ mH}$

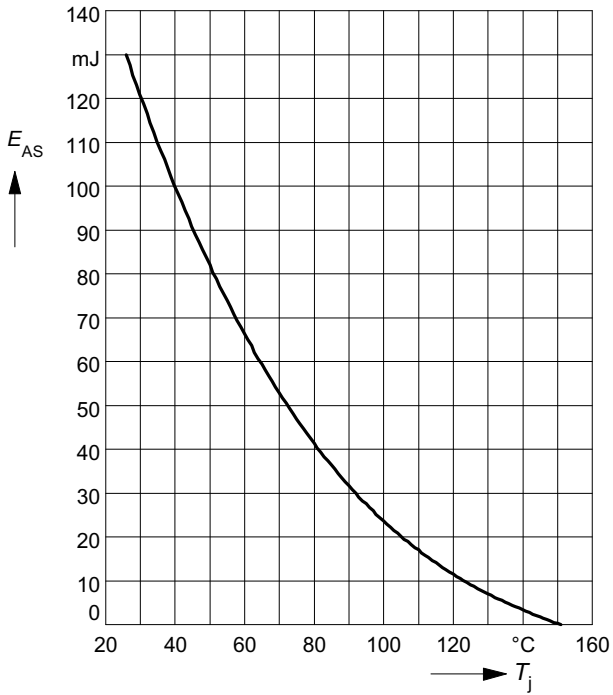

**Drain-source breakdown voltage**  
 $V_{(BR)DSS} = f(T_j)$

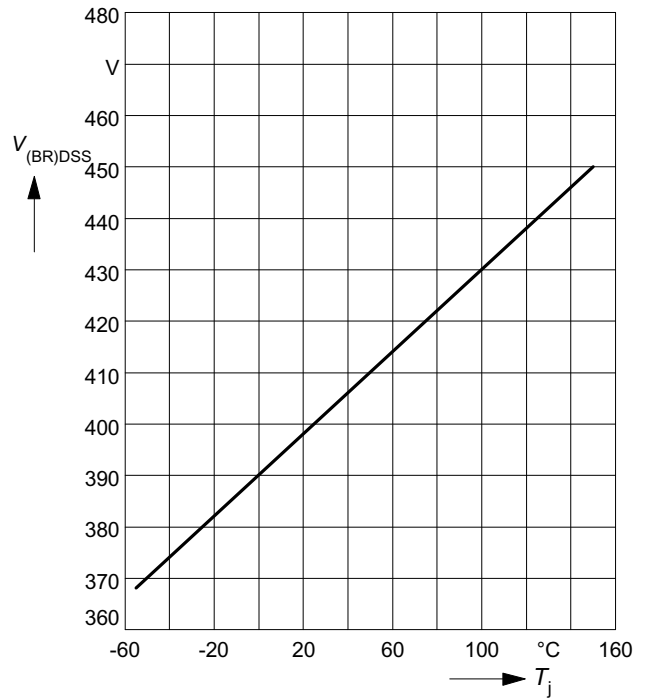

**Safe operating area**  $I_D = f(V_{DS})$   
 parameter :  $D = 0.01$ ,  $T_C = 25^\circ\text{C}$

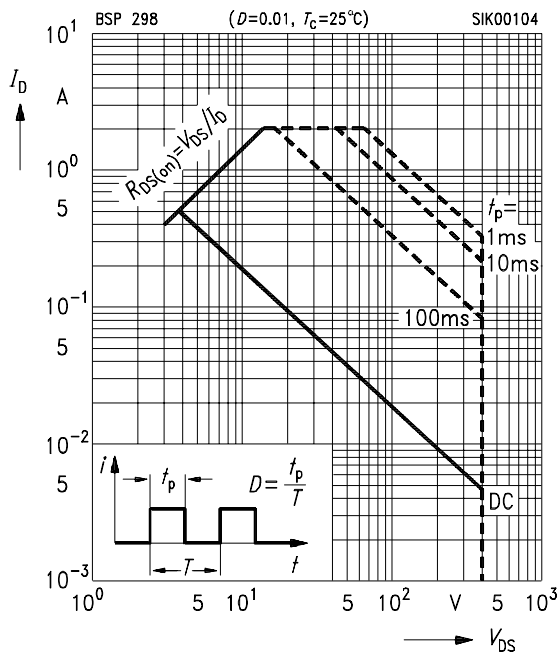



**Package outlines**

SOT-223

Dimensions in mm

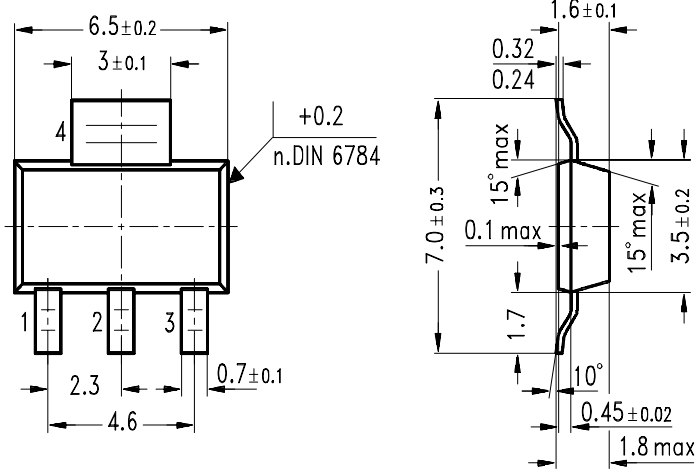

GPS05560

**Published by**  
**Infineon Technologies AG**  
**81726 Munich, Germany**  
**© 2008 Infineon Technologies AG**  
**All Rights Reserved.**

#### **Legal Disclaimer**

The information given in this document shall in no event be regarded as a guarantee of conditions or characteristics. With respect to any examples or hints given herein, any typical values stated herein and/or any information regarding the application of the device, Infineon Technologies hereby disclaims any and all warranties and liabilities of any kind, including without limitation, warranties of non-infringement of intellectual property rights of any third party.

#### **Information**

For further information on technology, delivery terms and conditions and prices, please contact the nearest Infineon Technologies Office ([www.infineon.com](http://www.infineon.com)).

#### **Warnings**

Due to technical requirements, components may contain dangerous substances. For information on the types in question, please contact the nearest Infineon Technologies Office. Infineon Technologies components may be used in life-support devices or systems only with the express written approval of Infineon Technologies, if a failure of such components can reasonably be expected to cause the failure of that life-support device or system or to affect the safety or effectiveness of that device or system. Life support devices or systems are intended to be implanted in the human body or to support and/or maintain and sustain and/or protect human life. If they fail, it is reasonable to assume that the health of the user or other persons may be endangered.



Компания «ЭлектроПласт» предлагает заключение долгосрочных отношений при поставках импортных электронных компонентов на взаимовыгодных условиях!

Наши преимущества:

- Оперативные поставки широкого спектра электронных компонентов отечественного и импортного производства напрямую от производителей и с крупнейших мировых складов;
- Поставка более 17-ти миллионов наименований электронных компонентов;
- Поставка сложных, дефицитных, либо снятых с производства позиций;
- Оперативные сроки поставки под заказ (от 5 рабочих дней);
- Экспресс доставка в любую точку России;
- Техническая поддержка проекта, помощь в подборе аналогов, поставка прототипов;
- Система менеджмента качества сертифицирована по Международному стандарту ISO 9001;
- Лицензия ФСБ на осуществление работ с использованием сведений, составляющих государственную тайну;
- Поставка специализированных компонентов (Xilinx, Altera, Analog Devices, Intersil, Interpoint, Microsemi, Aeroflex, Peregrine, Syfer, Eurofarad, Texas Instrument, Miteq, Cobham, E2V, MA-COM, Hittite, Mini-Circuits, General Dynamics и др.);

Помимо этого, одним из направлений компании «ЭлектроПласт» является направление «Источники питания». Мы предлагаем Вам помощь Конструкторского отдела:

- Подбор оптимального решения, техническое обоснование при выборе компонента;
- Подбор аналогов;
- Консультации по применению компонента;
- Поставка образцов и прототипов;
- Техническая поддержка проекта;
- Защита от снятия компонента с производства.



#### Как с нами связаться

**Телефон:** 8 (812) 309 58 32 (многоканальный)

**Факс:** 8 (812) 320-02-42

**Электронная почта:** [org@eplast1.ru](mailto:org@eplast1.ru)

**Адрес:** 198099, г. Санкт-Петербург, ул. Калинина, дом 2, корпус 4, литера А.