

LCA Series Subminiature Snap-acting Switches



Features/Benefits

- Compact design
- Long life and high electrical capacity
- Quick connect, solder terminals, PC terminals
- Wide variety of actuator styles
- RoHS compatible

Typical Applications

- Motorized equipment
- Sump pump
- Thermostatic controls

UL61058-1



Specifications

CONTACT RATING: From low level to 10.1 AMPS @ 125/250 V AC
 ELECTRICAL LIFE: see chart below
 MECHANICAL LIFE: 300,000 cycles.
 INSULATION RESISTANCE: 100 M ohm min.
 DIELECTRIC STRENGTH: 1,500 Vrms min. @ sea level.
 OPERATING TEMPERATURE: -40°C to +125°C
 OPERATING FORCE: 150 grams at actuator button MAX.
 Forces are less at free end of lever actuators; (see ACTUATOR'S option sections).
 MOUNTING: 2-56 screws, torque 2.3 in/lbs max.

Materials

SWITCH HOUSING: Thermoplastic polyester
 ACTUATOR BUTTON: Thermoplastic polyester.
 SPRING: Copper alloy.
 PIVOT: Copper alloy.
 MOVABLE CONTACTS: Silver alloy
 STATIONARY CONTACTS: Silver alloy
 TERMINALS: Copper alloy.
 ACTUATOR LEVER: Stainless steel.

NOTE: Specifications and materials listed above are for switches with standard options. For information on specific and custom switches, consult Customer Service center.

Build-A-Switch

To order, simply select desired option from each category and place in the appropriate box. Available options are shown and described on pages J-36 thru J-39. For additional options not shown in catalog, consult Customer Service Center.

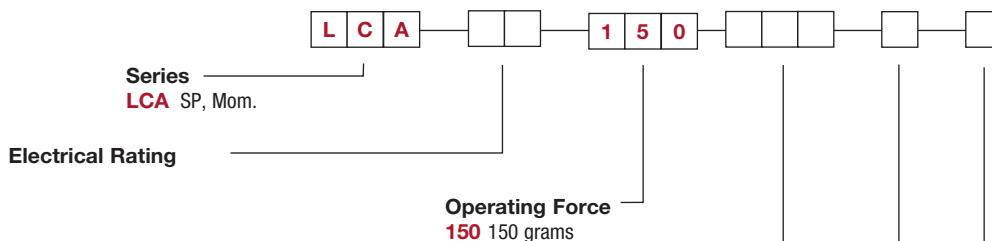

Option Code	UL cUL _{US} 1054	UL cUL _{US} 61058-1	
01	0.1 A 125/250 V AC 1E6	0.1 A 125/250 V AC 1E6	0.1 A 125/250 V AC 1E6
06	6 A 125/250 V AC 1E4	6 A 125/250 V AC 1E4	6 (2)A 125/250 V AC 1E4
10	10.1 A 125/250 V AC 1E4	10.1 A 125/250 V AC 1E4	10.1 A 125/250 V AC 1E4
S5	NA	5 A 125/250 V AC 1E5	NA

Actuator

- P00** Pin plunger
- T05** 4.8 mm short lever
- T06** 6.8 mm lever
- T09** 8.8 mm lever
- T12** 12.9 mm lever
- T16** 15.2 mm lever
- T18** 18.1 mm lever
- T21** 20.1 mm lever
- T23** 23.4 mm lever
- T43** 43.5 mm lever
- S06** 6.0 mm simulated lever
- S09** 9.2 mm simulated lever
- A05** 5.0 mm lever roller

Terminations

- S** Solder
- Q** .110 Quick Connect
- P** PC Thru Hole
- L** Left Form PC
- R** Right Form PC

Circuitry

- C** SPDT
- W** SPST N.C.
- Y** SPST N.O.



Dimensions are shown: mm

Specifications and dimensions subject to change



LCA Series Subminiature Snap-acting Switches

ACTUATOR

A05 LEVER ROLLER

SXX SIMULATED ROLLER

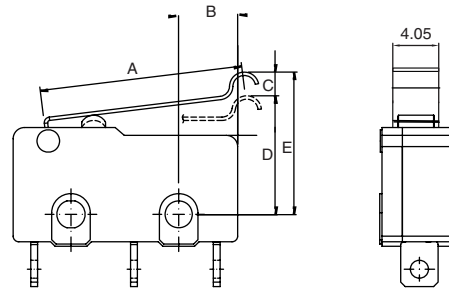
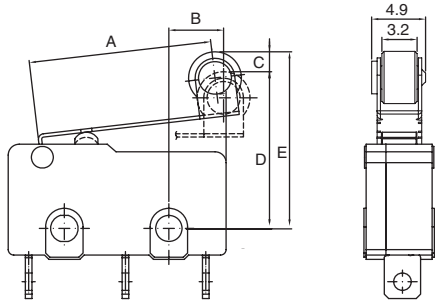

TXX LEVER

P00

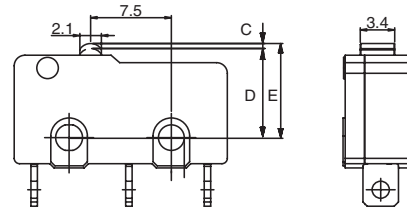
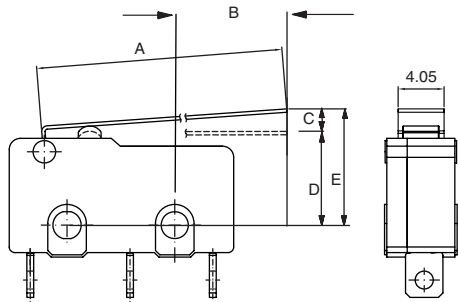

Snap-acting

ACTUATOR OPTION CODE	A mm	B ref. mm	C mm	D mm	E mm	Diff. Motion mm	Oper. Force max. grams	Release Force min. grams	Over Travel min.
	LENGTH OF LEVER	Lever length for front mtg. hole to OP	PRE TRAVEL (MAX)	OPERATING POSITION	FREE POSITION (MAX)	max			
P00	NA	NA	1.10	8.55 ± 0.3	9.35	0.20	150	25	0.4
T05	16.70	4.80	3.60	8.95 ± 0.8	11.75	0.80	50	6	0.6
T06	18.70	6.80	4.03	8.9 ± 0.9	12.09	0.90	45	5	0.67
T09	20.60	9.10	5.64	9.15 ± 1.35	13.45	1.83	33	2	0.75
T12	24.80	12.90	3.35	8.95 ± 1.5	13.10	1.19	34	2	0.89
T16	27.10	15.20	7.20	9.15 ± 1.7	15.15	1.30	40	1	0.70
T18	30.00	18.10	7.70	8.95 ± 1.9	14.65	1.50	32	1	1.2
T21	32.00	20.10	8.00	8.15 ± 1.85	15.55	1.60	35	1	1.0
T23	35.20	23.40	8.60	8.95 ± 2.0	15.55	1.80	25	1	1.5
T43	55.20	43.50	10.45	8.95 ± 3.0	19.25	2.90	15	1	1.0
S06	17.90	6.00	3.86	10.85 ± 0.9	17.81	0.86	47	5	0.64
S09	21.10	9.20	5.7	16.15 ± 1.5	20.35	1.00	42	2	1.0
A05	16.60	5.00	3.8	14.65 ± 0.8	17.65	0.80	50	6	0.6

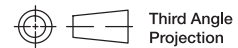

Third Angle
Projection

Dimensions are shown: mm
Specifications and dimensions subject to change

LCA Series Subminiature Snap-acting Switches

TERMINATIONS

S SOLDER

Q QUICK CONNECT

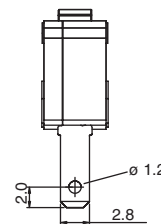
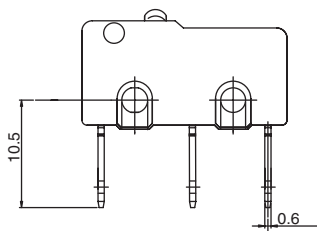
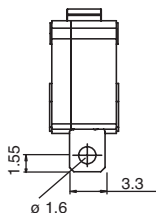
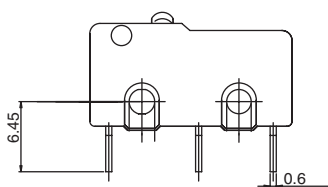

P PC THRU HOLE

L LEFT FORM PC

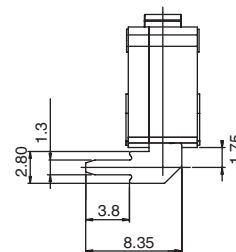
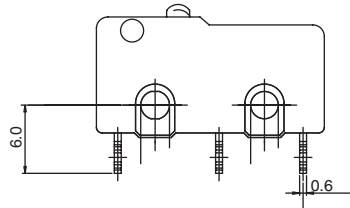
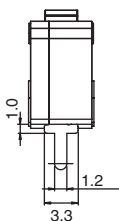
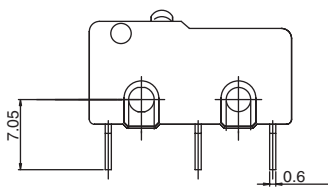

R RIGHT FORM PC

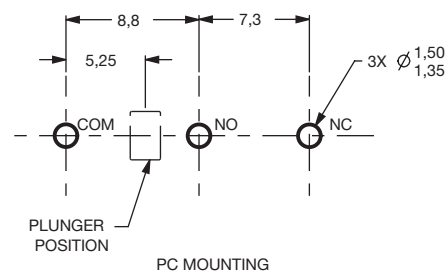
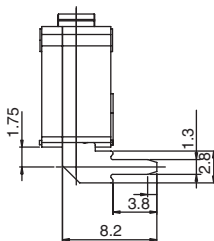
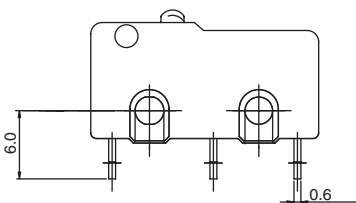

Snap-acting

CIRCUITRY

C SPDT (Single Pole, Double Throw)

W SPST N.C. (Single Pole, Single Throw, Normally Closed)

Y SPST N.O. (Single Pole, Single Throw, Normally Open)

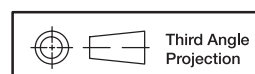

Dimensions are shown: mm
Specifications and dimensions subject to change





Компания «ЭлектроПласт» предлагает заключение долгосрочных отношений при поставках импортных электронных компонентов на взаимовыгодных условиях!

Наши преимущества:

- Оперативные поставки широкого спектра электронных компонентов отечественного и импортного производства напрямую от производителей и с крупнейших мировых складов;
- Поставка более 17-ти миллионов наименований электронных компонентов;
- Поставка сложных, дефицитных, либо снятых с производства позиций;
- Оперативные сроки поставки под заказ (от 5 рабочих дней);
- Экспресс доставка в любую точку России;
- Техническая поддержка проекта, помощь в подборе аналогов, поставка прототипов;
- Система менеджмента качества сертифицирована по Международному стандарту ISO 9001;
- Лицензия ФСБ на осуществление работ с использованием сведений, составляющих государственную тайну;
- Поставка специализированных компонентов (Xilinx, Altera, Analog Devices, Intersil, Interpoint, Microsemi, Aeroflex, Peregrine, Syfer, Eurofarad, Texas Instrument, Miteq, Cobham, E2V, MA-COM, Hittite, Mini-Circuits, General Dynamics и др.);

Помимо этого, одним из направлений компании «ЭлектроПласт» является направление «Источники питания». Мы предлагаем Вам помощь Конструкторского отдела:

- Подбор оптимального решения, техническое обоснование при выборе компонента;
- Подбор аналогов;
- Консультации по применению компонента;
- Поставка образцов и прототипов;
- Техническая поддержка проекта;
- Защита от снятия компонента с производства.



Как с нами связаться

Телефон: 8 (812) 309 58 32 (многоканальный)

Факс: 8 (812) 320-02-42

Электронная почта: org@eplast1.ru

Адрес: 198099, г. Санкт-Петербург, ул. Калинина, дом 2, корпус 4, литера А.