

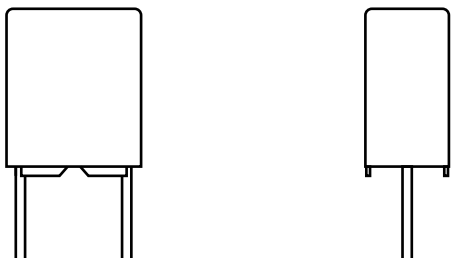

Interference Suppression Film Capacitors MKT Radial Potted Type



FEATURES

- 15 mm to 37.5 mm lead pitch
- Supplied loose in box, taped on reel
- Material categorization:
for definitions of compliance please see
www.vishay.com/doc?99912



RoHS
COMPLIANT
HALOGEN
FREE

APPLICATIONS

High stability grade for continuous across the line X2 applications.

See also application note: www.vishay.com/doc?28153

QUICK REFERENCE DATA	
Capacitance range (E12 series)	E12 series 0.01 μ F to 2.2 μ F preferred values acc. to E6
Capacitance tolerance	$\pm 10\%$, $\pm 20\%$
Rated AC voltage	300 V _{AC} ; 50 Hz to 60 Hz
Permissible DC voltage	800 V _{DC} at 85 °C 630 V _{DC} at 110 °C
Climatic testing class acc. to IEC 60068-1	40/100/56/C
Maximum application temperature	100 °C
Reference standards	IEC 60384-14 ed-3 and EN 60384-14 IEC 60065 pass. flamm. class C CSA-E384-14 UL 60384-14
Dielectric	Polyester film
Electrodes	Metallized
Construction	Series construction 
Encapsulation	Plastic case, epoxy resin sealed, flame retardant UL-class 94 V-0
Leads	Tinned wire
Marking	C-value; tolerance; rated voltage; sub-class; manufacturer's type; code for dielectric material; manufacturer location; manufacturer's logo; year and week; safety approvals

Note

- For more detailed data and test requirements, contact rfi@vishay.com

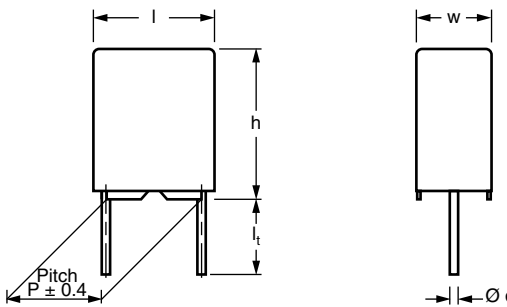
DIMENSIONS in millimeters

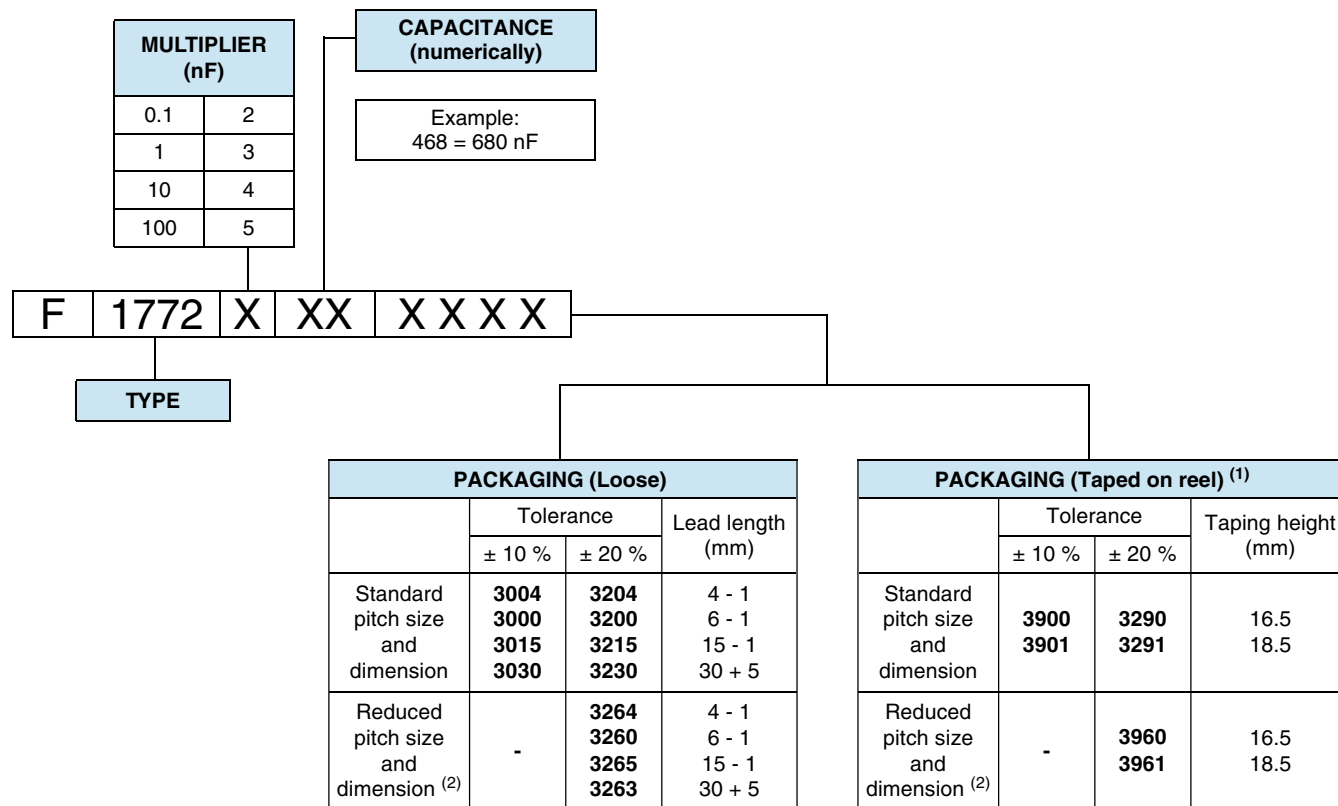
**COMPOSITION OF CATALOG NUMBER**

Example: F17724153215 means 0.15 μ F, \pm 20 %; standard pitch 22.5 mm; lead length 15 mm - 1 mm;
 F17724153265 means 0.15 μ F, \pm 20 %; reduced pitch 15.0 mm; lead length 15 mm - 1 mm

Notes

- For detailed tape specifications refer to packaging information www.vishay.com/doc?28139
- ⁽¹⁾ Taped on reel pitch \geq 27.5 mm is not available
- ⁽²⁾ Same capacitance values \geq 0.15 μ F at 20 % are available in two different pitch sizes and dimensions

SPECIFIC REFERENCE DATA	
DESCRIPTION	VALUE
Rated AC voltage (U_{RAC})	300 V
Permissible DC voltage (U_{RDC})	630 V
Tangent of loss angle	$\leq 100 \times 10^{-4}$ at 1 kHz
Rated voltage pulse slope at $(dU/dt)_R$ 435 V _{DC}	100 V/ μ s
R between leads, for $C \leq 0.33 \mu$ F at 100 V; 1 min	$> 15\,000 \text{ M}\Omega$
RC between leads, $C > 0.33 \mu$ F at 100 V; 1 min	$> 5000 \text{ s}$
R between leads and case; 100 V; 1 min	$> 30\,000 \text{ M}\Omega$
Withstanding (DC) voltage (cut off current 10 mA) ⁽¹⁾ ; rise time $\leq 1000 \text{ V/s}$	2150 V; for 1 min
Withstanding (AC) voltage between leads and case	2500 V; for 2 s at 25 °C
Maximum application temperature	100 °C

Note

- See "Voltage Proof Test for Metalized Film Capacitors": www.vishay.com/doc?28169



ELECTRICAL DATA AND ORDERING INFORMATION						
U_{RAC} (V)	CAP. (μ F)	PITCH (mm)	DIMENSIONS w x h x l MAX. (mm)	MASS ⁽³⁾ (g)	SPQ (pieces) SHORT LEAD	ORDERING CODE BULK LEAD LENGTH 6 mm - 1 mm ⁽¹⁾⁽²⁾
300	$d_t = 0.60 \text{ mm} \pm 0.06 \text{ mm}$; C-TOL. = $\pm 10 \%$					
	0.010	15	5.0 x 11.0 x 17.5	1.4	750	F17723103000
	0.012	15	5.0 x 11.0 x 17.5	1.4	750	F17723123000
	0.015	15	5.0 x 11.0 x 17.5	1.4	750	F17723153000
	0.018	15	5.0 x 11.0 x 17.5	1.4	750	F17723183000
	0.022	15	5.0 x 11.0 x 17.5	1.4	750	F17723223000
	0.027	15	5.0 x 11.0 x 17.5	1.4	750	F17723273000
	0.033	15	5.0 x 11.0 x 17.5	1.4	750	F17723333000
	0.039	15	6.0 x 12.0 x 17.5	2.0	500	F17723393000
	0.047	15	6.0 x 12.0 x 17.5	2.0	500	F17723473000
	0.056	15	6.0 x 12.0 x 17.5	2.0	500	F17723563000
	$d_t = 0.80 \text{ mm} \pm 0.08 \text{ mm}$; C-TOL. = $\pm 10 \%$					
	0.068	15	7.0 x 13.5 x 17.5	2.4	450	F17723683000
	0.082	15	8.5 x 15.0 x 17.5	2.7	300	F17723823000
	0.10	15	8.5 x 15.0 x 17.5	2.7	325	F17724103000
	0.12	15	8.5 x 15.0 x 17.5	2.7	300	F17724123000
	0.15	22.5	7.0 x 16.5 x 26.0	4.1	235	F17724153000
	0.18	22.5	7.0 x 16.5 x 26.0	4.1	235	F17724183000
	0.22	22.5	8.5 x 18.0 x 26.0	4.6	200	F17724223000
	0.33	27.5	11.0 x 20.3 x 31.3	6.7	170	F17724333000
	0.39	27.5	11.0 x 21.0 x 31.0	9.1	125	F17724393000
	0.47	27.5	11.0 x 21.0 x 31.0	9.1	125	F17724473000
	0.56	27.5	11.0 x 21.0 x 31.0	9.1	125	F17724563000
	0.68	27.5	13.0 x 23.0 x 31.0	12.9	110	F17724683000
	0.82	27.5	13.0 x 23.0 x 31.0	12.9	110	F17724823000
	1.0	27.5	15.0 x 25.0 x 31.5	15.0	100	F17725103000
	1.5	37.5	15.5 x 28.5 x 41.5	24.0	70	F17725153000
	1.8	37.5	15.5 x 28.5 x 41.5	24.0	70	F17725183000
	2.2	37.5	18.0 x 32.5 x 41.5	31.6	60	F17725223000
	$d_t = 0.60 \text{ mm} \pm 0.06 \text{ mm}$; C-TOL. = $\pm 20 \%$					
	0.010	15	5.0 x 11.0 x 17.5	1.4	750	F17723103200
	0.015	15	5.0 x 11.0 x 17.5	1.4	750	F17723153200
	0.022	15	5.0 x 11.0 x 17.5	1.4	750	F17723223200
0.033	15	5.0 x 11.0 x 17.5	1.4	750	F17723333200	
0.047	15	5.0 x 11.0 x 17.5	1.4	750	F17723473200	
0.068	15	6.0 x 12.0 x 17.5	2.0	600	F17723683200	
0.10	15	6.0 x 12.0 x 17.5	2.0	600	F17724103200	



ELECTRICAL DATA AND ORDERING INFORMATION						
U_{RAC} (V)	CAP. (μF)	PITCH (mm)	DIMENSIONS w x h x l MAX. (mm)	MASS ⁽³⁾ (g)	SPQ (pieces) SHORT LEAD	ORDERING CODE BULK LEAD LENGTH 6 mm - 1 mm ⁽¹⁾⁽²⁾
d_t = 0.80 mm ± 0.08 mm; C-TOL. = ± 20 %						
300	0.15	15	8.5 x 15.0 x 17.5	2.7	325	F17724153260
	0.15	22.5	6.0 x 15.5 x 26.0	3.3	260	F17724153200
	0.22	15	10.0 x 16.5 x 17.5	4.5	300	F17724223260
	0.22	22.5	7.0 x 16.5 x 26.0	4.1	235	F17724223200
	0.33	22.5	8.5 x 18.0 x 26.0	5.3	190	F1772433200
	0.47	22.5	10.0 x 19.5 x 26.0	6.7	170	F17724473260
	0.47	27.5	9.0 x 19.0 x 31.5	6.8	160	F17724473200
	0.68	22.5	12.0 x 22.0 x 26.0	13.4	110	F17724683260
	0.68	27.5	11.0 x 21.0 x 31.0	12.9	125	F17724683200
	1.0	22.5	15.5 x 26.5 x 26.5	13.5	110	F17725103260
	1.0	27.5	15.0 x 25.0 x 31.5	15.0	100	F17725103200
	1.5	27.5	18.0 x 28.0 x 31.5	19.0	85	F17725153260
	1.5	37.5	14.5 x 24.5 x 41.5	18.9	80	F17725153200
2.2	37.5	15.5 x 28.5 x 41.5	24.0	70	F17725223200	

Notes

- SPQ = Standard Packing Quantity
- For detailed tape specifications refer to packaging information: www.vishay.com/doc?28139
- (1) For further packaging see table "Composition of Catalog Number"
- (2) Further information about packaging quantities with different lead length and/or taped versions, see document "Packing Quantities" www.vishay.com/doc?27608
- (3) Weight for short lead product only

APPROVALS			
SAFETY APPROVALS X2	VOLTAGE	VALUE	FILE NUMBERS
EN 60384-14 (ENEC) (= IEC 60384-14 ed 3)	310 V _{AC}	0.01 μF to 2.2 μF X2	40005079
UL 60384-14	310 V _{AC}	0.01 μF to 2.2 μF X2	E354331
CSA-E 384-14	310 V _{AC}	0.01 μF to 2.2 μF X2	E354331
CB test-certificate	310 V _{AC}	0.01 μF to 2.2 μF X2	DE 1-40110/A1
The ENEC-approval together with the CB-certificate replace all national marks of the following countries (they have already signed the ENEC-agreement): Austria; Belgium; Czech. Republic; Denmark; Finland; France; Germany; Greece; Hungary; Ireland; Italy; Luxembourg; Netherlands; Norway; Portugal; Slovenian; Spain; Sweden; Switzerland and United Kingdom.			

**MOUNTING****Normal Use**

The capacitors are designed for mounting on printed-circuit boards. The capacitors packed in bandoliers are designed for mounting in printed-circuit boards by means of automatic insertion machines.

For detailed tape specifications refer to packaging information: www.vishay.com/doc?28139.

Specific Method of Mounting to Withstand Vibration and Shock

In order to withstand vibration and shock tests, it must be ensured that stand-off pips are in good contact with the printed-circuit board:

- For pitches ≤ 15 mm capacitors shall be mechanically fixed by the leads
- For larger pitches the capacitors shall be mounted in the same way and the body clamped

Space Requirements on Printed Circuit Board

The maximum space for length ($l_{max.}$), width ($w_{max.}$) and height ($h_{max.}$) of film capacitors to take in account on the printed circuit board is shown in the drawings.

- For products with pitch ≤ 15 mm, $\Delta w = \Delta l = 0.3$ mm; $\Delta h = 0.1$ mm
- For products with 15 mm $<$ pitch ≤ 27.5 mm, $\Delta w = \Delta l = 0.5$ mm; $\Delta h = 0.1$ mm
- For products with pitch = 37.5 mm, $\Delta w = \Delta l = 0.7$ mm; $\Delta h = 0.5$ mm

Eccentricity defined as in drawing. The maximum eccentricity is smaller than or equal to the lead diameter of the product concerned.

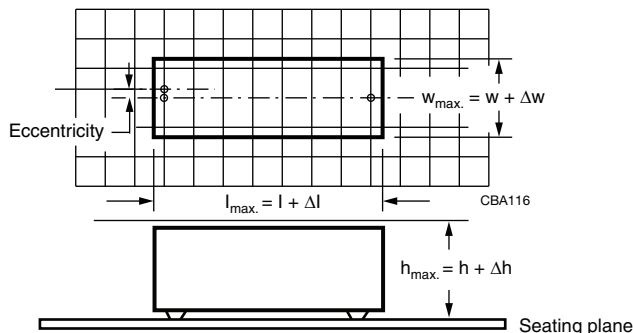
**SOLDERING CONDITIONS**

For general soldering conditions and wave soldering profile, we refer to the application note: "Soldering Guidelines for Film Capacitors": www.vishay.com/doc?28171

Storage Temperature

$T_{stg} = -25$ °C to $+35$ °C with RH maximum 75 % without condensation

Ratings and Characteristics Reference Conditions

Unless otherwise specified, all electrical values apply to an ambient temperature of 23 °C ± 1 °C, an atmospheric pressure of 86 kPa to 106 kPa and a relative humidity of 50 % ± 2 %.

For reference testing, a conditioning period shall be applied over 96 h ± 4 h by heating the products in a circulating air oven at the rated temperature and a relative humidity not exceeding 20 %.



CHARACTERISTICS

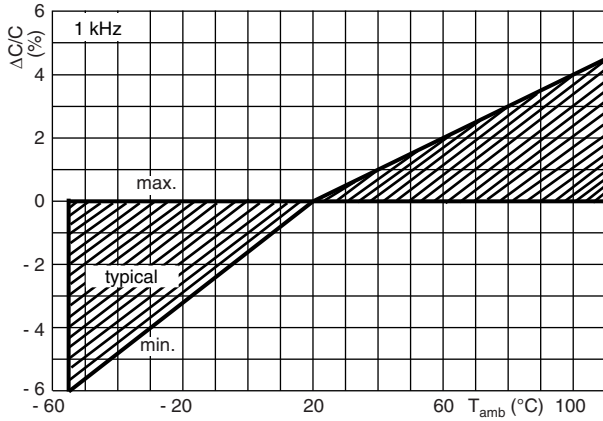

Capacitance as a function of ambient temperature (typical curve)

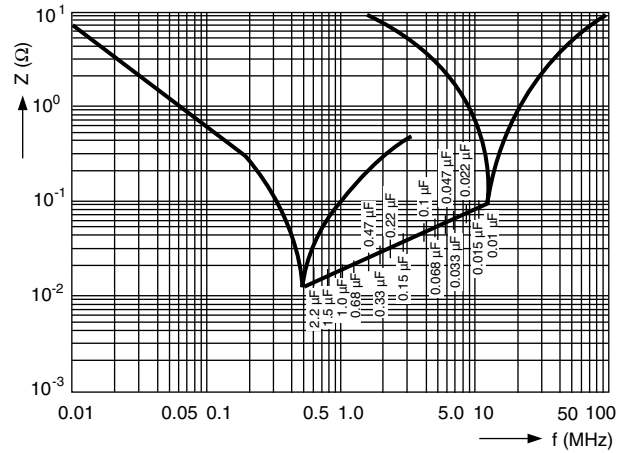

Impedance as a function of frequency (typical curve)

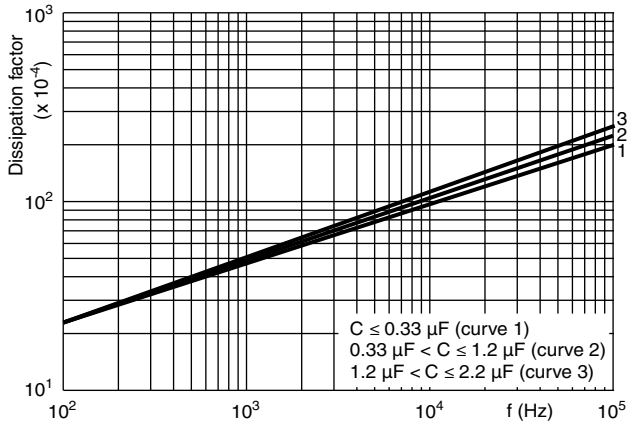

Tangent of loss angle as a function of frequency (typical curve)

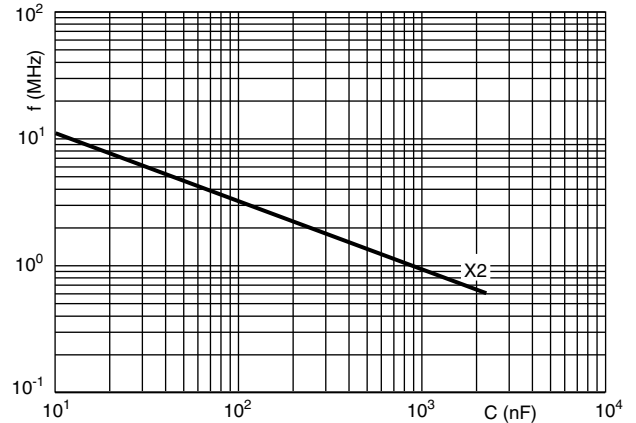

Resonant frequency as a function of capacitance (typical curve)

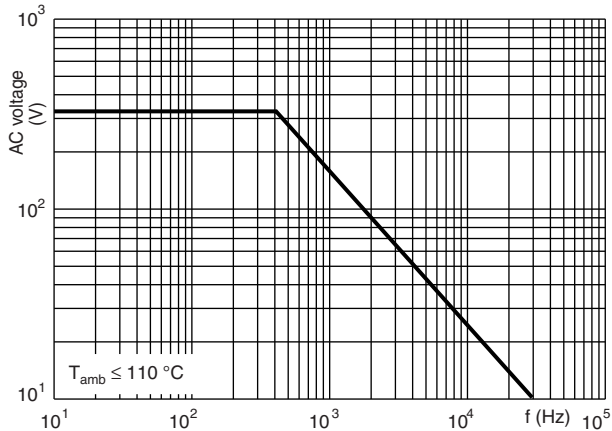

Max. RMS voltage as a function of frequency

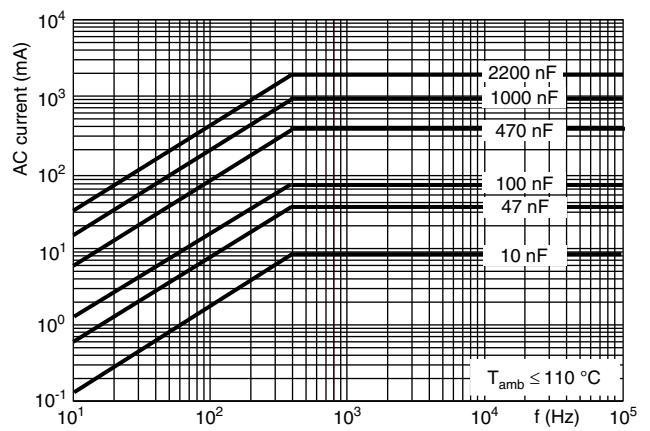

Max. RMS current as a function of frequency

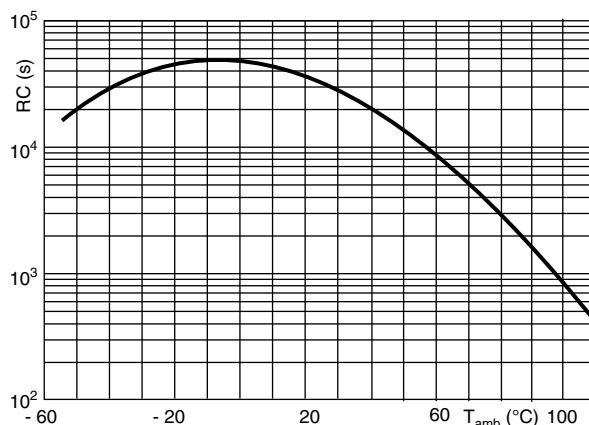

Insulation resistance as a function of ambient temperature (typical curve)

APPLICATION NOTES AND LIMITING CONDITIONS

- For X2 electromagnetic interference suppression where a higher stability grade is needed for **continuous across the line applications** (50 Hz/60 Hz) with a maximum mains voltage of 300 V_{AC}.
- These capacitors are not intended for continuous pulse application. For these situations capacitors of the AC and pulse programs must be used.
- For series impedance applications we refer to application note: www.vishay.com/doc?28153
- The maximum ambient temperature must not exceed 100 °C.
- Rated voltage pulse slope:
If the pulse voltage is lower than the rated voltage, the values of the specific reference data can be multiplied by 435 V_{DC} and divided by the applied voltage.

INSPECTION REQUIREMENTS

General Notes

Sub-clause numbers of tests and performance requirements refer to the “Sectional Specification, Publication IEC 60384-14 ed 3 and Specific Reference Data”.

GROUP C INSPECTION REQUIREMENTS		
SUB-CLAUSE NUMBER AND TEST	CONDITIONS	PERFORMANCE REQUIREMENTS
SUB-GROUP C1A PART OF SAMPLE OF SUB-GROUP C1		
4.1 Dimensions (detail)		As specified in chapter “General Data” of this specification
Initial measurements	Capacitance Tangent of loss angle: For C ≤ 1 μF at 10 kHz For C > 1 μF at 1 kHz	
4.3 Robustness of terminations	Tensile: Load 10 N; 10 s Bending: Load 5 N; 4 x 90°	No visible damage
4.4 Resistance to soldering heat	No pre-drying Method: 1A Solder bath: 280 °C ± 5 °C Duration: 10 s	



GROUP C INSPECTION REQUIREMENTS		
SUB-CLAUSE NUMBER AND TEST	CONDITIONS	PERFORMANCE REQUIREMENTS
SUB-GROUP C1A PART OF SAMPLE OF SUB-GROUP C1		
4.19 Component solvent resistance	Isopropylalcohol at room temperature Method: 2 Immersion time: 5 min ± 0.5 min Recovery time: Min. 1 h, max. 2 h	
4.4.2 Final measurements	Visual examination Capacitance Tangent of loss angle Insulation resistance	No visible damage Legible marking $ \Delta C/C \leq 5\%$ of the value measured initially Increase of $\tan \delta$ ≤ 0.008 for: $C \leq 1 \mu\text{F}$ or ≤ 0.005 for: $C > 1 \mu\text{F}$ Compared to values measured initially As specified in section "Insulation Resistance" of this specification
SUB-GROUP C1B PART OF SAMPLE OF SUB-GROUP C1		
Initial measurements	Capacitance Tangent of loss angle: For $C \leq 1 \mu\text{F}$ at 10 kHz For $C > 1 \mu\text{F}$ at 1 kHz	
4.20 Solvent resistance of the marking	Isopropylalcohol at room temperature Method: 1 Rubbing material: Cotton wool Immersion time: 5 min ± 0.5 min	No visible damage Legible marking
4.6 Rapid change of temperature	$\theta A = -40\text{ }^\circ\text{C}$ $\theta B = +100\text{ }^\circ\text{C}$ 5 cycles Duration $t = 30$ min	
4.6.1 Inspection	Visual examination	No visible damage
4.7 Vibration	Mounting: See section "Mounting" of this specification Procedure B4 Frequency range: 10 Hz to 55 Hz Amplitude: 0.75 mm or Acceleration 98 m/s^2 (whichever is less severe) Total duration 6 h	
4.7.2 Final inspection	Visual examination	No visible damage
4.9 Shock	Mounting: See section "Mounting" for more information Pulse shape: Half sine Acceleration: 490 m/s^2 Duration of pulse: 11 ms	
4.9.2 Final measurements	Visual examination Capacitance Tangent of loss angle Insulation resistance	No visible damage $ \Delta C/C \leq 5\%$ of the value measured initially Increase of $\tan \delta$ ≤ 0.008 for: $C \leq 1 \mu\text{F}$ or ≤ 0.005 for: $C > 1 \mu\text{F}$ Compared to values measured initially As specified in section "Specific Reference" of this specification



GROUP C INSPECTION REQUIREMENTS		
SUB-CLAUSE NUMBER AND TEST	CONDITIONS	PERFORMANCE REQUIREMENTS
SUB-GROUP C1 COMBINED SAMPLE OF SPECIMENS OF SUB-GROUPS C1A AND C1B		
4.11 Climatic sequence	Capacitance	
4.11.1 Initial measurements	Measured in 4.4.2 and 4.9.2 Tangent of loss angle Measured initially in C1A and C1B	
4.11.2 Dry heat	Temperature: 100 °C Duration: 16 h	
4.11.3 Damp heat cyclic Test Db, first cycle		
4.11.4 Cold	Temperature: - 40 °C Duration: 2 h	
4.11.5 Damp heat cyclic Test Db, remaining cycles		
4.11.6 Final measurements	Visual examination	No visible damage Legible marking
	Capacitance	$ \Delta C/C \leq 5\%$ of the value measured in 4.11.1
	Tangent of loss angle	Increase of $\tan \delta$ ≤ 0.008 for: $C \leq 1 \mu\text{F}$ or ≤ 0.005 for: $C > 1 \mu\text{F}$ Compared to values measured in 4.11.1
	Voltage proof 1350 V _{DC} 1 min between terminations	No permanent breakdown or flash-over
	Insulation resistance	$\geq 50\%$ of values specified in section "Insulation Resistance" of this specification
SUB-GROUP C2		
4.12 Damp heat steady state	56 days, 40 °C, 90 % to 95 % RH No load	
4.12.1 Initial measurements	Capacitance Tangent of loss angle: 1 kHz	
4.12.3 Final measurements	Visual examination	No visible damage Legible marking
	Capacitance	$ \Delta C/C \leq 5\%$ of the value measured in 4.12.1
	Tangent of loss angle	Increase of $\tan \delta$ ≤ 0.008 for: $C \leq 1 \mu\text{F}$ or ≤ 0.005 for: $C > 1 \mu\text{F}$ Compared to values measured in 4.12.1
	Voltage proof 1350 V _{DC} ; 1 min between terminations	No permanent breakdown or flash-over
	Insulation resistance	$\geq 50\%$ of values specified in section "Insulation Resistance" of this specification



GROUP C INSPECTION REQUIREMENTS		
SUB-CLAUSE NUMBER AND TEST	CONDITIONS	PERFORMANCE REQUIREMENTS
SUB-GROUP C3		
4.13.1 Initial measurements	Capacitance Tangent of loss angle: For C ≤ 1 μF at 10 kHz For C > 1 μF at 1 kHz	
4.13 Impulse voltage	3 successive impulses, full wave, peak voltage: X2: 2.5 kV for C ≤ 1 μF X2: 2.5 kV/√C for C > 1 μF Max. 24 pulses	No self healing breakdowns or flash-over
4.14 Endurance	Duration: 1000 h 1.25 x U _{RAC} at 100 °C Once in every hour the voltage is increased to 1000 V (RMS) for 0.1 s via resistor of 47 Ω ± 5 %	
4.14.7 Final measurements	Visual examination Capacitance Tangent of loss angle Voltage proof 1350 V _{DC} ; 1 min between terminations 2500 V _{AC} ; 2 s at 25 °C between terminations and case Insulation resistance	No visible damage Legible marking ΔC/C ≤ 5 % compared to values measured in 4.13.1 Increase of tan δ ≤ 0.008 for: C ≤ 1 μF or ≤ 0.005 for: C > 1 μF Compared to values measured in 4.13.1 No permanent breakdown or flash-over ≥ 50 % of values specified in section "Insulation Resistance" of this specification
SUB-GROUP C4		
4.15 Charge and discharge	10 000 cycles Charged to 435 V _{DC} Discharge resistance: $R = \frac{435 V_{DC}}{1.5 \times C(dU/dt)}$	
4.15.1 Initial measurements	Capacitance Tangent of loss angle: For C ≤ 1 μF at 10 kHz For C > 1 μF at 1 kHz	
4.13.3 Final measurements	Capacitance Tangent of loss angle Insulation resistance	ΔC/C ≤ 10 % compared to values measured in 4.15.1 Increase of tan δ ≤ 0.008 for: C ≤ 1 μF or ≤ 0.005 for: C > 1 μF Compared to values measured in 4.15.1 ≥ 50 % of values specified in section "Insulation Resistance" of this specification

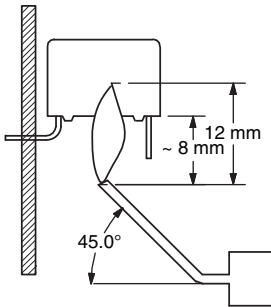

GROUP C INSPECTION REQUIREMENTS		
SUB-CLAUSE NUMBER AND TEST	CONDITIONS	PERFORMANCE REQUIREMENTS
SUB-GROUP C5		
4.16 Radio frequency characteristic	Resonance frequency	≥ 0.9 times the value as specified in section "Resonant Frequency" of this specification.
SUB-GROUP C6		
4.17 Passive flammability Class C	Bore of gas jet: $\varnothing 0.5$ mm Fuel: Butane Test duration for actual volume V in mm ³ : $V \leq 250$: 5 s $250 < V \leq 500$: 10 s $500 < V \leq 1750$: 20 s $V > 1750$: 30 s One flame application 	After removing test flame from capacitor, the capacitor must not continue to burn for more than 30 s. No burning particle must drop from the sample.
SUB-GROUP C7		
4.18 Active flammability	20 cycles of 2.5 kV discharges on the test capacitor connected to U_{RAC} .	The cheese cloth around the capacitors shall not burn with a flame. No electrical measurements are required.



Disclaimer

ALL PRODUCT, PRODUCT SPECIFICATIONS AND DATA ARE SUBJECT TO CHANGE WITHOUT NOTICE TO IMPROVE RELIABILITY, FUNCTION OR DESIGN OR OTHERWISE.

Vishay Intertechnology, Inc., its affiliates, agents, and employees, and all persons acting on its or their behalf (collectively, "Vishay"), disclaim any and all liability for any errors, inaccuracies or incompleteness contained in any datasheet or in any other disclosure relating to any product.

Vishay makes no warranty, representation or guarantee regarding the suitability of the products for any particular purpose or the continuing production of any product. To the maximum extent permitted by applicable law, Vishay disclaims (i) any and all liability arising out of the application or use of any product, (ii) any and all liability, including without limitation special, consequential or incidental damages, and (iii) any and all implied warranties, including warranties of fitness for particular purpose, non-infringement and merchantability.

Statements regarding the suitability of products for certain types of applications are based on Vishay's knowledge of typical requirements that are often placed on Vishay products in generic applications. Such statements are not binding statements about the suitability of products for a particular application. It is the customer's responsibility to validate that a particular product with the properties described in the product specification is suitable for use in a particular application. Parameters provided in datasheets and / or specifications may vary in different applications and performance may vary over time. All operating parameters, including typical parameters, must be validated for each customer application by the customer's technical experts. Product specifications do not expand or otherwise modify Vishay's terms and conditions of purchase, including but not limited to the warranty expressed therein.

Except as expressly indicated in writing, Vishay products are not designed for use in medical, life-saving, or life-sustaining applications or for any other application in which the failure of the Vishay product could result in personal injury or death. Customers using or selling Vishay products not expressly indicated for use in such applications do so at their own risk. Please contact authorized Vishay personnel to obtain written terms and conditions regarding products designed for such applications.

No license, express or implied, by estoppel or otherwise, to any intellectual property rights is granted by this document or by any conduct of Vishay. Product names and markings noted herein may be trademarks of their respective owners.



Компания «ЭлектроПласт» предлагает заключение долгосрочных отношений при поставках импортных электронных компонентов на взаимовыгодных условиях!

Наши преимущества:

- Оперативные поставки широкого спектра электронных компонентов отечественного и импортного производства напрямую от производителей и с крупнейших мировых складов;
- Поставка более 17-ти миллионов наименований электронных компонентов;
- Поставка сложных, дефицитных, либо снятых с производства позиций;
- Оперативные сроки поставки под заказ (от 5 рабочих дней);
- Экспресс доставка в любую точку России;
- Техническая поддержка проекта, помощь в подборе аналогов, поставка прототипов;
- Система менеджмента качества сертифицирована по Международному стандарту ISO 9001;
- Лицензия ФСБ на осуществление работ с использованием сведений, составляющих государственную тайну;
- Поставка специализированных компонентов (Xilinx, Altera, Analog Devices, Intersil, Interpoint, Microsemi, Aeroflex, Peregrine, Syfer, Eurofarad, Texas Instrument, Miteq, Cobham, E2V, MA-COM, Hittite, Mini-Circuits, General Dynamics и др.);

Помимо этого, одним из направлений компании «ЭлектроПласт» является направление «Источники питания». Мы предлагаем Вам помощь Конструкторского отдела:

- Подбор оптимального решения, техническое обоснование при выборе компонента;
- Подбор аналогов;
- Консультации по применению компонента;
- Поставка образцов и прототипов;
- Техническая поддержка проекта;
- Защита от снятия компонента с производства.



Как с нами связаться

Телефон: 8 (812) 309 58 32 (многоканальный)

Факс: 8 (812) 320-02-42

Электронная почта: org@eplast1.ru

Адрес: 198099, г. Санкт-Петербург, ул. Калинина, дом 2, корпус 4, литера А.