







Cylindrical 16-dia. Indicator

- Same basic design as the A16 Pushbutton Switch.

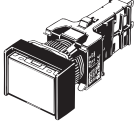

 Refer to *Safety Precautions for All Pushbutton Switches and Safety Precautions* on page 11.

List of Models

| | Appearance | Model |
|----------------------------|--|-------|
| Solder terminals | Rectangular  | M16-J |
| | Square  | M16-A |
| | Round  | M16-T |
| Voltage-reduction lighting |  | M16-□ |
| Screw-less Clamp |  | M16-□ |

Model Number Structure

Model Number Legend The model numbers used to order sets of Units are illustrated below. One set comprises the Display, Case, Lamp, and Socket.

For information on combinations, refer to *Ordering Information* on the following pages.

(1)
(2)
(3)
(4)
(5)
M 1 6 5 - T R - 24D - S

(1) Degree of Protection

| Symbol | Protection |
|-----------|--------------------|
| No symbol | IP40 |
| 5 | IP65 oil-resistant |

(2) Shape of Display

| Symbol | Shape |
|--------|-------------|
| J | Rectangular |
| A | Square |
| T | Round |

(3) Color of Display

| Symbol | Color |
|--------|-------------|
| R | Red |
| G | Green |
| Y | Yellow |
| PY | Pure yellow |
| W | White |
| PW | Pure white |
| A | Blue |

(4) Light Source

| Symbol | Type | Operating voltage | Rated voltage |
|------------------|-------------------|-------------------|---------------|
| 5 12 24 | Incandescent lamp | 5 VAC/VDC | 6 VAC/VDC |
| | | 12 VAC/VDC | 14 VAC/VDC |
| | | 24 VAC/VDC | 28 VAC/VDC |
| 5D 12D 24D | LED | 5 ±5% VDC | 5 VDC |
| | | 12 ±5% VAC/VDC | 12 VAC/VDC |
| | | 24 ±5% VAC/VDC | 24 VAC/VDC |

(5) Terminal Type

| Symbol | Terminal type |
|-----------|------------------|
| No symbol | Solder terminals |
| S | Screw-less Clamp |

Voltage Reduction Unit (24-V Built-in LED)

| Symbol | Type | Operating voltage | Rated voltage |
|--------|------|-------------------|---------------|
| T1 | LED | 100/110 VAC/VDC | 110 VAC/VDC |
| T2 | | 200/220 VAC/VDC | 220 VAC/VDC |

- Color illuminated models are also available (see page 4).
- Order the parts separately.
- Solder terminals are available only with 100-V models.
- Screw-less clamp connectors are used for 200-V models.

Sets Select an Operation Unit Set (Operation Unit and Case) and a Socket Unit Set (Lamp and Socket Unit).



Ordering Information

Ordering as a Set The model numbers used to order sets of Units are given in the following tables. One set comprises the Display, Case, Lamp, and Socket.

M16□-J (Rectangular) Models

Solder Terminal Models

| Appearance | Lighting | Degree of protection | IP40 | IP65 oil-resistant | Display color symbol * |
|--|------------------------------------|----------------------|-------------------|--------------------|---|
| Rectangular (M16-J)  | LED without Voltage Reduction Unit | 5 VDC | M16-J□-5D | M165-J□-5D | R: red Y: yellow G: green A: blue W: white PY: pure yellow PW: pure white |
| | | 12 VAC/VDC | M16-J□-12D | M165-J□-12D | |
| | | 24 VAC/VDC | M16-J□-24D | M165-J□-24D | |
| | Incandescent lamp | 5 VAC/VDC | M16-J□-5 | M165-J□-5 | R: red Y: yellow G: green A: blue W: white PY: pure yellow |
| | | 12 VAC/VDC | M16-J□-12 | M165-J□-12 | |
| | | 24 VAC/VDC | M16-J□-24 | M165-J□-24 | |

* Enter the desired color symbol into the box in the model number.

M16□-A (Square) Models

Solder Terminal Models

| Appearance | Lighting | Degree of protection | IP40 | IP65 oil-resistant | Display color symbol * |
|---|------------------------------------|----------------------|-------------------|--------------------|---|
| Square (M16-A)  | LED without Voltage Reduction Unit | 5 VDC | M16-A□-5D | M165-A□-5D | R: red Y: yellow G: green A: blue W: white PY: pure yellow PW: pure white |
| | | 12 VAC/VDC | M16-A□-12D | M165-A□-12D | |
| | | 24 VAC/VDC | M16-A□-24D | M165-A□-24D | |
| | Incandescent lamp | 5 VAC/VDC | M16-A□-5 | M165-A□-5 | R: red Y: yellow G: green A: blue W: white PY: pure yellow |
| | | 12 VAC/VDC | M16-A□-12 | M165-A□-12 | |
| | | 24 VAC/VDC | M16-A□-24 | M165-A□-24 | |

* Enter the desired color symbol into the box in the model number.

M16□-T (Round) Models

Solder Terminal Models

| Appearance | Lighting | Degree of protection | IP40 | IP65 oil-resistant | Display color symbol * |
|--|------------------------------------|----------------------|-------------------|--------------------|---|
| Round (M16-T)  | LED without Voltage Reduction Unit | 5 VDC | M16-T□-5D | M165-T□-5D | R: red Y: yellow G: green A: blue W: white PY: pure yellow PW: pure white |
| | | 12 VAC/VDC | M16-T□-12D | M165-T□-12D | |
| | | 24 VAC/VDC | M16-T□-24D | M165-T□-24D | |
| | Incandescent lamp | 5 VAC/VDC | M16-T□-5 | M165-T□-5 | R: red Y: yellow G: green A: blue W: white PY: pure yellow |
| | | 12 VAC/VDC | M16-T□-12 | M165-T□-12 | |
| | | 24 VAC/VDC | M16-T□-24 | M165-T□-24 | |

Note: Neon lamps are not available with models that are ordered as a set. They must be ordered individually if required.



* Enter the desired color symbol into the box in the model number.

Individual models: Refer to pages 4 to 7.
(The Display, Lamp, Case, and Switch can be ordered separately.)

- Accessories, replacements, and tools: Refer to the A16.
- Ratings and characteristics: Refer to the A16.
- Dimensions: Refer to pages 9 to 10.

Ordering Information

Ordering IndividuallyDisplays, Cases, Lamps, and Sockets can be ordered separately. Combinations that are not available as sets can be created using individual parts. Also, store the parts as spares for maintenance and repairs.

| Display (Refer to page 6.) | | |
|---|---|---|
| Rectangular | Square | Round |
|  |  |  |

Note: Use IP40 Displays in combination with IP40 Sockets and use IP65 Displays in combination with IP65 Sockets. The Display has a legend plate built in.



| Case (Refer to page 7.) |
|--|
|  |
| Note: Display Units, which are combinations of Displays and Cases, are also available. |



Lighted Models



| Lamp (Refer to page 7.) | |
|---|---|
| LED | Incandescent Lamp |
|  |  |



| Socket (Refer to page 7.) |
|--|
| Solder Terminals (Without Voltage Reduction Unit) |
|  |
| Note: Socket Units, which are combinations of Lamps and Sockets, are also available. |

- For colored illumination, order the Display, Case, Lamp, and Socket Unit separately.

Ordering Information

Sets..... Sets that combined a Display and Cases are also available.

Display Set

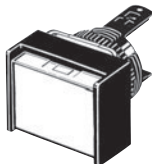
| Appearance | Classification | | Model |
|---|--------------------|---------------------------|-----------------|
|  | IP40 | Rectangular (2-way guard) | A16-J□M |
| | | Square (2-way guard) | A16-A□M |
| | | Round (projecting model) | A16-T□M |
| | Oil-resistant IP65 | Rectangular (2-way guard) | A165-J□M |
| | | Square (2-way guard) | A165-A□M |
| | | Round (projecting model) | A165-T□M |

Insert one of the following symbols into the box in the model number.

| Symbol | Color | Remarks |
|--------|-------------|----------------------------|
| R | Red | LED and incandescent lamps |
| Y | Yellow | |
| PY | Pure yellow | |
| A | Blue | |
| W | White* | |
| GY | Green | LED only |
| G | Green | Incandescent only |

* Use this pushbutton color if the illumination color of the LED is white or pure white.

Socket Unit Sets with Incandescent Lamps

| Appearance | Classification | | Model |
|---|----------------|------------------|---------------|
|  | 5 V | Solder terminals | M16-5 |
| | 12 V | | M16-12 |
| | 24 V | | M16-24 |

Socket Unit Sets with LEDs

| Appearance | Classification | Model |
|---|------------------|----------------|
|  | Solder terminals | M16-1-2 |

Socket Unit Sets with Voltage-reduction Lighting (Solder Terminals)

| Appearance | Classification | Model |
|---|-----------------|-----------------|
|  | 100/110 VAC/VDC | M16-1-T1 |

Note: The LED has 24-VAC/VDC circuit built in.

Socket Unit Sets with Screw-less Clamp Connectors

| Appearance | Classification | | Model | |
|---|----------------|--|------------------|-------------------|
|  | Display | No voltage-reduction lighting | M16-1-2-S | |
| | | Voltage-reduction lighting (See note.) | 100/110 VAC/VDC | M16-1-T1-S |
| | | | 200/220 VAC/VDC | M16-1-T2-S |

Note: 1. The LED built into the 100-V model is 24 VAC/VDC.

2. The LED built into the 200-V model is high-intensity 24 VAC/VDC.

Insert symbols into the boxes with circled numbers.

1

| Symbol | Color |
|--------|--------|
| R | Red |
| Y | Yellow |
| A | Blue |
| W | White |
| G | Green |

2







| Symbol | Type | Operating voltage |
|--------|------|-------------------|
| 5D | LED | 5 VDC |
| 12D | | 12 VAC/VDC |
| 24D | | 24 VAC/VDC |

Ordering Information







Ordering IndividuallyDisplays, Cases, Lamps, and Sockets can be ordered separately. Combinations that are not available as sets can be created using individual parts. Also, store the parts as spares for maintenance and repairs.

Display

For LED-lighted Models

| Sealing | IP40 | | | IP65 oil-resistant | | |
|------------------|---|---|---|--|---|---|
| | Rectangular | Square | Round | Rectangular | Square | Round |
| Appearance |  |  |  |  |  |  |
| Color of Display | | | | | | |
| Red | A16L-JR | A16L-AR | A16L-TR | A165L-JR | A165L-AR | A165L-TR |
| Yellow | A16L-JY | A16L-AY | A16L-TY | A165L-JY | A165L-AY | A165L-TY |
| Pure yellow | A16L-JPY | A16L-APY | A16L-TPY | A165L-JPY | A165L-APY | A165L-TPY |
| Green | A16L-JGY | A16L-AGY | A16L-TGY | A165L-JGY | A165L-AGY | A165L-TGY |
| White | A16L-JW | A16L-AW | A16L-TW | A165L-JW | A165L-AW | A165L-TW |
| Blue | A16L-JA | A16L-AA | A16L-TA | A165L-JA | A165L-AA | A165L-TA |

Incandescent Lamps (With the exception of green, the Units are the same as for LEDs.)

| Sealing | IP40 | | | IP65 oil-resistant | | |
|------------------|---|---|---|--|---|---|
| | Rectangular | Square | Round | Rectangular | Square | Round |
| Appearance |  |  |  |  |  |  |
| Color of Display | | | | | | |
| Red | A16L-JR | A16L-AR | A16L-TR | A165L-JR | A165L-AR | A165L-TR |
| Yellow | A16L-JY | A16L-AY | A16L-TY | A165L-JY | A165L-AY | A165L-TY |
| Pure yellow | A16L-JPY | A16L-APY | A16L-TPY | A165L-JPY | A165L-APY | A165L-TPY |
| Green | A16L-JG | A16L-AG | A16L-TG | A165L-JG | A165L-AG | A165L-TG |
| White | A16L-JW | A16L-AW | A16L-TW | A165L-JW | A165L-AW | A165L-TW |
| Blue | A16L-JA | A16L-AA | A16L-TA | A165L-JA | A165L-AA | A165L-TA |

Ordering set combinations: Refer to page 3.

- Accessories, replacements, and tools: Refer to the A16.
- Ratings and characteristics: Refer to the A16.
- Dimensions: Refer to pages 9 to 10.

Ordering Information

Ordering Individually Displays, Cases, Lamps, and Sockets can be ordered separately. Combinations that are not available as sets can be created using individual parts. Also, store the parts as spares for maintenance and repairs.

Lamp LED

| Color | Operating voltage | High intensity  | | |
|------------|-------------------|--|------------------|------------------|
| | | 5 VDC | 12 VAC/VDC | 24 VAC/VDC |
| Red | | A16-5DSR | A16-12DSR | A16-24DSR |
| Yellow | | A16-5DSY | A16-12DSY | A16-24DSY |
| Green | | A16-5DSG | A16-12DSG | A16-24DSG |
| White * | | A16-5DSW | A16-12DSW | A16-24DSW |
| Blue | | A16-5DA | A16-12DA | A16-24DA |
| Pure white | | A16-5DPW | A16-12DPW | A16-24DPW |

* Use the white LED when the required illumination color is white or pure yellow.

Incandescent Lamp

| Appearance | Operating voltage | Model |
|---|-------------------|---------------|
|  | 5 VAC/VDC | A16-5 |
| | 12 VAC/VDC | A16-12 |
| | 24 VAC/VDC | A16-24 |

Case

| Appearance | Classification | | Model number |
|--|--------------------|-------------|-----------------|
|  | IP40 | Rectangular | A16-CJM |
| | | Square | A16-CAM |
| | | Round | A16-CTM |
| | IP65 oil-resistant | Rectangular | A165-CJM |
| | | Square | A165-CAM |
| | | Round | A165-CTM |

Socket

| Appearance | Classification | | | Model number |
|---|------------------|----------------------------|-------|-----------------|
|  Solder terminals | Solder terminals | | | M16-0 |
| | PCB terminals | | | M16-0P |
| | Screw-Less Clamp | | | M16-S |
| | Solder terminals | Voltage-reduction lighting | 100 V | M16-T1 |
| | Screw-less Clamp | | 100 V | M16-T1-S |
| | | | 200 V | M16-T2-S |

Ordering set combinations: Refer to page 3.

- Accessories, replacements, and tools: Refer to the A16.
- Ratings and characteristics: Refer to the A16.
- Dimensions: Refer to pages 9 to 10.

Specifications

Approved Standard Ratings

UL, cUL (File No. E76675)

LED: 24 VDC max.

Incandescent lamp: 24 VDC/VAC max.

Note: Certification has been obtained for the Socket Unit.

For detailed information on individual products that have received certification, consult your supplier.

Ratings

| | |
|--------------------------------------|---|
| Ambient operating temperature | -10°C to 55°C (with no icing or condensation) |
| Ambient operating humidity | 35% to 85%RH |
| Ambient storage temperature | -25°C to 65°C (with no icing or condensation) |

Super-bright LED

| Rated voltage | Rated current | Operating voltage | Built-in limiting resistance |
|---------------|---------------|---------------------|---|
| 5 VDC | 8 mA | 5 VDC \pm 5% | Red, yellow, white: 300 Ω Green, blue, pure white: 160 Ω |
| 12 VAC/VDC | | 12 VAC/VDC \pm 5% | Red, yellow, white: 1 k Ω Green, blue, pure white: 910 Ω |
| 24 VAC/VDC | | 24 VAC/VDC \pm 5% | 2.4 k Ω |

Incandescent Lamp

| Rated voltage | Rated current | Operating voltage |
|---------------|---------------|-------------------|
| 6 VAC/VDC | 60 mA | 5 VAC/VDC |
| 14 VAC/VDC | 40 mA | 12 VAC/VDC |
| 28 VAC/VDC | 24 mA | 24 VAC/VDC |

Characteristics

Screw-less Clamp

| Item | Type | Screw-less Clamp | | | |
|--|-------------------------|--|---------------------|----------------------|----------------------|
| Recommended wire size | | 0.5 mm ² twisted wire or 0.8 mm-dia. solid wire | | | |
| Usable wires and tensile strength | Twisted wire | 0.3 mm ² | 0.5 mm ² | 0.75 mm ² | 1.25 mm ² |
| | Solid wire | 0.5 mm dia. | 0.8 mm dia. | 1.0 mm dia. | --- |
| | Tensile strength | 10 N | 20 N | 30 N | 40 N |
| Length of exposed wire | | 10 \pm 1 mm | | | |
| Compliant standards | | JIS C 2811 Terminal Blocks for Industrial Use | | | |

Dimensions (Refer to the A16 for details of panel cutout dimensions.)

(Unit: mm)

Rectangular

M16□-J

Solder terminals



Square

M16□-A

Solder terminals



Round

M16□-T

Solder terminals

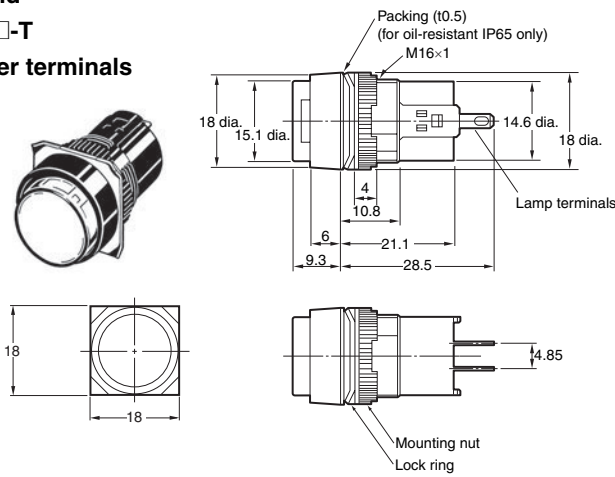

Terminal Hole Dimensions



Dimensions

Rectangular

M16□-J□-T1

Voltage-reduction lighting,
solder terminals



Rectangular

M16□-J□-S

Screw-less Clamp



Dimensions

(All units are in millimeters unless otherwise indicated.)

Terminal Arrangement

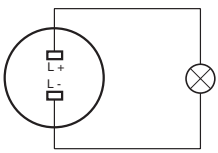
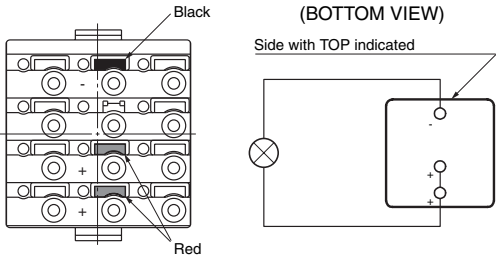
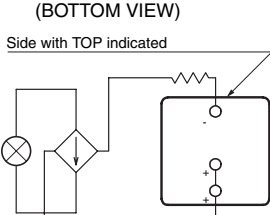
| Solder Terminals | Screw-less Clamp | Voltage-reduction Lighting |
|---|--|--|
| <p>(BOTTOM VIEW)</p>  <p>The L+ is not shown on the Socket Unit.</p> | <p>(BOTTOM VIEW)</p> <p>Side with TOP indicated</p>  | <p>(BOTTOM VIEW)</p> <p>Side with TOP indicated</p>  <p>Models with voltage-reduction lighting have a circuit to reduce voltage built in.</p> |

Accessories, Replacements, and Tools

The accessories, replacements, and tools are also used with the A16 Pushbutton Switch. Refer to the A16 datasheet.

Safety Precautions

Refer to *Safety Precautions for All Pushbutton Switches* and *Safety Precautions for the A16*.

Precautions for Correct Use

Mounting

- When mounting the Case onto the Socket Unit, ensure that the orientation is correct. Perform mounting with the dimple on the Case and the TOP mark on the Socket Unit facing in the same direction.

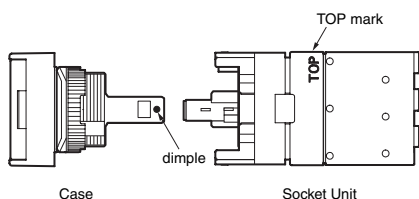

Wiring

- When using stranded wire, gather the ends of the strands together before wiring.
- When wiring, insert the wire until it comes into contact with something. After wiring is completed, pull on the wires to confirm that they are connected securely.
- After wiring, ensure that continuous pressure is not applied to the terminals.
- Refer to internal connections diagrams and confirm the terminal numbers before performing wiring.

Screw-less Clamps

Mounting Procedure

- Strip a length of 10 mm off the end of the wire (allowable range: 10 ± 1 mm).
- Bunch wire strands together and straighten them.
- Insert the wire into the insertion hole while pressing the release button at the side of the hole. (Using a precision screwdriver is recommended.)
- Let go of the release button to lock the wire into place.
- After locking, pull on the wire gently to confirm that it is securely locked.

Removing Procedure

- Remove wires by pulling them while pressing the release button.

Note: When reusing wires that have already been locked, cut off the end of the wire and strip the wire again before using.

Read and Understand This Catalog

Please read and understand this catalog before purchasing the products. Please consult your OMRON representative if you have any questions or comments.

Warranty and Limitations of Liability

WARRANTY

OMRON's exclusive warranty is that the products are free from defects in materials and workmanship for a period of one year (or other period if specified) from date of sale by OMRON.

OMRON MAKES NO WARRANTY OR REPRESENTATION, EXPRESS OR IMPLIED, REGARDING NON-INFRINGEMENT, MERCHANTABILITY, OR FITNESS FOR PARTICULAR PURPOSE OF THE PRODUCTS. ANY BUYER OR USER ACKNOWLEDGES THAT THE BUYER OR USER ALONE HAS DETERMINED THAT THE PRODUCTS WILL SUITABLY MEET THE REQUIREMENTS OF THEIR INTENDED USE. OMRON DISCLAIMS ALL OTHER WARRANTIES, EXPRESS OR IMPLIED.

LIMITATIONS OF LIABILITY

OMRON SHALL NOT BE RESPONSIBLE FOR SPECIAL, INDIRECT, OR CONSEQUENTIAL DAMAGES, LOSS OF PROFITS OR COMMERCIAL LOSS IN ANY WAY CONNECTED WITH THE PRODUCTS, WHETHER SUCH CLAIM IS BASED ON CONTRACT, WARRANTY, NEGLIGENCE, OR STRICT LIABILITY.

In no event shall the responsibility of OMRON for any act exceed the individual price of the product on which liability is asserted.

IN NO EVENT SHALL OMRON BE RESPONSIBLE FOR WARRANTY, REPAIR, OR OTHER CLAIMS REGARDING THE PRODUCTS UNLESS OMRON'S ANALYSIS CONFIRMS THAT THE PRODUCTS WERE PROPERLY HANDLED, STORED, INSTALLED, AND MAINTAINED AND NOT SUBJECT TO CONTAMINATION, ABUSE, MISUSE, OR INAPPROPRIATE MODIFICATION OR REPAIR.

Application Considerations

SUITABILITY FOR USE

OMRON shall not be responsible for conformity with any standards, codes, or regulations that apply to the combination of products in the customer's application or use of the products.

At the customer's request, OMRON will provide applicable third party certification documents identifying ratings and limitations of use that apply to the products. This information by itself is not sufficient for a complete determination of the suitability of the products in combination with the end product, machine, system, or other application or use.

The following are some examples of applications for which particular attention must be given. This is not intended to be an exhaustive list of all possible uses of the products, nor is it intended to imply that the uses listed may be suitable for the products:

- Outdoor use, uses involving potential chemical contamination or electrical interference, or conditions or uses not described in this catalog.
- Nuclear energy control systems, combustion systems, railroad systems, aviation systems, medical equipment, amusement machines, vehicles, safety equipment, and installations subject to separate industry or government regulations.
- Systems, machines, and equipment that could present a risk to life or property.

Please know and observe all prohibitions of use applicable to the products.

NEVER USE THE PRODUCTS FOR AN APPLICATION INVOLVING SERIOUS RISK TO LIFE OR PROPERTY WITHOUT ENSURING THAT THE SYSTEM AS A WHOLE HAS BEEN DESIGNED TO ADDRESS THE RISKS, AND THAT THE OMRON PRODUCTS ARE PROPERLY RATED AND INSTALLED FOR THE INTENDED USE WITHIN THE OVERALL EQUIPMENT OR SYSTEM.

PROGRAMMABLE PRODUCTS

OMRON shall not be responsible for the user's programming of a programmable product, or any consequence thereof.

Disclaimers

CHANGE IN SPECIFICATIONS

Product specifications and accessories may be changed at any time based on improvements and other reasons.

It is our practice to change model numbers when published ratings or features are changed, or when significant construction changes are made. However, some specifications of the products may be changed without any notice. When in doubt, special model numbers may be assigned to fix or establish key specifications for your application on your request. Please consult with your OMRON representative at any time to confirm actual specifications of purchased products.

DIMENSIONS AND WEIGHTS

Dimensions and weights are nominal and are not to be used for manufacturing purposes, even when tolerances are shown.

PERFORMANCE DATA

Performance data given in this catalog is provided as a guide for the user in determining suitability and does not constitute a warranty. It may represent the result of OMRON's test conditions, and the users must correlate it to actual application requirements. Actual performance is subject to the OMRON Warranty and Limitations of Liability.

ERRORS AND OMISSIONS

The information in this document has been carefully checked and is believed to be accurate; however, no responsibility is assumed for clerical, typographical, or proofreading errors, or omissions.

2011.1

In the interest of product improvement, specifications are subject to change without notice.

OMRON Corporation
Industrial Automation Company

<http://www.ia.omron.com/>

(c)Copyright OMRON Corporation 2011 All Right Reserved.



Компания «ЭлектроПласт» предлагает заключение долгосрочных отношений при поставках импортных электронных компонентов на взаимовыгодных условиях!

Наши преимущества:

- Оперативные поставки широкого спектра электронных компонентов отечественного и импортного производства напрямую от производителей и с крупнейших мировых складов;
- Поставка более 17-ти миллионов наименований электронных компонентов;
- Поставка сложных, дефицитных, либо снятых с производства позиций;
- Оперативные сроки поставки под заказ (от 5 рабочих дней);
- Экспресс доставка в любую точку России;
- Техническая поддержка проекта, помощь в подборе аналогов, поставка прототипов;
- Система менеджмента качества сертифицирована по Международному стандарту ISO 9001;
- Лицензия ФСБ на осуществление работ с использованием сведений, составляющих государственную тайну;
- Поставка специализированных компонентов (Xilinx, Altera, Analog Devices, Intersil, Interpoint, Microsemi, Aeroflex, Peregrine, Syfer, Eurofarad, Texas Instrument, Miteq, Cobham, E2V, MA-COM, Hittite, Mini-Circuits, General Dynamics и др.);

Помимо этого, одним из направлений компании «ЭлектроПласт» является направление «Источники питания». Мы предлагаем Вам помощь Конструкторского отдела:

- Подбор оптимального решения, техническое обоснование при выборе компонента;
- Подбор аналогов;
- Консультации по применению компонента;
- Поставка образцов и прототипов;
- Техническая поддержка проекта;
- Защита от снятия компонента с производства.



Как с нами связаться

Телефон: 8 (812) 309 58 32 (многоканальный)

Факс: 8 (812) 320-02-42

Электронная почта: org@eplast1.ru

Адрес: 198099, г. Санкт-Петербург, ул. Калинина, дом 2, корпус 4, литера А.